

بِسْمِ اللّٰهِ الرَّحْمٰنِ الرَّحِیْمِ

New Model... Ctrl+N  
New Model from Template...  
Open ... Ctrl+O  
Save Ctrl+S  
Save As... F12

Import ▶  
Export ▶

Create Animation Video...

Print Setup... Ctrl+P  
Print Preview for Graphics...  
Print Graphics Ctrl+G  
Print Input Tables... Ctrl+I  
Print Output Tables... Ctrl+B  
Print Design Tables... Ctrl+D

Capture Enhanced Metafile ▶  
Capture Picture ▶

User Comments and Session Log...  
Display Input/Output Text Files...

F:\Safe work\11.FDB

Exit Shift+F4

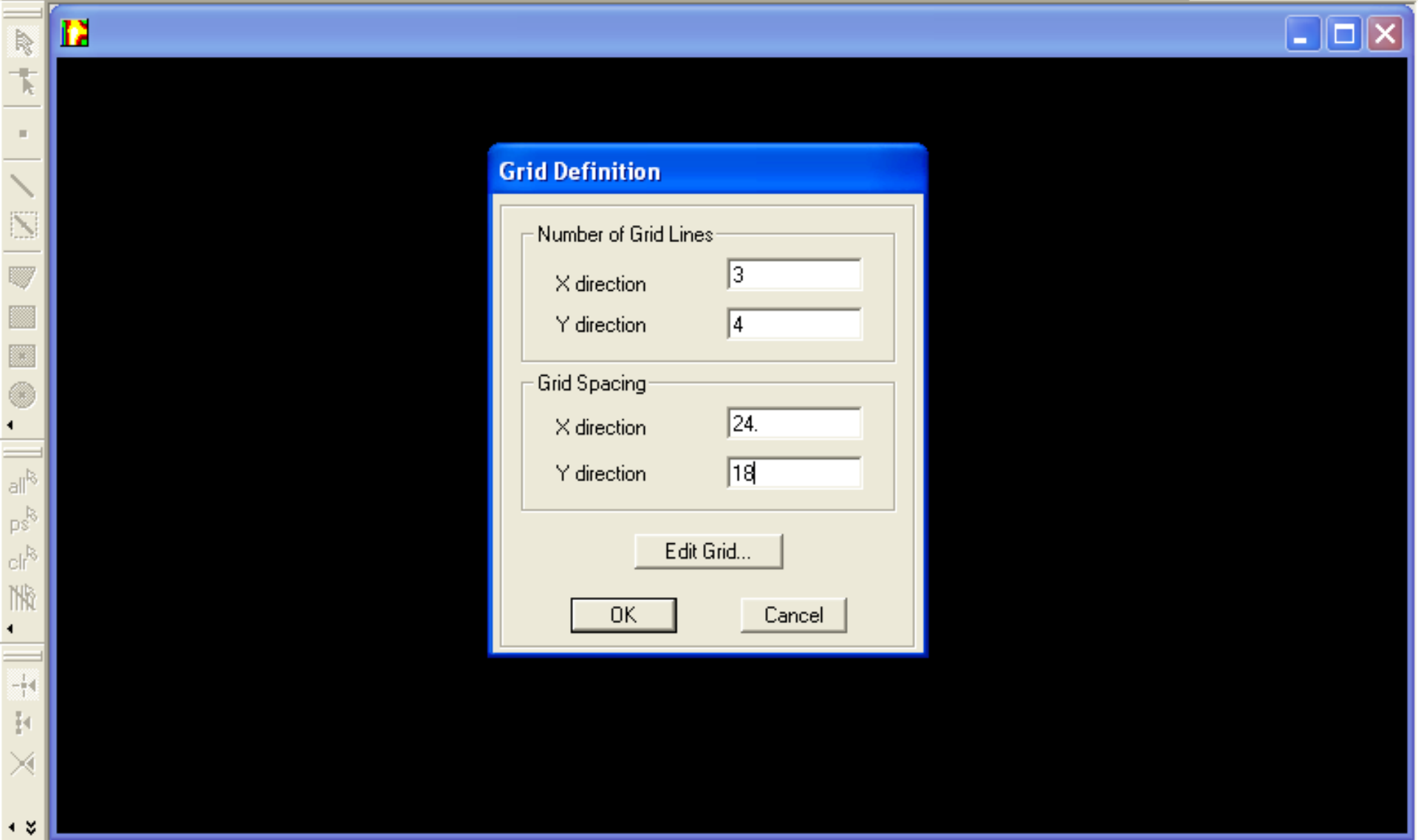

### Grid Definition

#### Number of Grid Lines

X direction

Y direction

#### Grid Spacing

X direction

Y direction

Edit Grid...

OK

Cancel

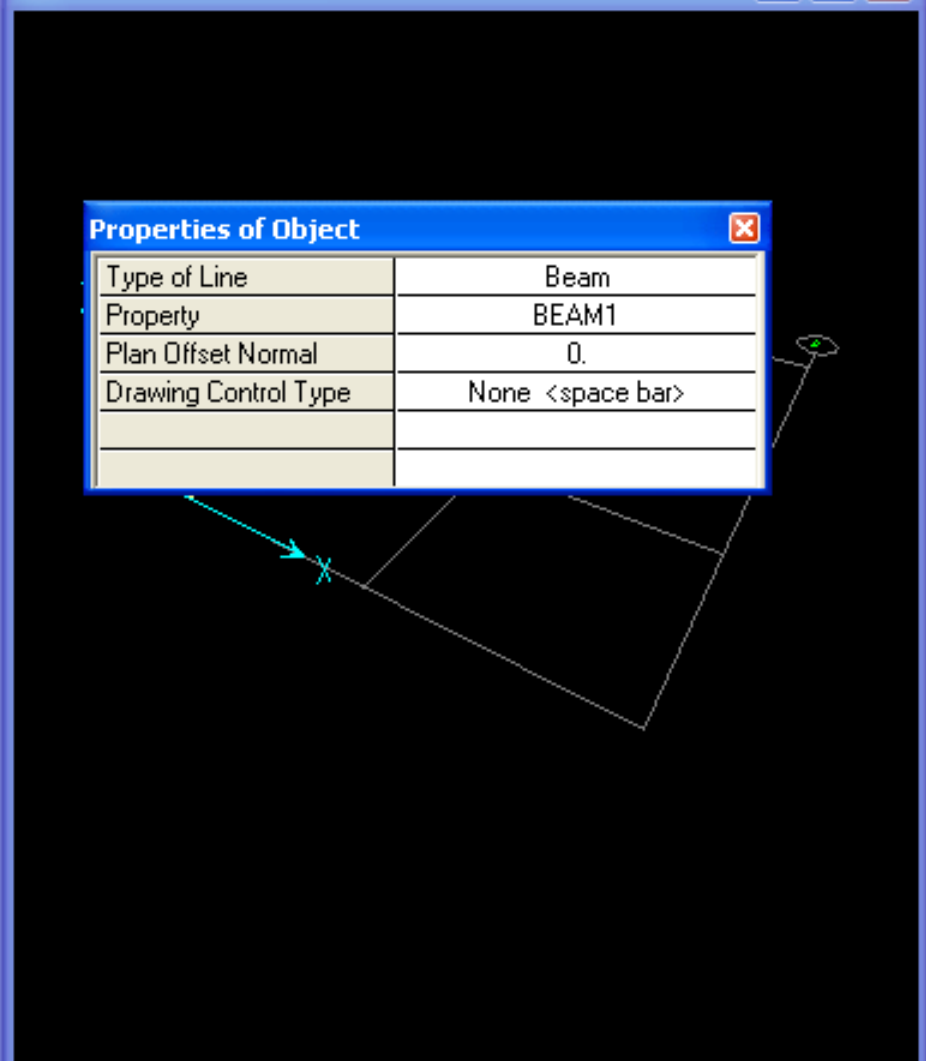
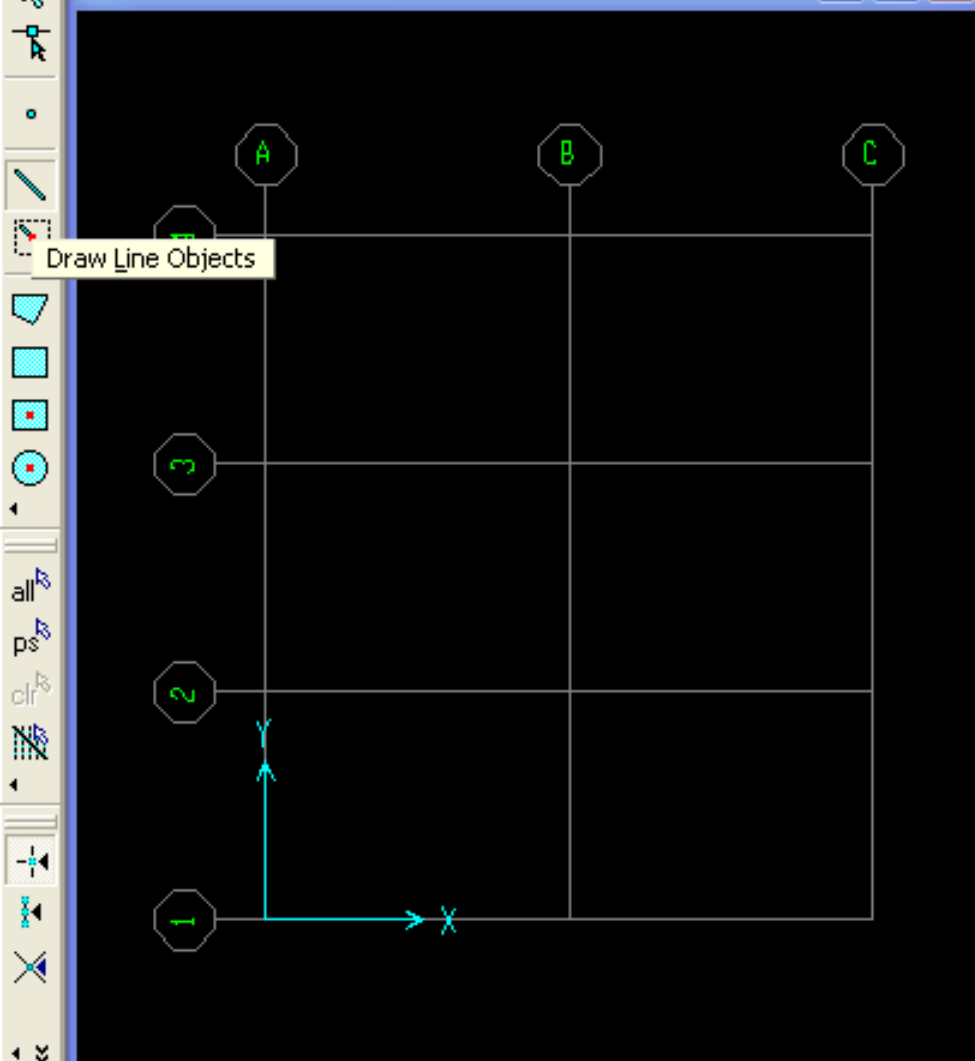

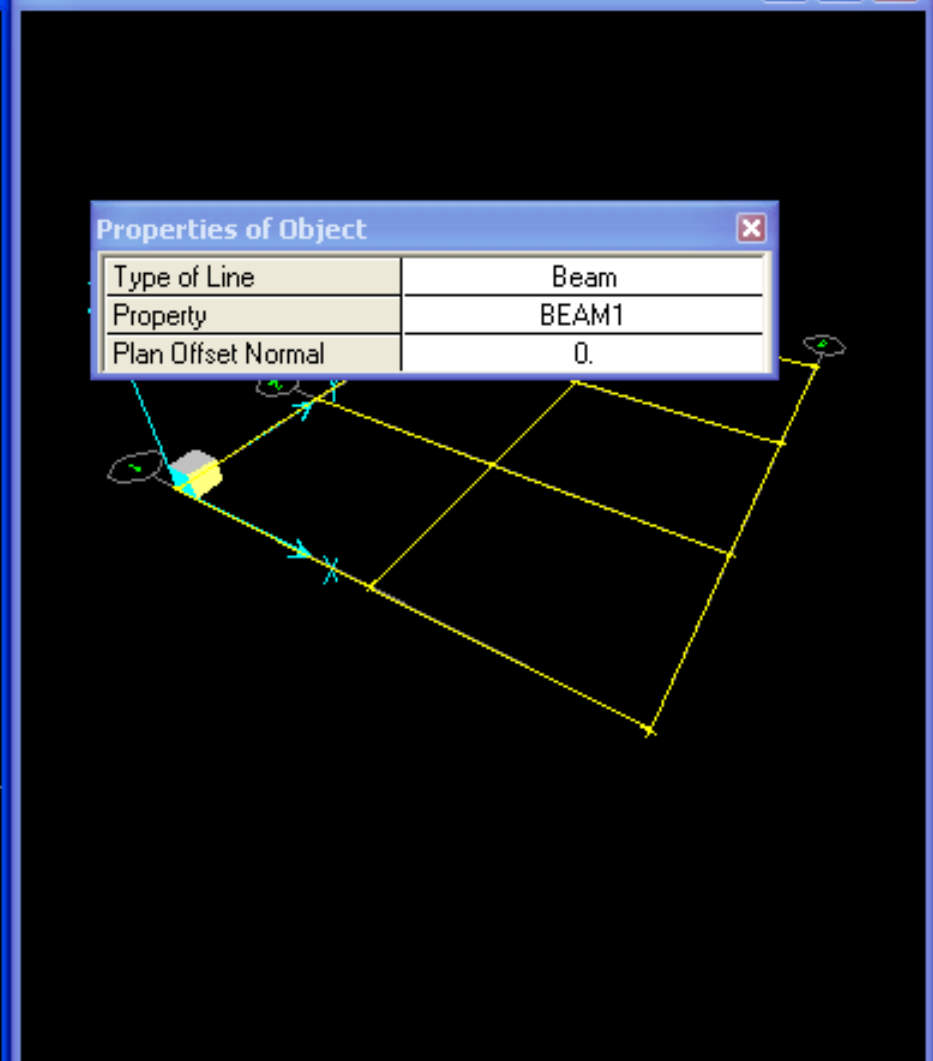
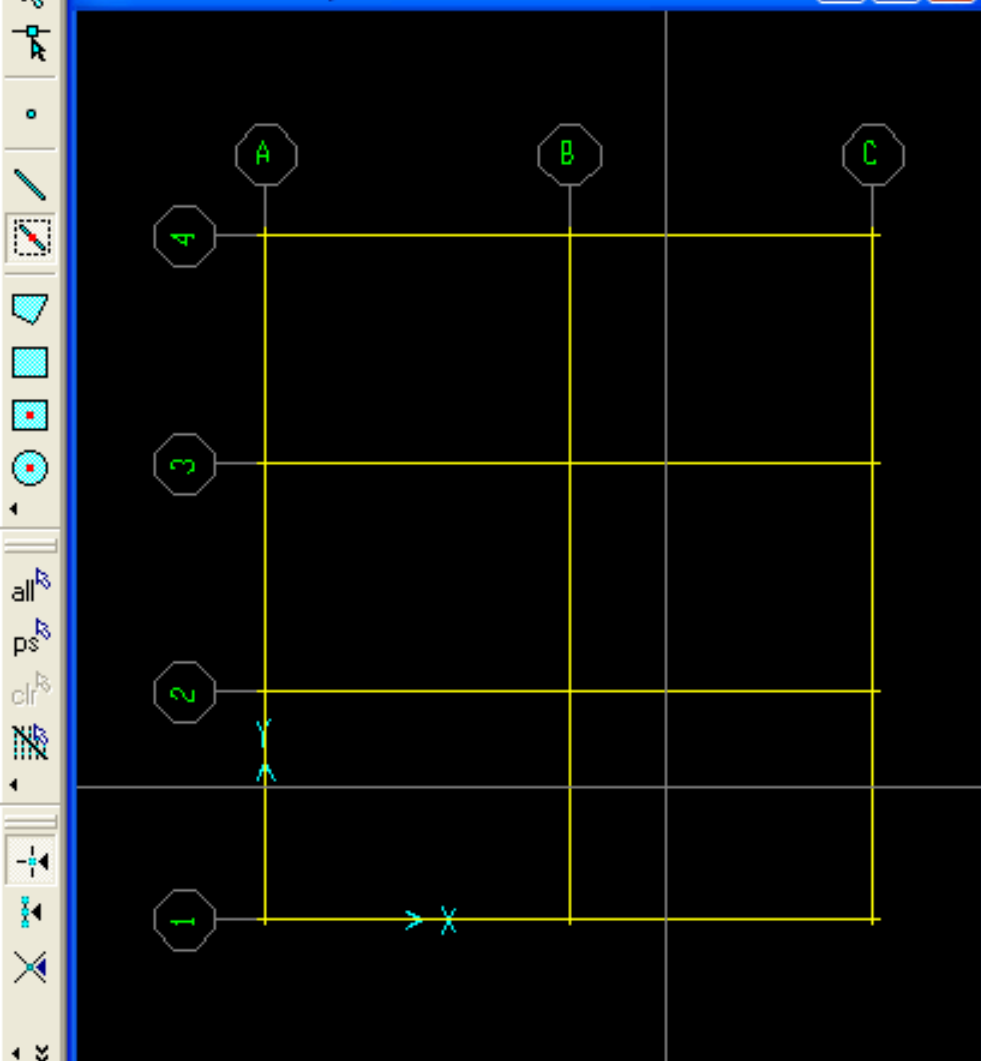

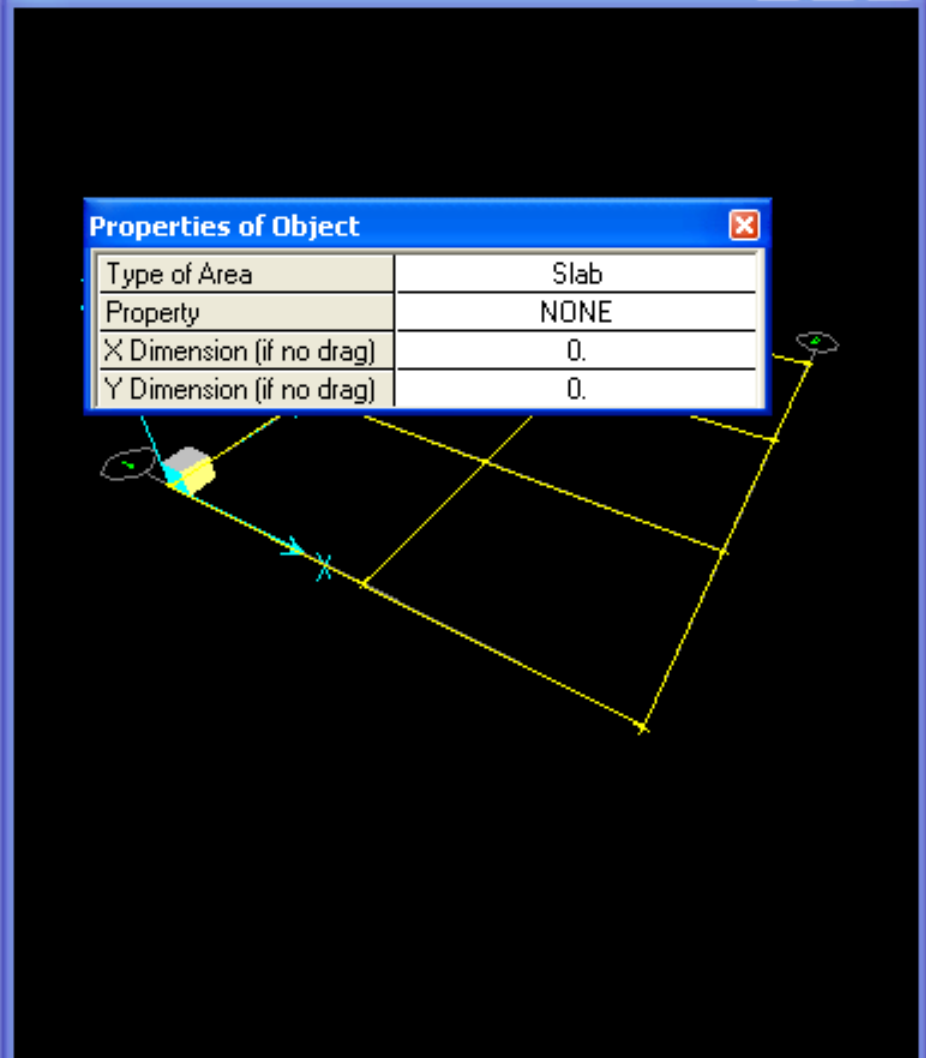
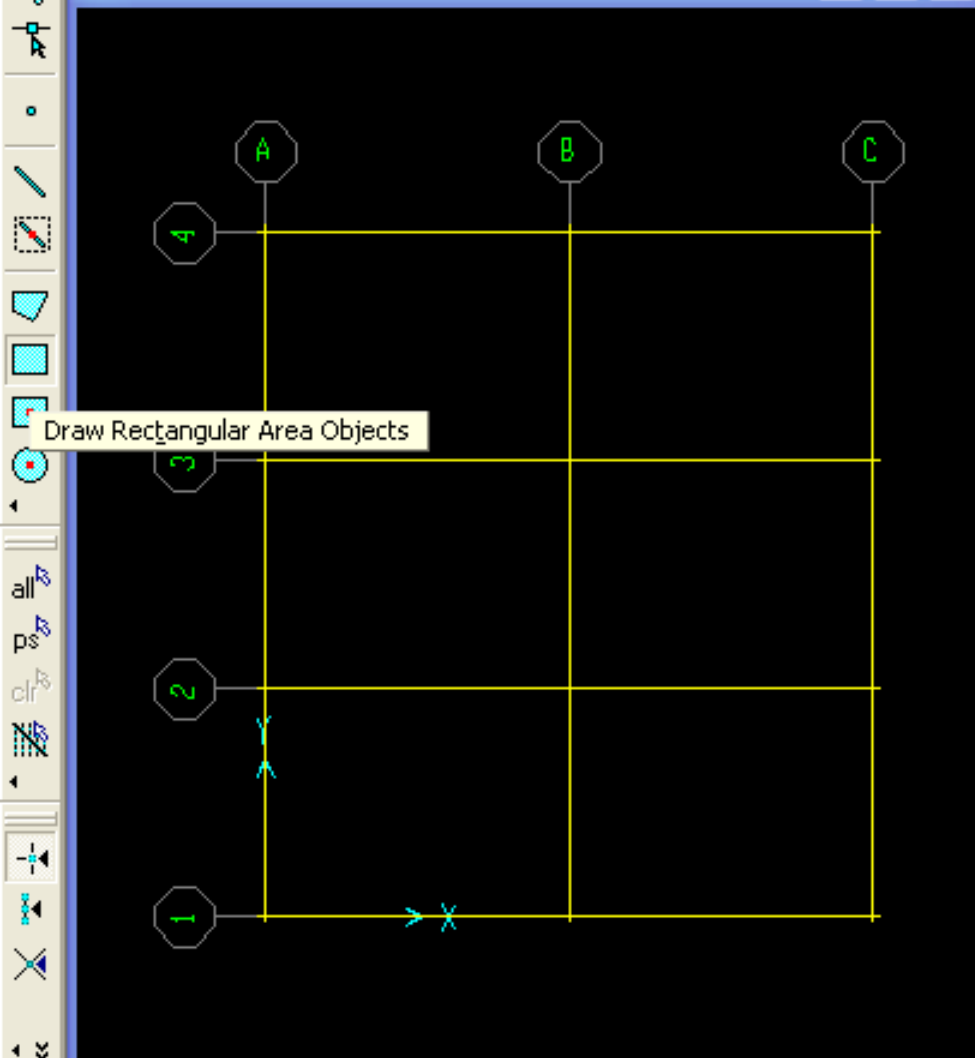

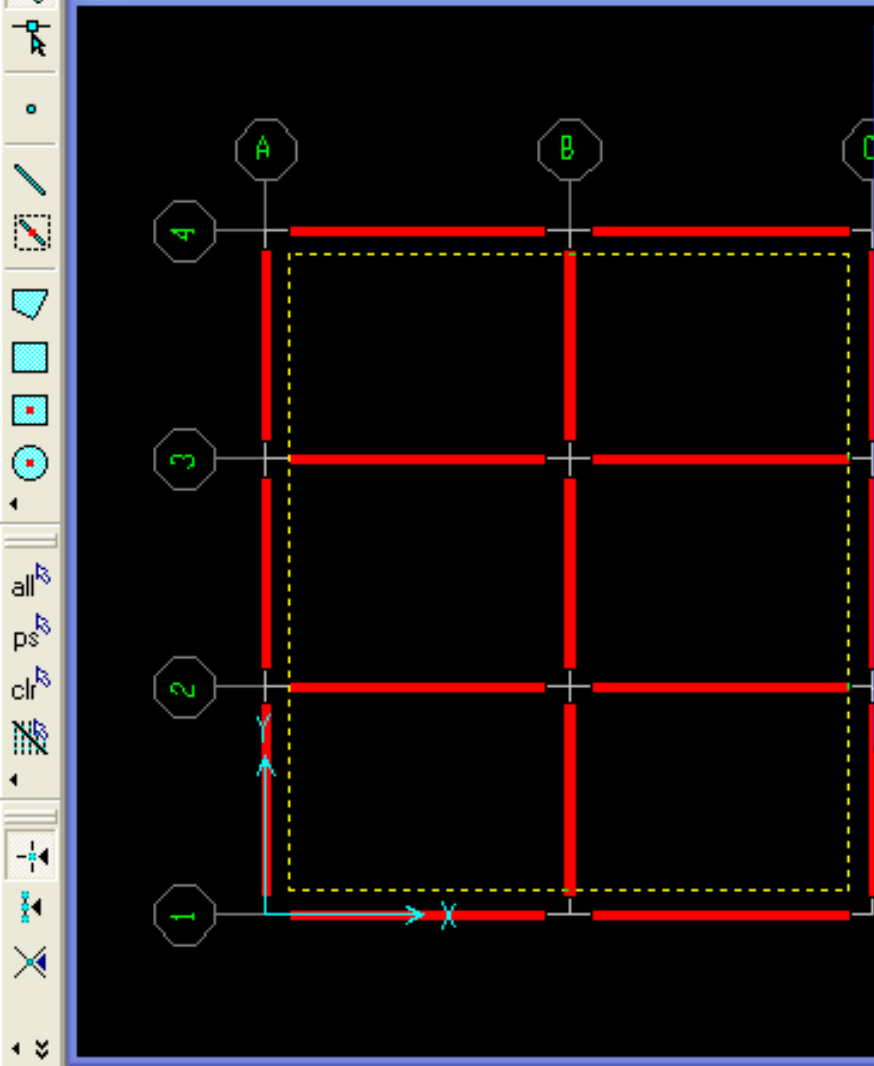

### Set Objects

Area Objects	Line Objects	Point Objects
<input type="checkbox"/> Labels	<input type="checkbox"/> Labels	<input type="checkbox"/> Labels
<input type="checkbox"/> Properties	<input type="checkbox"/> Properties	<input checked="" type="checkbox"/> Point Supports
<input checked="" type="checkbox"/> Area Supports	<input checked="" type="checkbox"/> Line Supports	<input type="checkbox"/> Hide
<input type="checkbox"/> Fill Elements	<input type="checkbox"/> Hide X-Objects	
<input checked="" type="checkbox"/> Show Edges	<input type="checkbox"/> Hide Y-Objects	
<input type="checkbox"/> Hide		

Options

<input type="checkbox"/> Shrink Elements	<input checked="" type="checkbox"/> Show Extrusions
<input type="checkbox"/> Show Mesh	<input type="checkbox"/> Show Releases
<input type="checkbox"/> Show Internal Ribs	

OK Cancel



- Slab Properties...
- Beam Properties...
- Column Supports...
- Wall Supports...
- Soil Supports...
- Static Load Cases...
- Load Combinations...
- Groups...

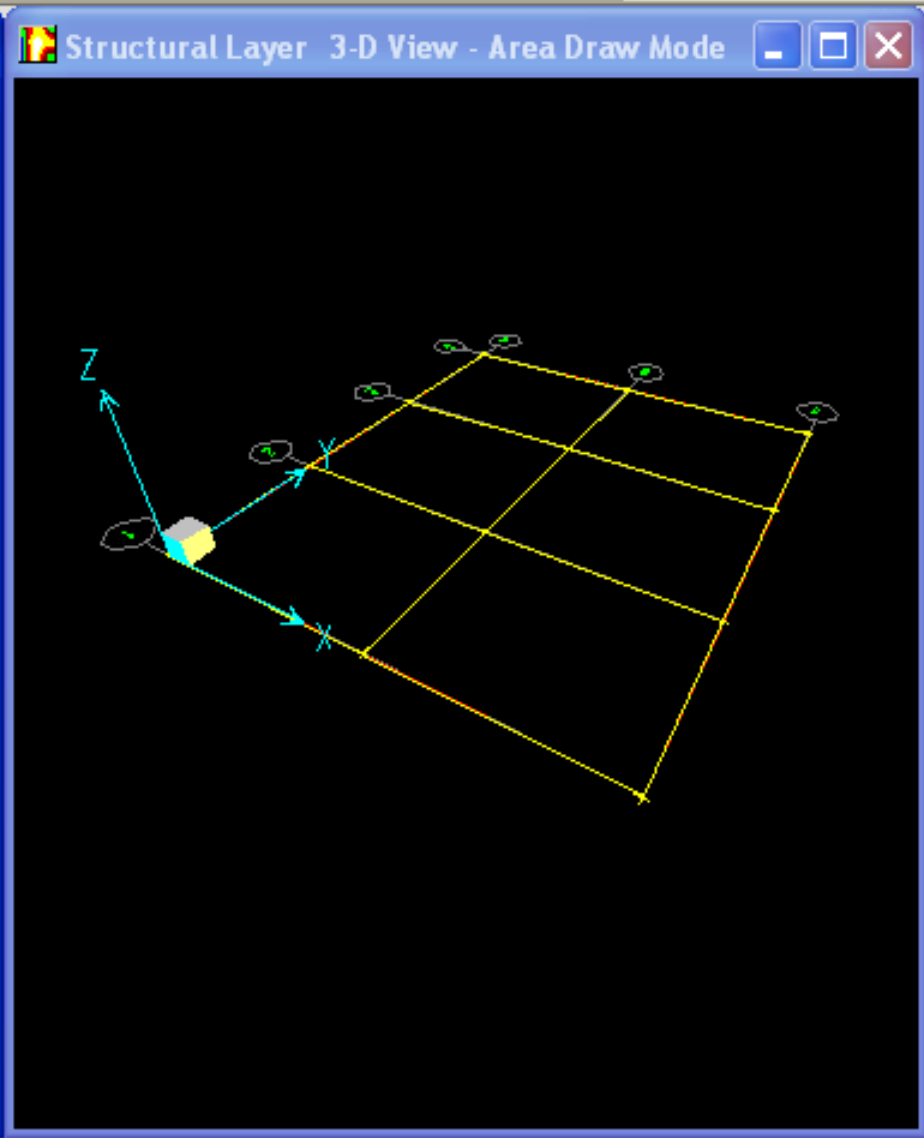
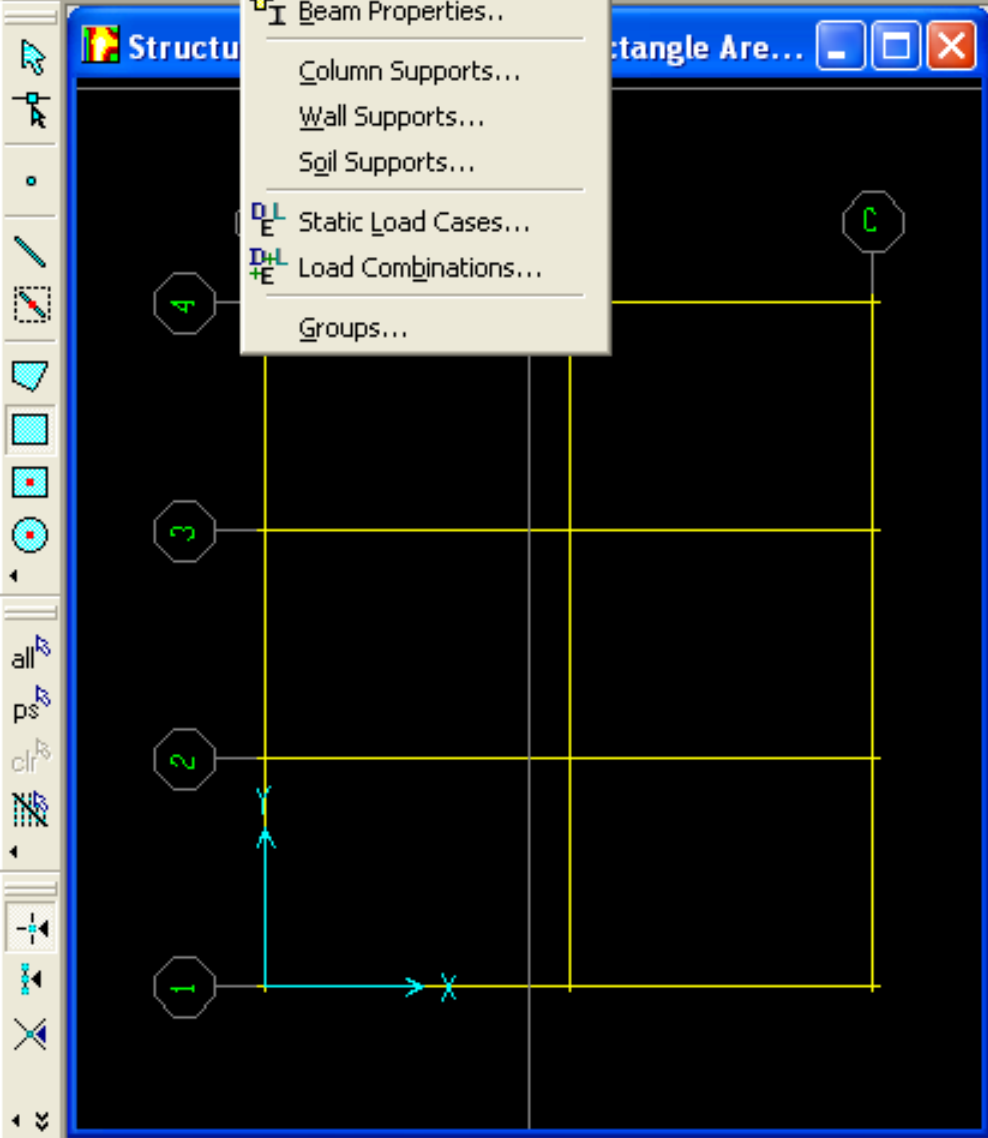
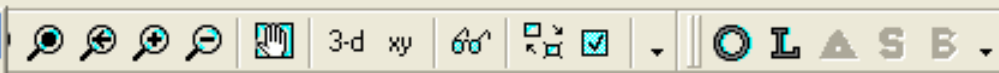

Click on first corner of rectangle

20.800 , 70.969

Kip-ft



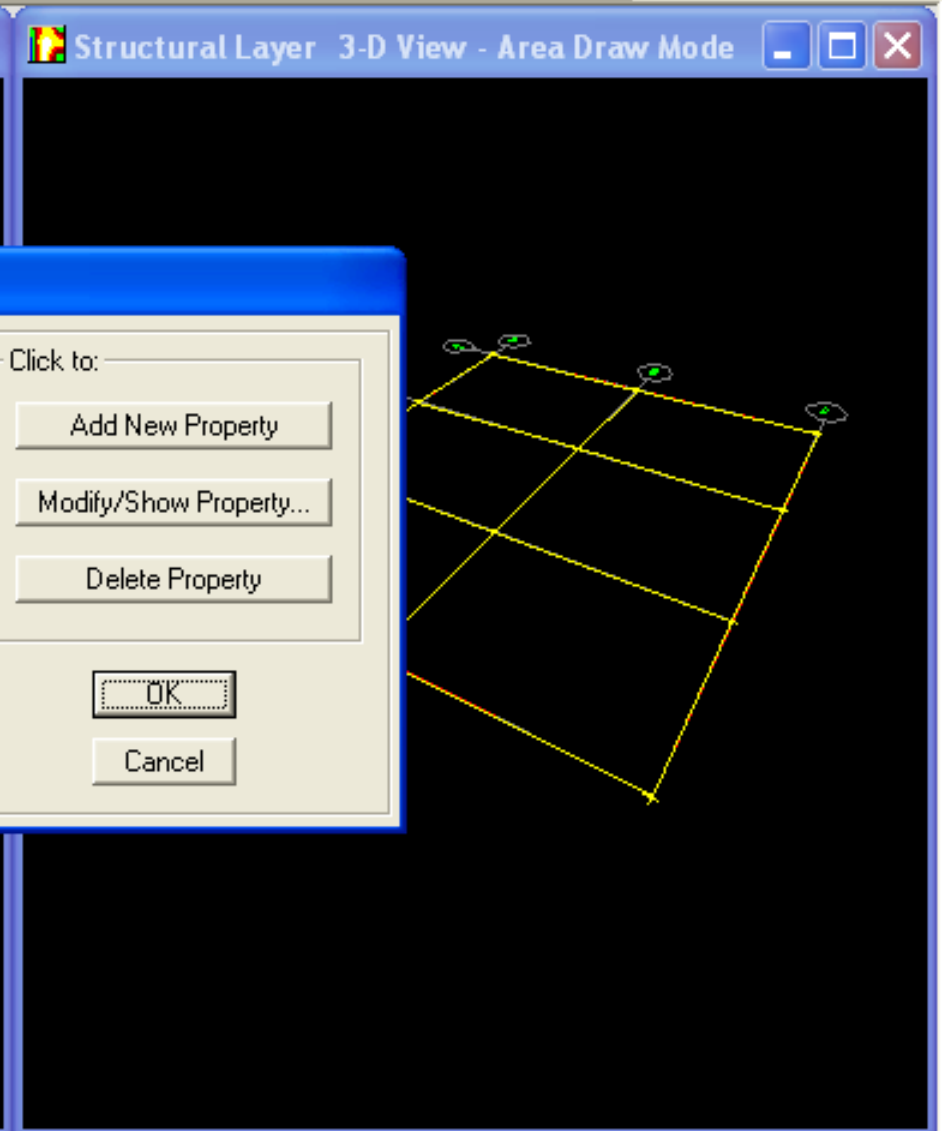
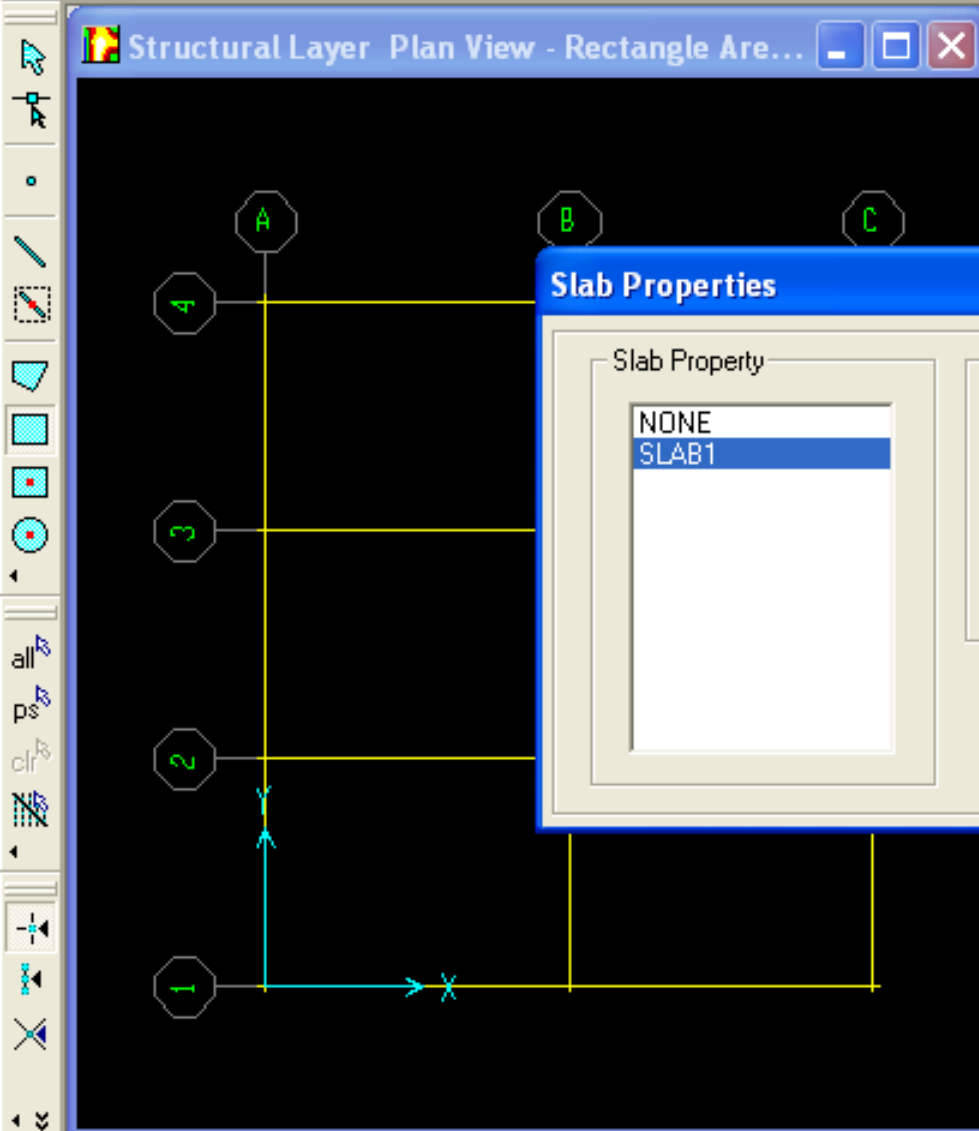

### Slab Properties

Slab Property

- NONE
- SLAB1**

Click to:

- Add New Property
- Modify/Show Property...
- Delete Property

OK

Cancel

**Slab Property Data**

Property Name: SLAB6"

Analysis Property Data		Design Property Data	
Modulus of elasticity	3122	X Cover Top (to Centroid)	1
Poisson's ratio	0.2	Y Cover Top (to Centroid)	1.
Unit Weight	8.681E-05	X Cover Bottom (to Centroid)	1.
Type	Slab	Y Cover Bottom (to Centroid)	1
Thickness	6	Concrete Strength, $f_c$	3
		Reinforcing Yield stress, $f_y$	60.
		<input type="checkbox"/> No Design	
		<input type="checkbox"/> Lightweight	

Thick Plate     Orthotropic

OK    Cancel

Area Draw Mode

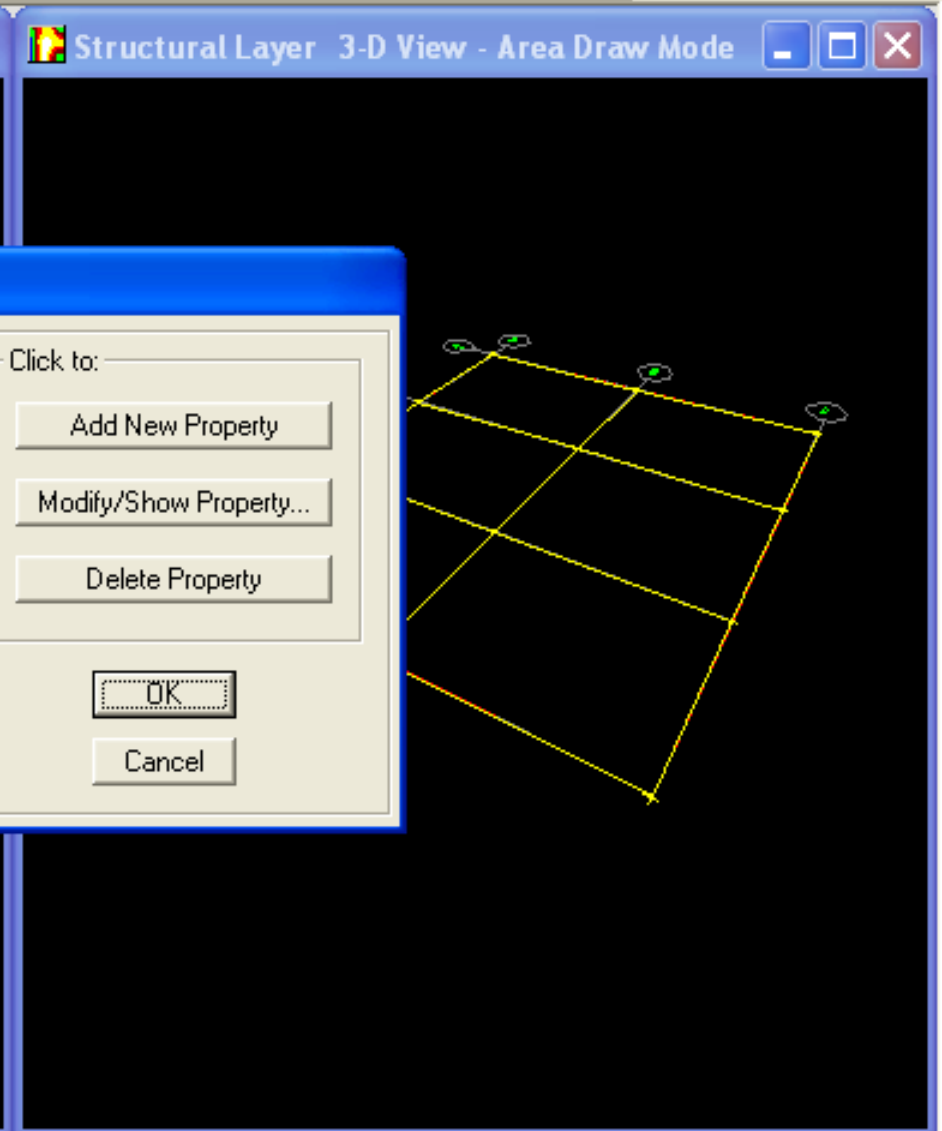
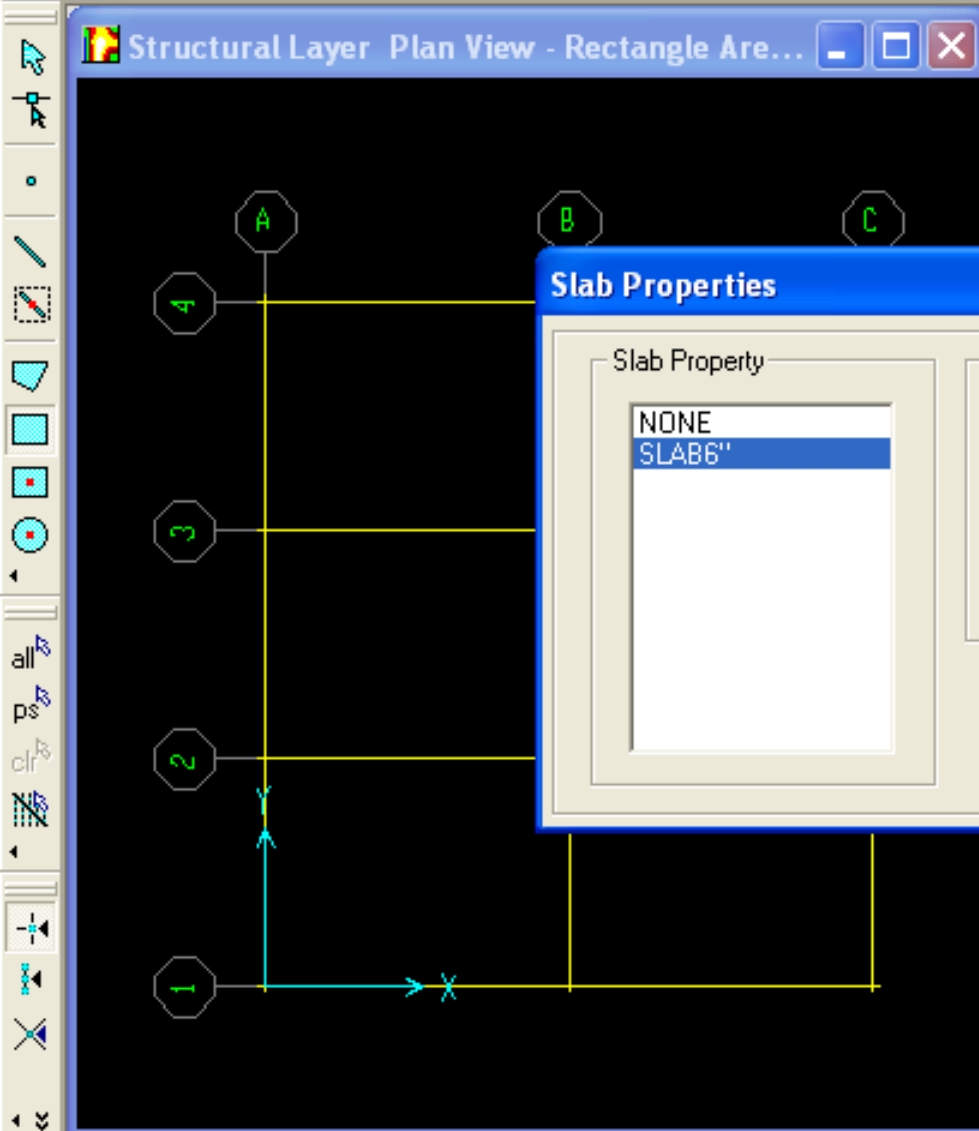

### Slab Properties

Slab Property

- NONE
- SLAB6"**

Click to:

Add New Property

Modify/Show Property...

Delete Property

OK

Cancel



**Structural La** **Slab Property Data** **Draw Mode** - □ ×

**Property Name** COL 1

**Analysis Property Data**

Modulus of elasticity	3122
Poisson's ratio	0.2
Unit Weight	8.681E-05
Type	Slab
Thickness	

Thick Plate  Orthotropic

**Design Property Data**

X Cover Top (to Centroid)	
Y Cover Top (to Centroid)	
X Cover Bottom (to Centroid)	
Y Cover Bottom (to Centroid)	
Concrete Strength, $f_c$	
Reinforcing Yield stress, $f_y$	
<input checked="" type="checkbox"/> No Design	
<input type="checkbox"/> Lightweight	

OK Cancel

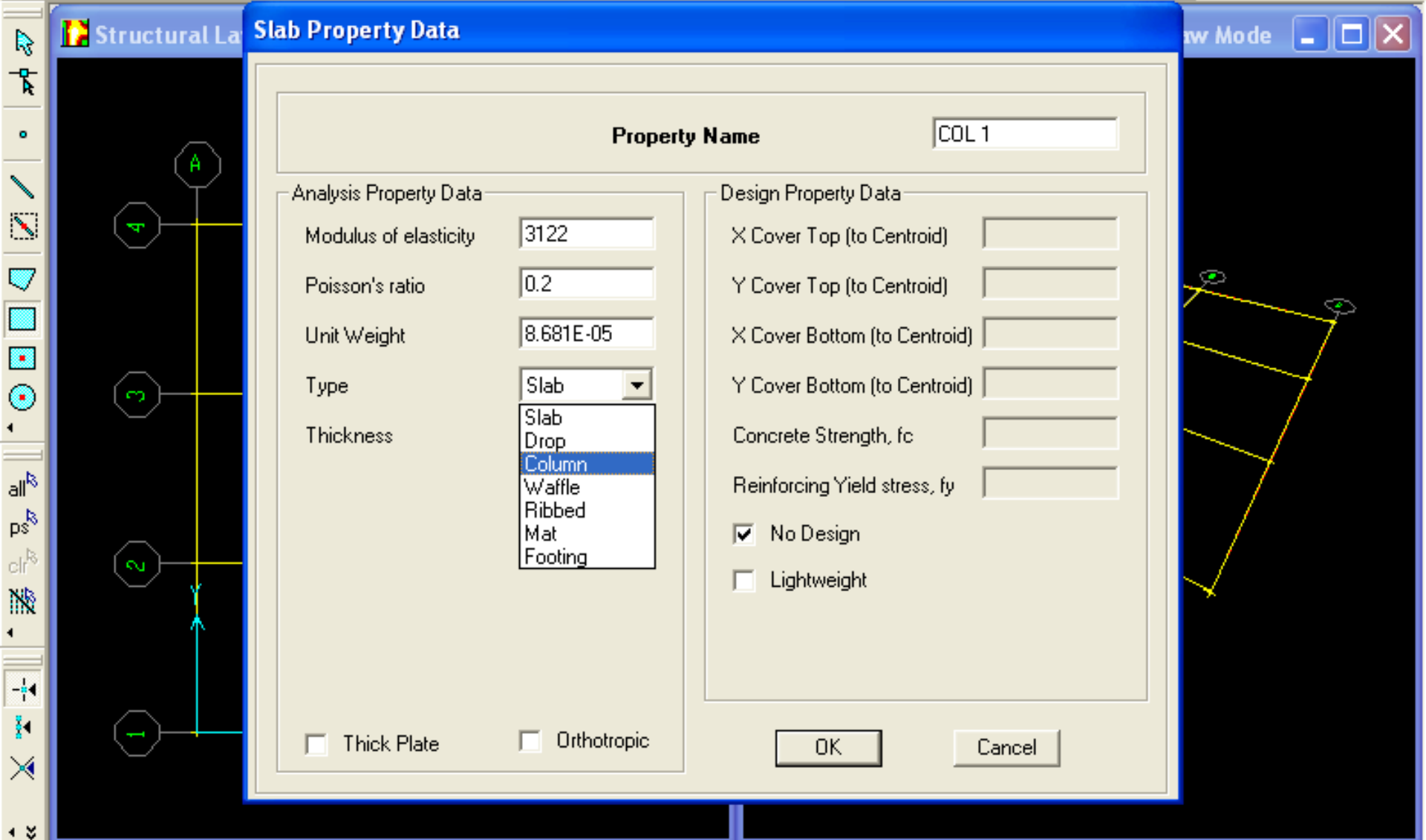

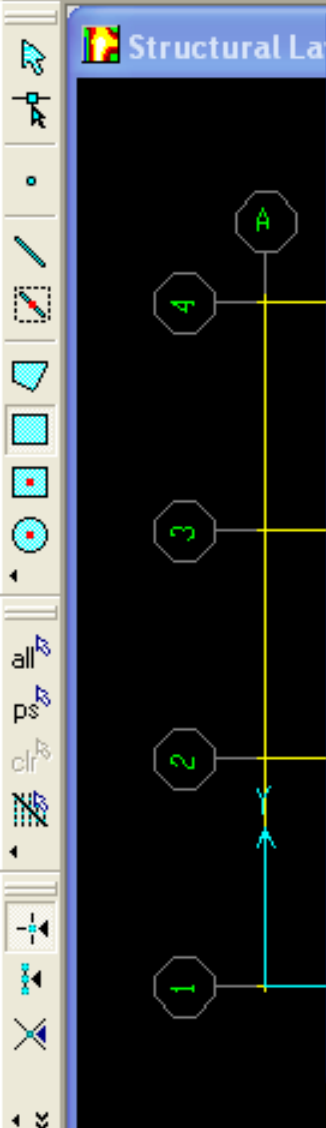
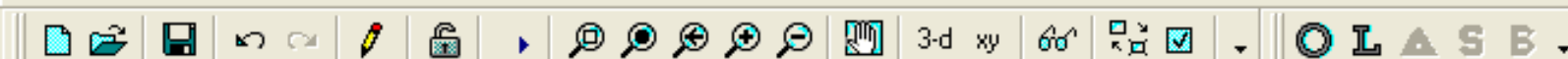

### Slab Property Data

Property Name: COL 1

Analysis Property Data		Design Property Data	
Modulus of elasticity	3122	X Cover Top (to Centroid)	
Poisson's ratio	0.2	Y Cover Top (to Centroid)	
Unit Weight	8.681E-05	X Cover Bottom (to Centroid)	
Type	Column	Y Cover Bottom (to Centroid)	
Thickness	120	Concrete Strength, $f_c$	
		Reinforcing Yield stress, $f_y$	
		<input checked="" type="checkbox"/> No Design	
		<input type="checkbox"/> Lightweight	

Thick Plate     Orthotropic

OK    Cancel

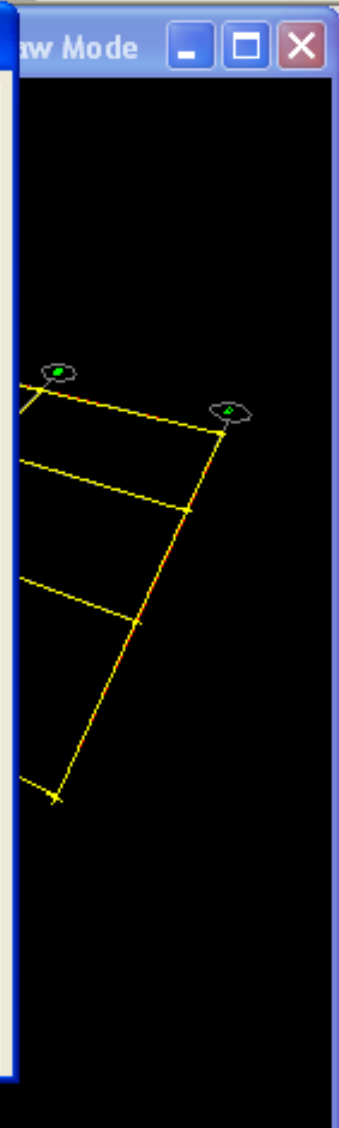

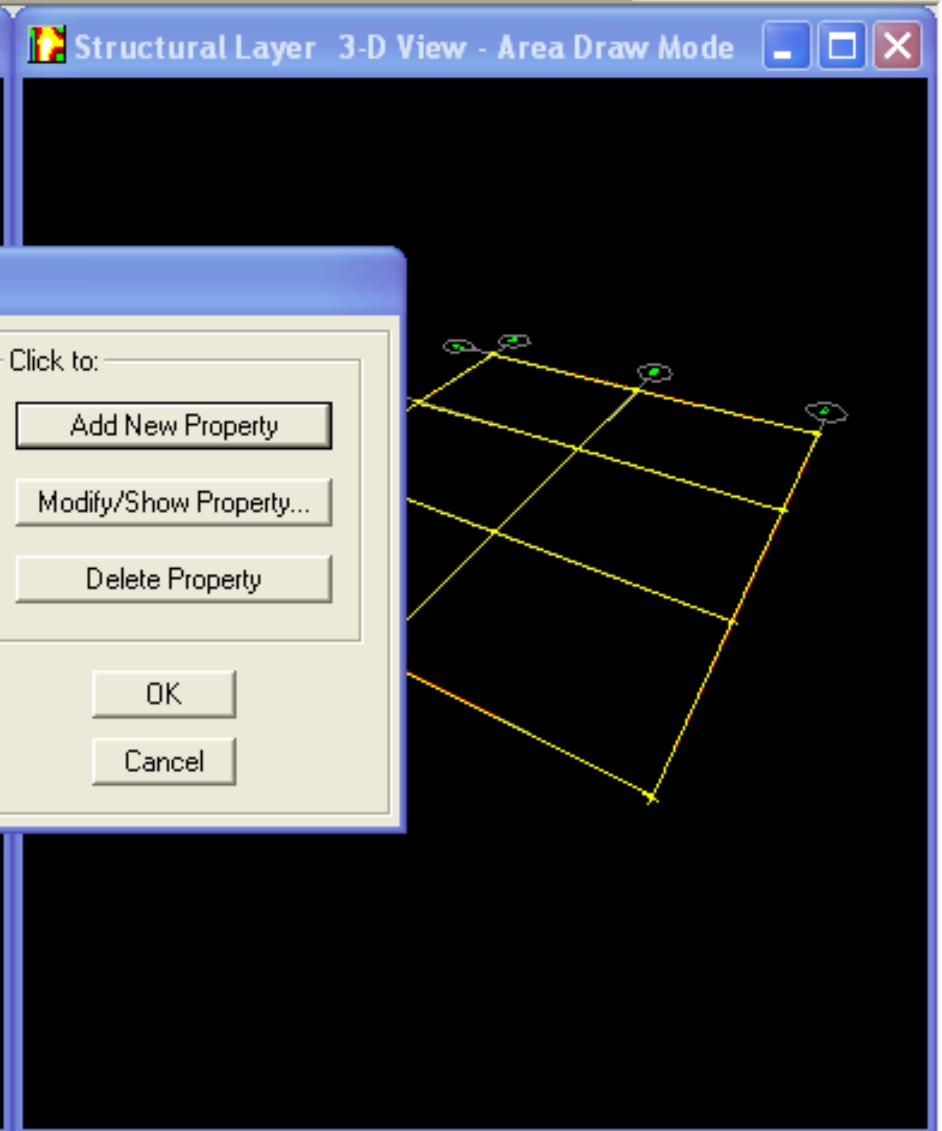
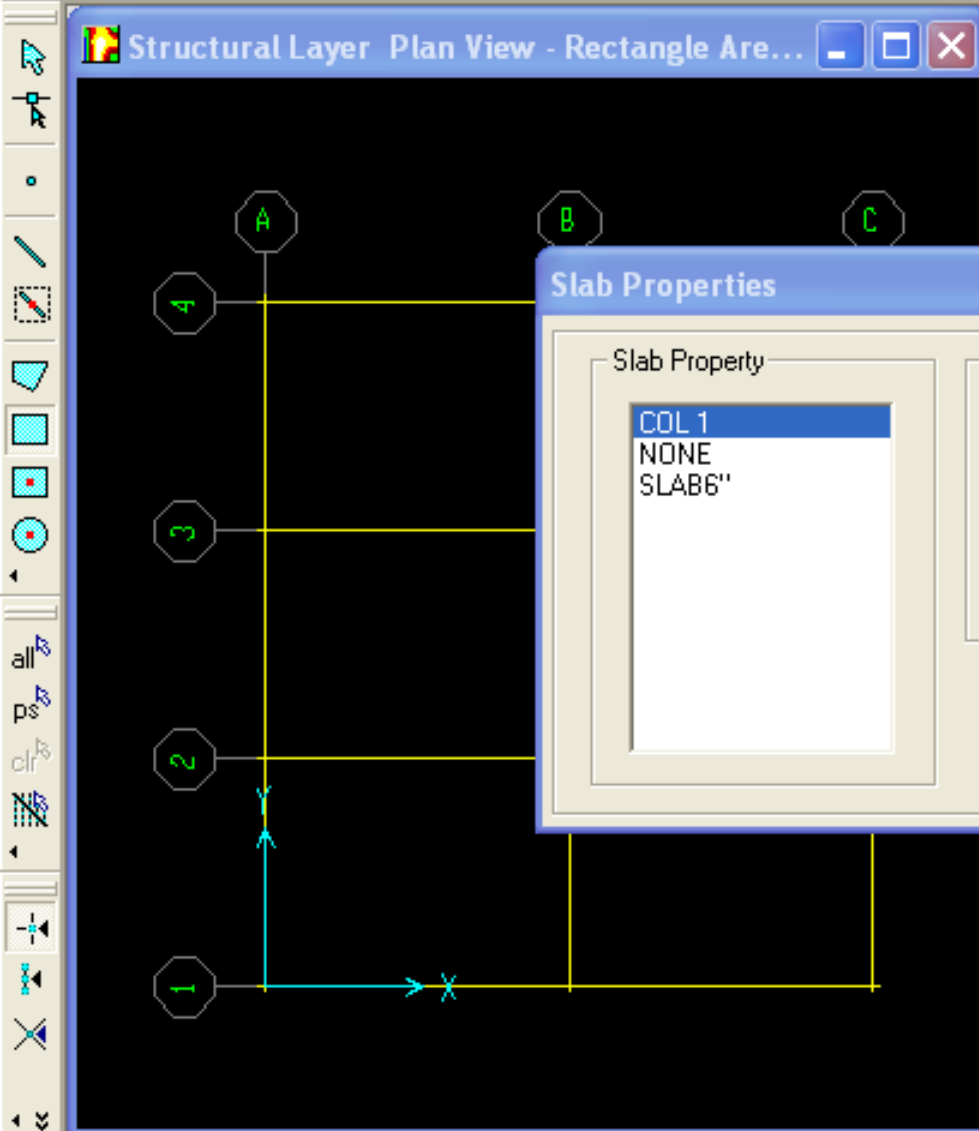

### Slab Properties

Slab Property

- COL 1
- NONE
- SLAB6"

Click to:

Add New Property

Modify/Show Property...

Delete Property

OK

Cancel

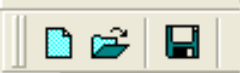

- Slab Properties...
- Beam Properties...
- Column Supports...
- Wall Supports...
- Soil Supports...
- Static Load Cases...
- Load Combinations...
- Groups...

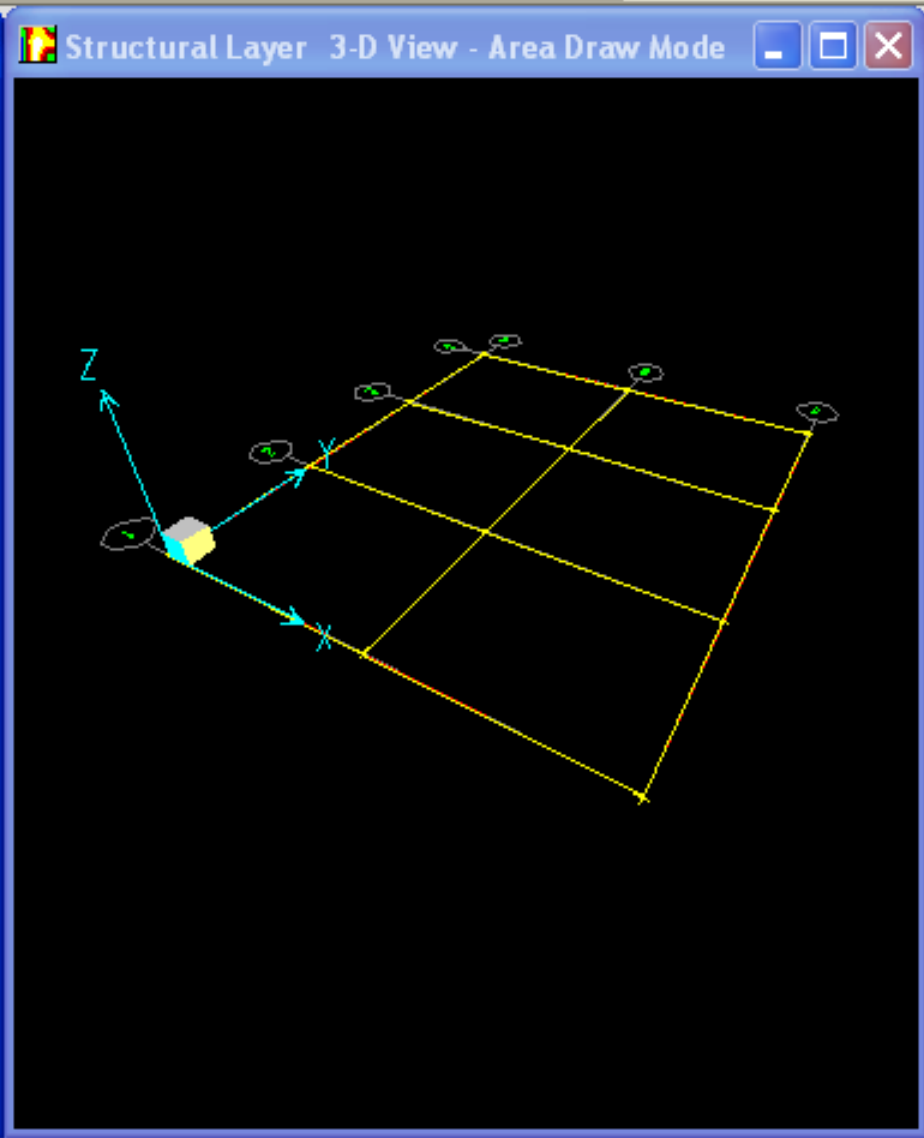
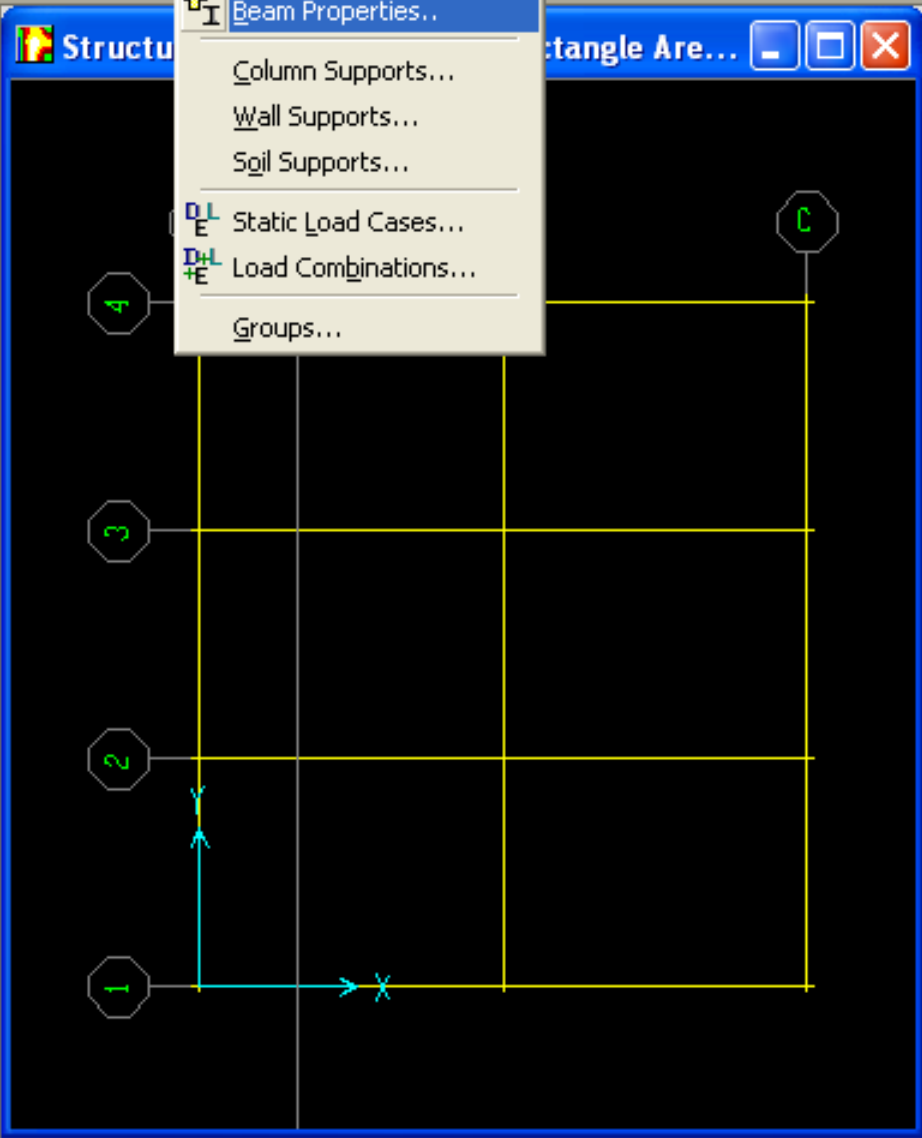
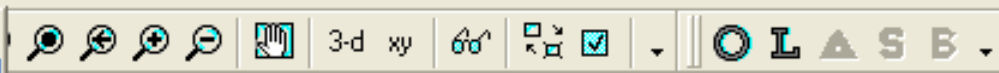

Click on first corner of rectangle

92.592 , 860.730

Kip-in

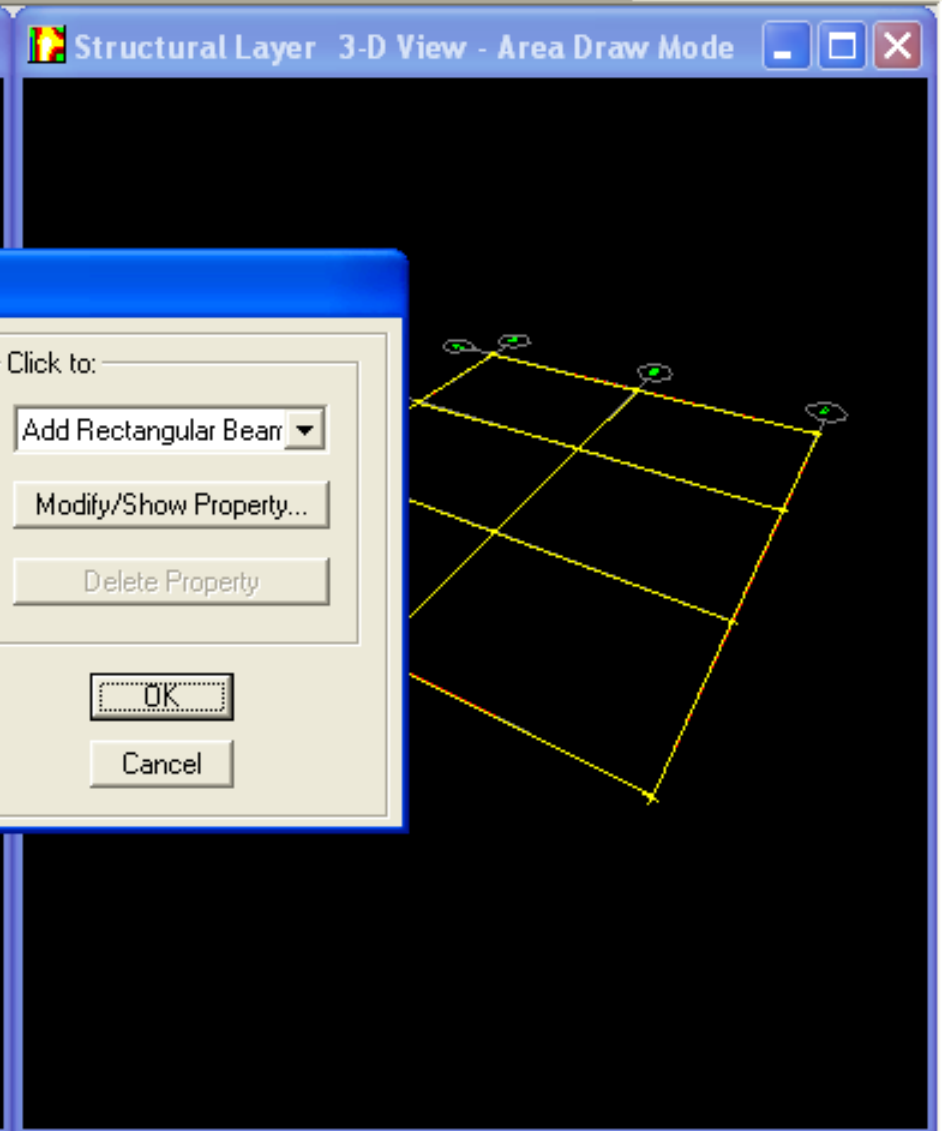
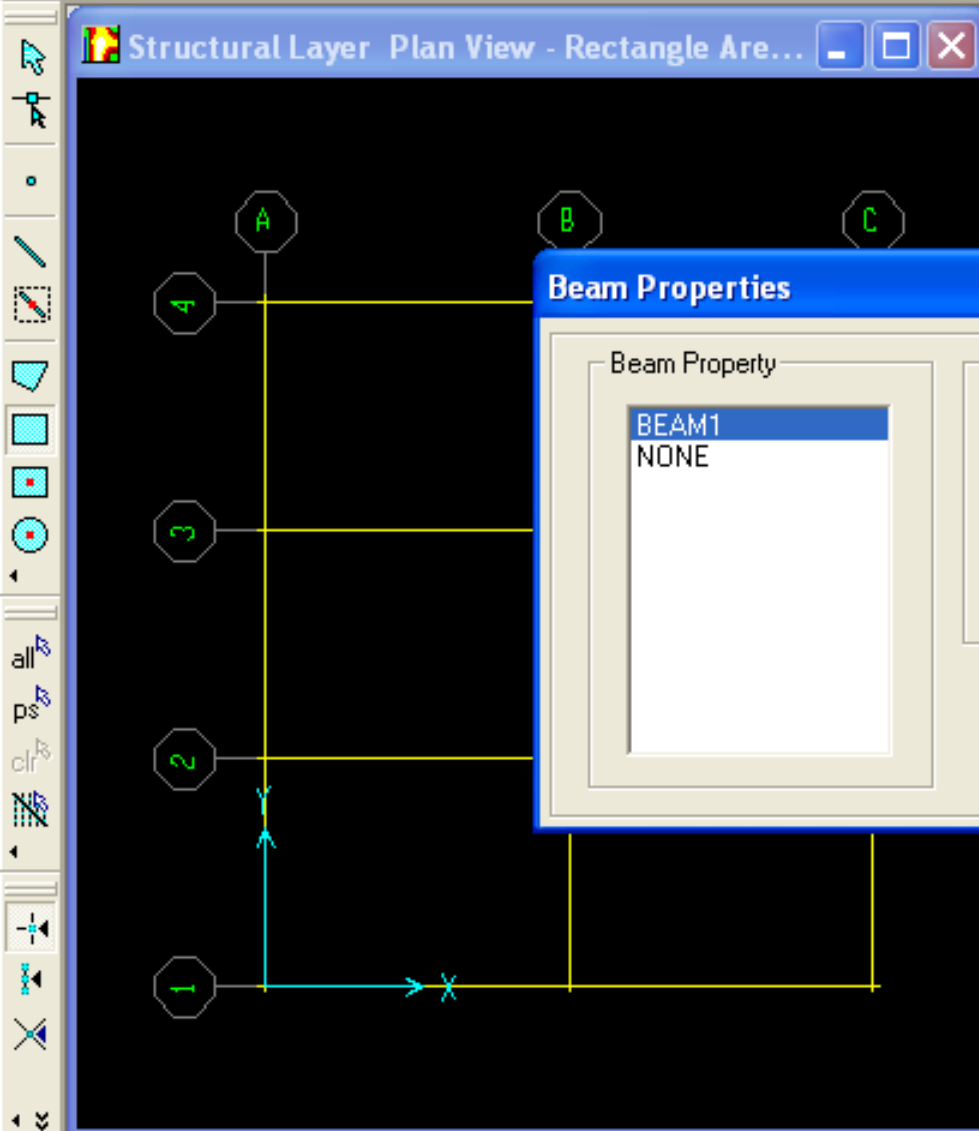

### Beam Properties

Beam Property

- BEAM1
- NONE

Click to:

- Add Rectangular Beam
- Modify/Show Property...
- Delete Property

OK

Cancel



### Property Data for Rectangular Beam

**Beam Property Name** B1

Analysis Property Data		Design Property Data	
Modulus of Elasticity	3122	Width	12.
Poisson's Ratio	0.2	Depth	24.
Unit Weight	8.681E-05	Cover Top (to Centroid)	2
Width	12.	Cover Bottom (to Centroid)	2
Depth	24.	Concrete Strength, $f_c$	3
		Reinforcing Yield Stress, $f_y$	60.
		Shear Steel Yield Stress, $f_{ys}$	40
		Concrete Shear Strength, $f_{cs}$	3
		<input type="checkbox"/> No Design	

OK Cancel

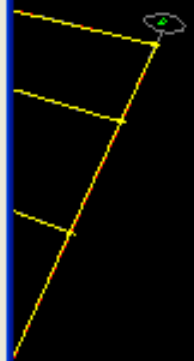
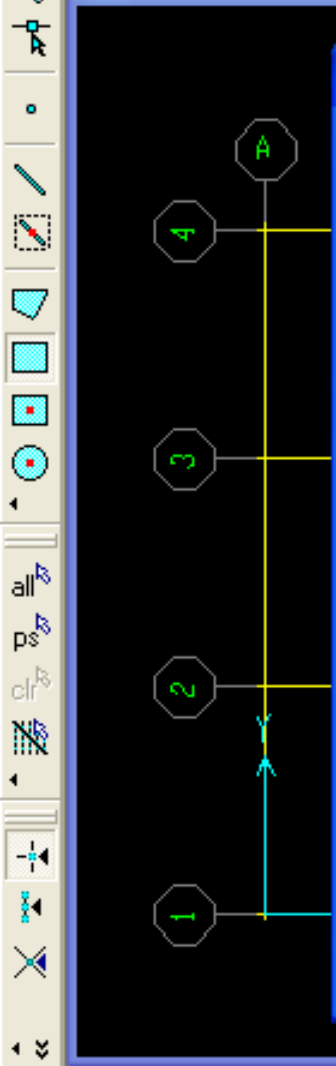

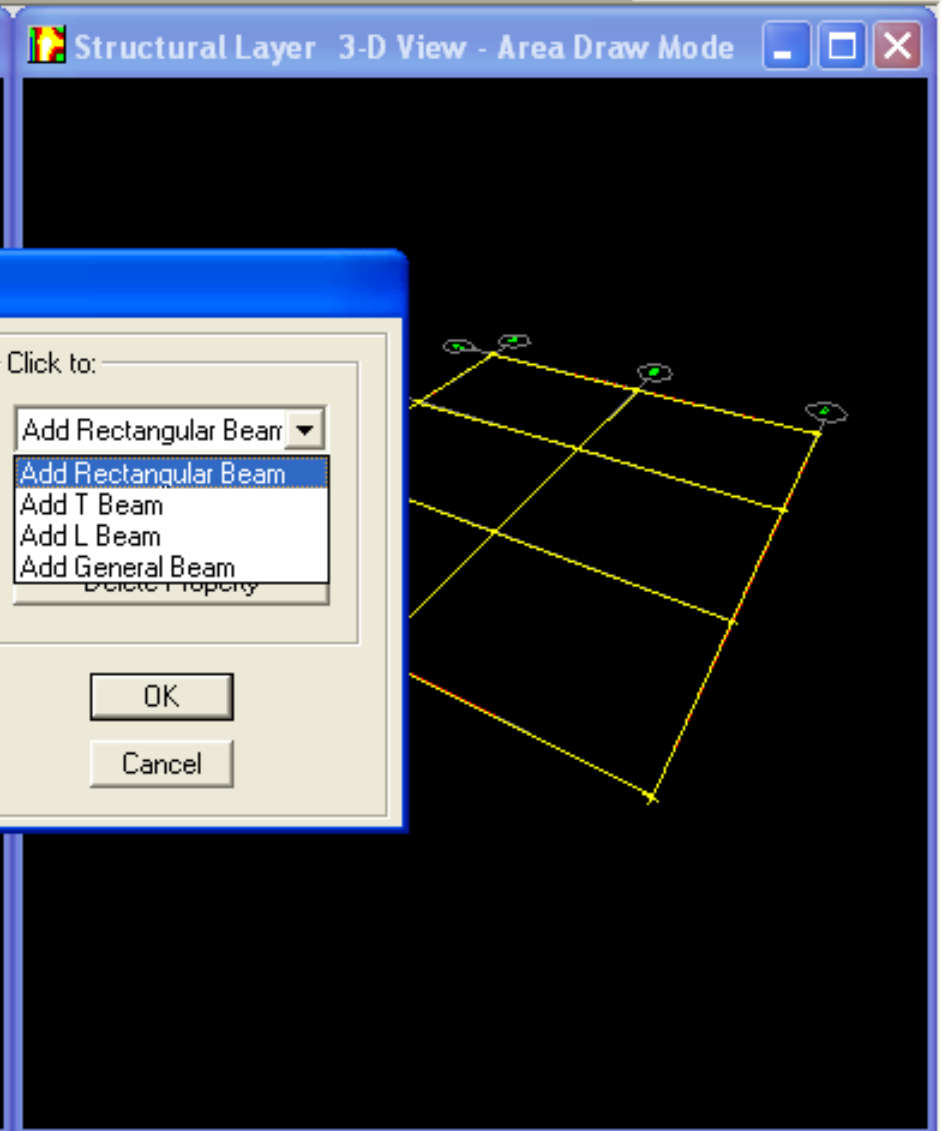
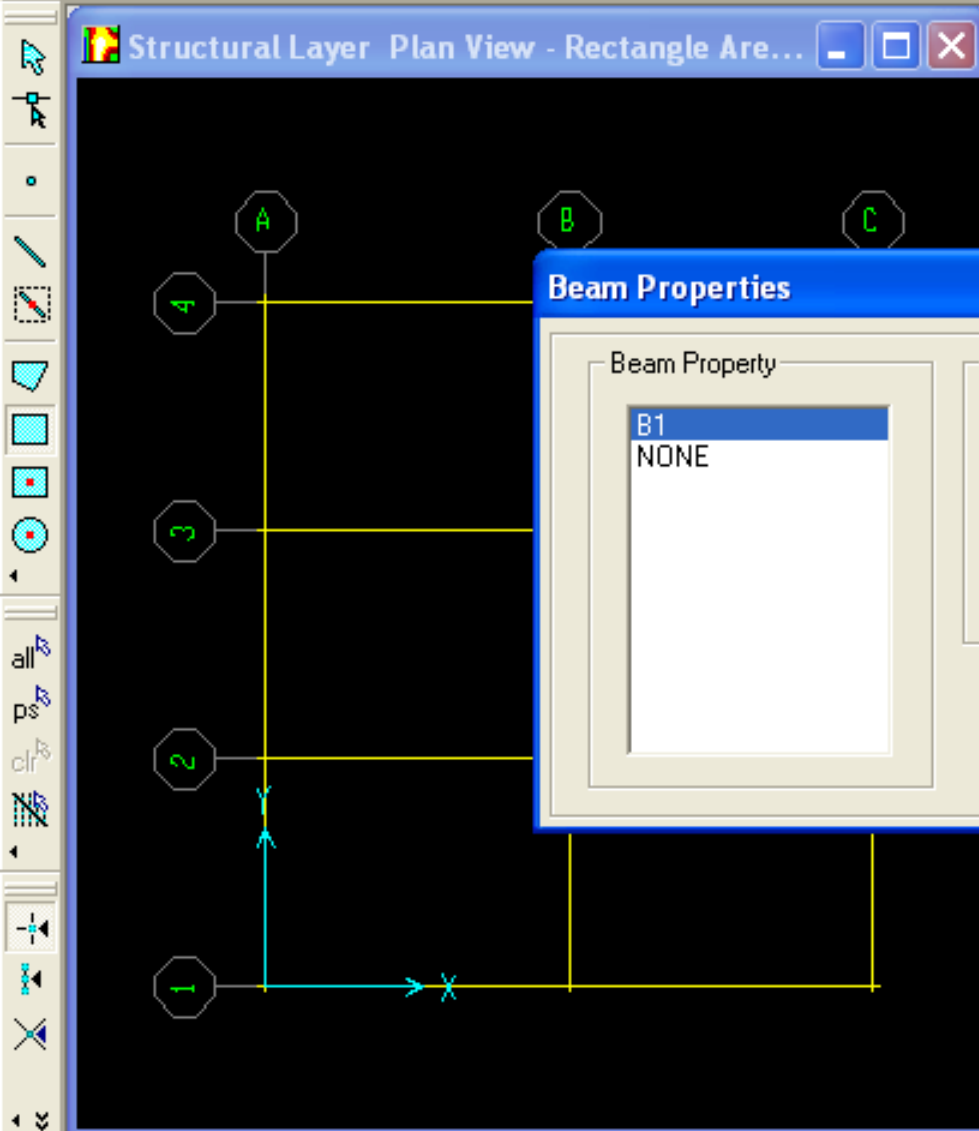

### Beam Properties

Beam Property

- B1
- NONE

Click to:

- Add Rectangular Beam
- Add Rectangular Beam
- Add T Beam
- Add L Beam
- Add General Beam
- Delete Property

OK

Cancel

### Property Data for Rectangular Beam

**Beam Property Name**

Analysis Property Data		Design Property Data	
Modulus of Elasticity	<input type="text" value="3122"/>	Width	<input type="text" value="12"/>
Poisson's Ratio	<input type="text" value="0.2"/>	Depth	<input type="text" value="18"/>
Unit Weight	<input type="text" value="8.681E-05"/>	Cover Top (to Centroid)	<input type="text" value="2"/>
Width	<input type="text" value="12"/>	Cover Bottom (to Centroid)	<input type="text" value="2"/>
Depth	<input type="text" value="18"/>	Concrete Strength, $f_c$	<input type="text" value="3"/>
		Reinforcing Yield Stress, $f_y$	<input type="text" value="60"/>
		Shear Steel Yield Stress, $f_{ys}$	<input type="text" value="40"/>
		Concrete Shear Strength, $f_{cs}$	<input type="text" value="3"/>
		<input type="checkbox"/> No Design	

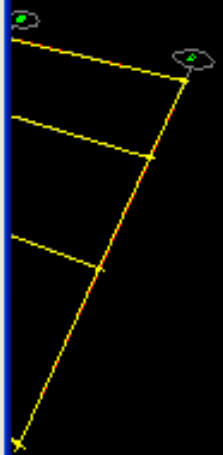
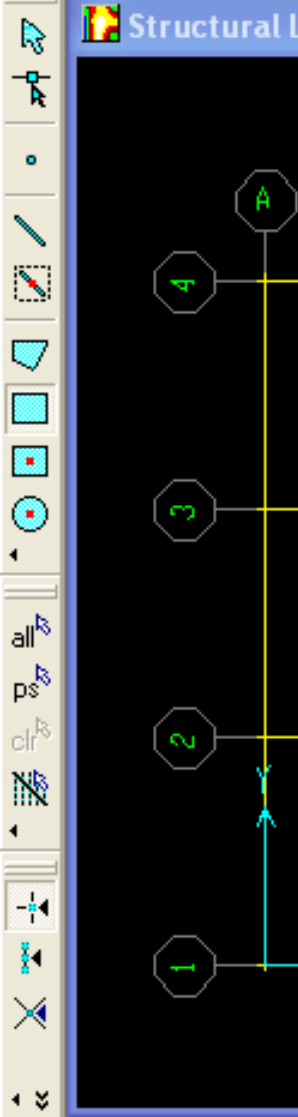

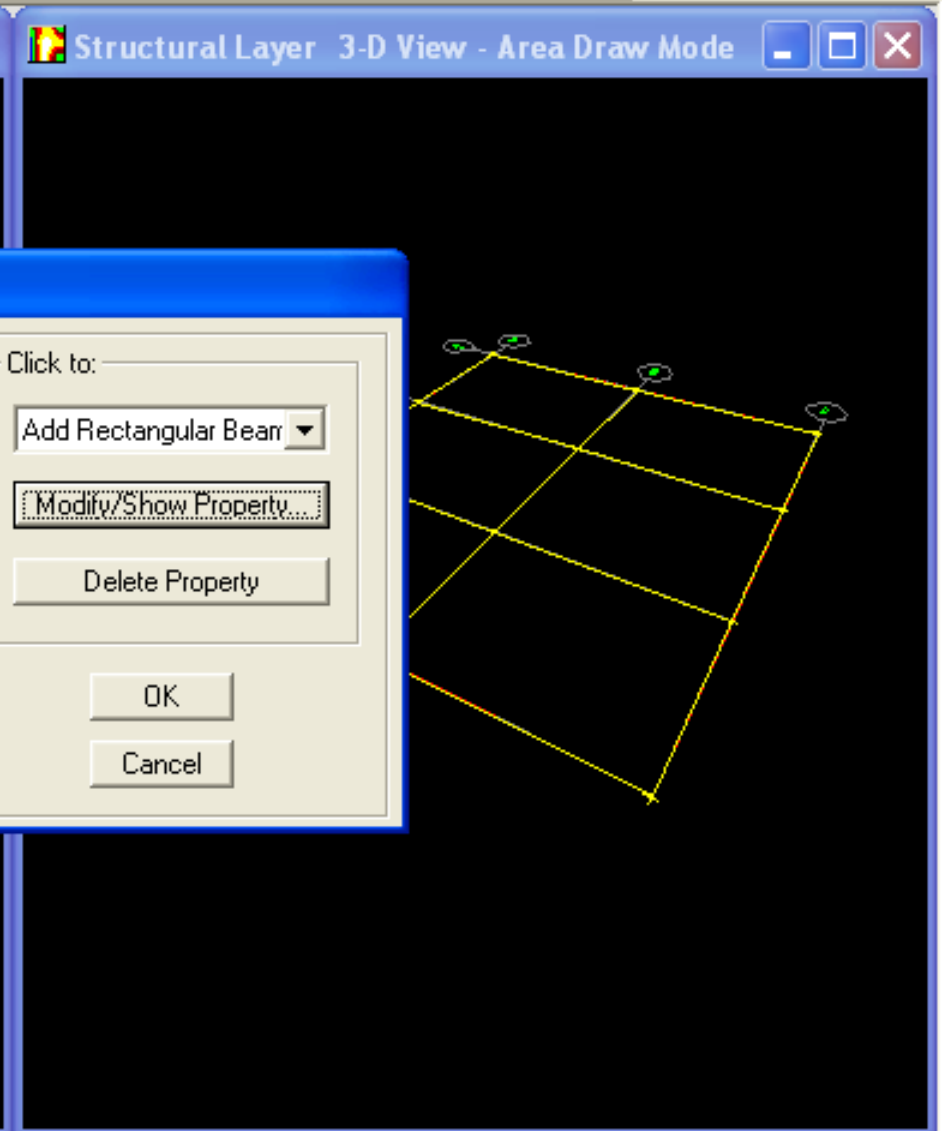
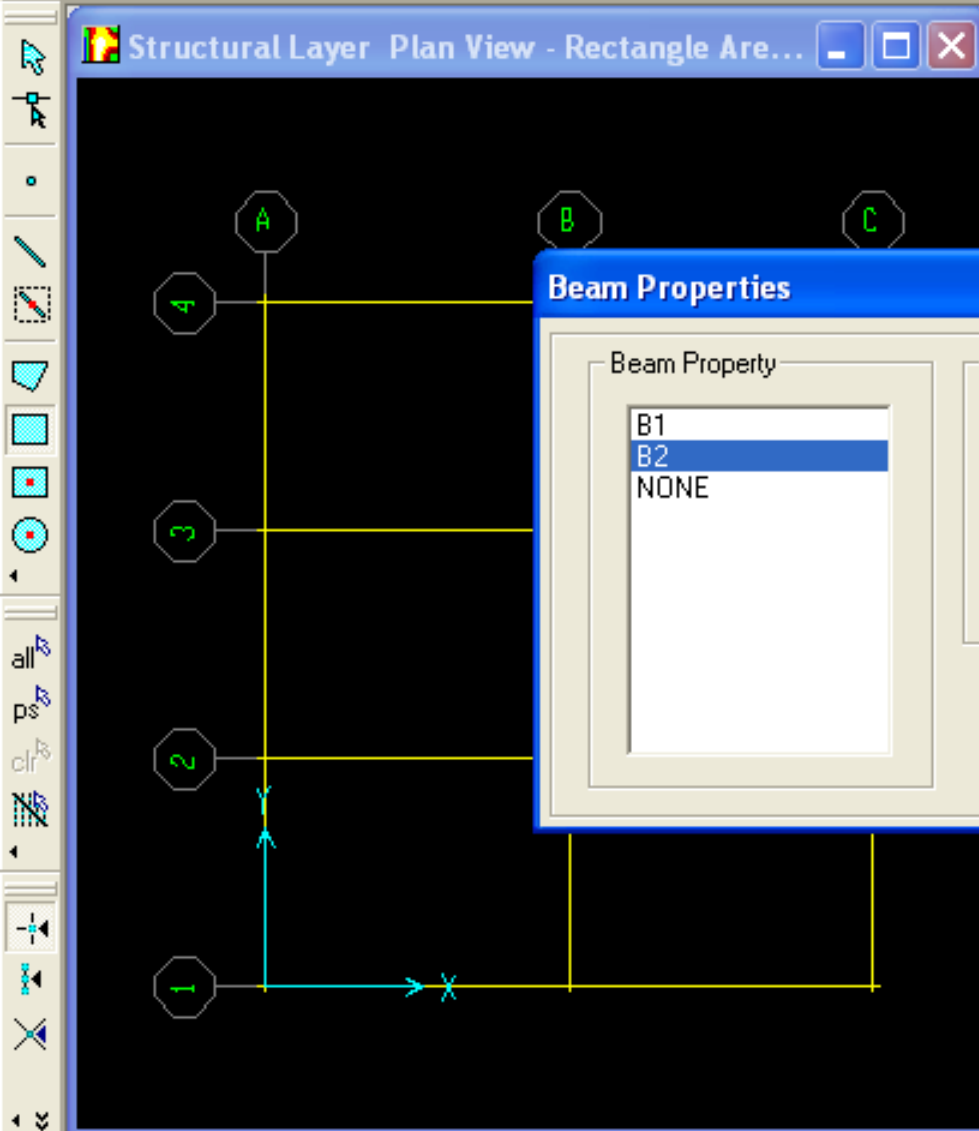

### Beam Properties

Beam Property

- B1
- B2**
- NONE

Click to:

Add Rectangular Beam

Modify/Show Property

Delete Property

OK

Cancel



- Slab Properties...
- Beam Properties...
- Column Supports...**
- Wall Supports...
- Soil Supports...
- Static Load Cases...
- Load Combinations...
- Groups...

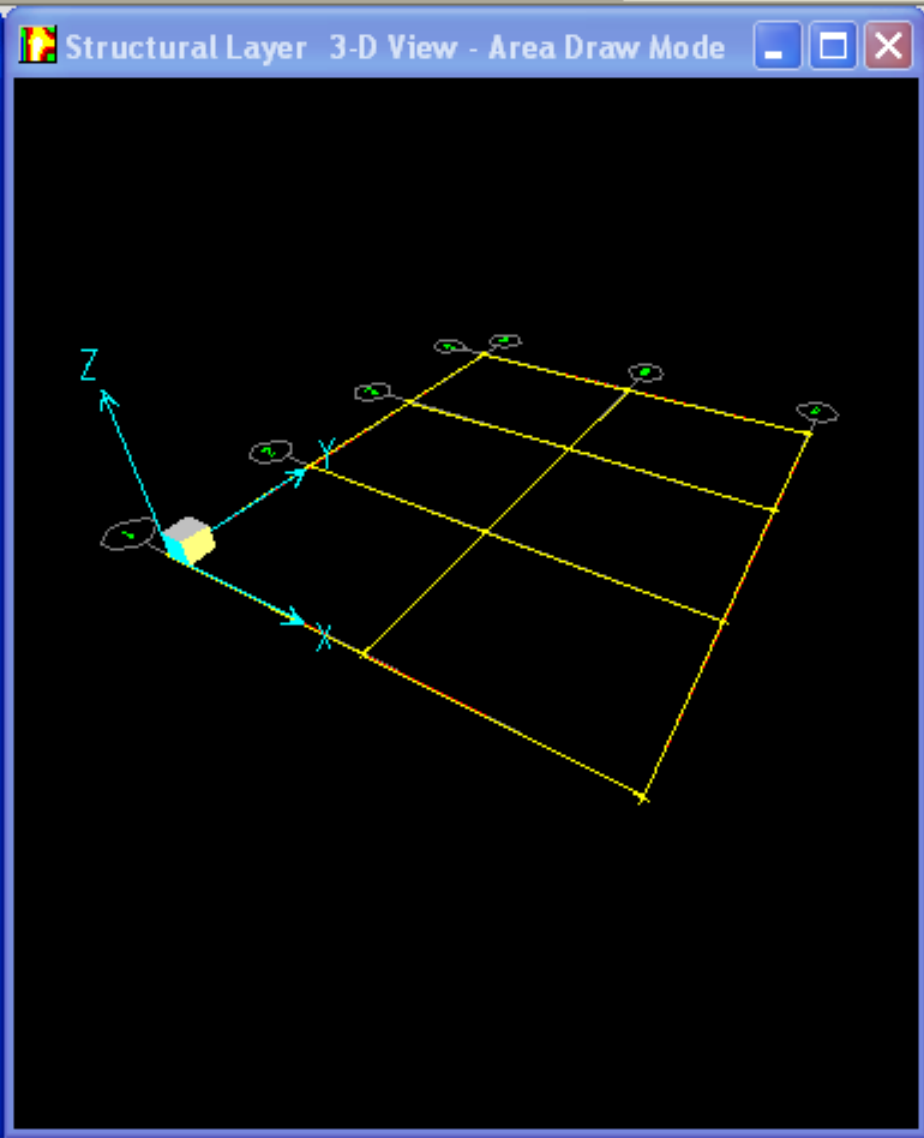
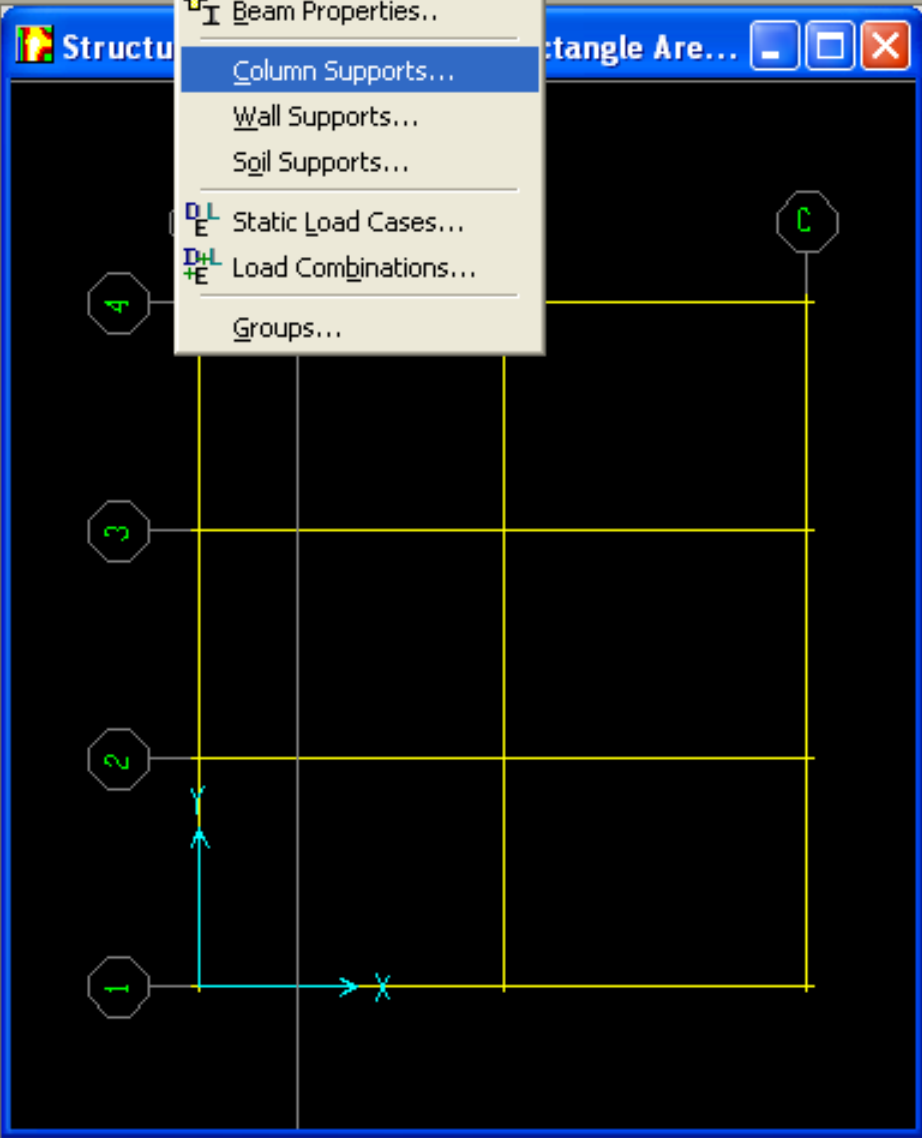
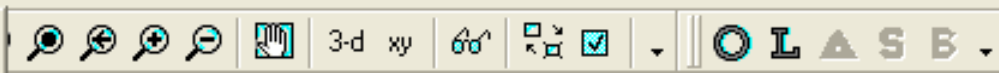

Click on first corner of rectangle

92.592 , 858.455

Kip-in

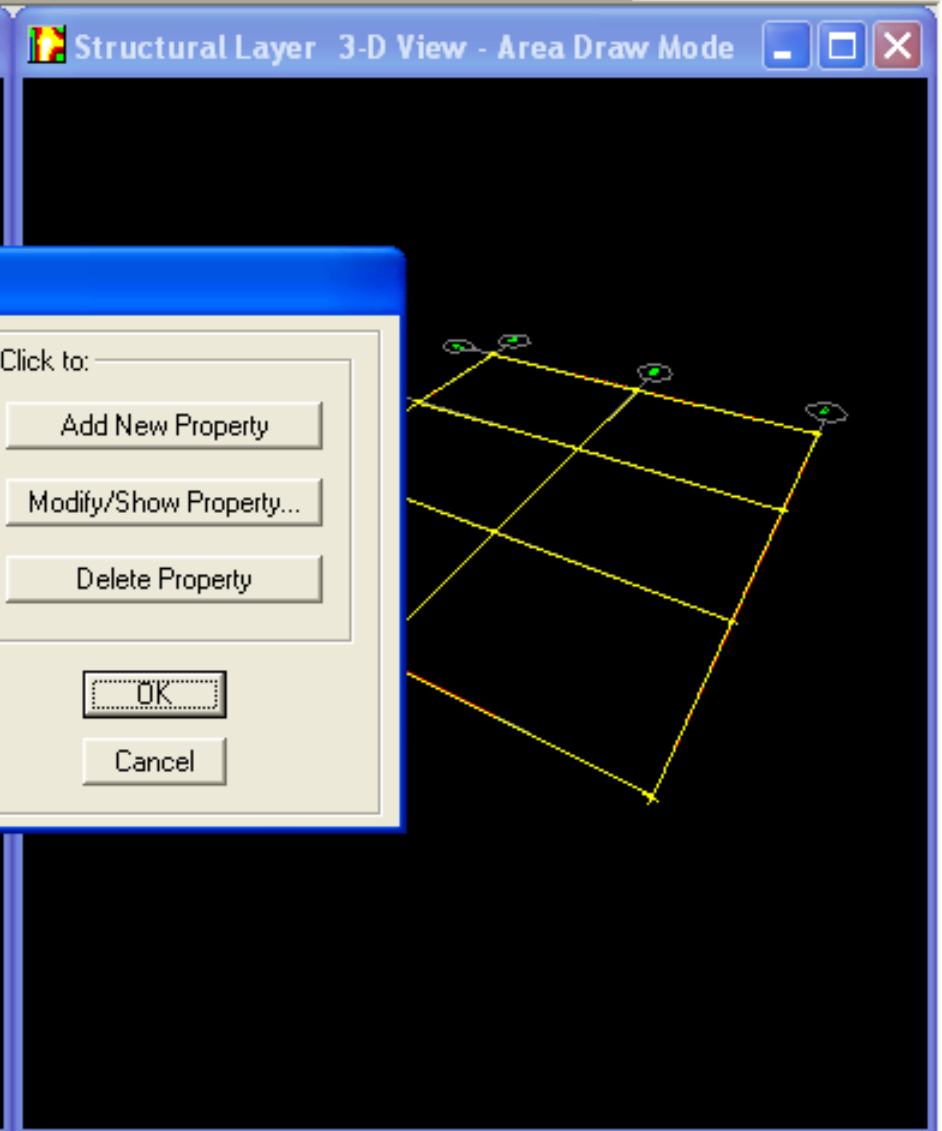
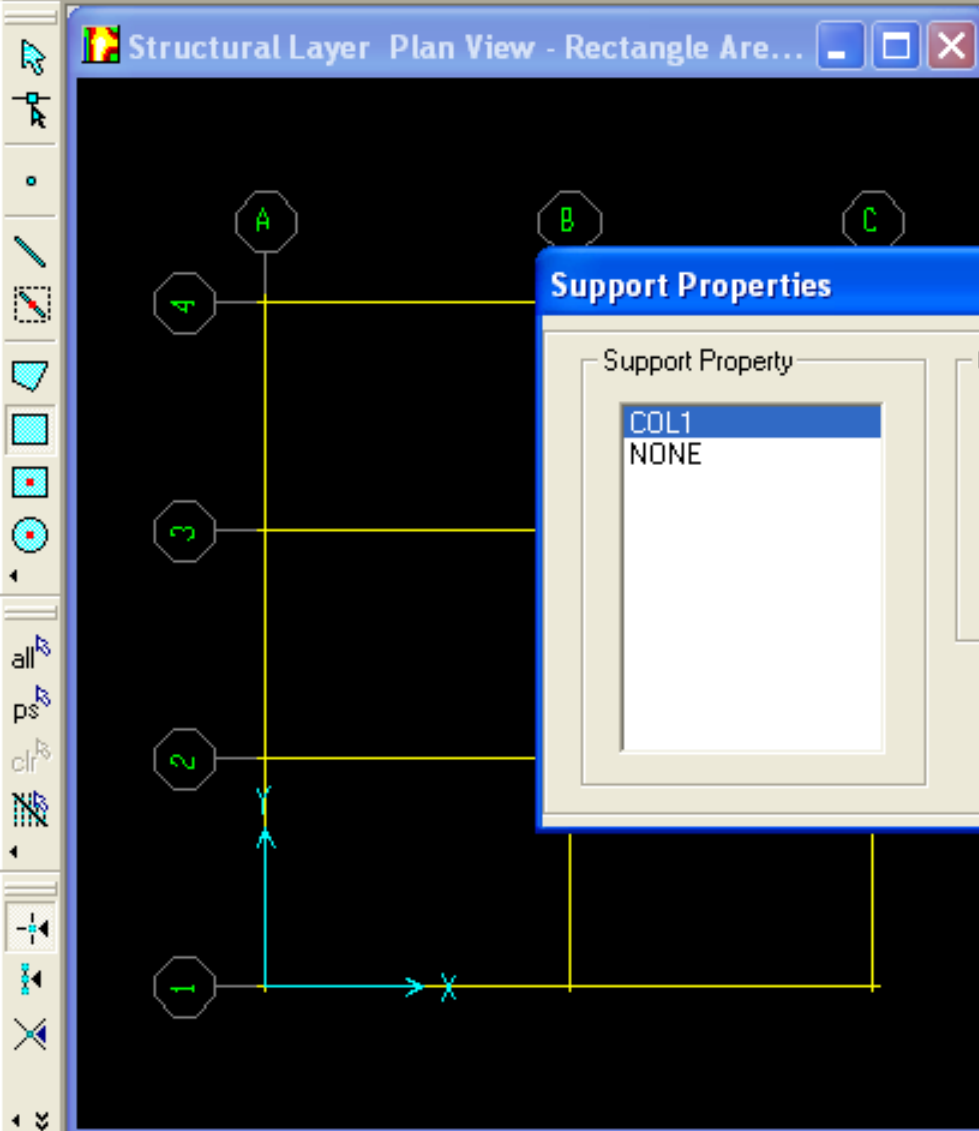

### Support Properties

Support Property

- COL1
- NONE

Click to:

Add New Property

Modify/Show Property...

Delete Property

OK

Cancel

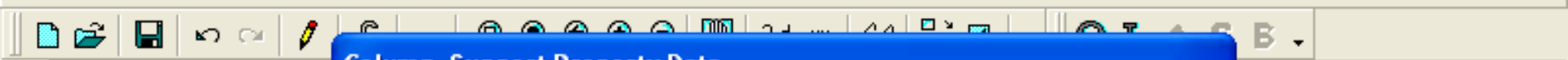

Structural Layer P

Area Draw Mode

Column Support Property Data

**Support Property Name** COL1

Define Column by:

Rectangular Properties  Circular Properties  Spring Constants

Activate Support Property:

Below Slab Only  Above Slab Only  Above and Below Slab

Properties Below Slab

Modulus of Elasticity	3122	X Capital	0.
Poisson's Ratio	0.2	Y Capital	0.
X Dimension	12.	Capital Height	0.
Y Dimension	12.	Column Height	120.

Spring Constants

Vertical		Properties Above Slab...
Rotate about X-axis		<input checked="" type="checkbox"/> Include Bending Stiffness
Rotate about Y-axis		

OK Cancel

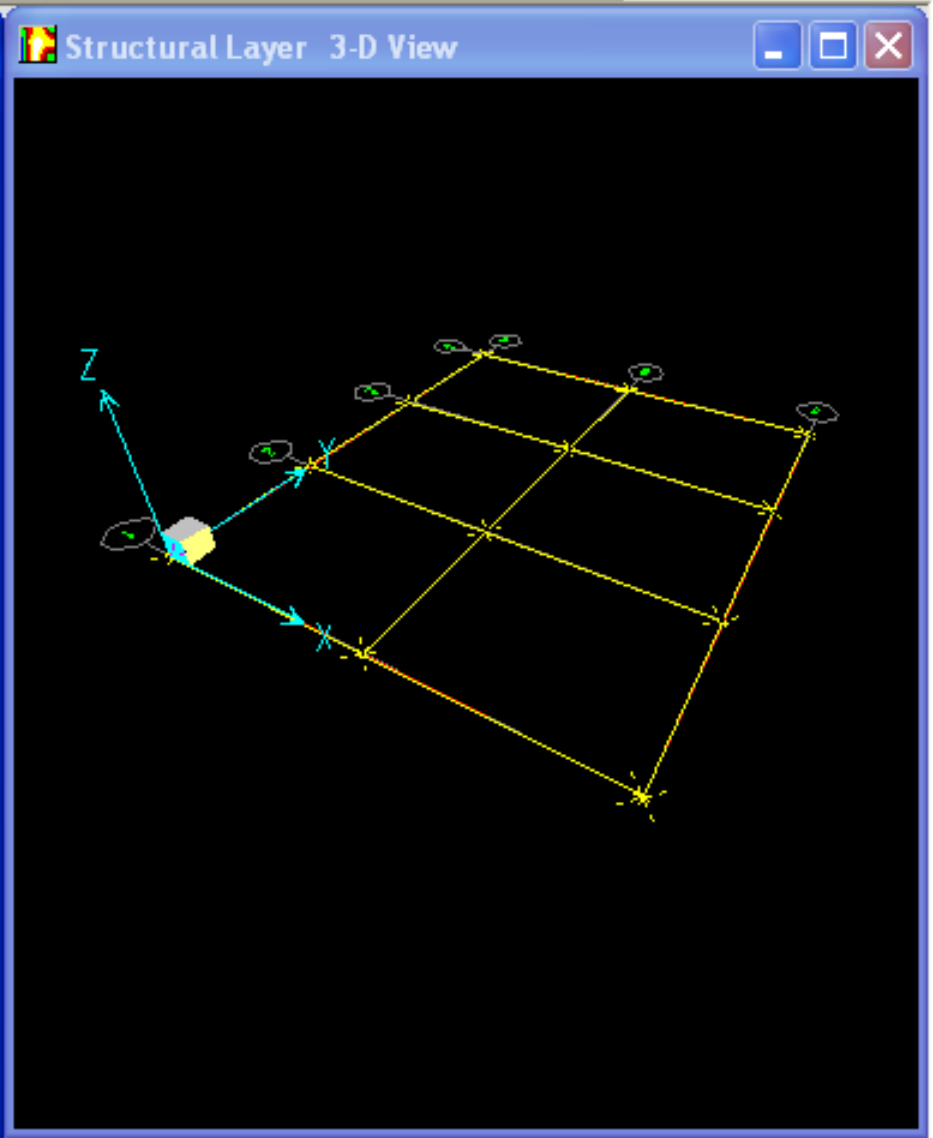
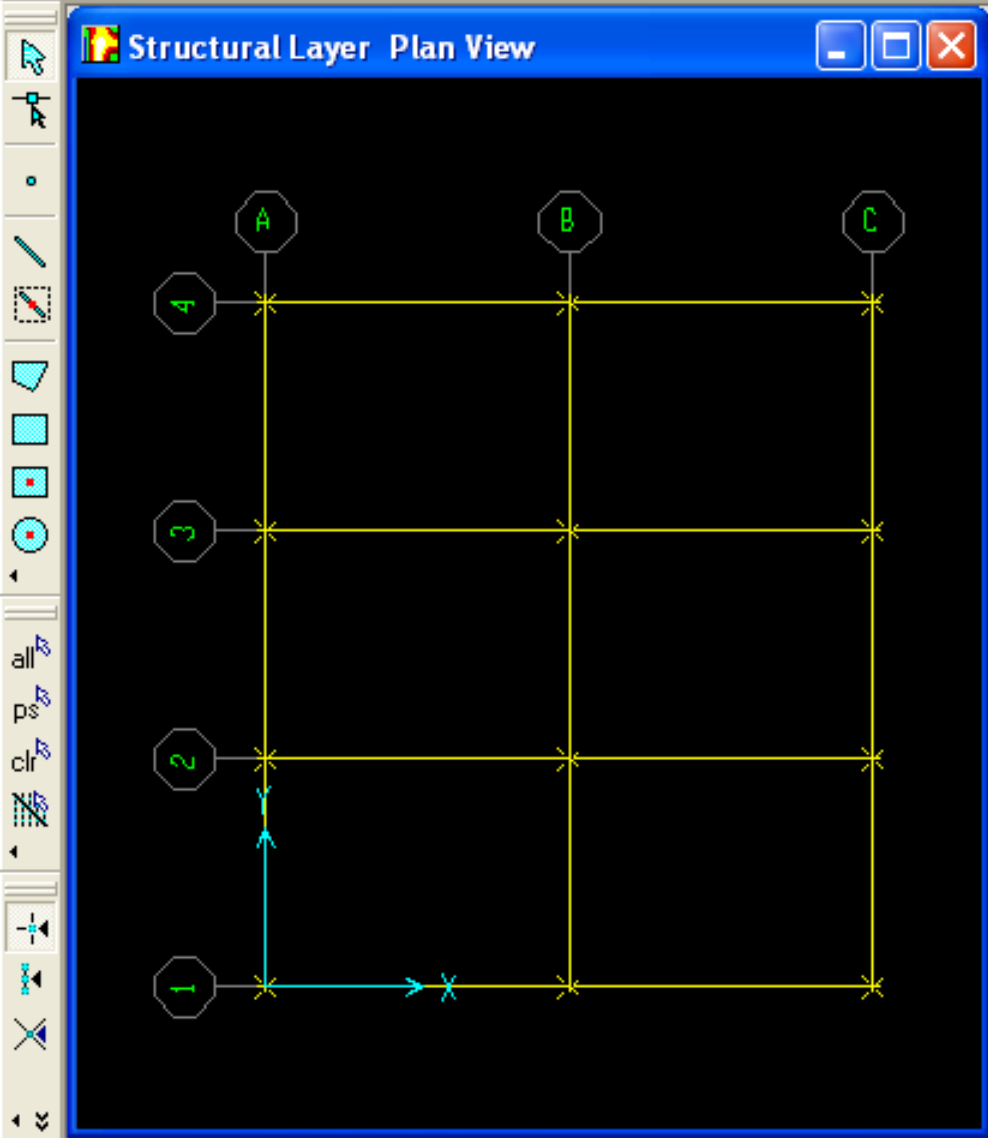



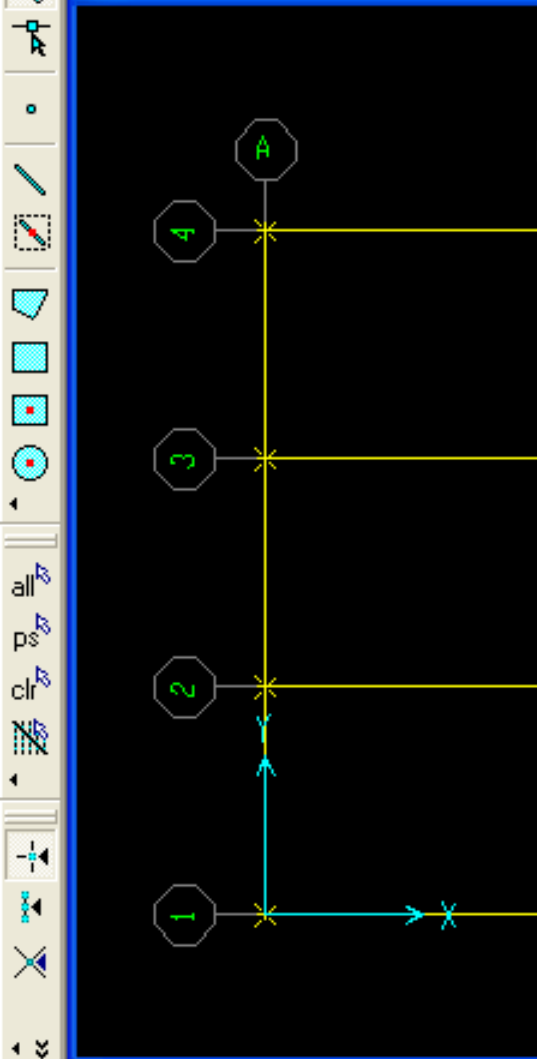

- Slab Properties...
- Slab Offset...
- Slab Rib Locations...
- Beam Properties...
- Beam Offset...
- Opening

---

- Point Restraints...
- Column Supports...**
- Wall Supports...
- Soil Supports...

---

- Releases...

---

- Point Loads...
- Point Displacements...
- Line Loads...
- Surface Loads...

---

- Group Names...
- Clear Display of Assigns

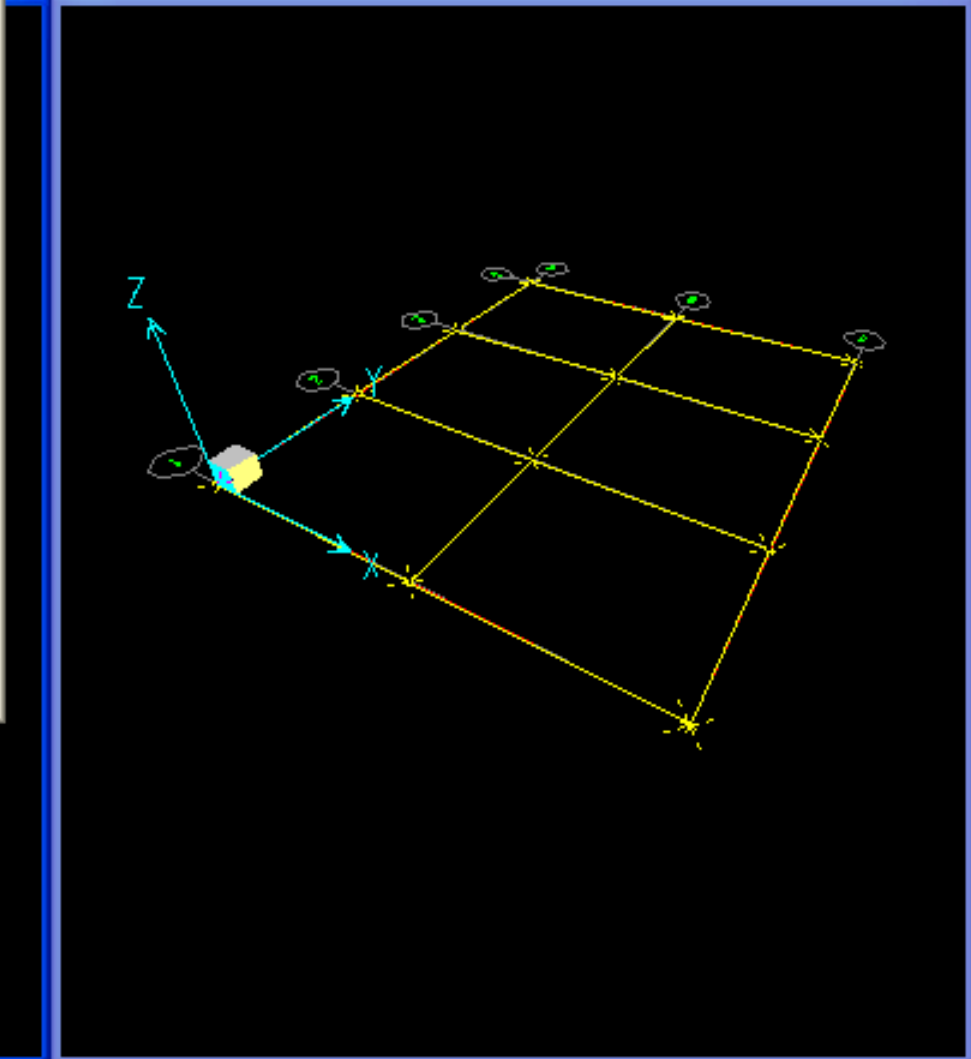

### Support Properties

Support Property

COL1
NONE

Click to:

Add New Property

Modify/Show Property...

Delete Property

OK

Cancel

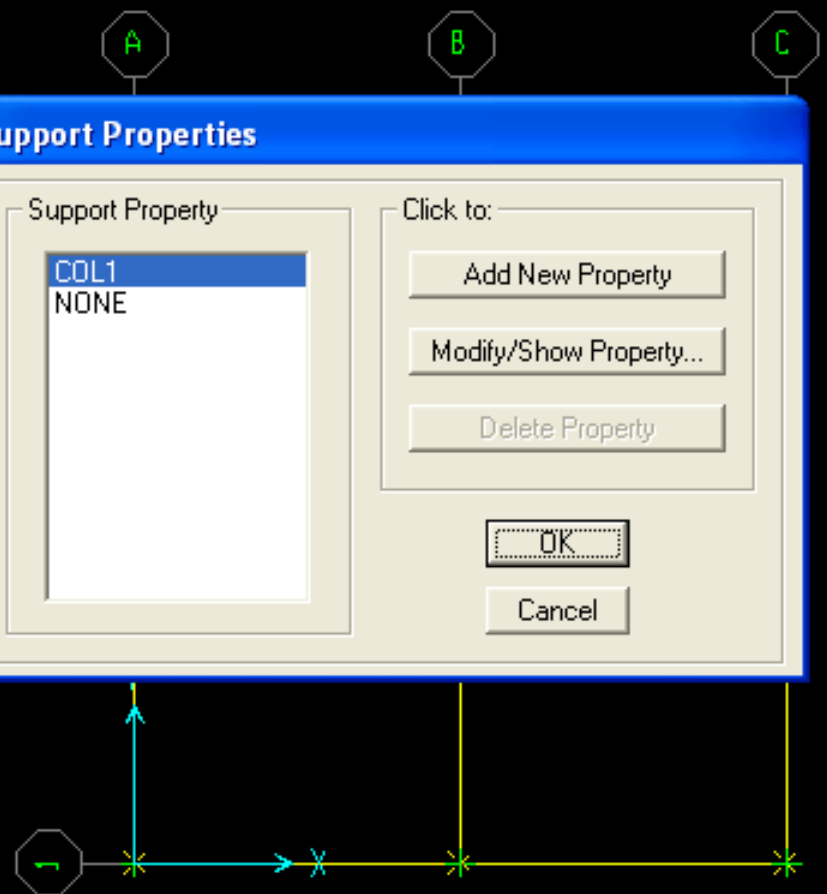

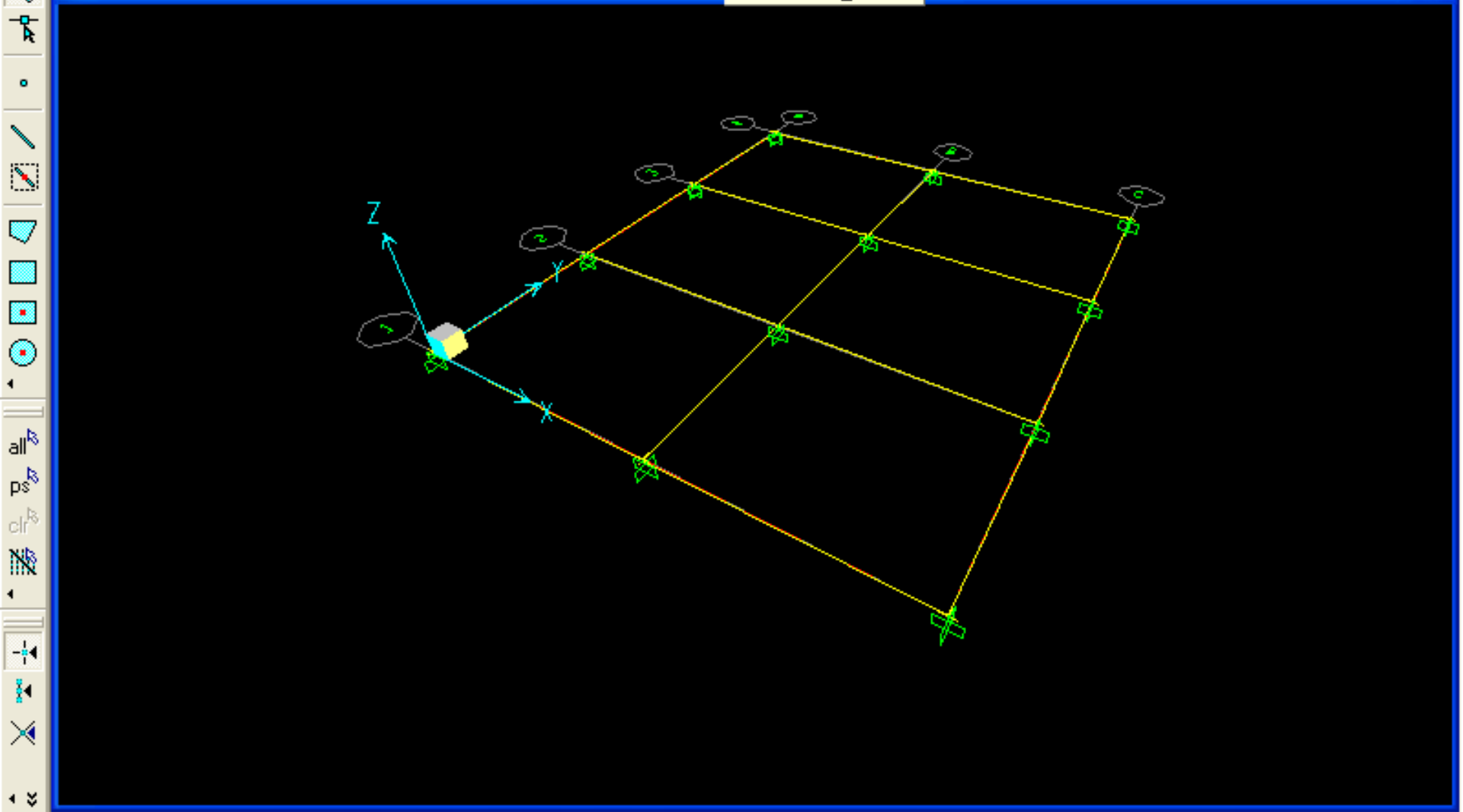

Structural Layer Plan View - Rectangle Area Draw Mode

[Vertical toolbar with icons for drawing tools: Line, Rectangle, Circle, etc.]

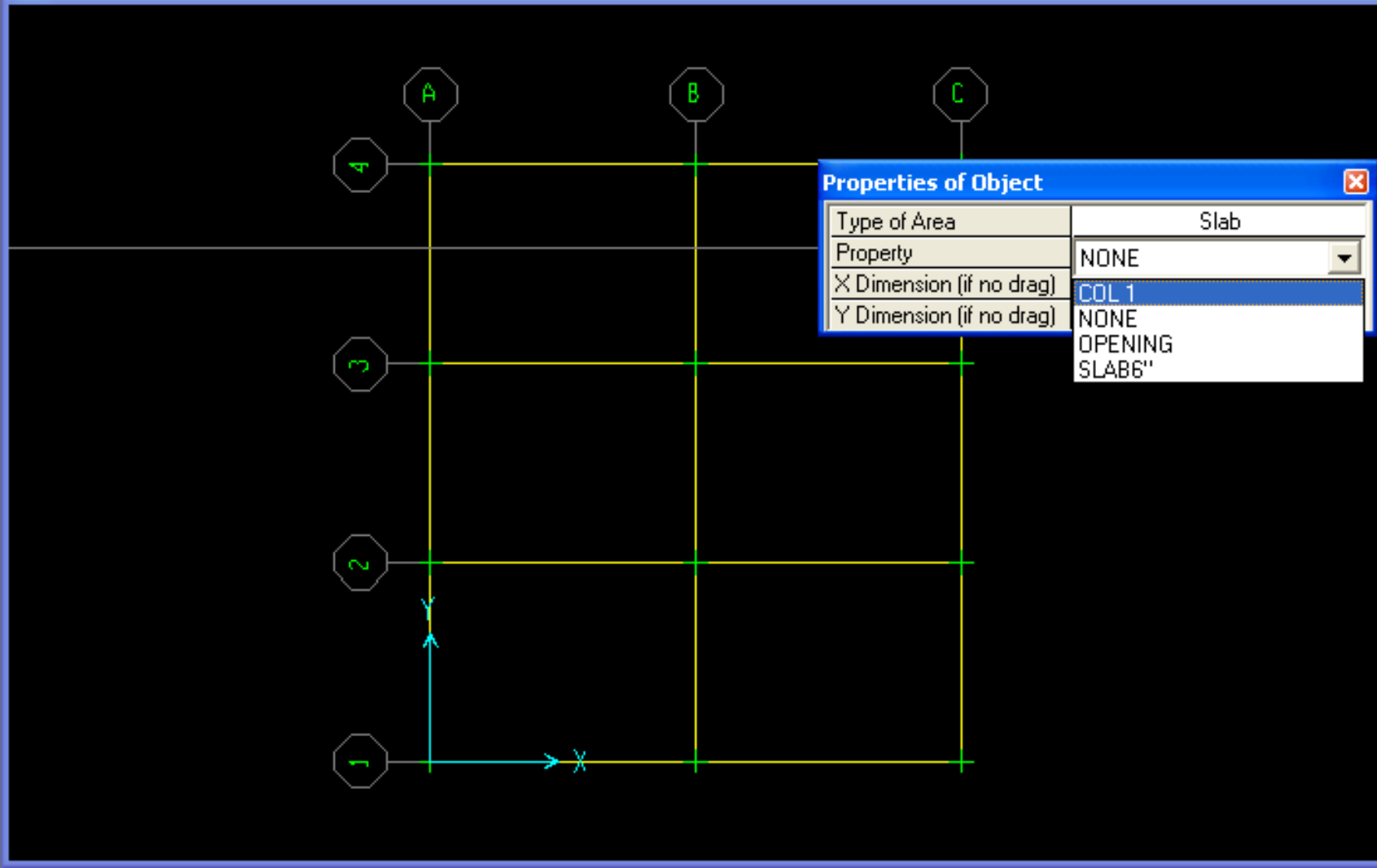

**Properties of Object**

Type of Area	Slab
Property	NONE
X Dimension (if no drag)	COL 1
Y Dimension (if no drag)	NONE
	OPENING
	SLAB6"

Click on first corner of rectangle

1032.972 , 557.712

Kip-in

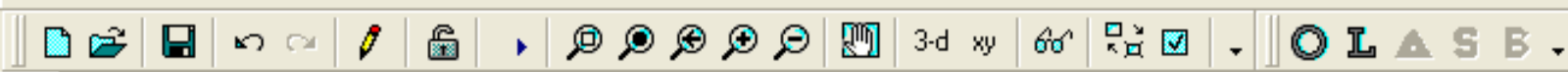

## Structural Layer Plan View - Rectangle Area Draw Mode

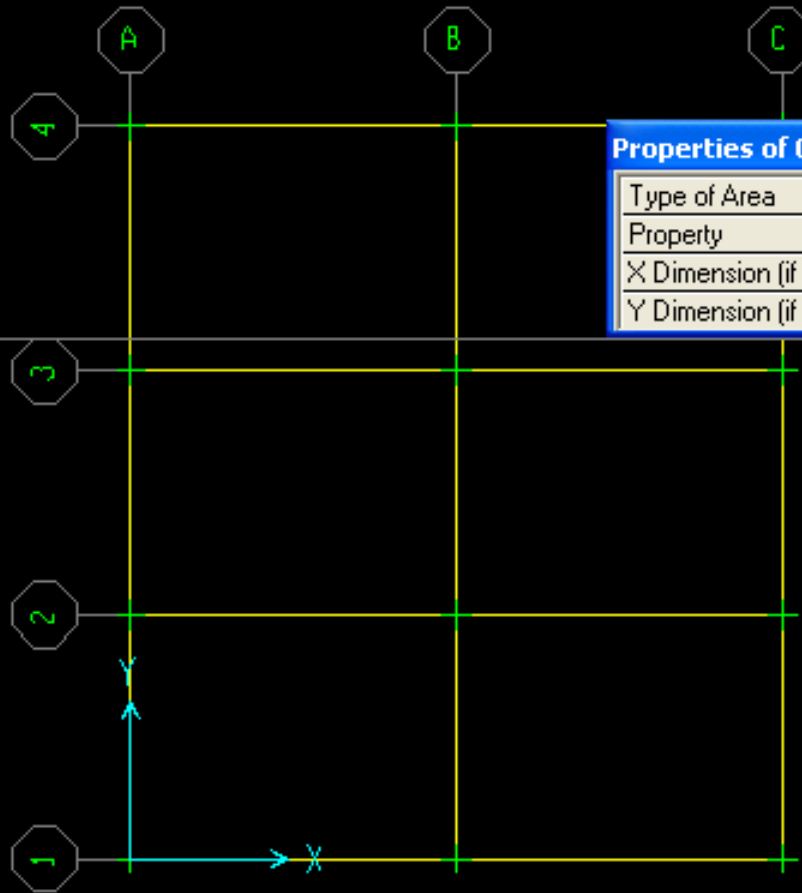

## Properties of Object

Type of Area	Slab
Property	COL 1
X Dimension (if no drag)	12
Y Dimension (if no drag)	12

Click on first corner of rectangle

886.488 , 460.056

Kip-in

Properties of Object

Type of Area	Slab
Property	COL 1
X Dimension (if no drag)	12.
Y Dimension (if no drag)	12.

## Structural Layer Plan View - Rectangle

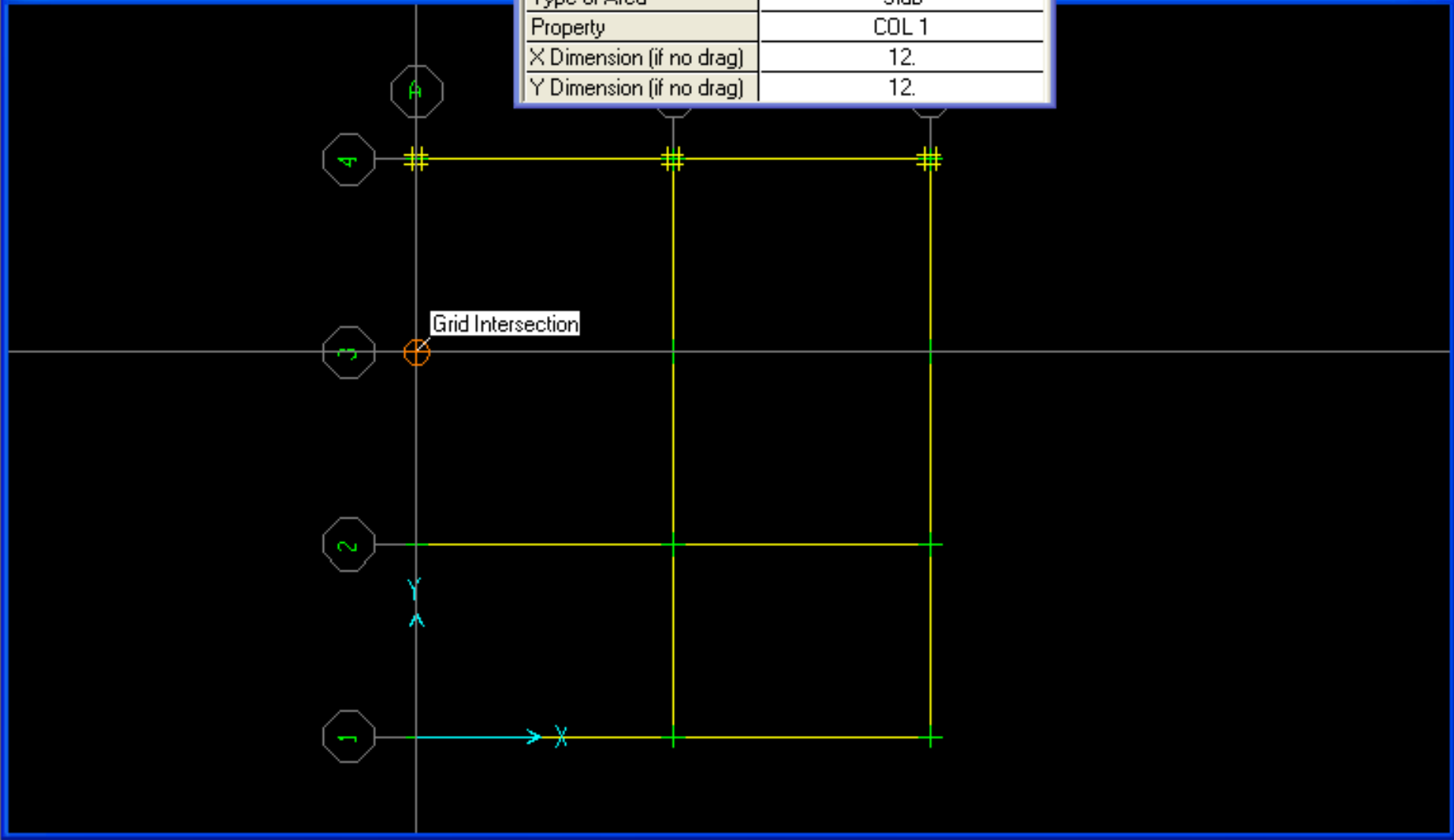

Structural Layer Plan View [-] [Maximize] [Close]

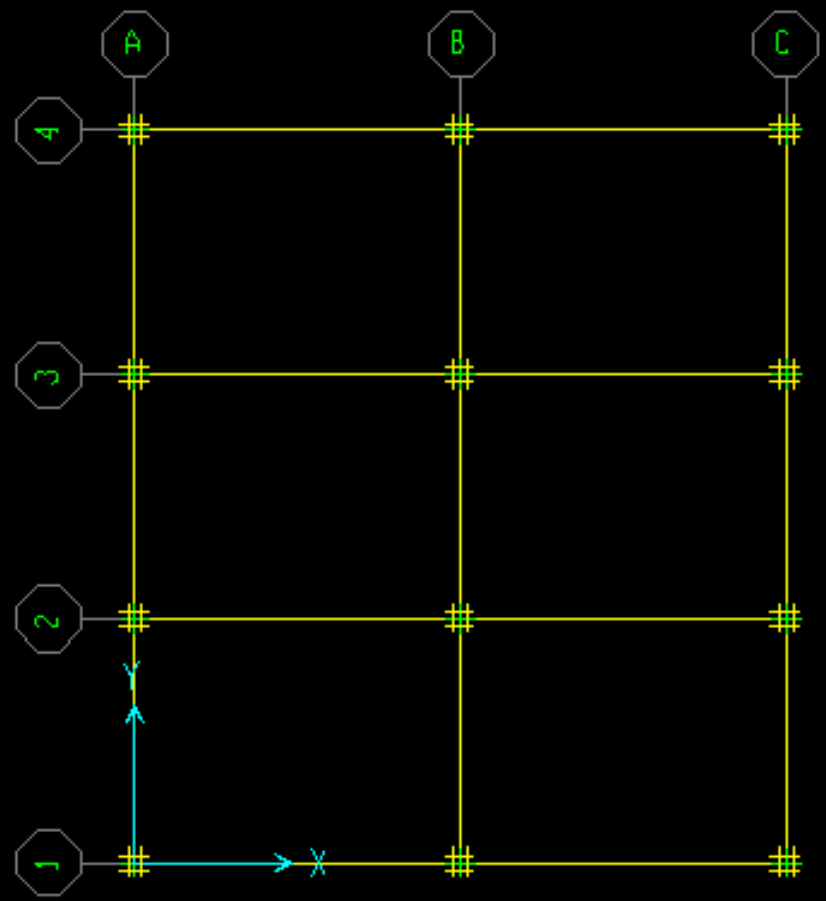

Structural Layer Plan View [-] [Maximize] [Close]

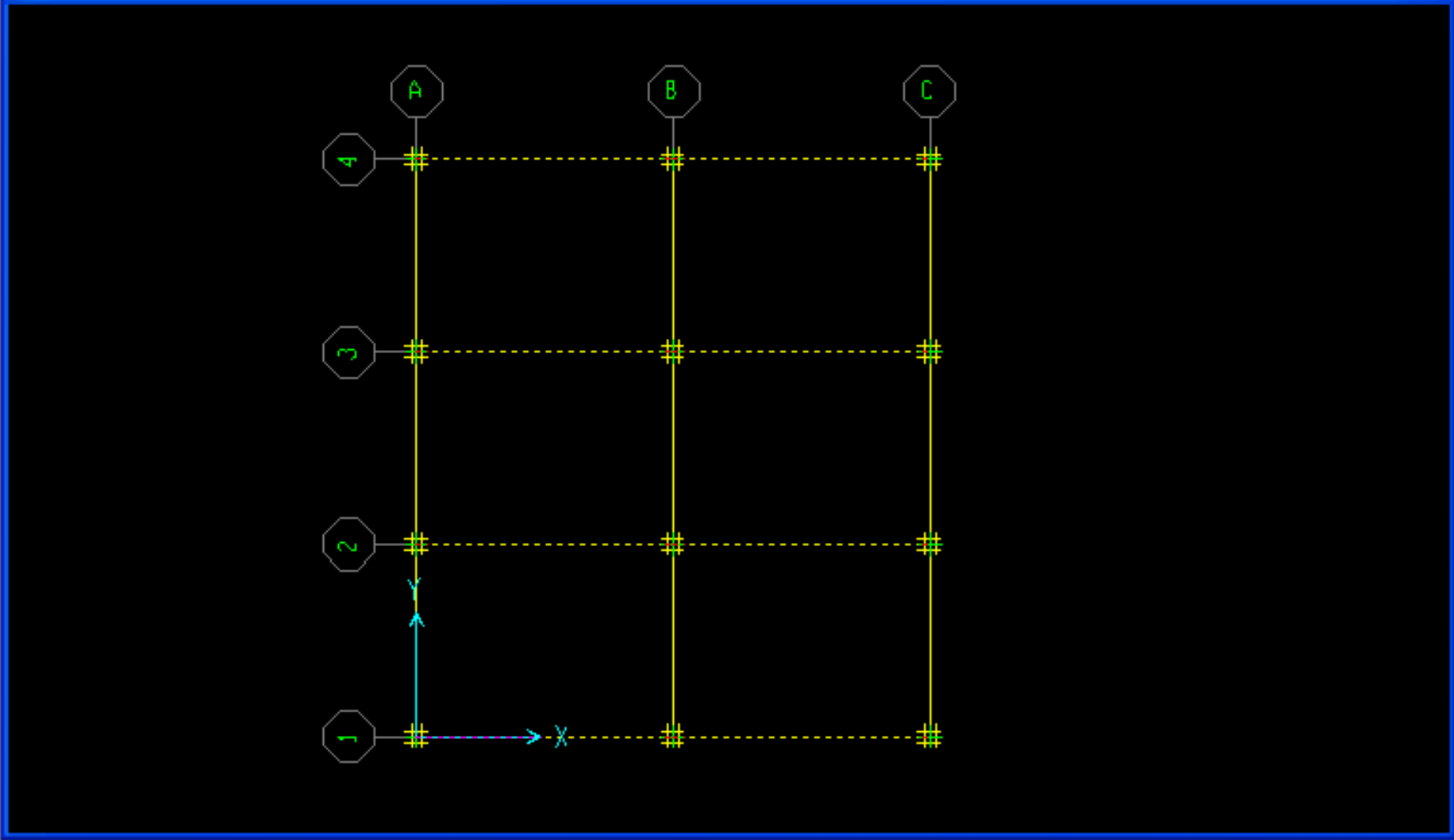



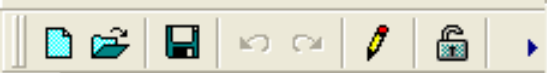

### Structural Layer Plan View

- Slab Properties...
- Slab Offset...
- Slab Rib Locations...
- Beam Properties...**
- Beam Offset...
- Opening
- Point Restraints...
- Column Supports...
- Wall Supports...
- Soil Supports...
- Releases...
- Point Loads...
- Point Displacements...
- Line Loads...
- Surface Loads...
- Group Names...
- Clear Display of Assigns

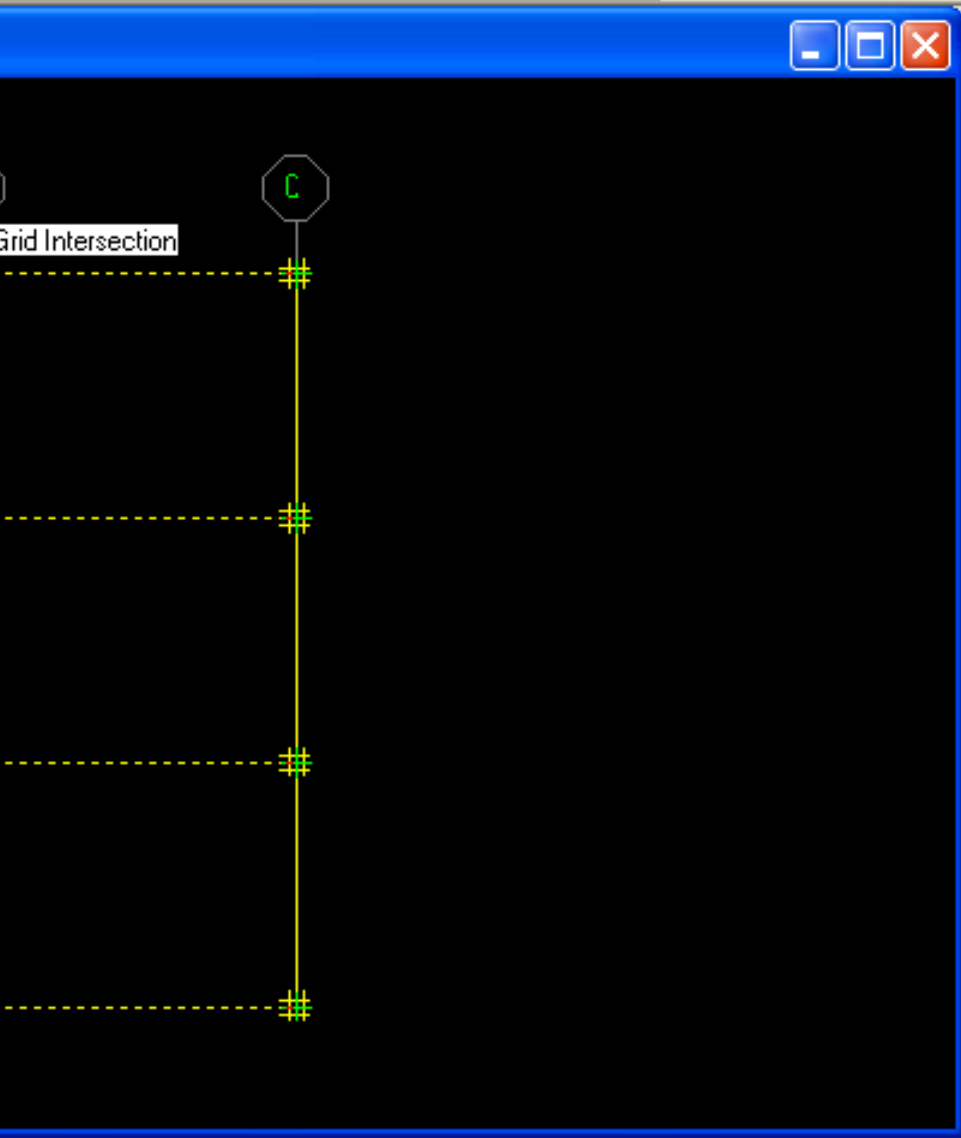

8 Lines selected

288.000 , 648.000

Kip-in

### Beam Properties

Beam Property

- B1
- B2
- NONE

Click to:

Add Rectangular Beam

Modify/Show Property...

Delete Property

OK

Cancel

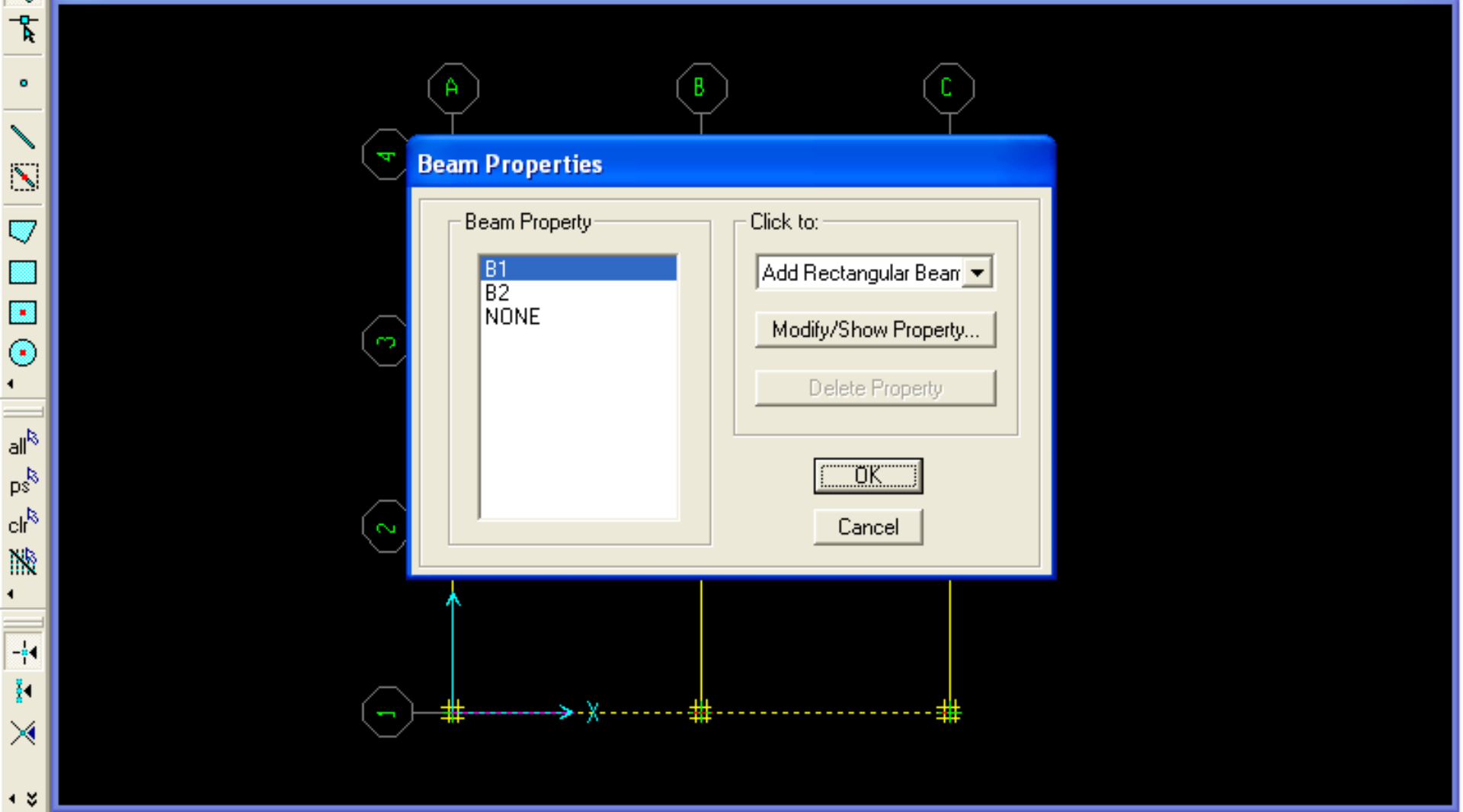

Structural Layer Plan View [-] [Maximize] [Close]

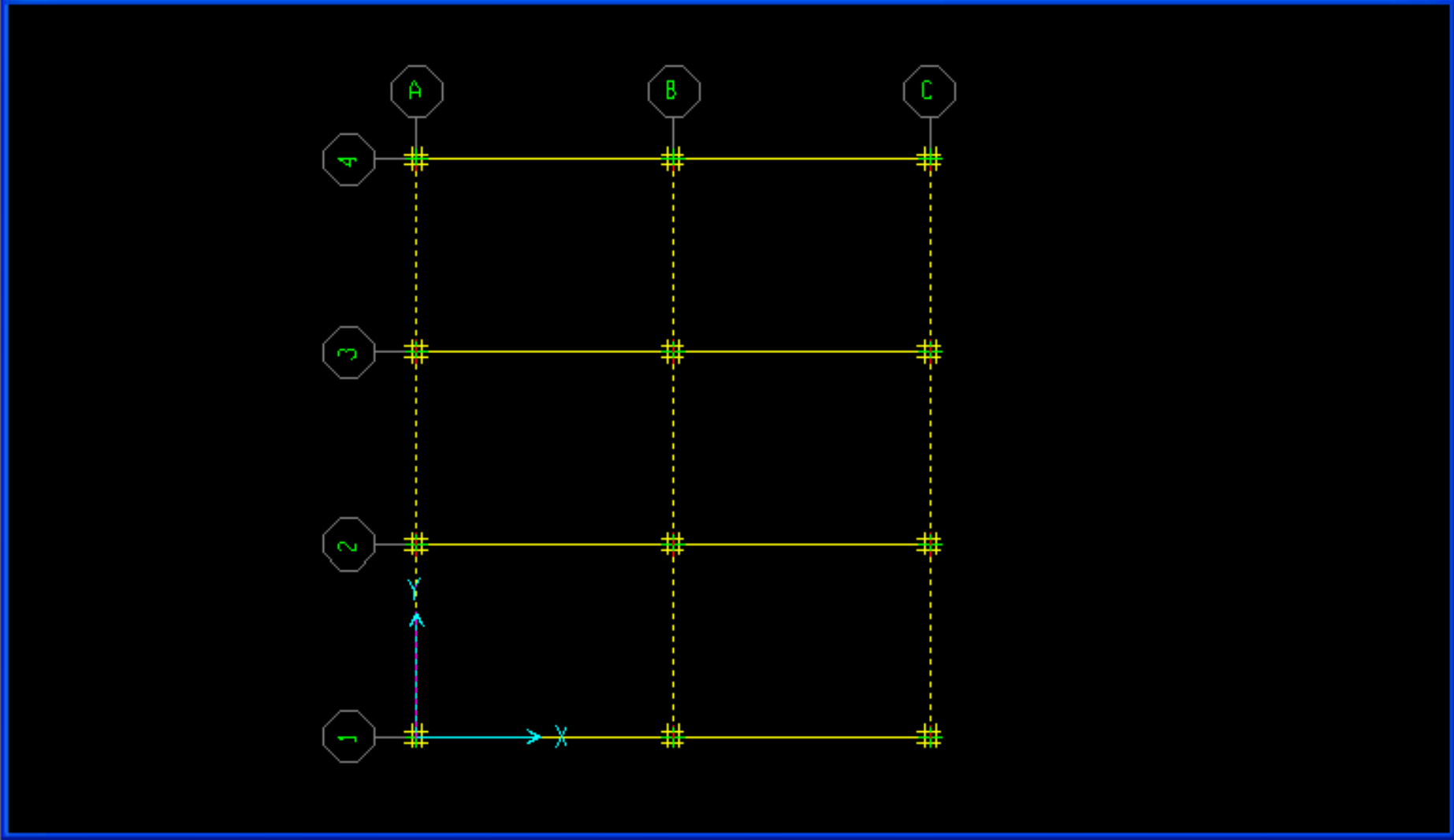

### Beam Properties

Beam Property

- B1
- B2**
- NONE

Click to:

Add Rectangular Beam ▾

Modify/Show Property...

Delete Property

OK

Cancel

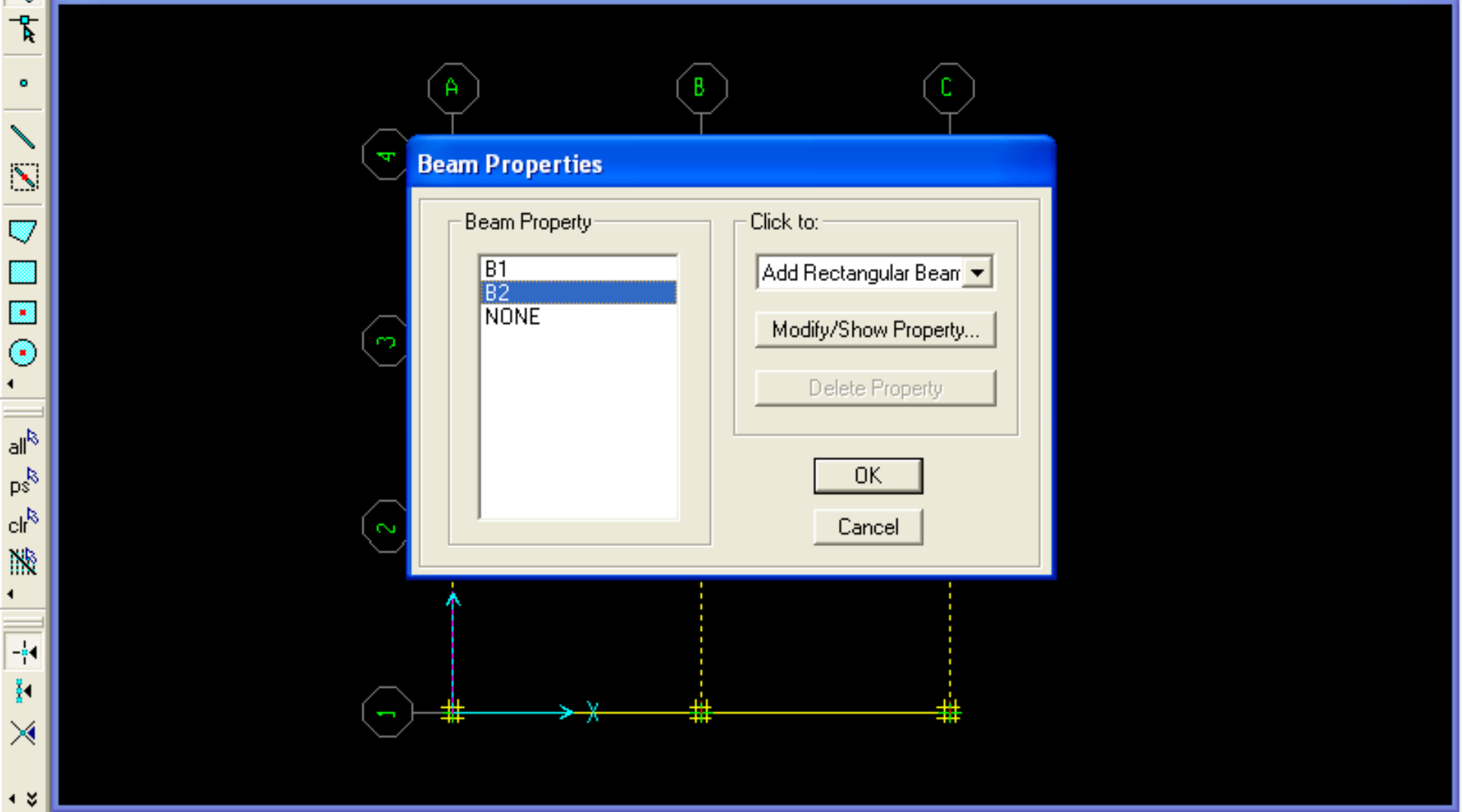

Structural Layer Plan View [-] [Maximize] [Close]

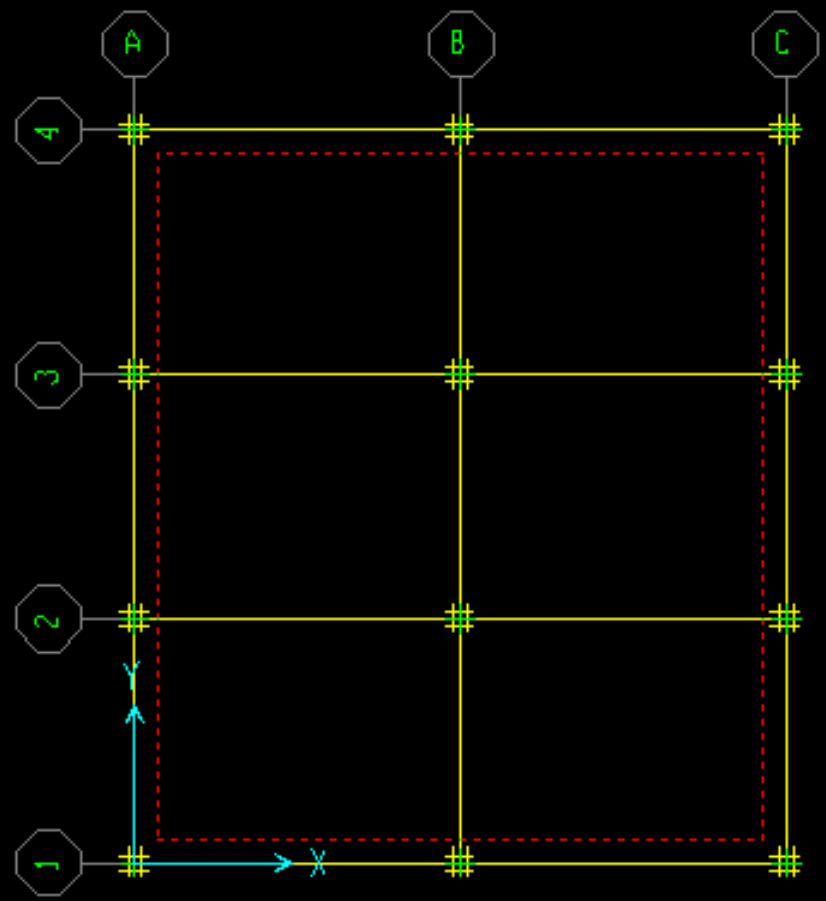

**Structural Layer Plan View**

all  
p  
cl

- Slab Properties...
- Slab Offset...
- Slab Rib Locations...
- Beam Properties...
- Beam Offset...
- Opening
- Point Restraints...
- Column Supports...
- Wall Supports...
- Soil Supports...
- Releases...
- Point Loads...
- Point Displacements...
- Line Loads...
- Surface Loads...
- Group Names...
- Clear Display of Assigns

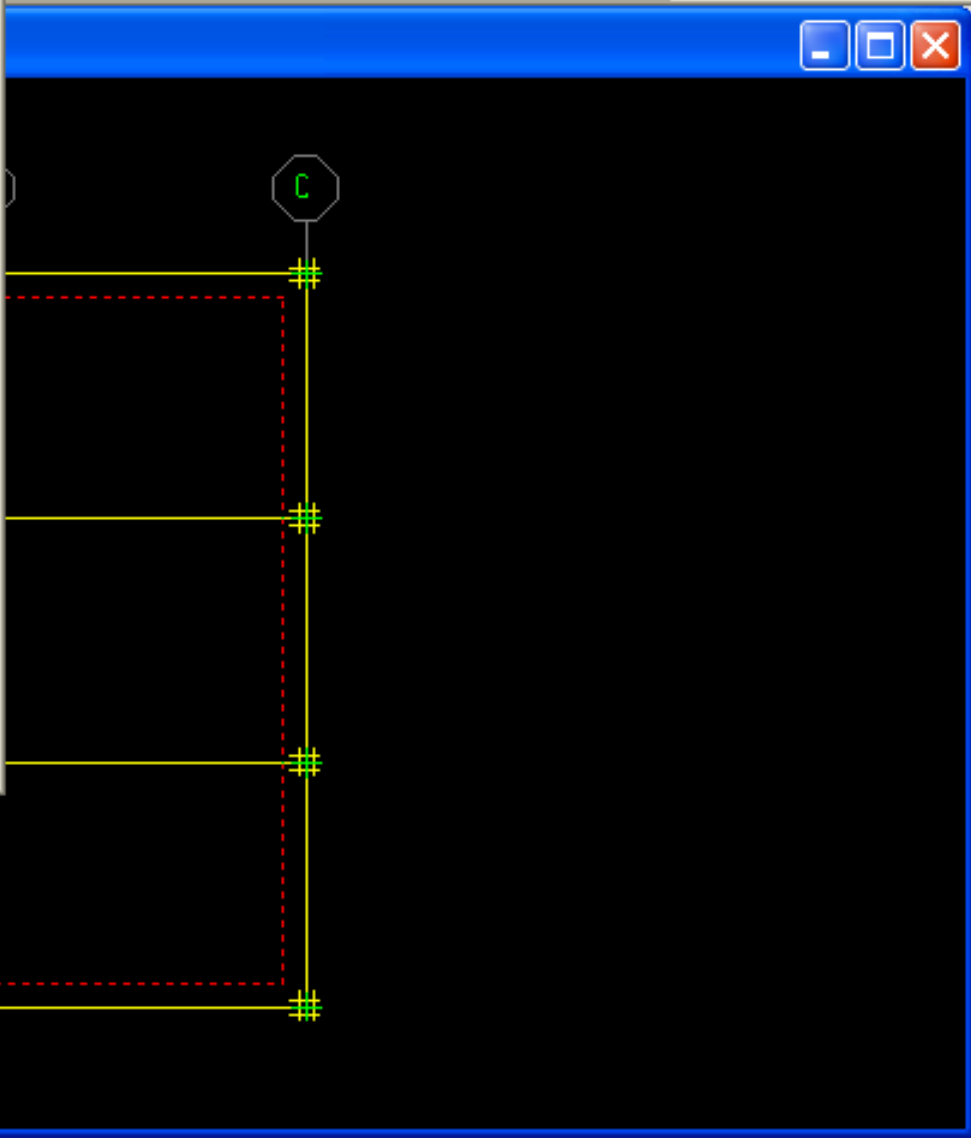

### Slab Properties

Slab Property

- COL 1
- NONE
- SLAB6"**

Click to:

- Add New Property
- Modify/Show Property...
- Delete Property

OK

Cancel

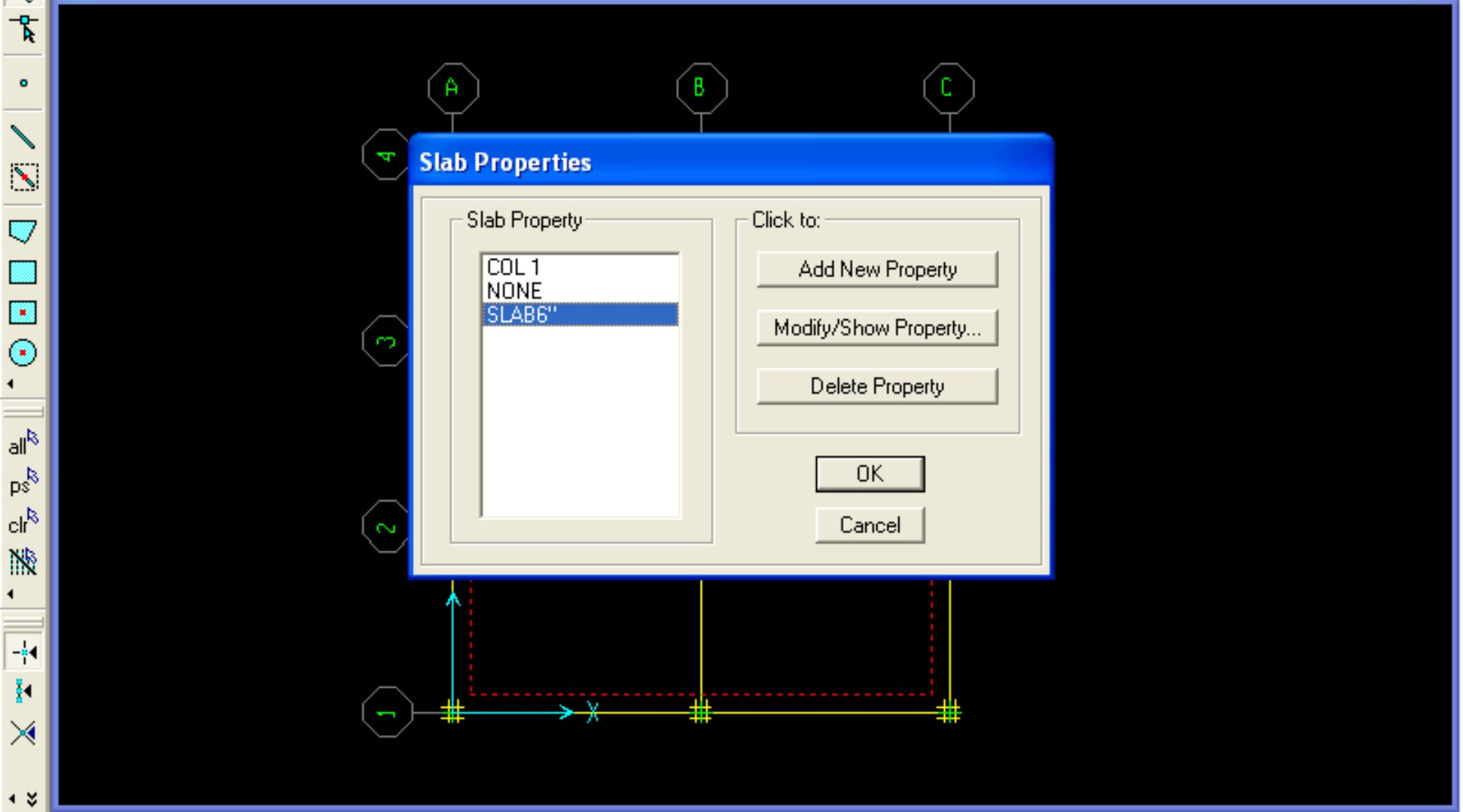

[Vertical toolbar with icons for selection, drawing, and editing]

### Slab Properties

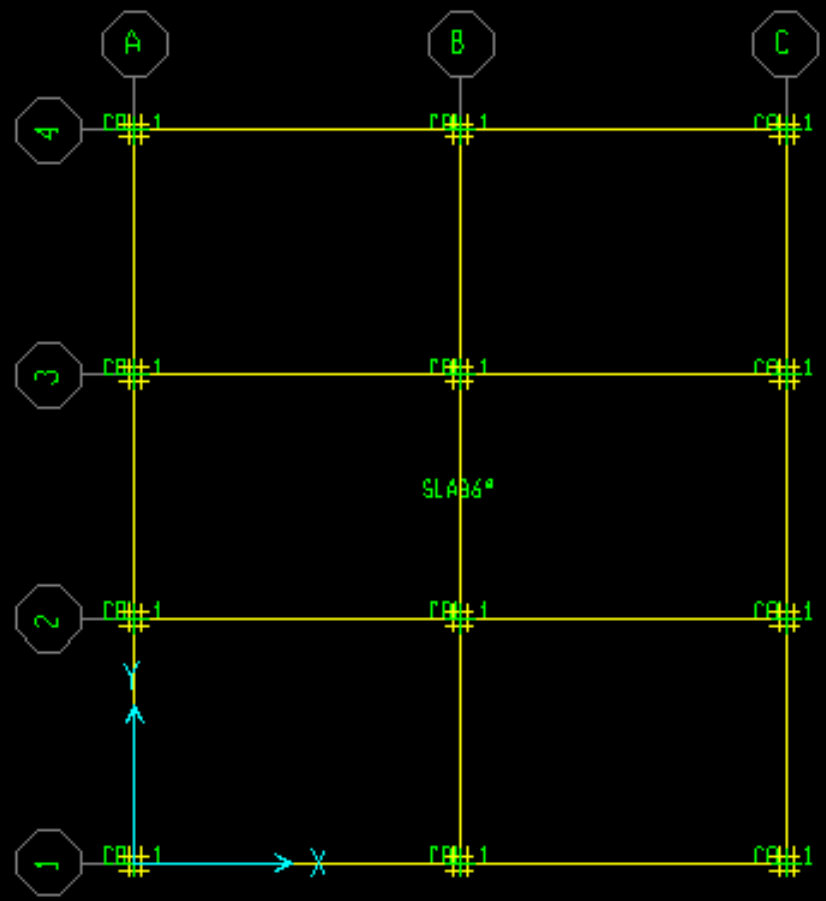



- Slab Properties...
- Beam Properties...
- Column Supports...
- Wall Supports...
- Soil Supports...
- DL**  
**E** Static Load Cases...
- DL**  
**+E** Load Combinations...
- Groups...

Structu

all  
pos  
cl

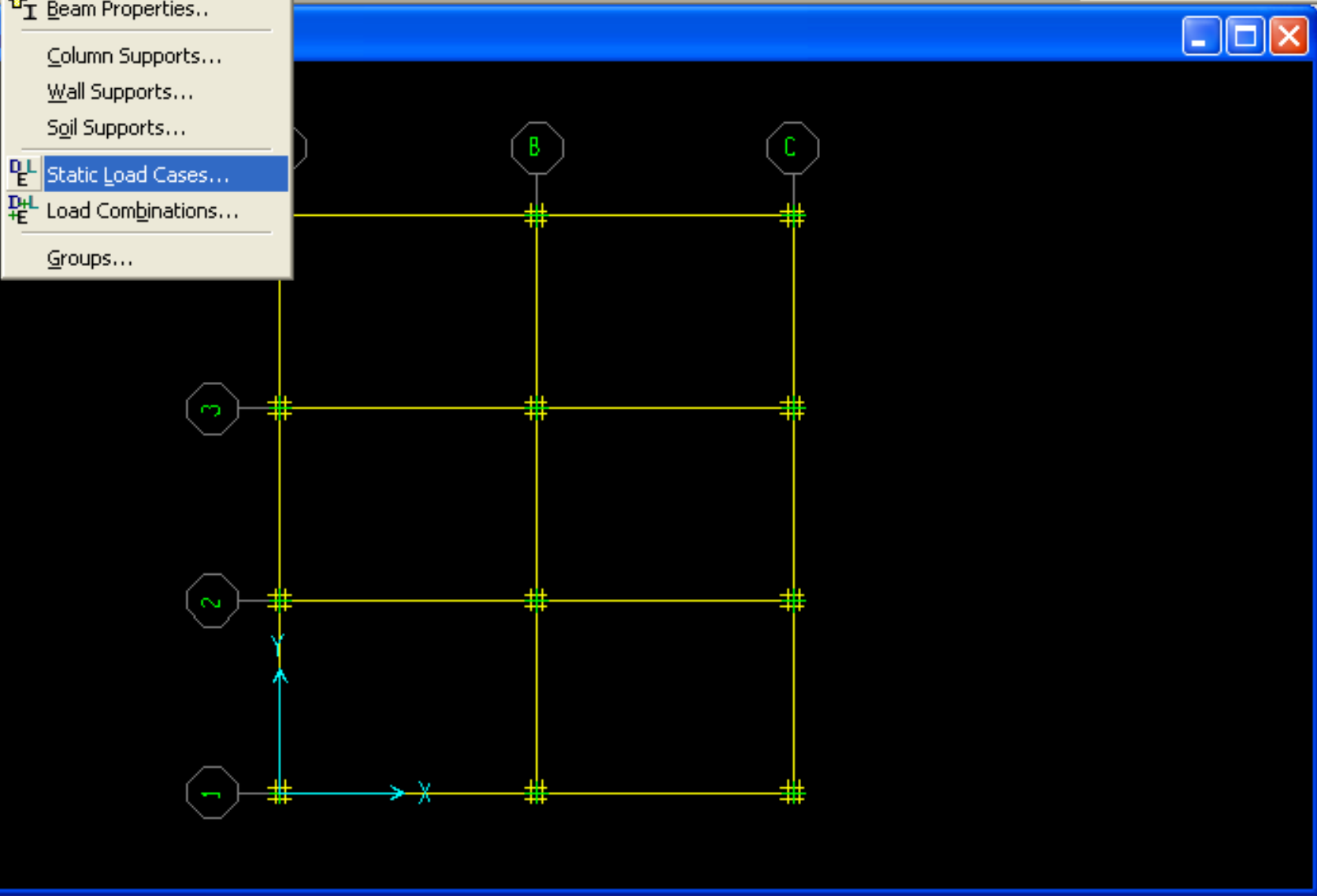

### Static Load Case Names

Click to:

- Add New Load
- Modify Load
- Delete Load

Load	Type	Self Weight Multiplier	Long Term Deflection Multiplier
DEAD	DEAD	1.	3.
DEAD	DEAD	1.	3.

OK

Cancel

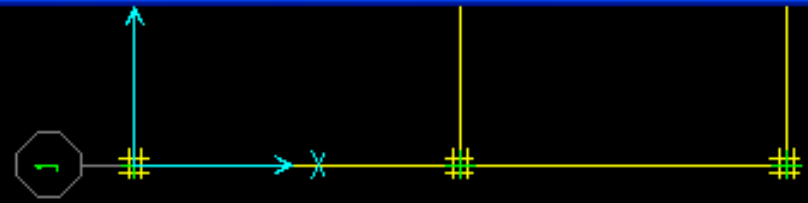

### Static Load Case Names

Click to:

Add New Load

Modify Load

Delete Load

OK

Cancel

Load	Type	Self Weight Multiplier	Long Term Deflection Multiplier
LIVE	DEAD	1.	3.
DEAD	DEAD	1.	3.
	LIVE		
	PATTERN LIVE		
	QUAKE		
	WIND		
	SNOW		
	OTHER		

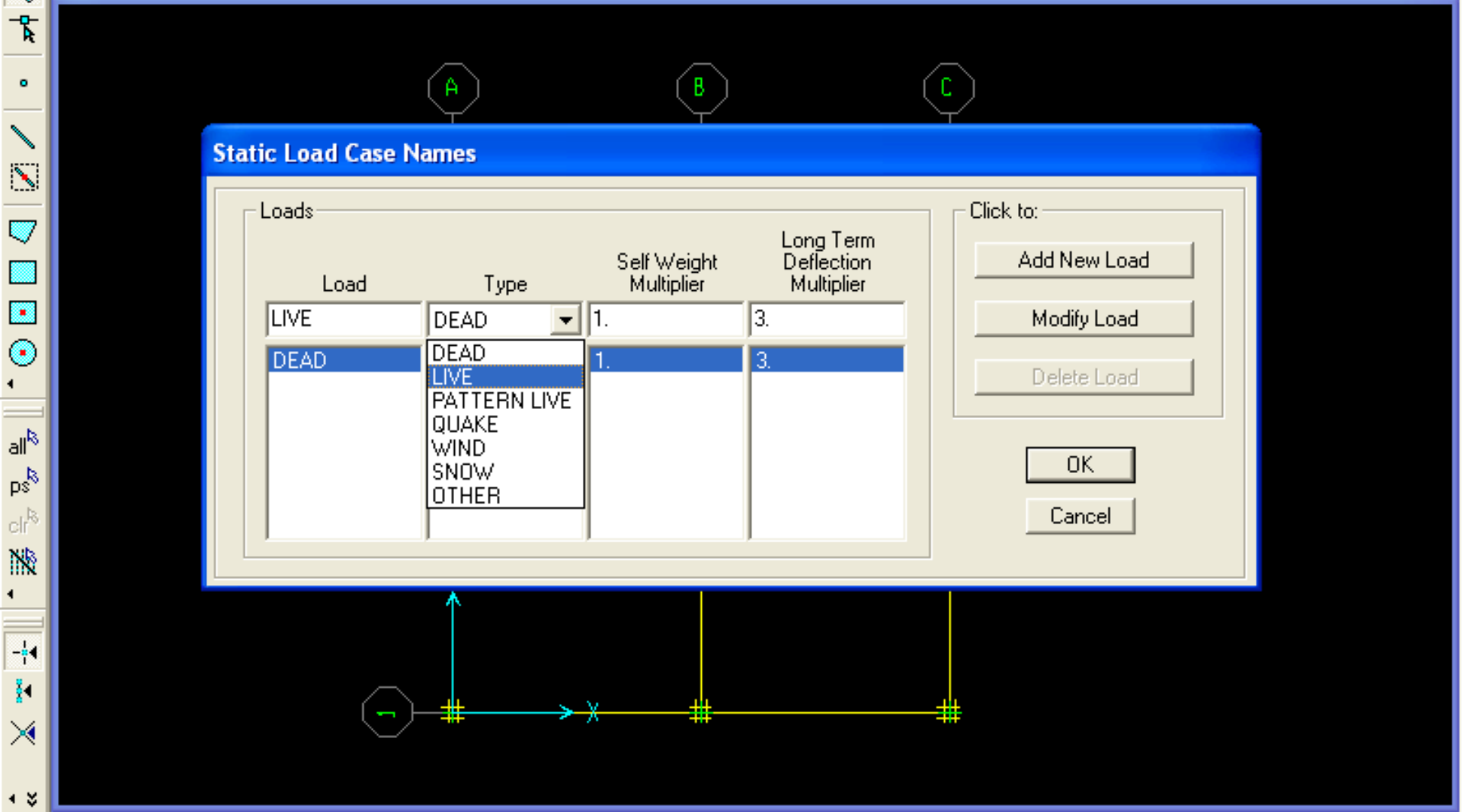

### Static Load Case Names

Loads

Load	Type	Self Weight Multiplier	Long Term Deflection Multiplier
LIVE	LIVE	0	1
DEAD	DEAD	1.	3.
LIVE	LIVE	0	1

Click to:

Add New Load

Modify Load

Delete Load

OK

Cancel

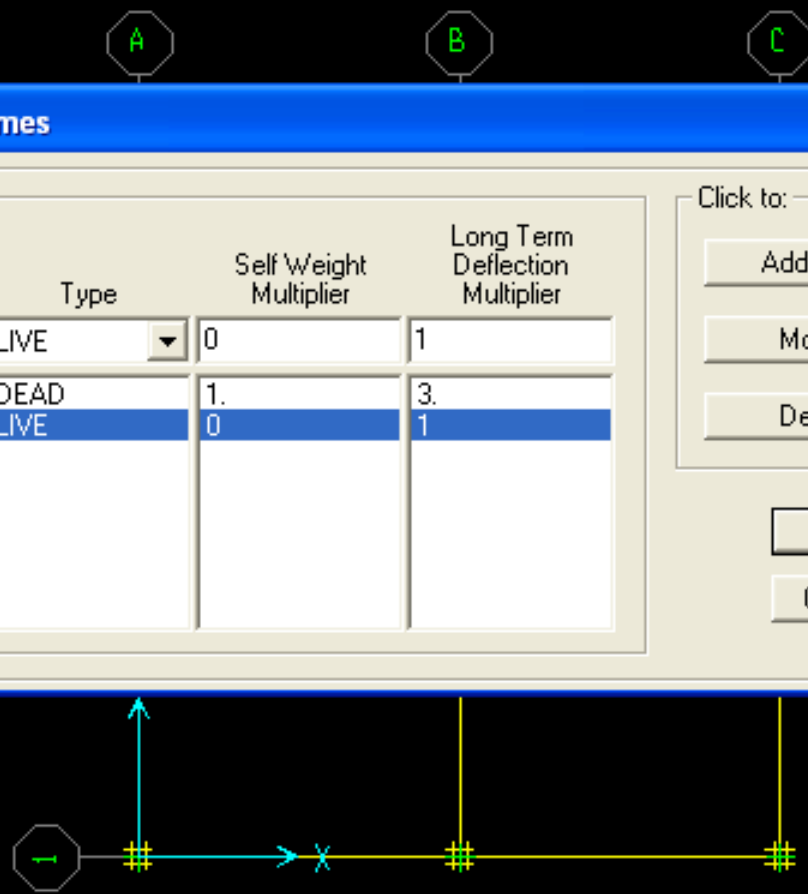

### Set Objects

Area Objects	Line Objects	Point Objects
<input type="checkbox"/> Labels	<input type="checkbox"/> Labels	<input type="checkbox"/> Labels
<input type="checkbox"/> Properties	<input type="checkbox"/> Properties	<input checked="" type="checkbox"/> Point Supports
<input type="checkbox"/> Area Supports	<input checked="" type="checkbox"/> Line Supports	<input type="checkbox"/> Hide
<input type="checkbox"/> Fill Elements	<input type="checkbox"/> Hide X-Objects	
<input type="checkbox"/> Show Edges	<input type="checkbox"/> Hide Y-Objects	
<input type="checkbox"/> Hide		

Options

<input type="checkbox"/> Shrink Elements	<input checked="" type="checkbox"/> Show Extrusions
<input type="checkbox"/> Show Mesh	<input type="checkbox"/> Show Releases
<input type="checkbox"/> Show Internal Ribs	

OK Cancel

Structural Layer 3-D View

[Vertical toolbar with various icons]

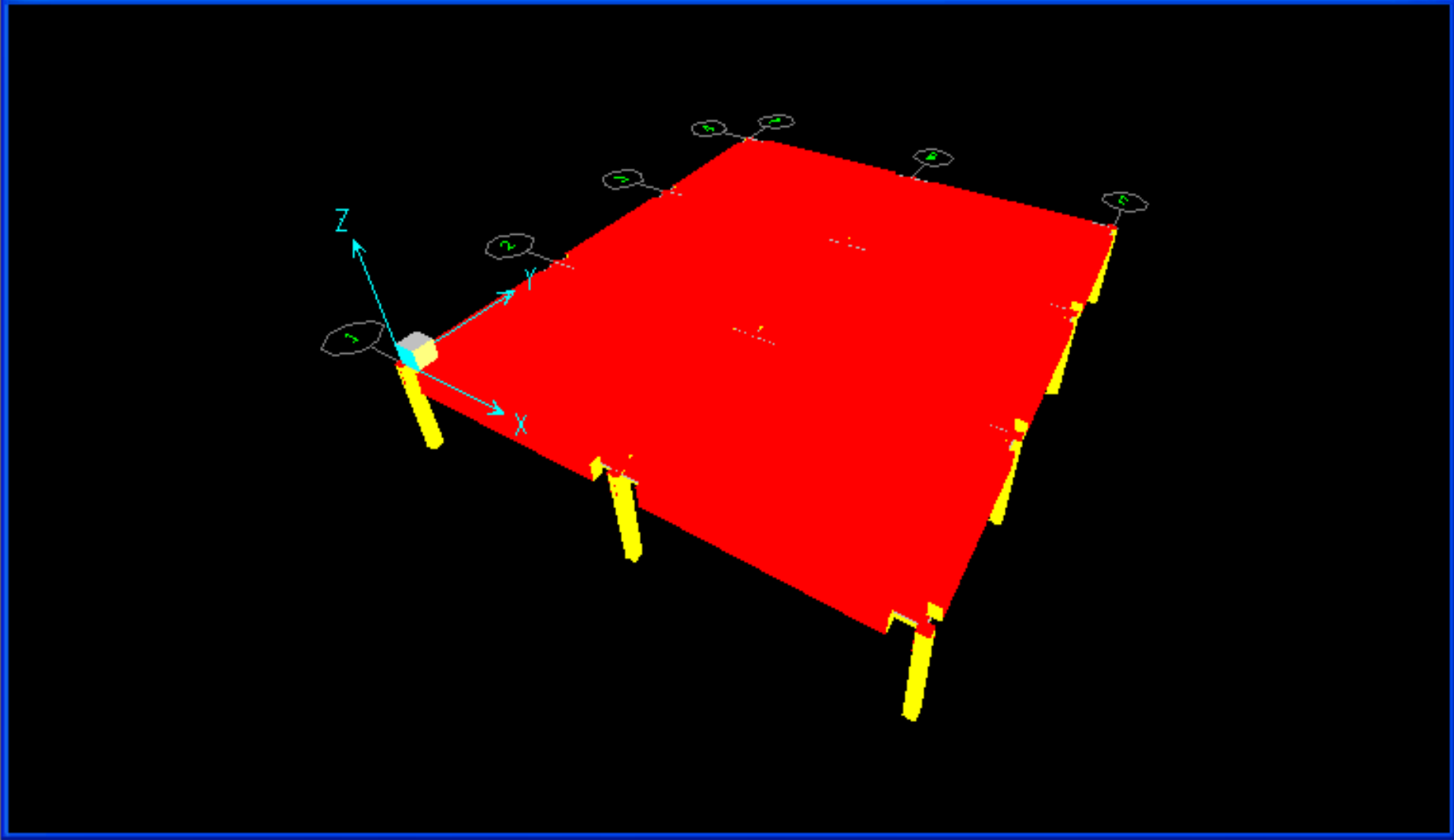

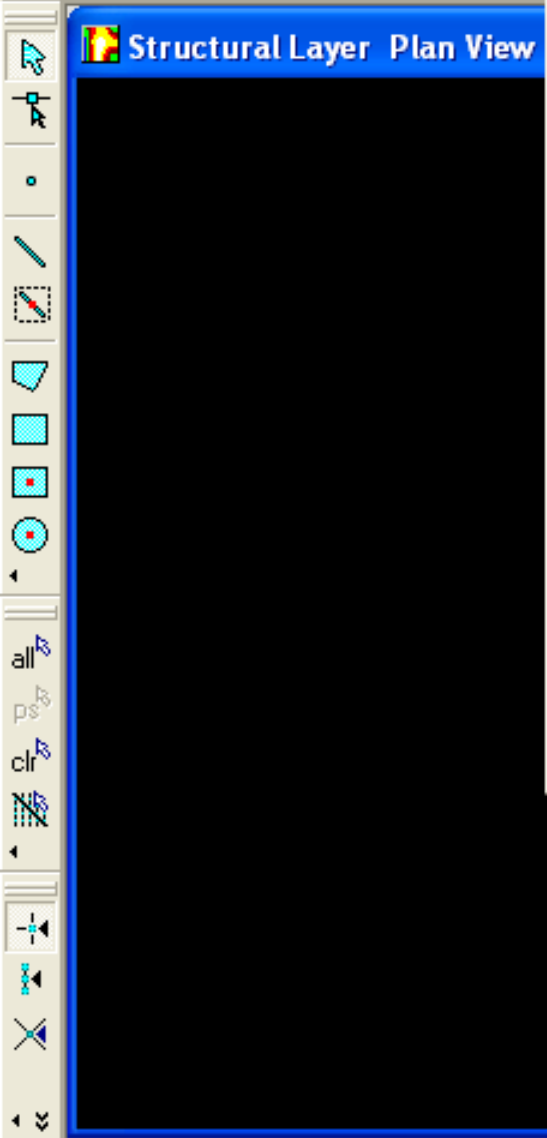
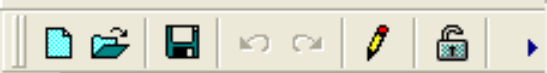

- Slab Properties...
- Slab Offset...
- Slab Rib Locations...
- Beam Properties...
- Beam Offset...
- Opening
- Point Restraints...
- Column Supports...
- Wall Supports...
- Soil Supports...
- Releases...
- Point Loads...
- Point Displacements...
- Line Loads...
- Surface Loads...**
- Group Names...
- Clear Display of Assigns

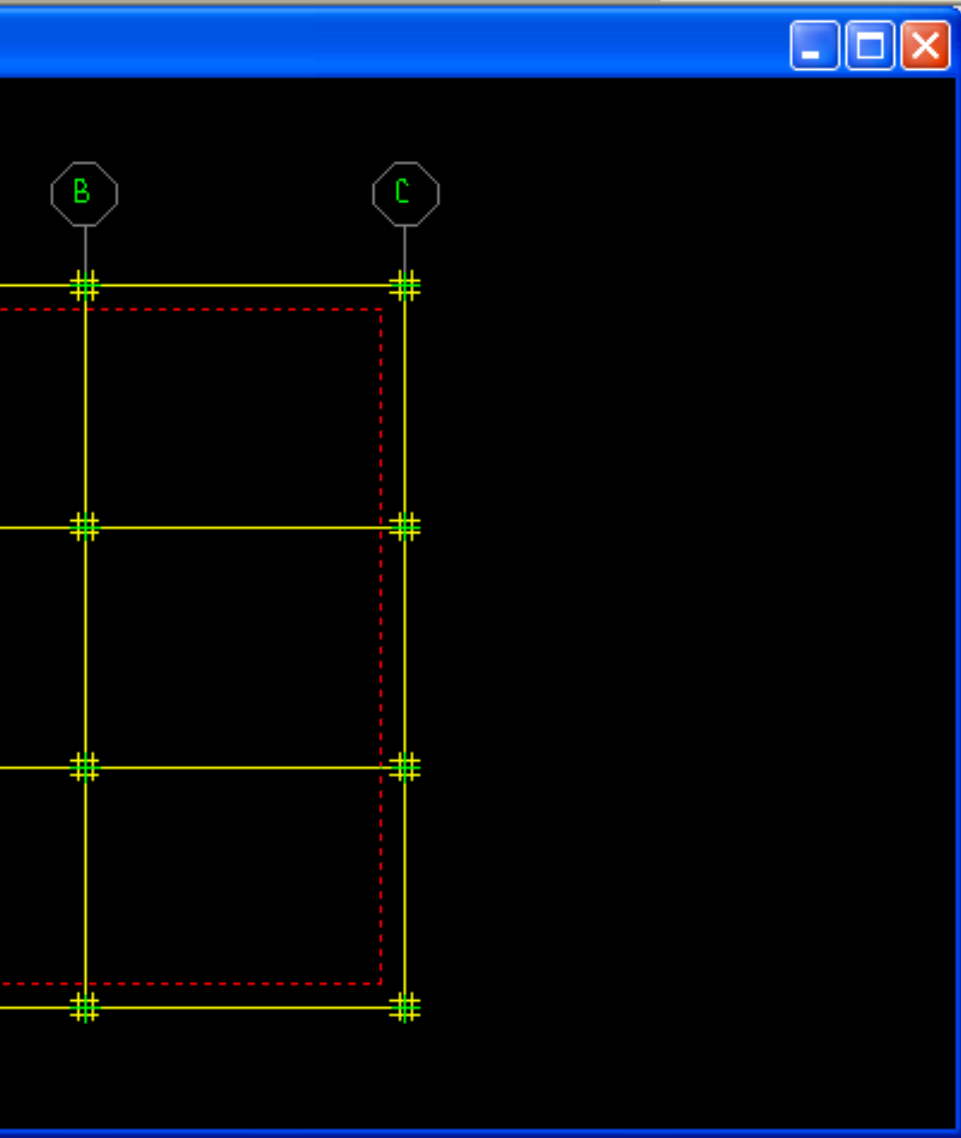

1 Areas selected

-3.620 , 69.524

Kip-ft

### Surface Loads

**Load Case Name** DEAD

**Units** Kip-ft

**Loads**  
Load per Area (Down +) 0.05

**Options**

- Add to existing loads
- Replace existing loads
- Delete existing loads

OK  
Cancel

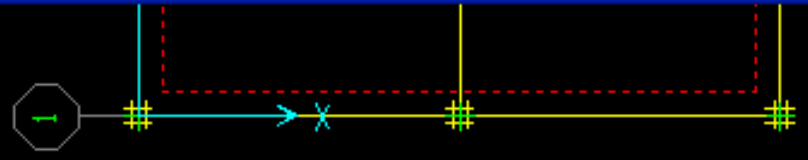



### Surface Loading (DEAD)

[Icons: Select, Move, Rotate, Zoom, Erase, Lock, Copy, Paste, Undo, Redo, Print, Save, File]

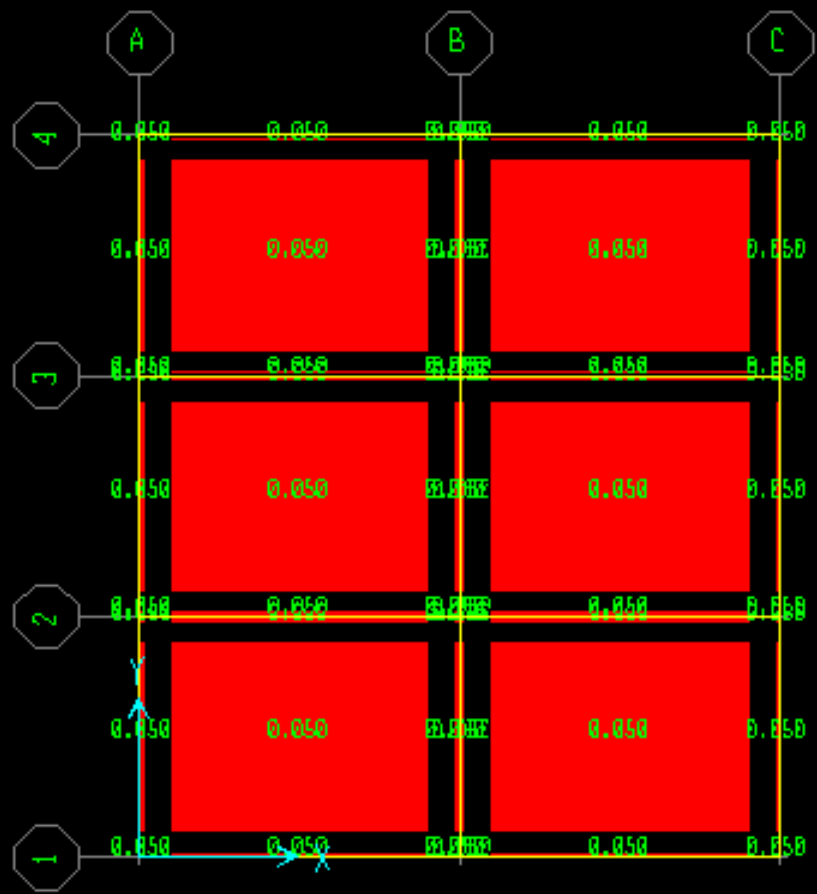

### Surface Loads

**Load Case Name** LIVE

**Units** Kip-ft

**Loads**

Load per Area (Down +) 0.06

**Options**

- Add to existing loads
- Replace existing loads
- Delete existing loads

OK

Cancel

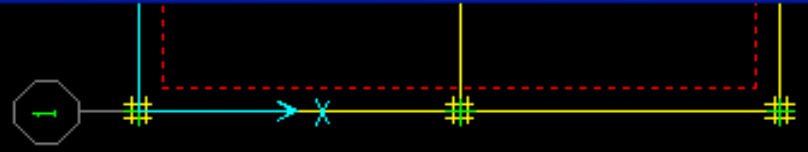

Surface Loading (LIVE) [-] [Maximize] [Close]

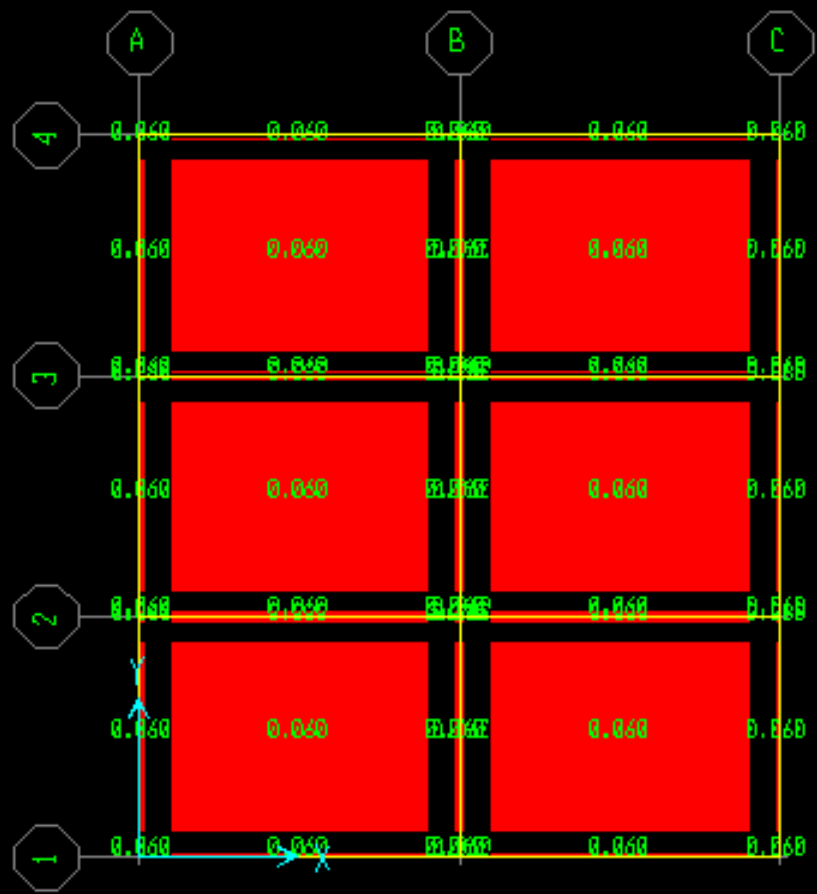

- Slab Properties...
- Beam Properties...
- Column Supports...
- Wall Supports...
- Soil Supports...
- Static Load Cases...
- Load Combinations...
- Groups...

Structu

[Tools: Selection, Drawing, Erase, Copy, Paste, Undo, Redo, etc.]

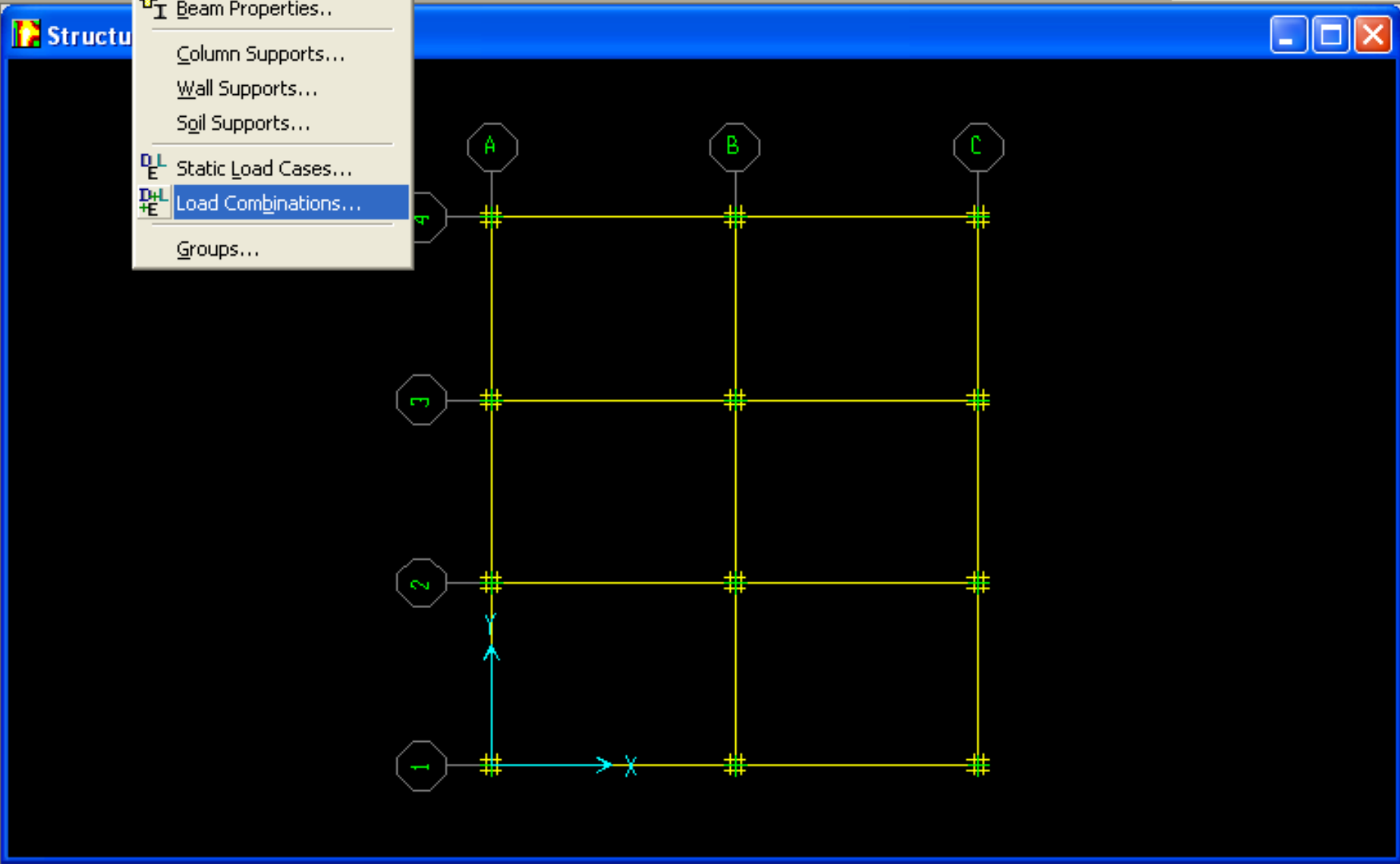

### Load Combinations

Combinations

Click to:

Add New Combo...

Modify/Show Combo...

Delete Combo

OK

Cancel

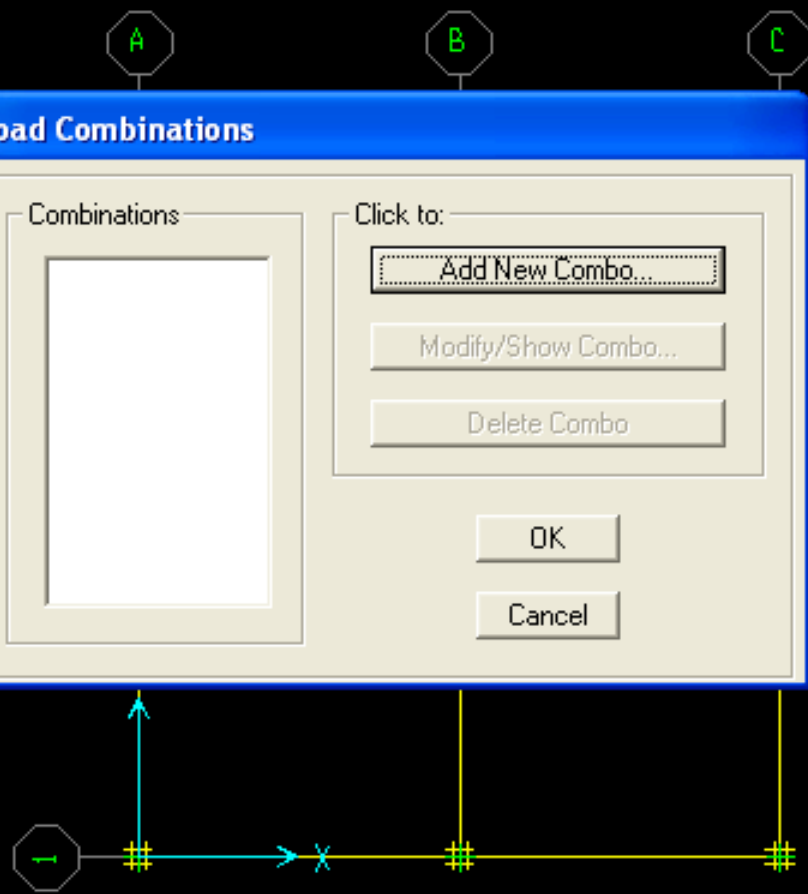

### Load Combination Data

**Load Combination Name**

**Title**

Define Combination

Case Name	Scale Factor
LIVE Load Case	1.6
DEAD Load Case	1.2
LIVE Load Case	1.6

Use for Design

Set Options...  
▶ Run Analysis F5  
Display Uplift Iteration Status

[Tools: Eraser, Line, Rectangle, Circle, etc.]

Structural Layer Plan View [-] [Maximize] [Close]

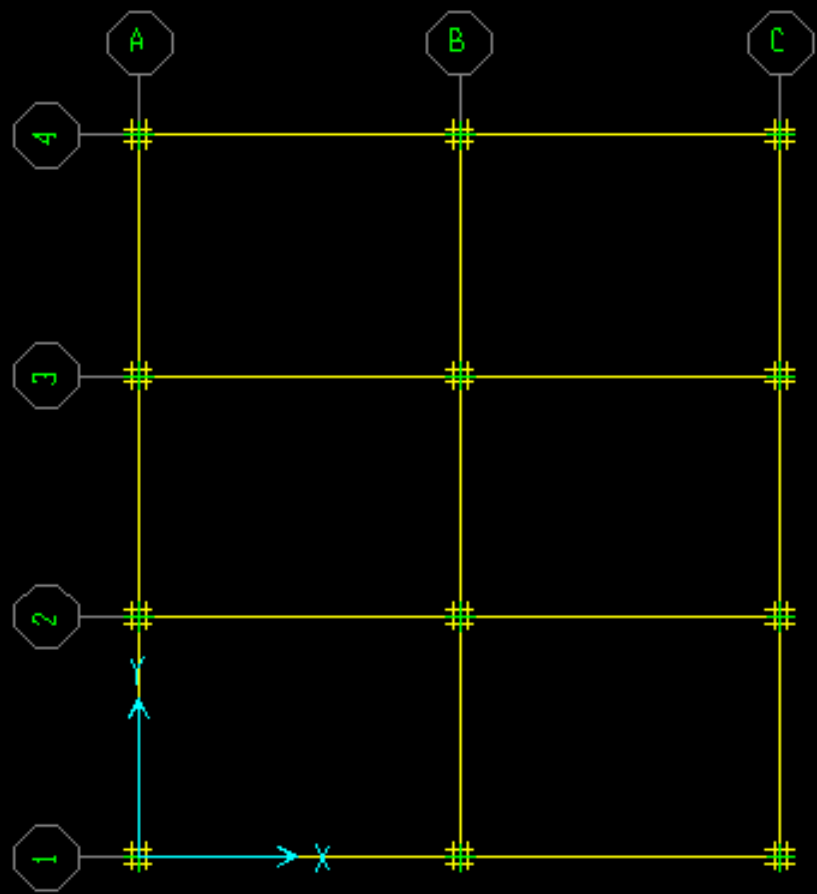

### Analysis Complete

```

NUMBER OF SPRING ELEMENTS SAVED      =          12

ELEMENT OUTPUT                        20:19:40

NUMBER OF BEAM ELEMENTS SAVED        =          135
NUMBER OF SLAB ELEMENTS SAVED        =          402

ANALYSIS COMPLETE                    2007/07/14 20:19:41

```

OK

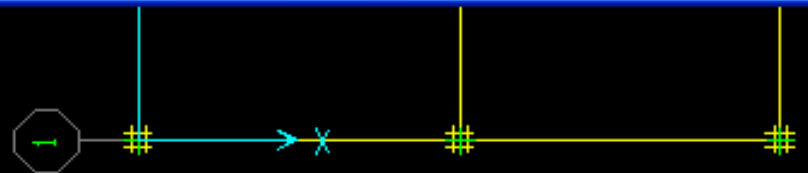





- Show Undeformed Shape F4
- Show Loads...
- Show Input Tables...
- Show Deformed Shape... F6
- Show Slab Forces...
- Show Beam Forces...
- Show Strip Forces...
- Show Reaction Forces...
- Show Output Tables... Shift+F12

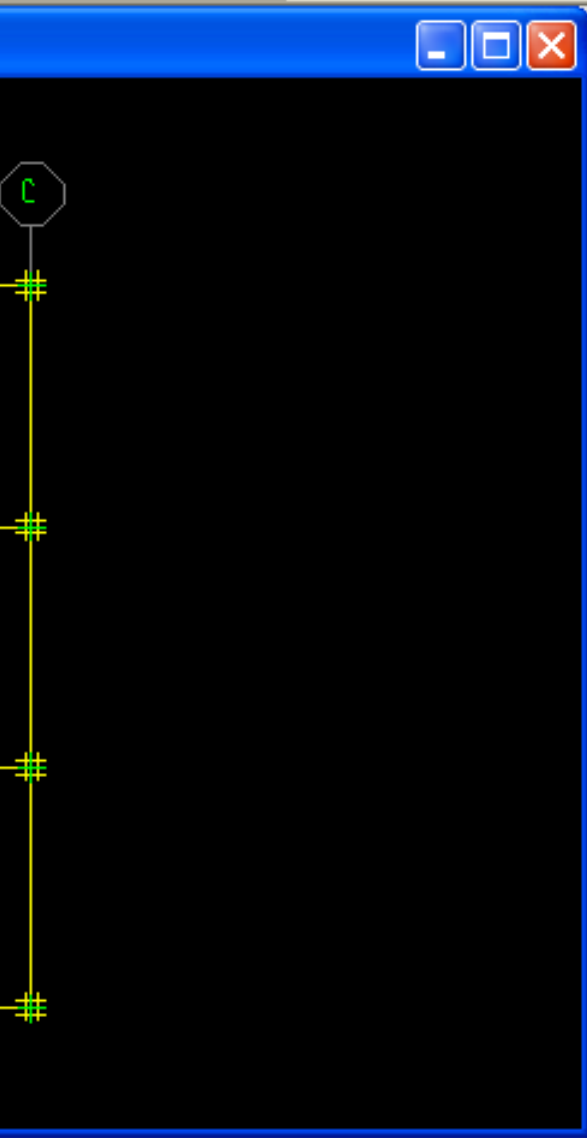
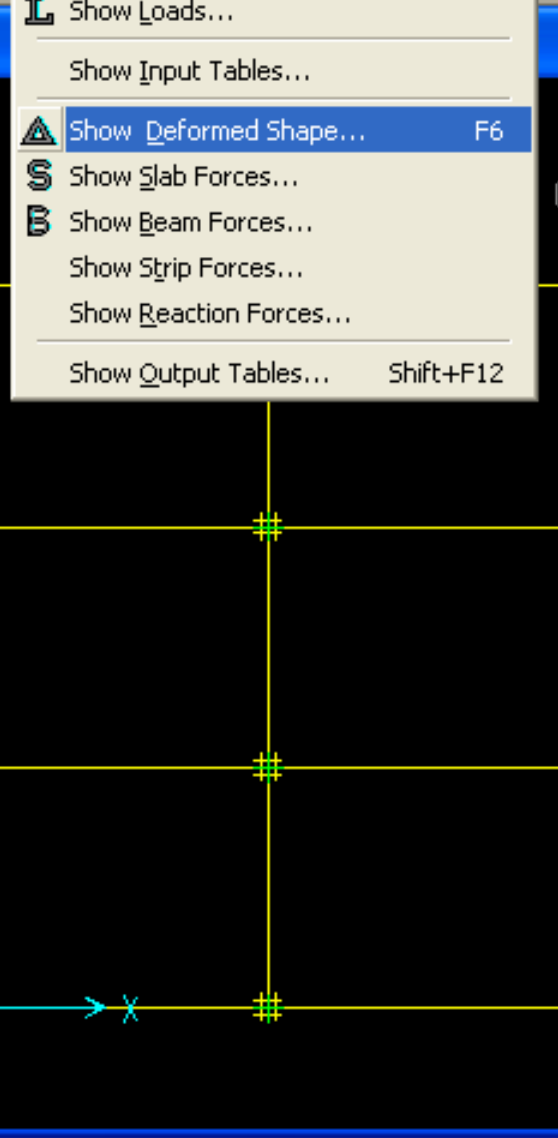
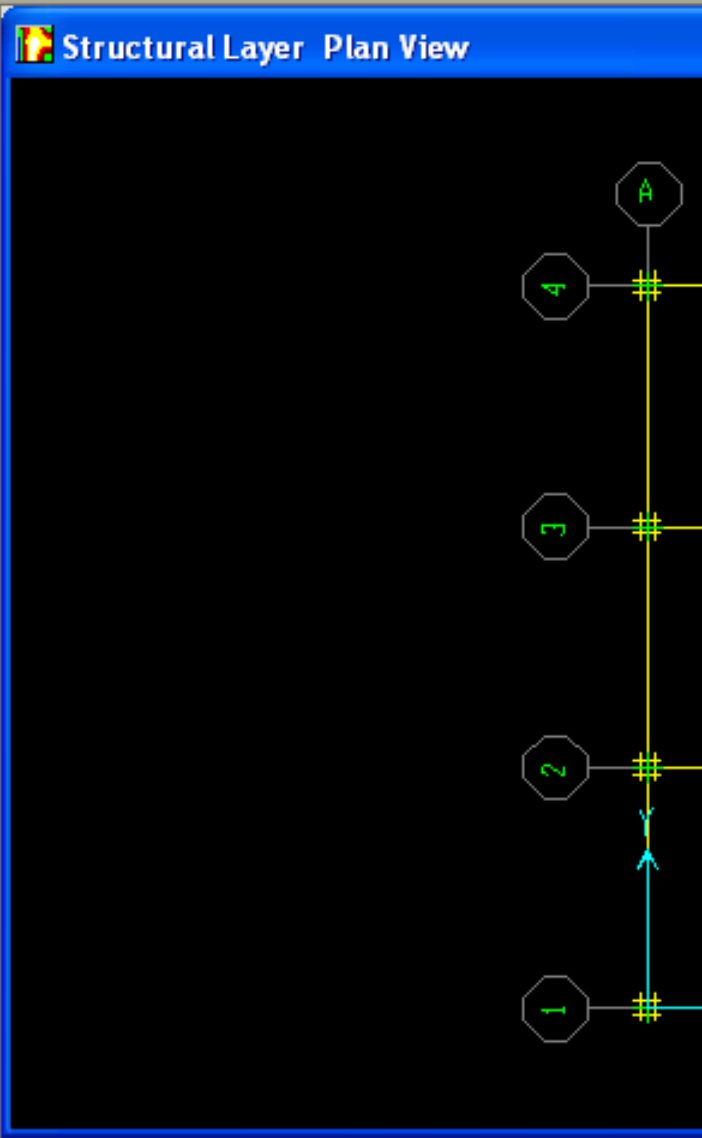

### Deformed Shape

**Load** DEAD Load Case  
DEAD Load Case  
LIVE Load Case  
COMB1 Combo

**Scaling**  
 Auto  
 Scale Factor

**Display Options**  
 Displacement Contours  
 Elastic  
 Long Term Cracked

**Contour Range**  
Min 0. Max 0.

OK Cancel

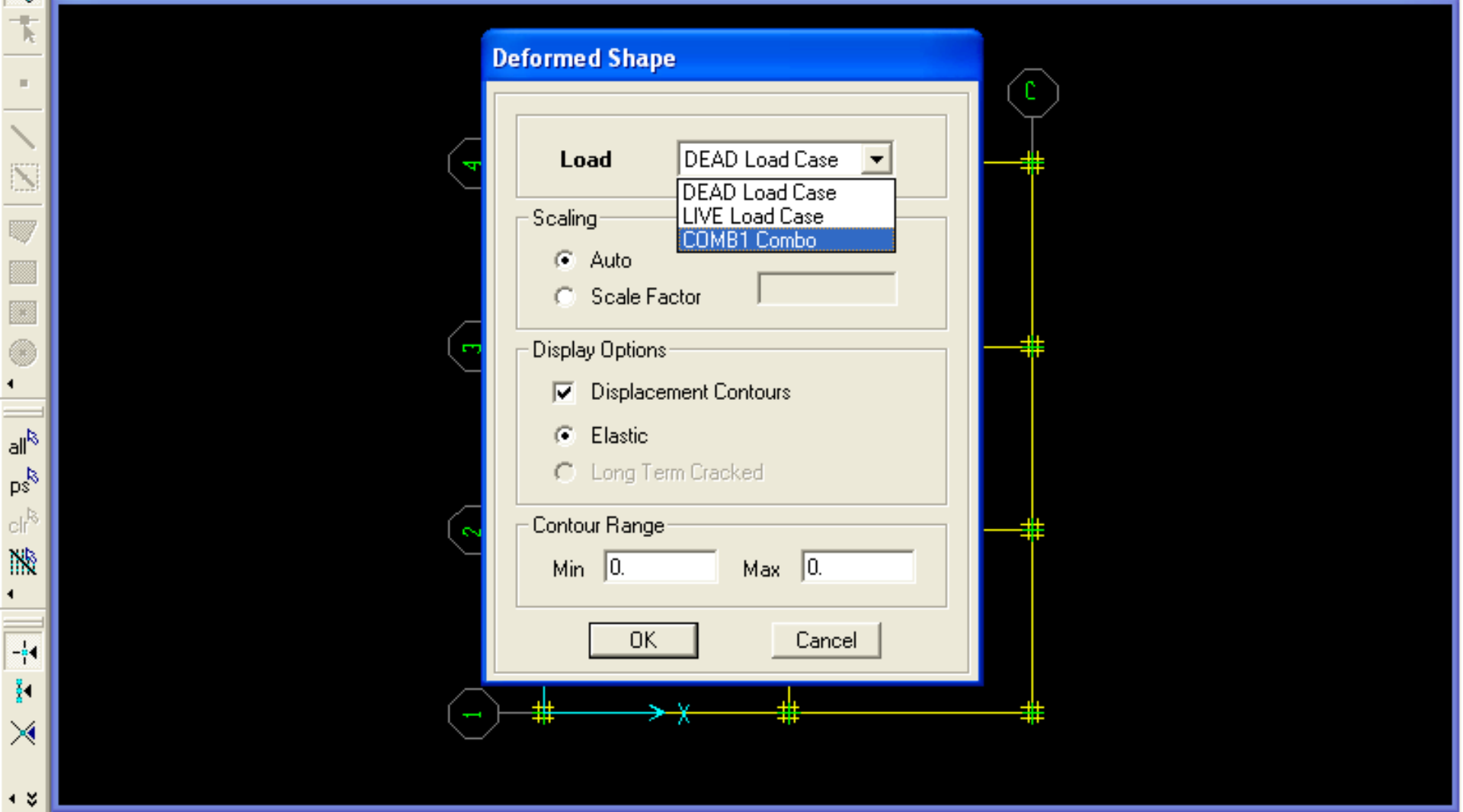

Elastic Deformed Shape (COMB1) [-] [Maximize] [Close]

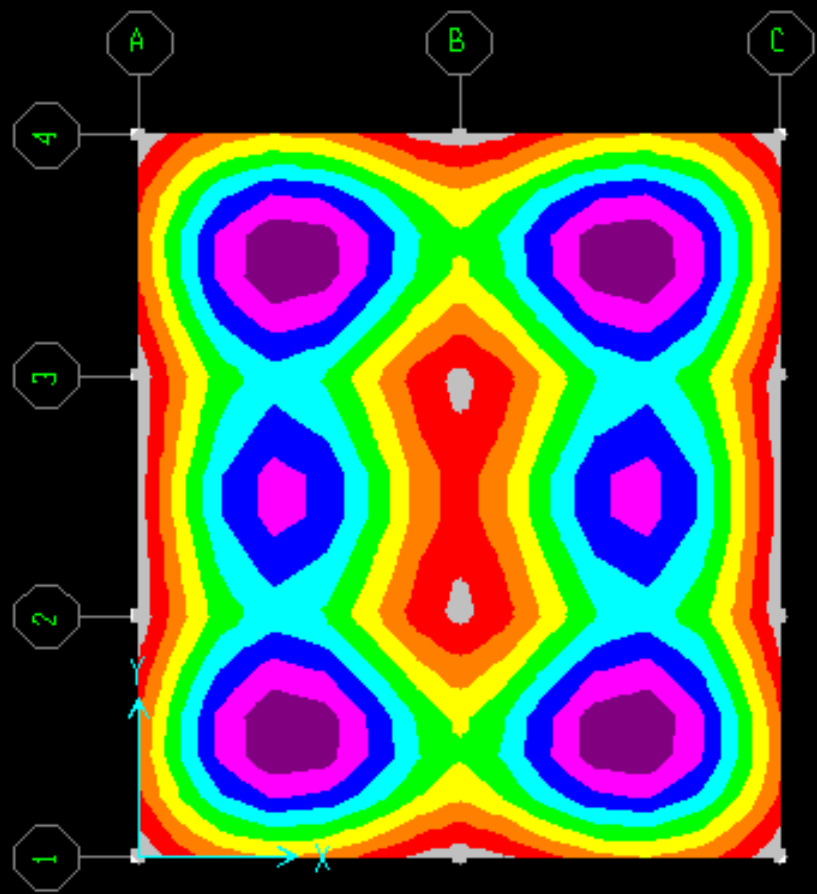

Move cursor over slab elements for displacement values

452.145 , 700.694

Kip-in [Dropdown]



- Show Undeformed Shape F4
- Show Loads...
- Show Input Tables...
- Show Deformed Shape... F6
- Show Slab Forces... (highlighted)
- Show Beam Forces...
- Show Strip Forces...
- Show Reaction Forces...
- Show Output Tables... Shift+F12

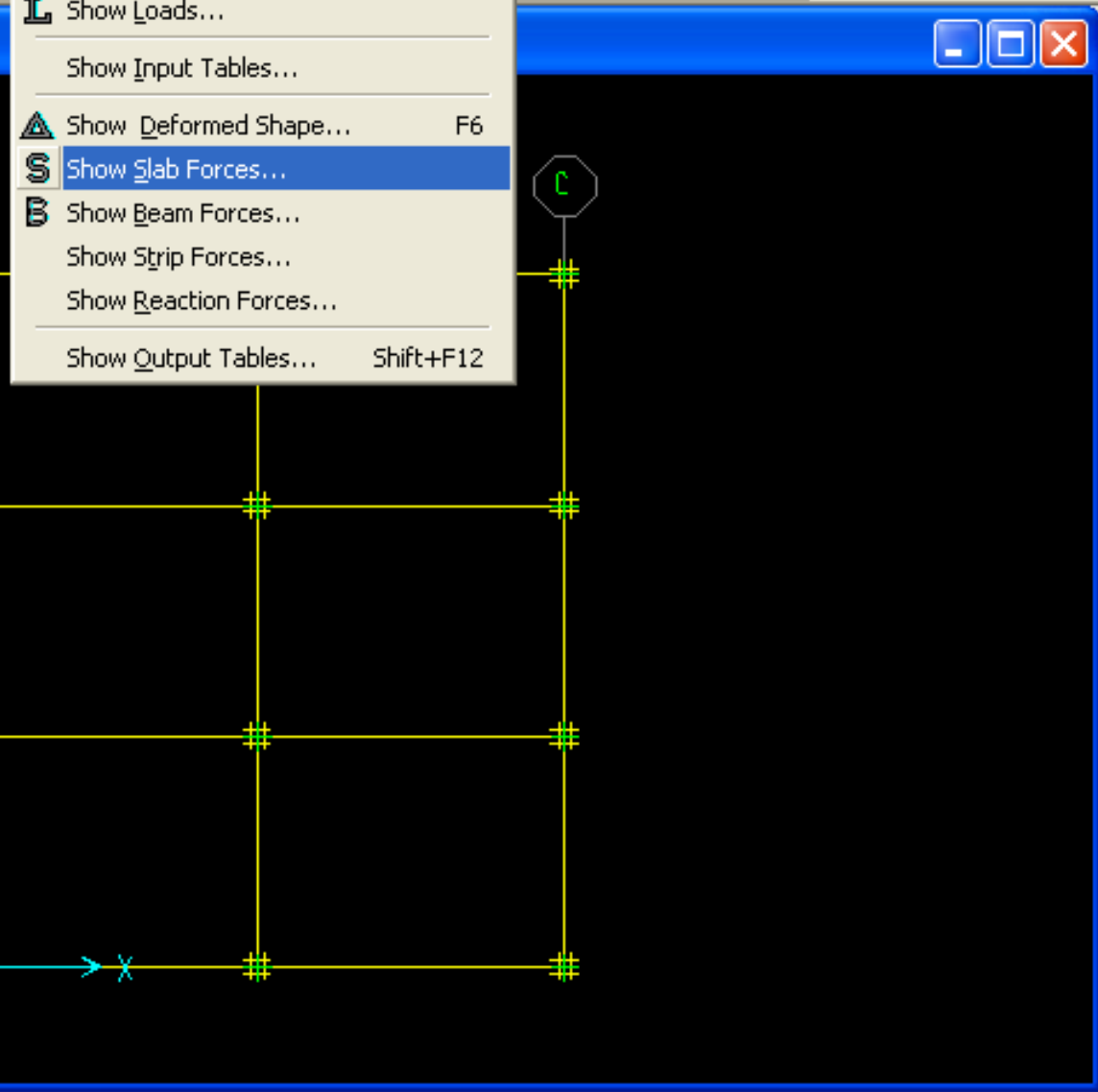
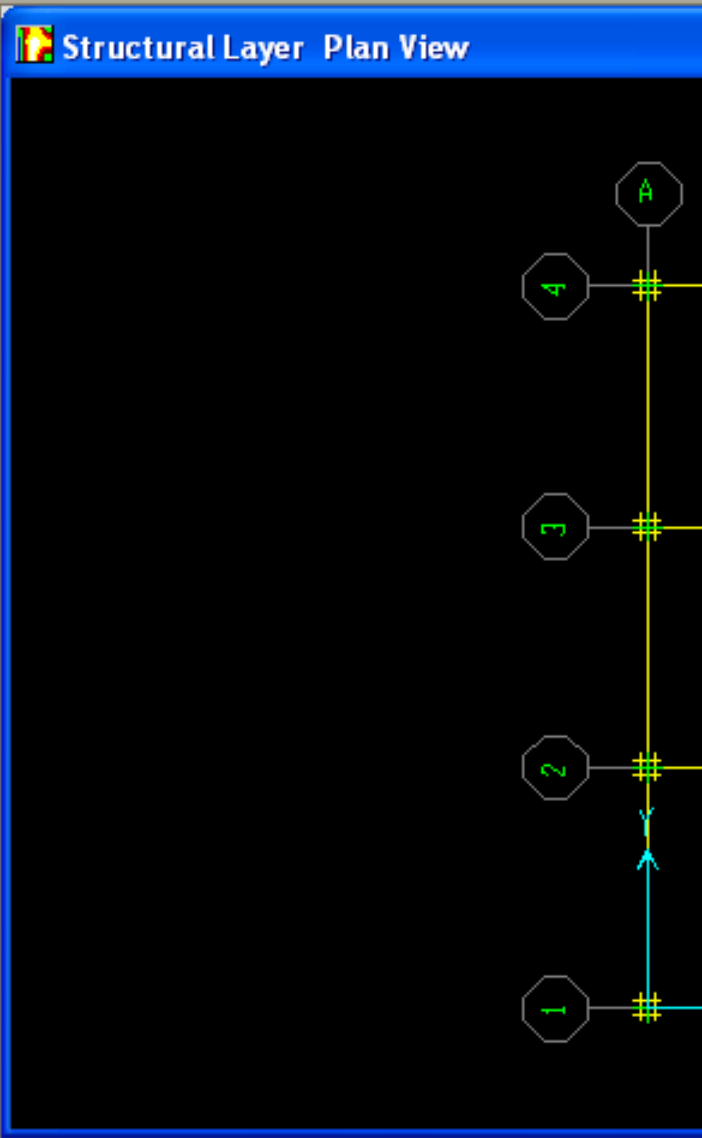

### Slab Forces

Load **COMB1 Combo**

- Component
- Mxx
  - Myy
  - Mxy
  - Vxx
  - Vyy
  - Mmax
  - Mmin
  - Vmax

- Display Options
- Extrude Contours
  - Display Contours on Deformed Shape

- Scaling
- Auto
  - Scale Factor

- Contour Averaging
- None
  - at All Joints
  - at Selected Joints

Contour Range

Min  Max

OK Cancel

Slab Resultant Mxx Diagram - (COMB1)

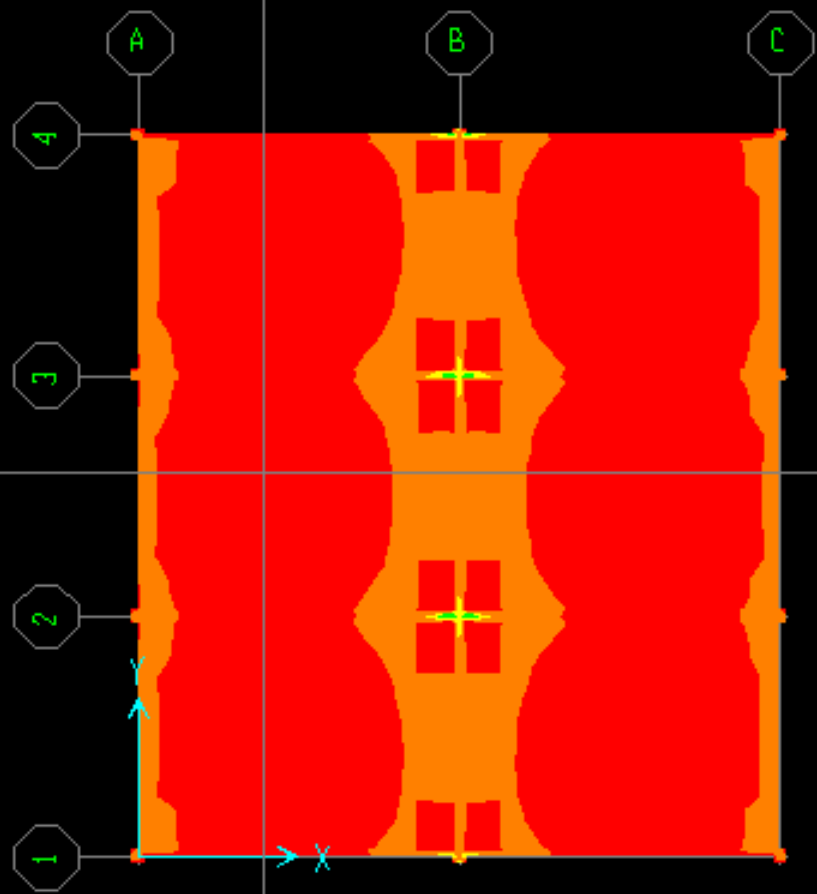

-720. -600. -480. -360. -240. -120. 0. 120. 240.

Value is 2.936 Max 303.019 at [23.500,18.500] Min -773.097 at [23.500,18.000]

9.308 , 28.764

Kip-ft

**Load** COMB1 Combo

**Component**

Mxx  Myy  Mxy

Vxx  Vyy

Mmax  Mmin  Vmax

**Display Options**

Extrude Contours

Display Contours on Deformed Shape

**Scaling**

Auto

Scale Factor

**Contour Averaging**

None

at All Joints

at Selected Joints

**Contour Range**

Min 0. Max 0.

OK Cancel

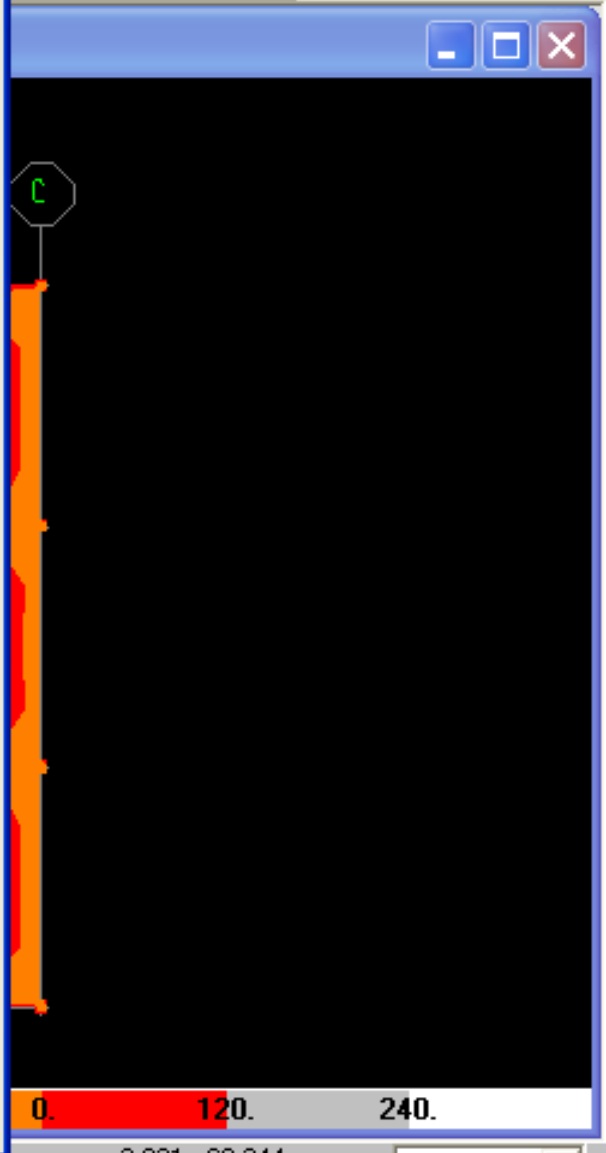
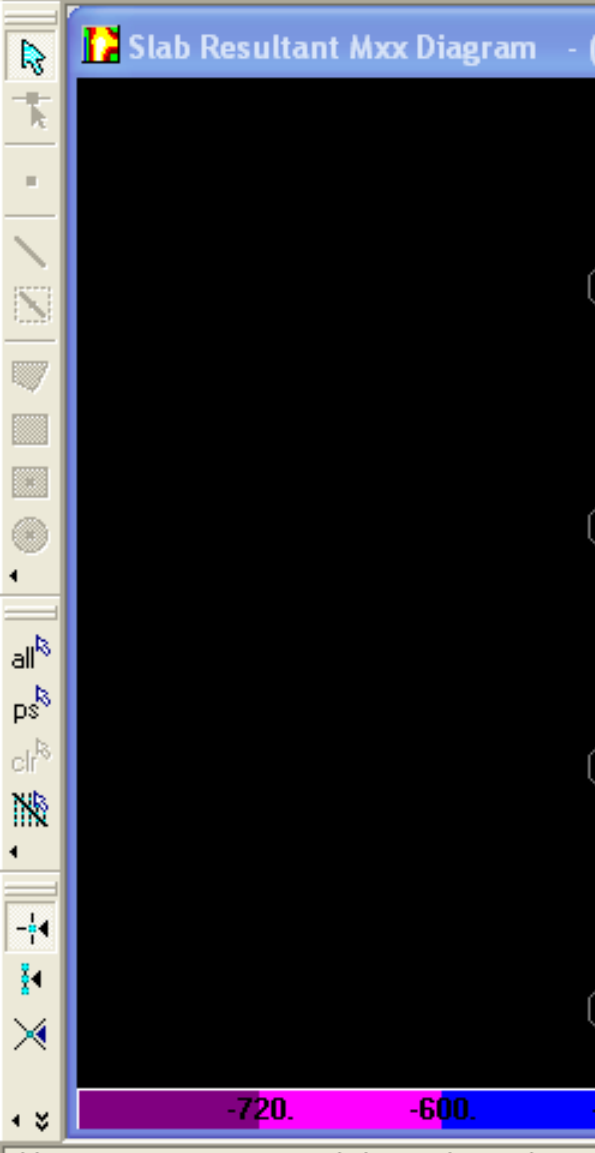

Slab Resultant My Diagram - (COMB1)

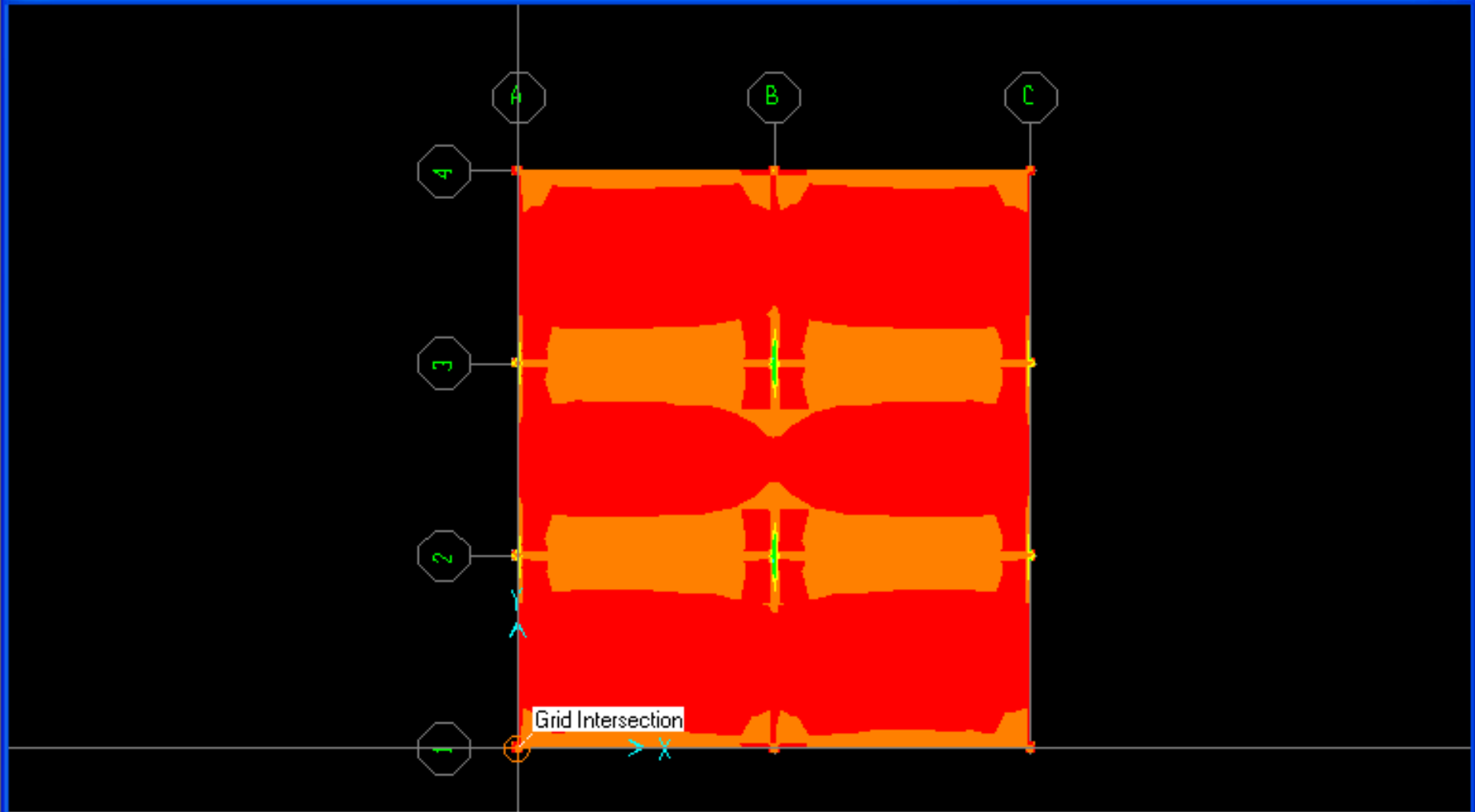

Value is -5.680 Max 105.372 at [23.500,0.000] Min -273.591 at [24.000,17.500] 0.000 , 0.000 Kip-ft





- Show Undeformed Shape F4
- Show Loads...
- Show Input Tables...
- Show Deformed Shape... F6
- Show Slab Forces...
- Show Beam Forces...
- Show Strip Forces...
- Show Reaction Forces...
- Show Output Tables... Shift+F12

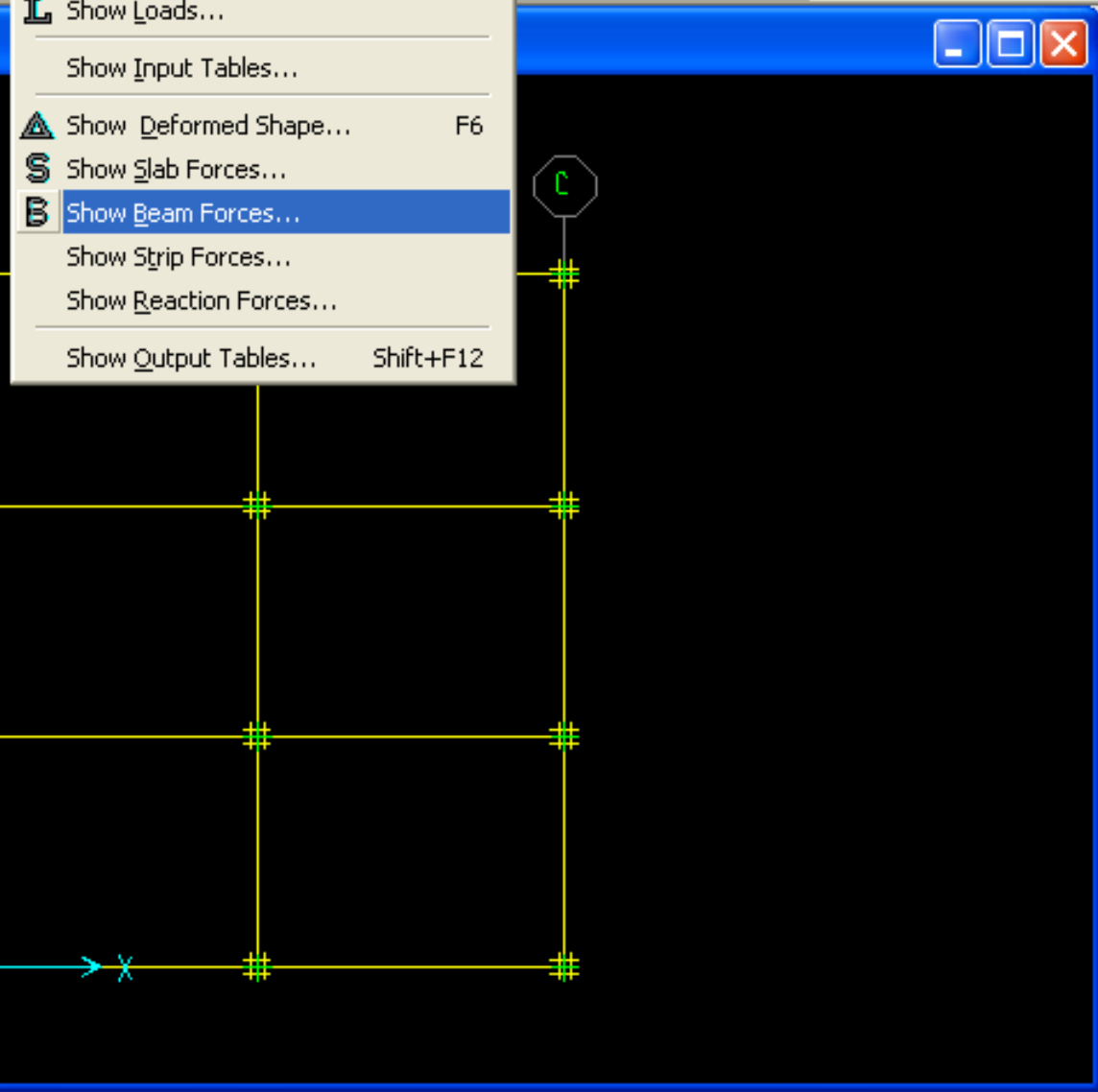
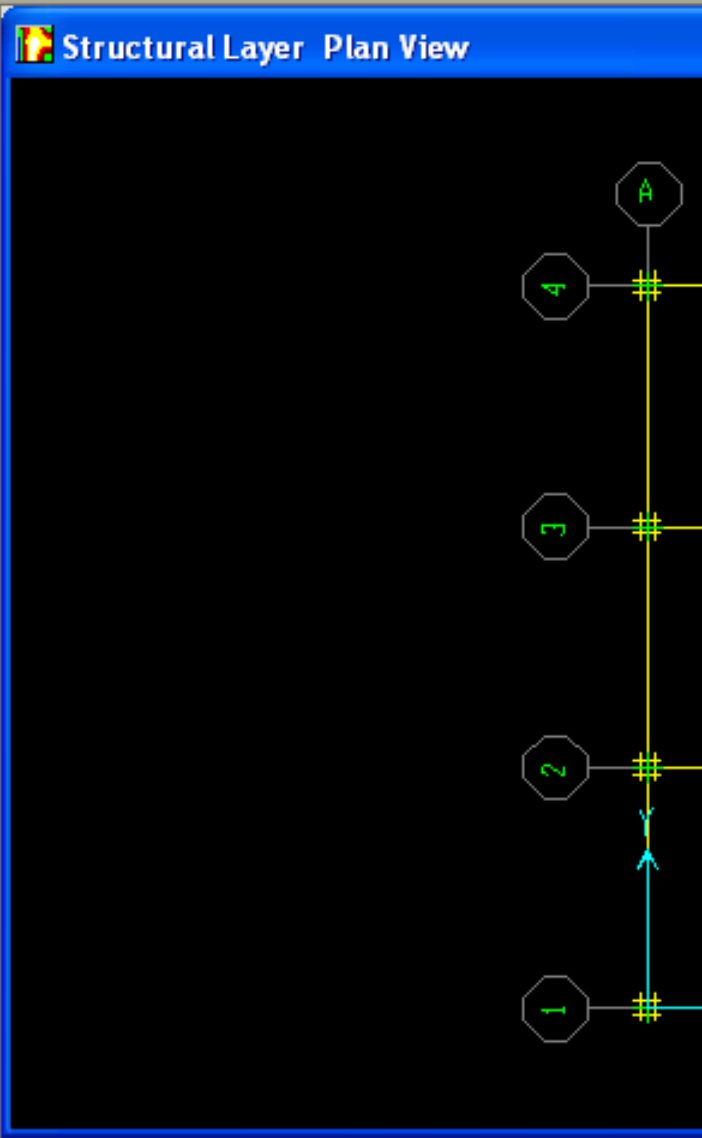

### Beam Forces

**Load** COMB1 Combo

**Component**  
 Moment  Shear  Torsion

**Scaling**  
 Auto  Scale Factor

**Display Options**  
 Fill Diagram  Show Values on Diagram

OK Cancel

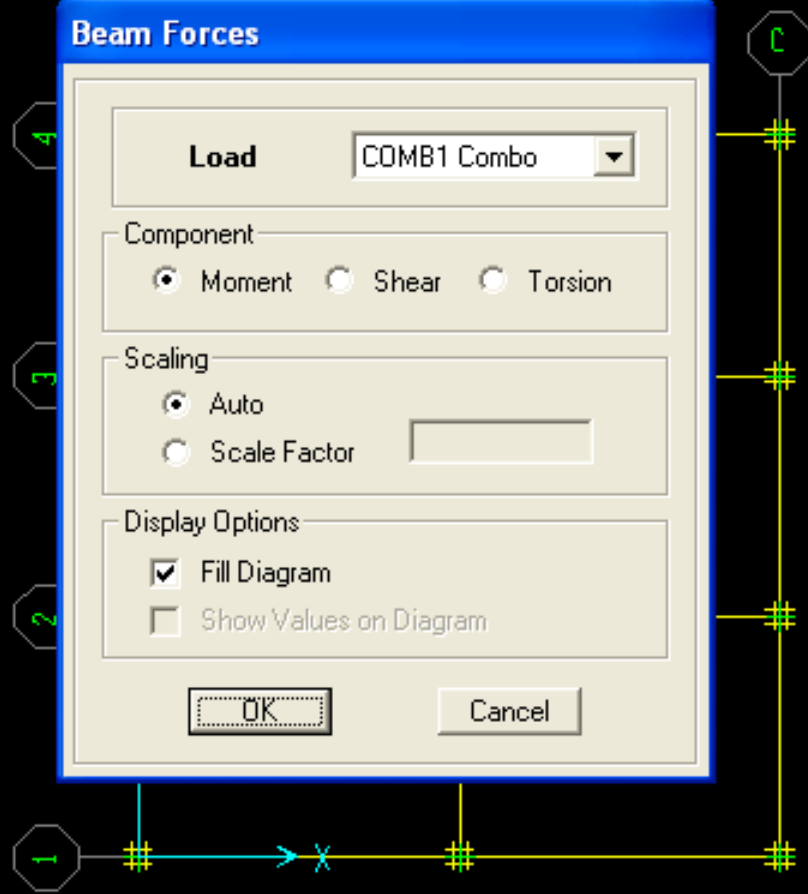

Beam Moment Diagram - (COMB1)

[Vertical toolbar with icons for selection, drawing, and analysis]

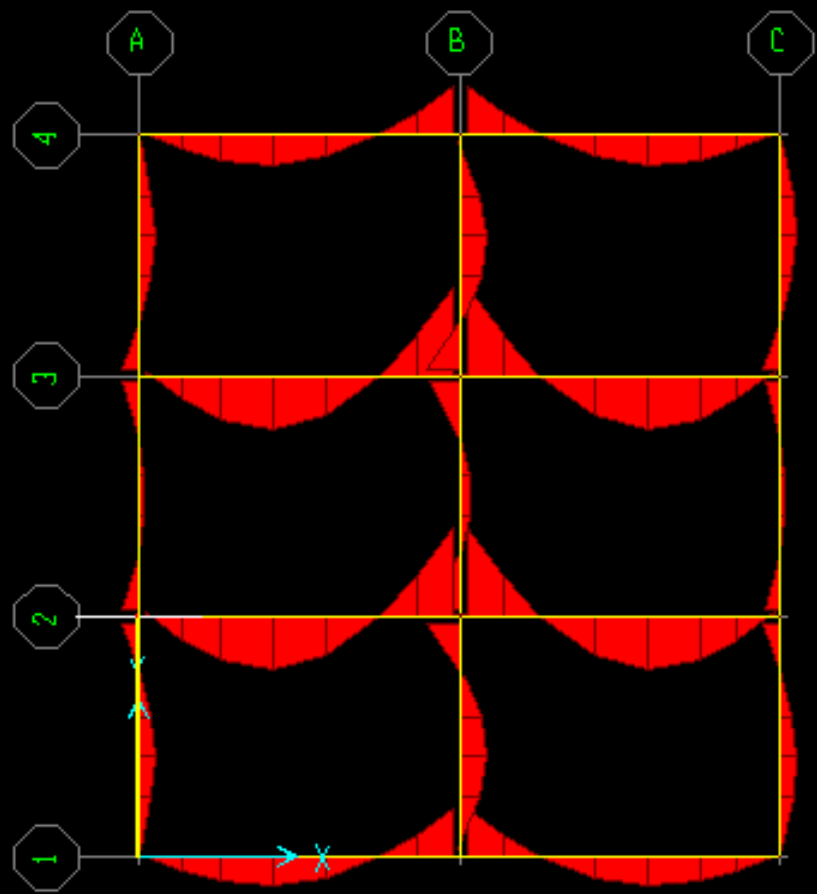

BEAM 11 Value is -0.314 at 18.000 Max 132.608 at [10.000,36.000] Min -222.106 at [23.500,36.000]

7.512 , 26.788

Kip-ft



- Show Undeformed Shape F4
- Show Loads...
- Show Input Tables...
- Show Deformed Shape... F6
- Show Slab Forces...
- Show Beam Forces...
- Show Strip Forces...
- Show Reaction Forces...
- Show Output Tables... Shift+F12

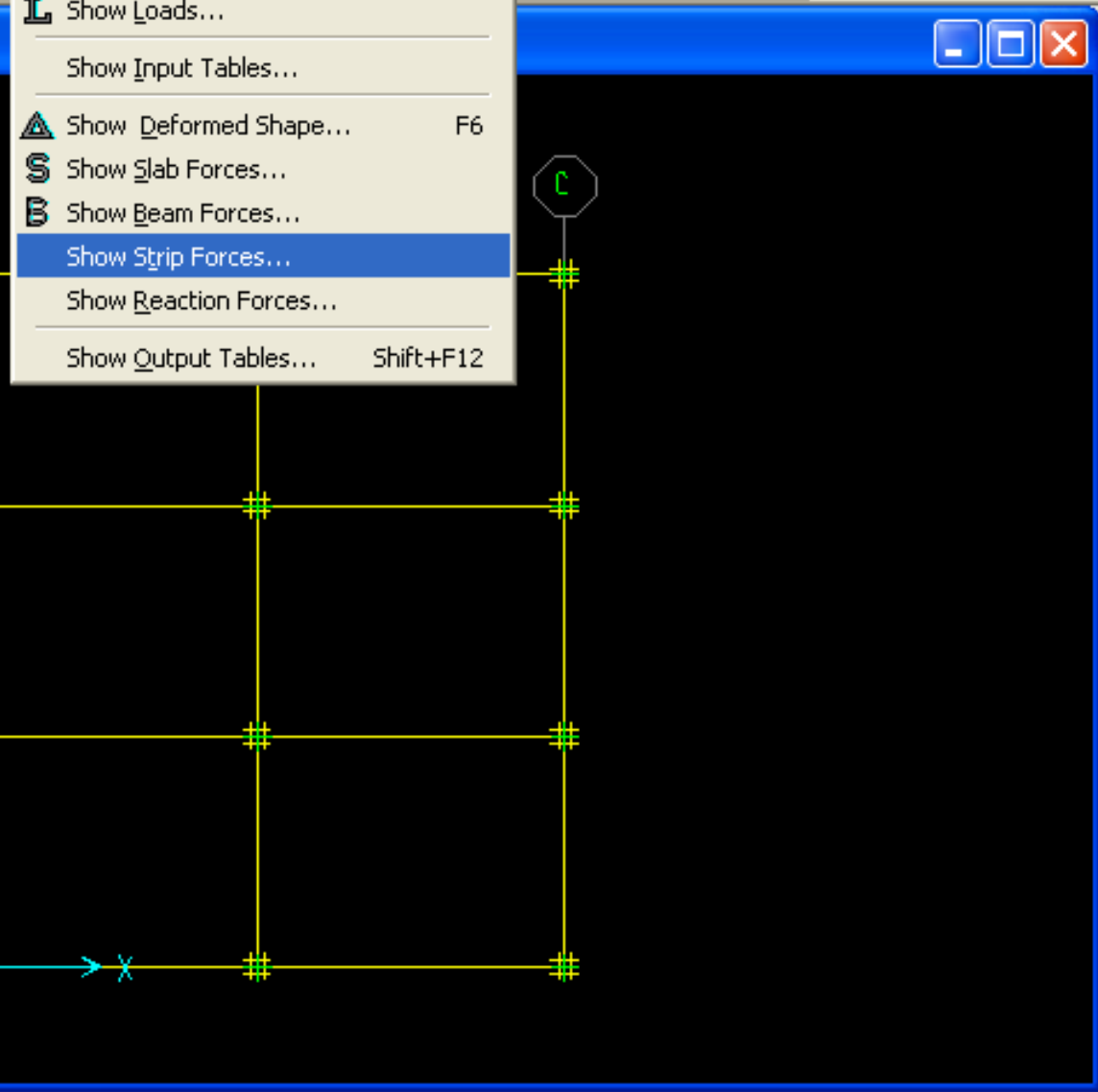
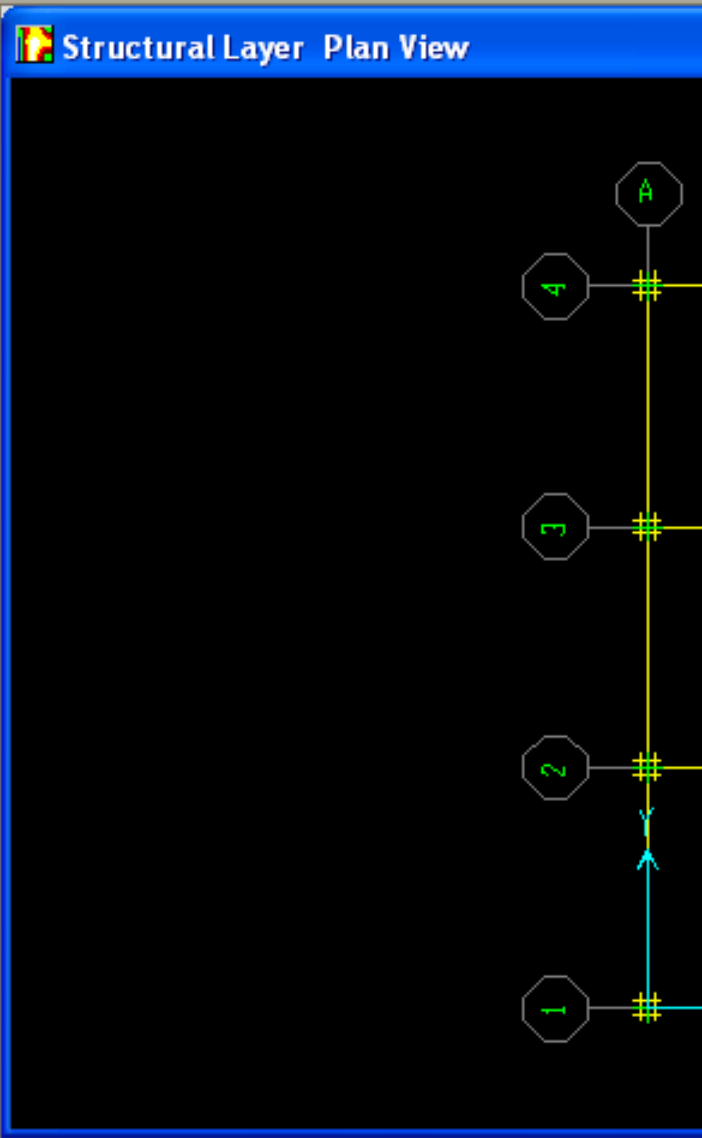

### Strip Forces

**Load** COMB1 Combo

**Component**

X-Strip Moments     Y-Strip Moments  
 X-Strip Shears     Y-Strip Shears

**Scaling**

Auto     Scale Factor

**Display Options**

Fill Diagram  
 Show Values on Diagram

OK    Cancel

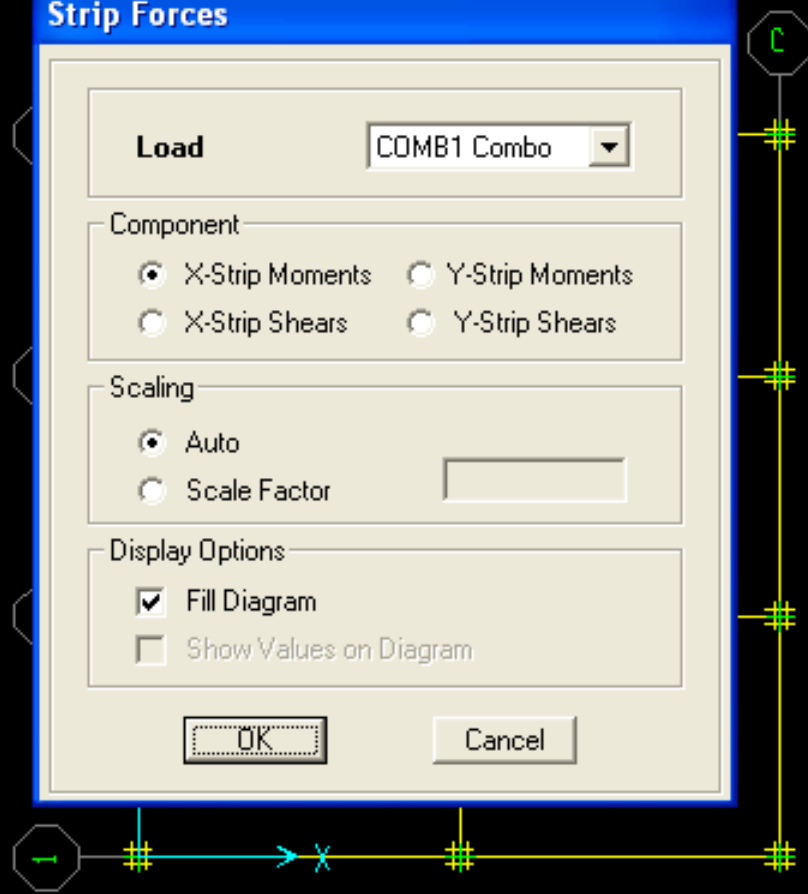

X-Strip Moment Diagram - (COMB1)

[Vertical toolbar with various icons for navigation and editing]

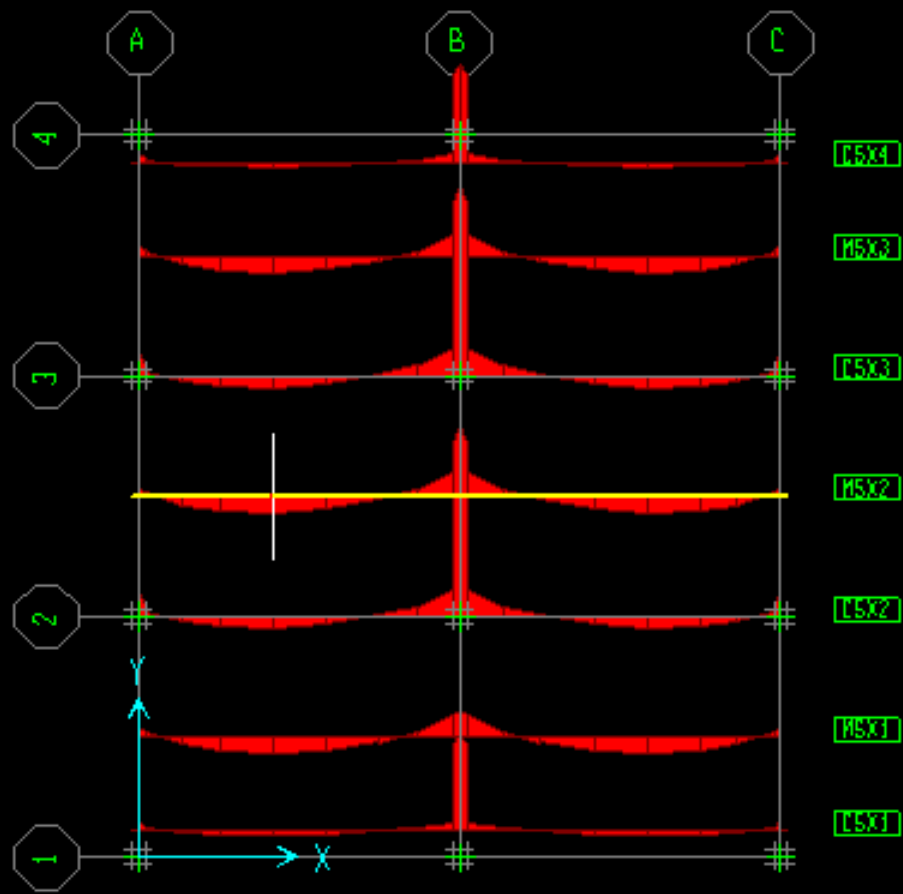

STRIP MSX2 Value is 311.205 at X=120.316 Max 311.668 at [120.000,324.000] Min -3428.222 at

120.316 , 308.531

Kip-in

### Strip Forces

**Load** COMB1 Combo

**Component**

X-Strip Moments  Y-Strip Moments

X-Strip Shears  Y-Strip Shears

**Scaling**

Auto

Scale Factor

**Display Options**

Fill Diagram

Show Values on Diagram

OK Cancel

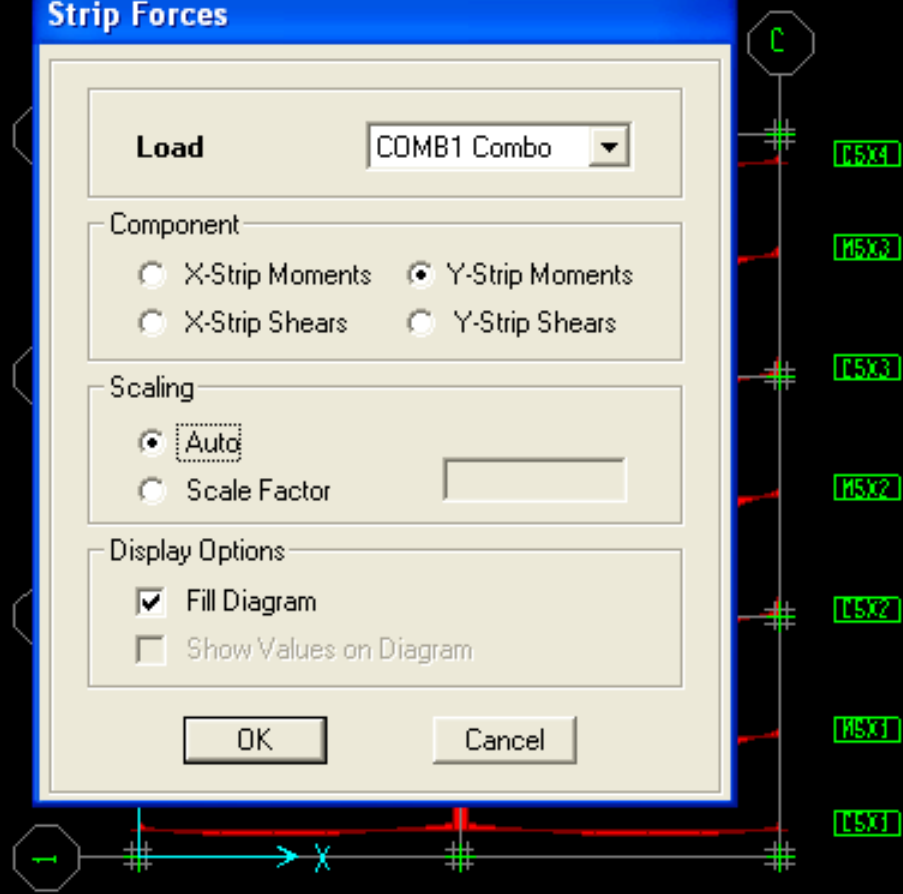

Y-Strip Moment Diagram - (COMB1)

[Vertical toolbar with various icons for navigation and editing]

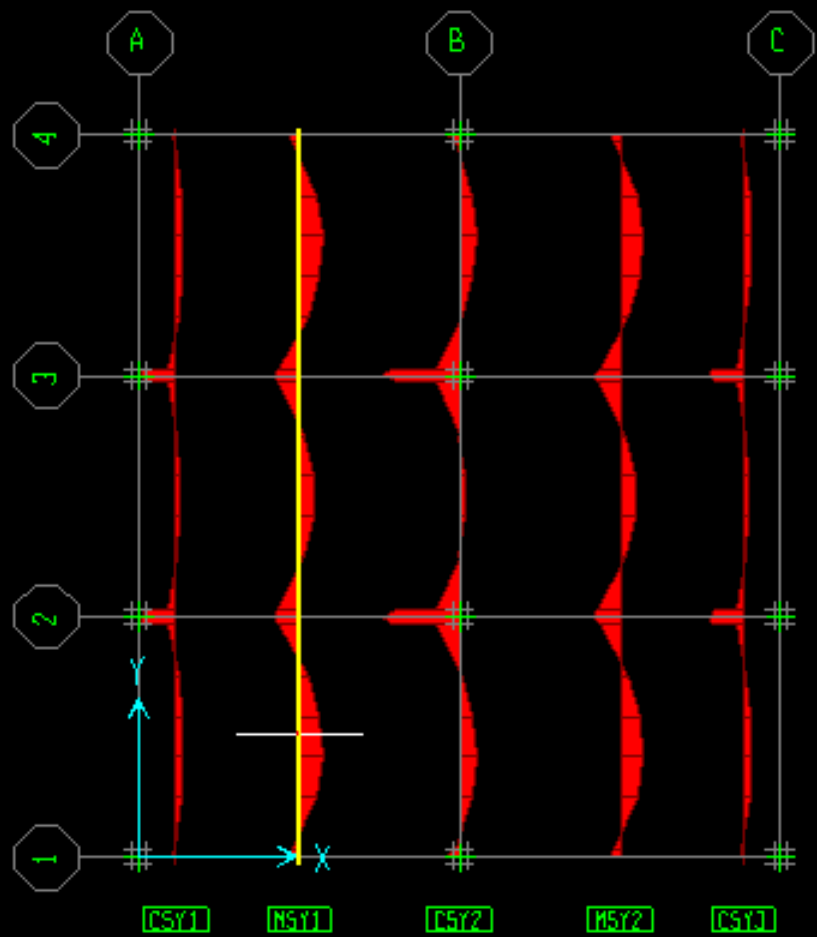

STRIP MSY1 Value is 484.414 at Y=110.295 Max 520.939 at [144.000,54.000] Min -1791.812 at

135.399 , 110.295

Kip-in





- Start Design
- Select Design Combos... Ctrl+F6
- Display Slab Design Info... Ctrl+F8
- Display Beam Design Info...
- Display Punching Shear Ratios
- Show Design Tables...
- Show Total Quantities...



Structural Layer Plan View

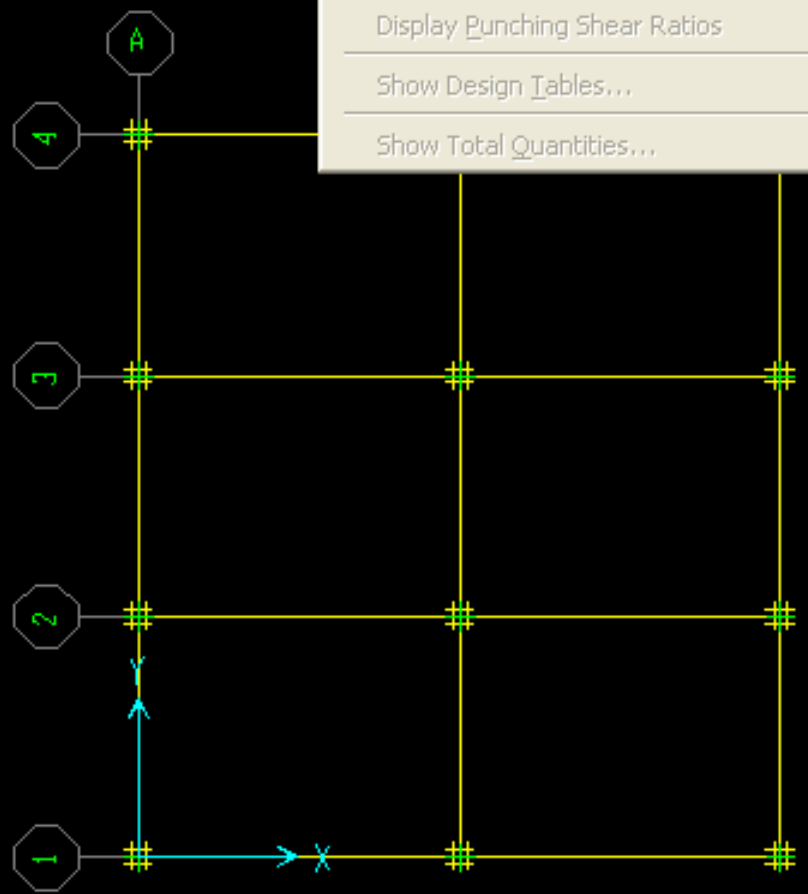

### Design Load Combinations Selection

Choose Combos

List of Combos	Design Combos
	COMB1

Add ->  
<- Remove  
Show

OK Cancel

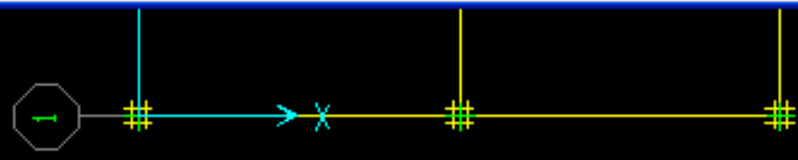



Start Design

Select Design Combos... Ctrl+F6

Display Slab Design Info... Ctrl+F8

Display Beam Design Info...

Display Punching Shear Ratios

Show Design Tables...

Show Total Quantities...

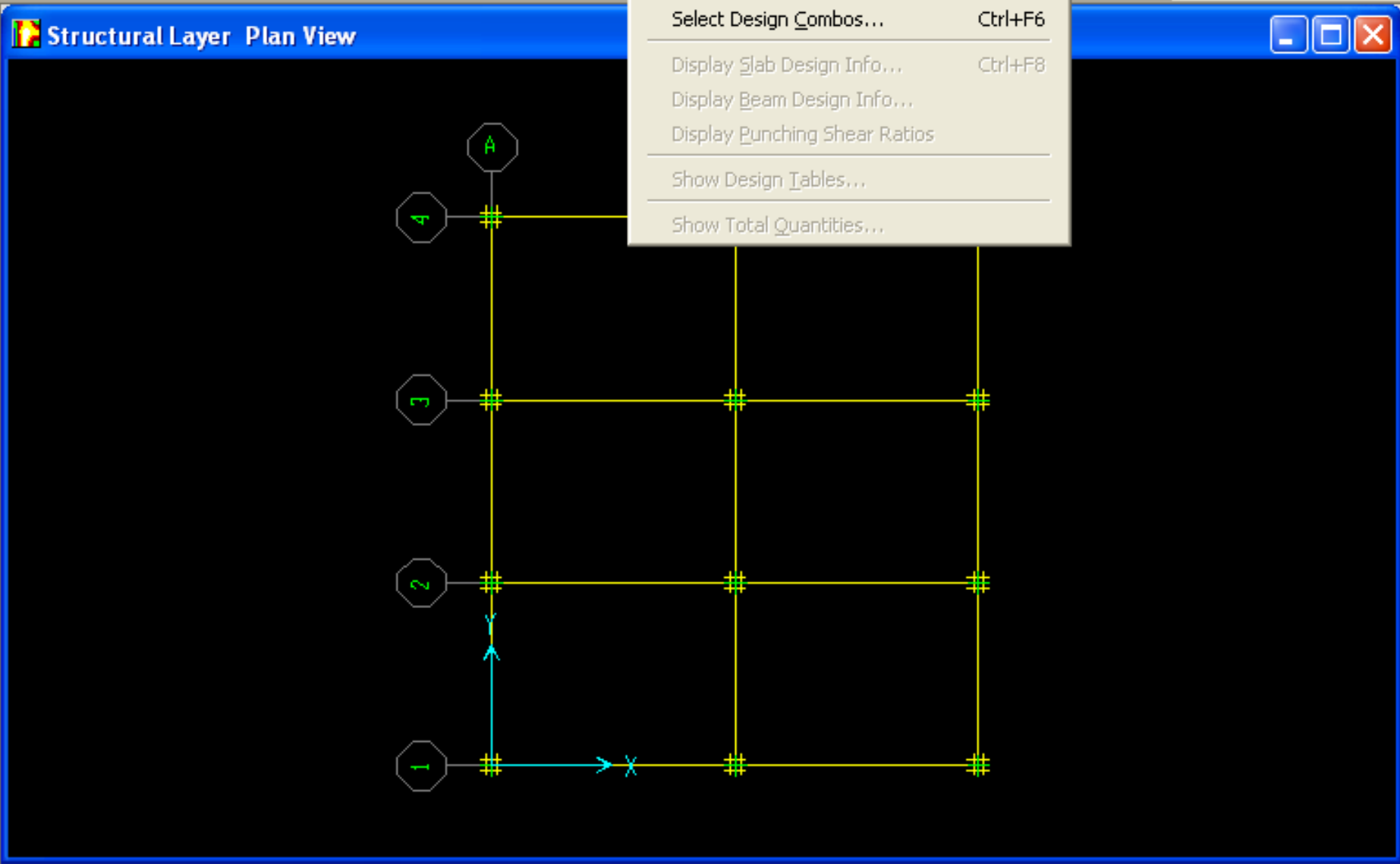

### X-Strip Reinforcement (Sq-in)

[-] [Maximize] [Close]

[Icons: Select, Move, Rotate, Zoom, 3-d xy, Units, View, Print, Close]

[Icons: All, Pos, Clr]

[Icons: Zoom, Rotate, Move]

[Icons: Zoom, Rotate, Move]

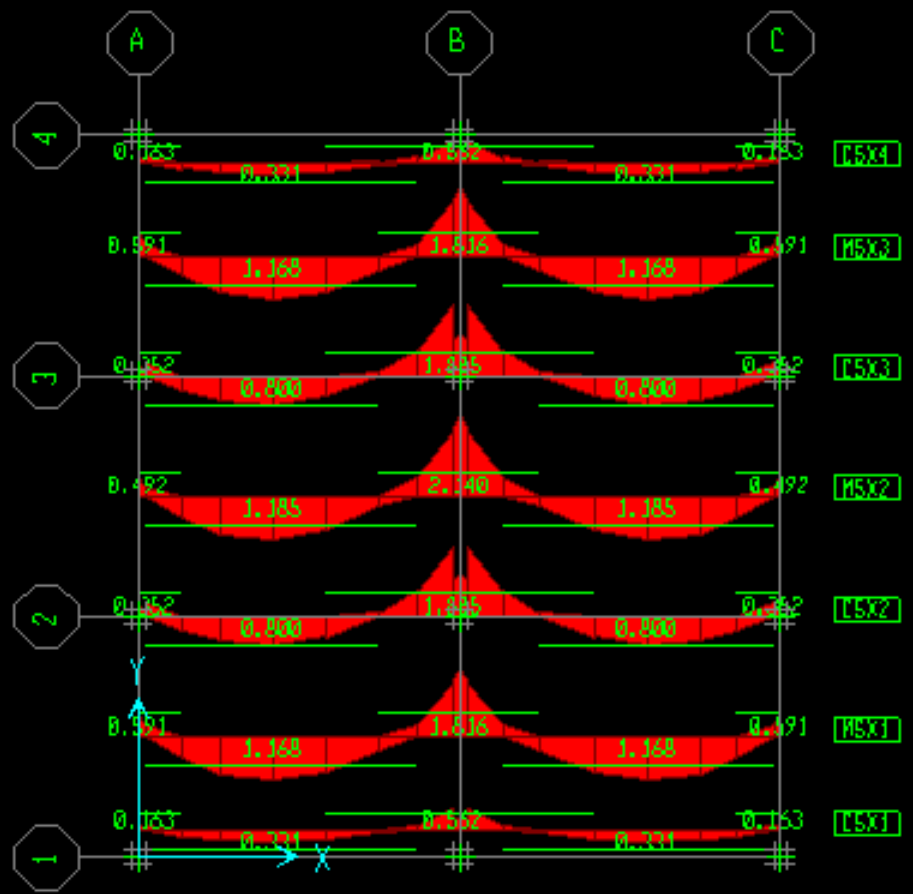



- Start Design
- Select Design Combos... Ctrl+F6
- Display Slab Design Info... Ctrl+F8
- Display Beam Design Info...
- Display Punching Shear Ratios
- Show Design Tables...
- Show Total Quantities...

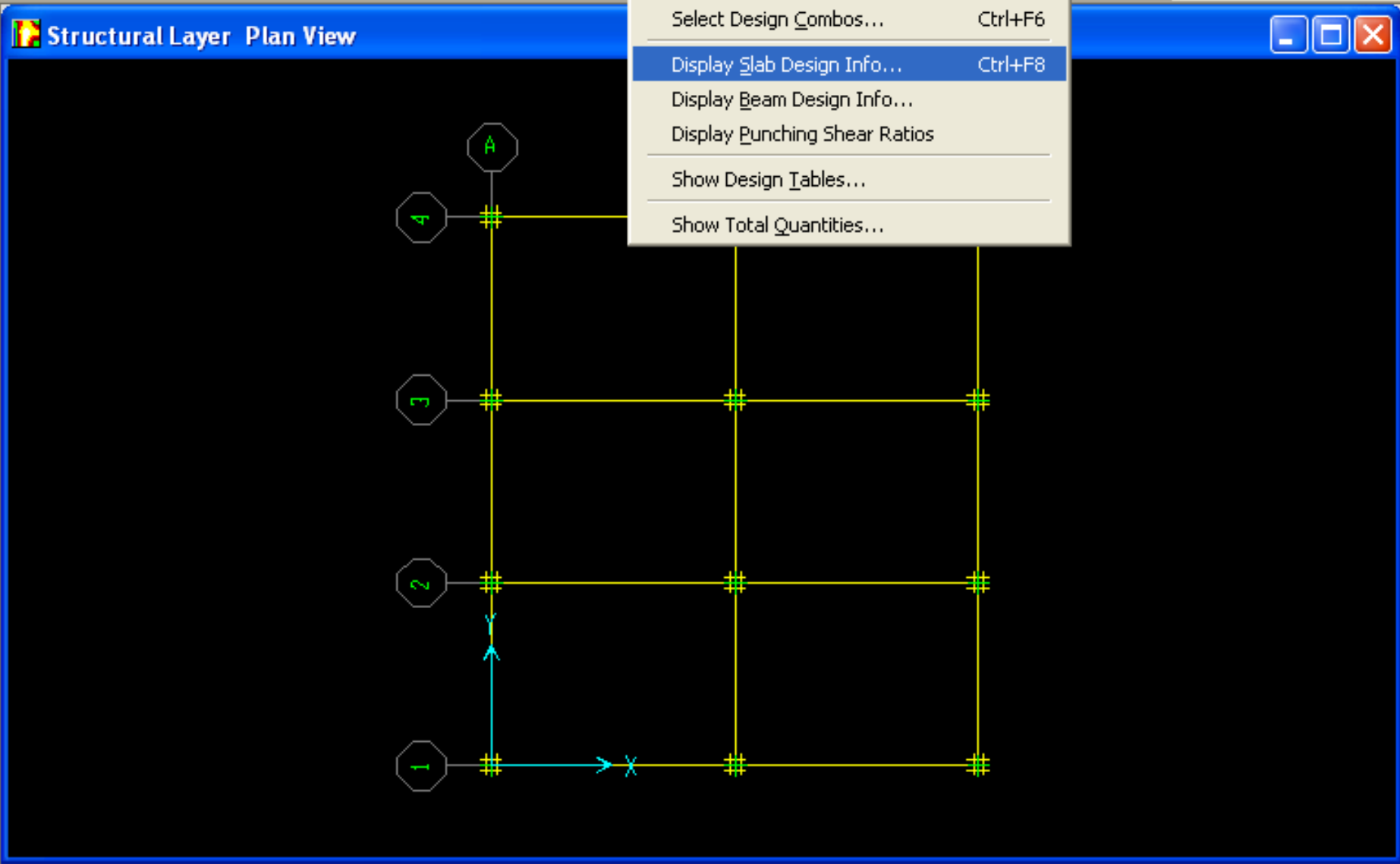

### Slab Reinforcing

**Choose Strip Direction**

X Direction Strip     Y Direction Strip

**Rebar Location Shown**

Show Top Rebar     Show Bottom Rebar

**Reinforcing Display Type**

Show Rebar Area

Show Number of Bars of Size:

Top: #5    Bottom: #5

**Reinforcing Diagram**

Show Reinforcing Envelope Diagram

Scale Factor: 1.

Show Reinforcing Extent

**Reinforcing Values**

Show Rebar at Controlling Station

Show Rebar at Every Station

Show Rebar Above Typical Value

**Typical Value of Reinforcing**

Define by Bar Size and Spacing

Define by Bar Area and Spacing

	Bar Size	Bar Spacing
Top	#5	144.
Bottom	#5	144.

OK    Cancel

**Steel Area/ft = (Strip reinforcement area of steel)/(width of strip).**

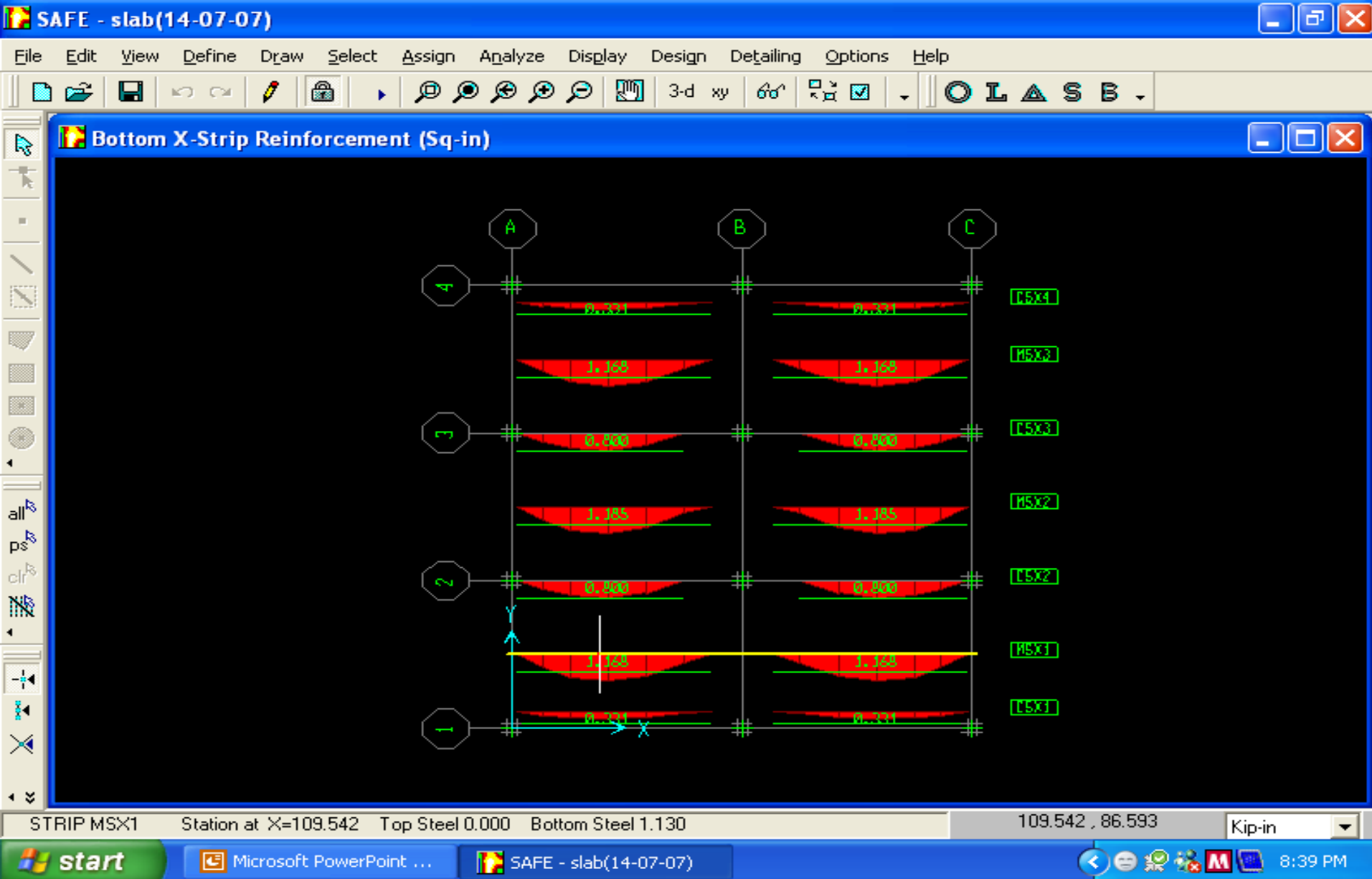

### Slab Reinforcing

**Choose Strip Direction**

X Direction Strip     Y Direction Strip

**Rebar Location Shown**

Show Top Rebar     Show Bottom Rebar

**Reinforcing Display Type**

Show Rebar Area

Show Number of Bars of Size:

Top: #5    Bottom: #5

**Reinforcing Diagram**

Show Reinforcing Envelope Diagram

Scale Factor: 1.

Show Reinforcing Extent

**Reinforcing Values**

Show Rebar at Controlling Station

Show Rebar at Every Station

Show Rebar Above Typical Value

**Typical Value of Reinforcing**

Define by Bar Size and Spacing

Define by Bar Area and Spacing

	Bar Size	Bar Spacing
Top	#5	144.
Bottom	#5	144.

OK    Cancel



### Top X-Strip Reinforcement (Sq-in)

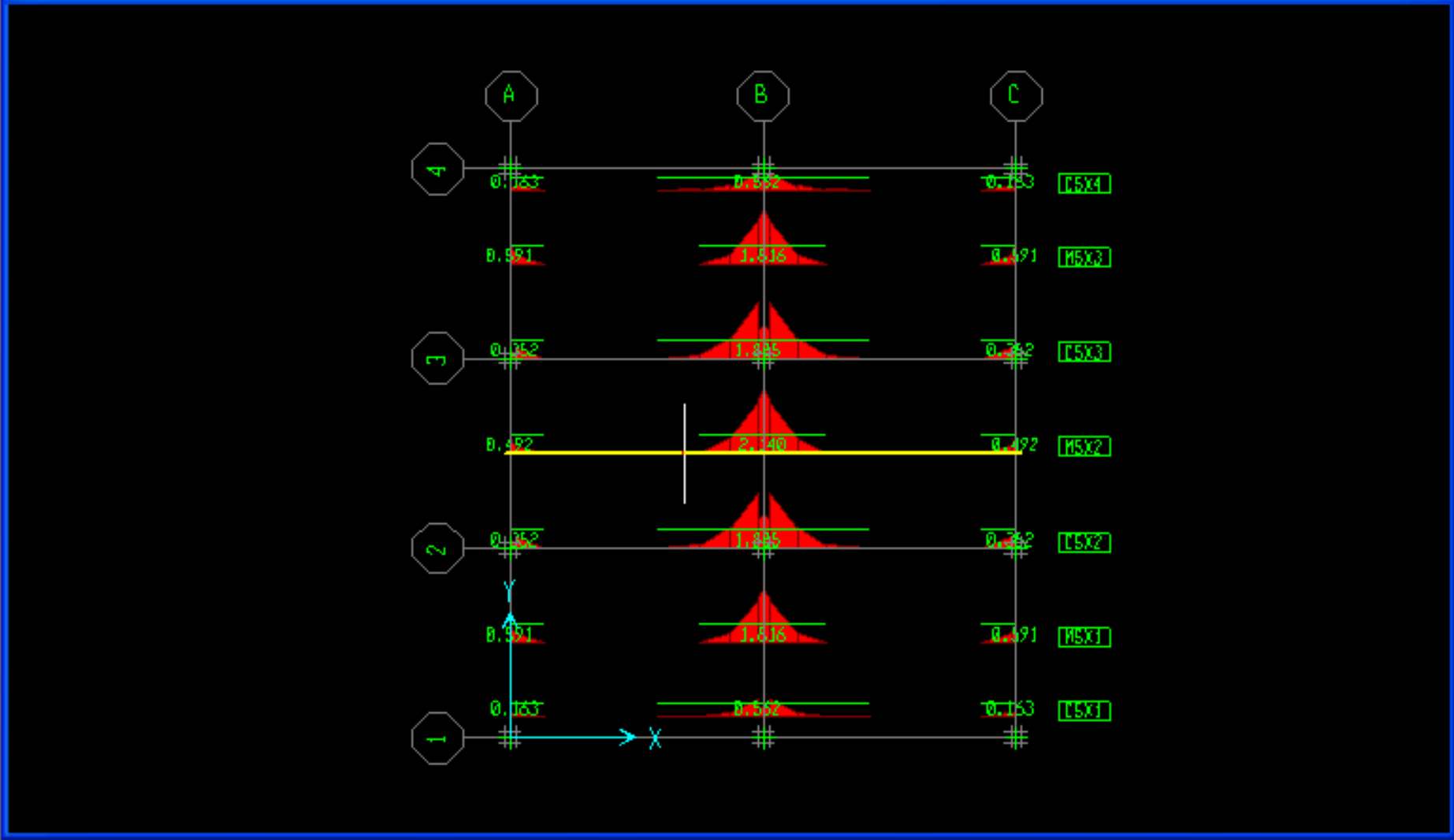

Top X-Strip Reinforcement (Sq-in)

### Slab Reinforcing

**Choose Strip Direction**

X Direction Strip    Y Direction Strip

**Rebar Location Shown**

Show Top Rebar    Show Bottom Rebar

**Reinforcing Display Type**

Show Rebar Area

Show Number of Bars of Size:

Top: #5   Bottom: #5

**Reinforcing Diagram**

Show Reinforcing Envelope Diagram

Scale Factor: 1.

Show Reinforcing Extent

**Reinforcing Values**

Show Rebar at Controlling Station

Show Rebar at Every Station

Show Rebar Above Typical Value

**Typical Value of Reinforcing**

Define by Bar Size and Spacing

Define by Bar Area and Spacing

	Bar Size	Bar Spacing
Top	#5	12.
Bottom	#5	12.

OK   Cancel

### Bottom Y-Strip Reinforcement (Sq-in)

[-] [Maximize] [Close]

[Pencil] [Eraser] [Select] [Move] [Copy] [Paste] [Undo] [Redo] [Zoom In] [Zoom Out] [3D View] [Angle] [View] [Layers]

[All] [Pick] [Clear] [Hatch] [Zoom In] [Zoom Out] [3D View] [Angle] [View] [Layers]

[Start] [Microsoft PowerPoint ...] [SAFE - slab(14-07-07)] [8:50 PM]

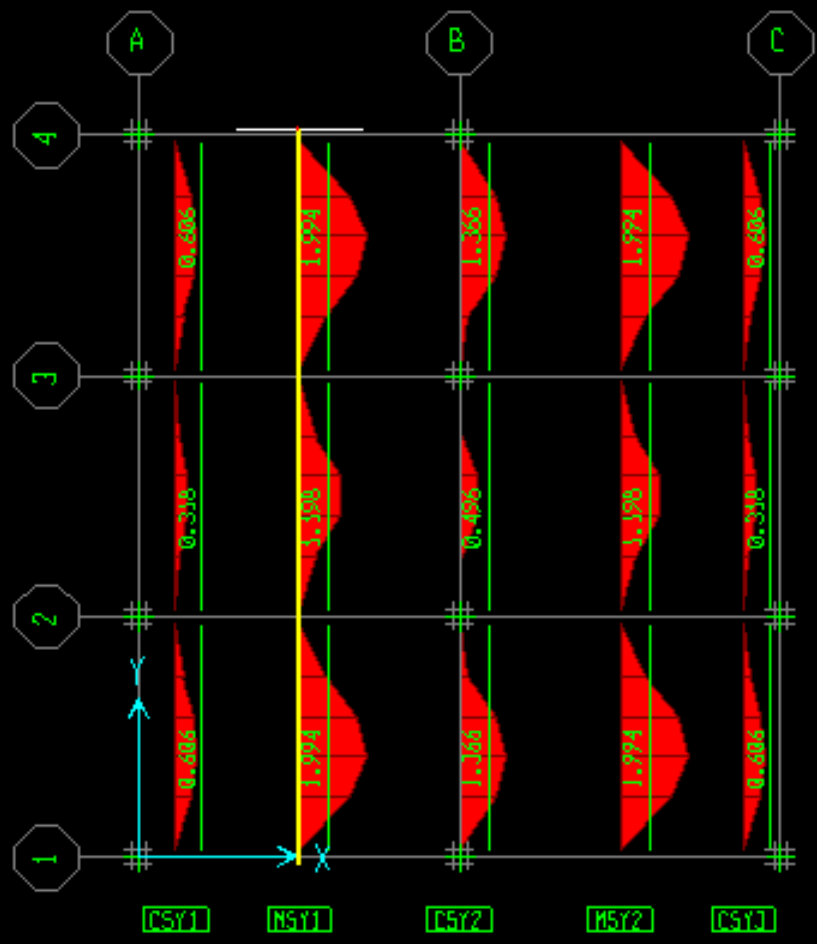

### Slab Reinforcing

**Choose Strip Direction**

X Direction Strip    Y Direction Strip

**Rebar Location Shown**

Show Top Rebar    Show Bottom Rebar

**Reinforcing Display Type**

Show Rebar Area

Show Number of Bars of Size:

Top: #5   Bottom: #5

**Reinforcing Diagram**

Show Reinforcing Envelope Diagram

Scale Factor: 1.

Show Reinforcing Extent

**Reinforcing Values**

Show Rebar at Controlling Station

Show Rebar at Every Station

Show Rebar Above Typical Value

**Typical Value of Reinforcing**

Define by Bar Size and Spacing

Define by Bar Area and Spacing

	Bar Size	Bar Spacing
Top	#5	12.
Bottom	#5	12.

OK   Cancel

### Top Y-Strip Reinforcement (Sq-in)

[-] [Maximize] [Close]

[Hand] [Move] [Copy] [Paste] [Delete] [Undo] [Redo] [Lock] [Zoom In] [Zoom Out] [Zoom Reset] [3-d] [xy] [Angle: 60°] [View: Top] [Zoom: In/Out/Reset]

[All] [Part] [Class] [Layer] [Color] [Line Style] [Width] [Height] [Material] [Pattern] [Fill] [Hatch] [Text] [Image] [Image Mask] [Image Stretch] [Image Rotate] [Image Flip] [Image Mirror] [Image Scale] [Image Crop] [Image Paste] [Image Delete] [Image Undo] [Image Redo] [Image Lock] [Image Unlock] [Image Hide] [Image Show] [Image Freeze] [Image Unfreeze] [Image Lock] [Image Unlock] [Image Hide] [Image Show] [Image Freeze] [Image Unfreeze]

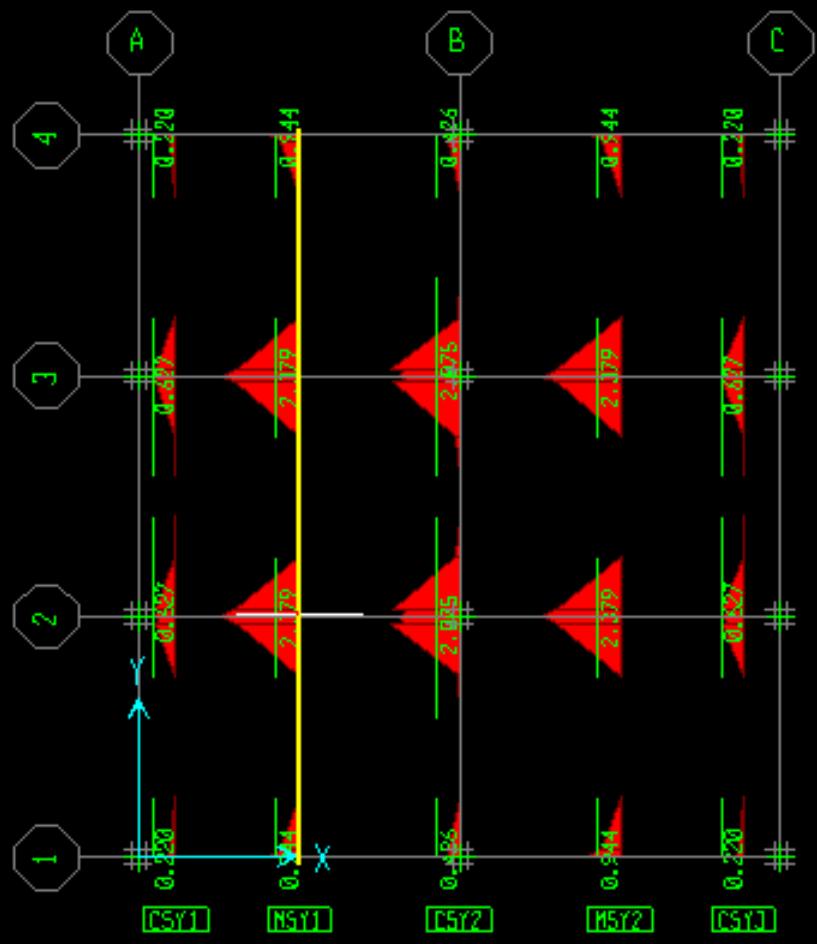



- Start Design
- Select Design Combos... Ctrl+F6
- Display Slab Design Info... Ctrl+F8
- Display Beam Design Info...
- Display Punching Shear Ratios
- Show Design Tables...
- Show Total Quantities...

Structural Layer Plan View

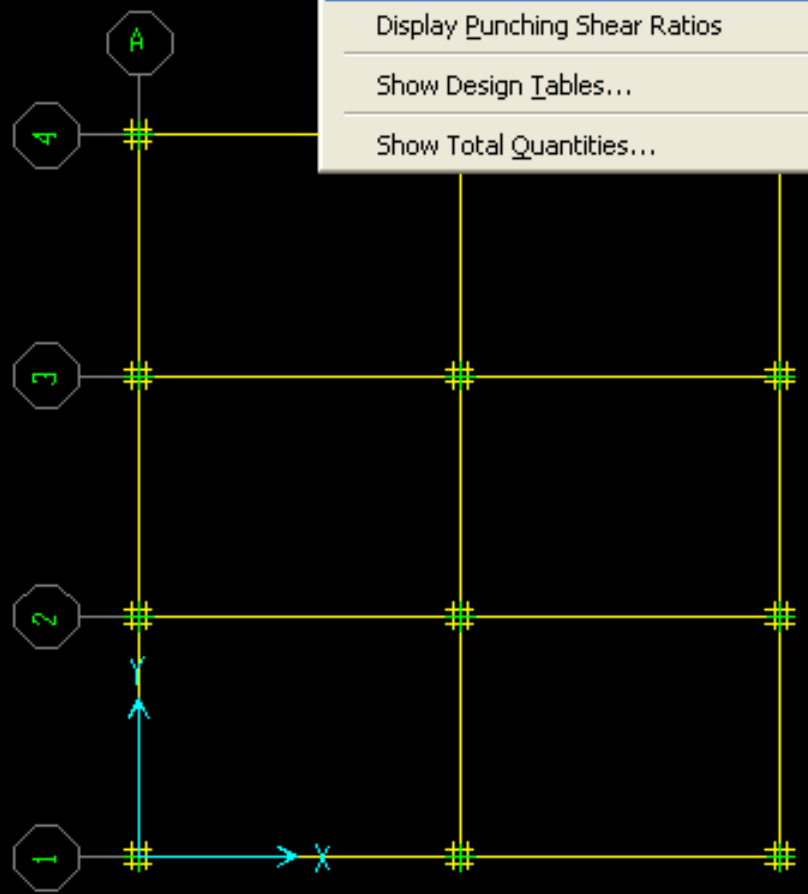

### Beam Reinforcing

Type of Reinforcing

Flexural Reinforcing  Shear Reinforcing

Reinforcing Values

Show Rebar Values at Controlling Station  
 Show Rebar Values at Every Station

Reinforcing Diagram

Show Reinforcing Envelope Diagram  
Scale Factor   
 Show Reinforcing Extent

OK Cancel

### Beam Flexural Reinforcement (Sq-in)

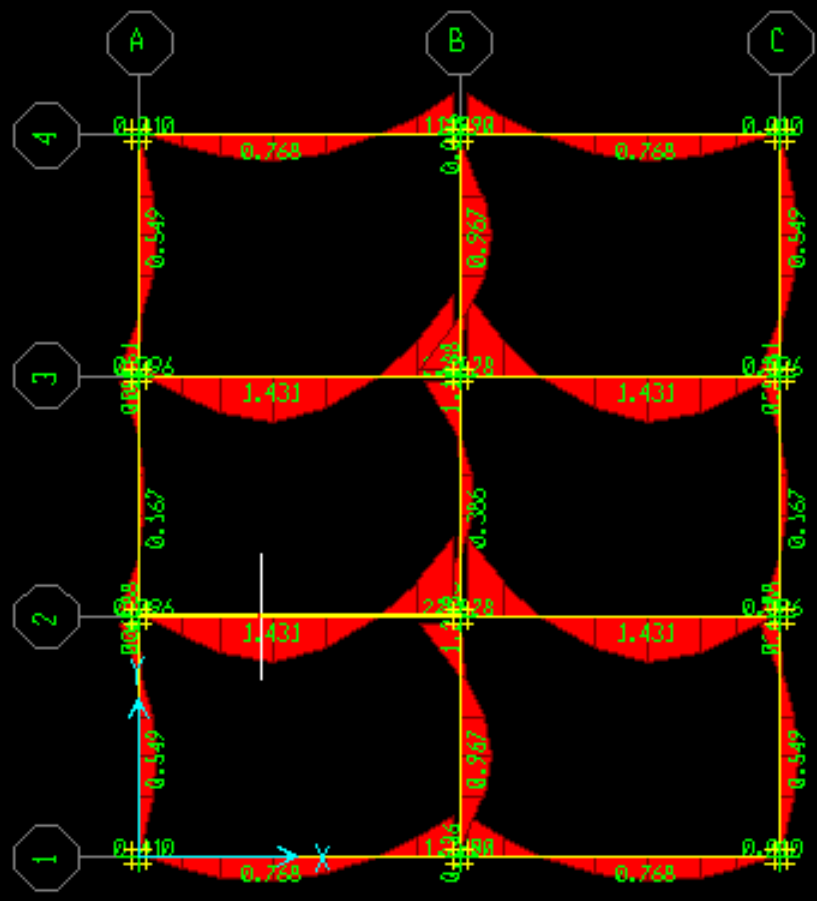





- Start Design
- Select Design Combos... Ctrl+F6
- Display Slab Design Info... Ctrl+F8
- Display Beam Design Info...
- Display Punching Shear Ratios
- Show Design Tables...
- Show Total Quantities...

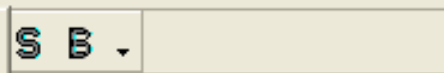

Structural Layer Plan View

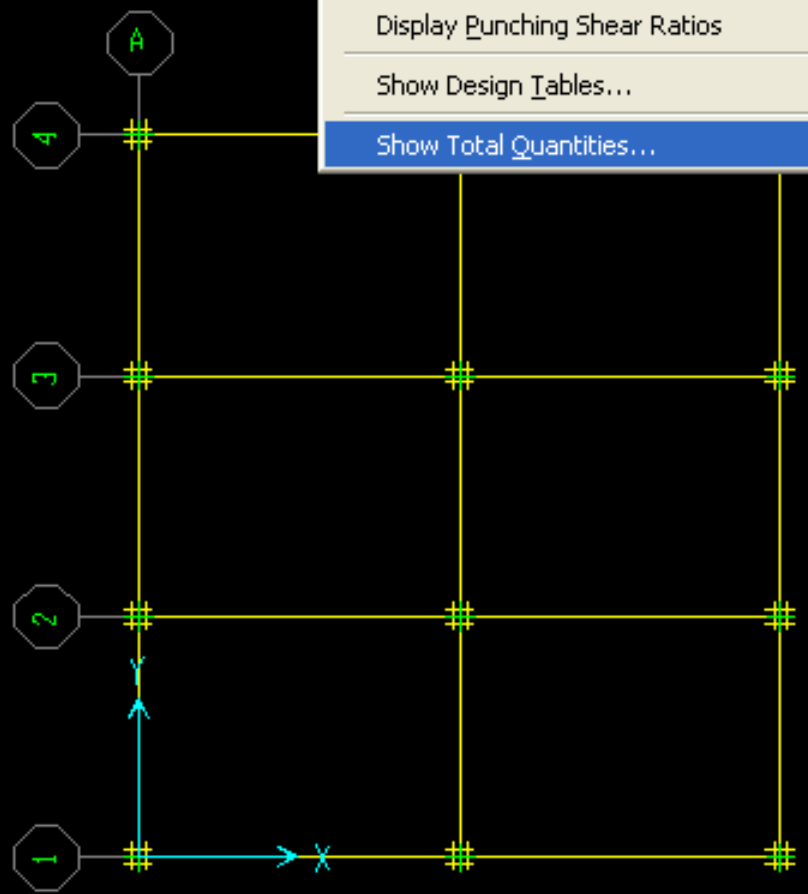

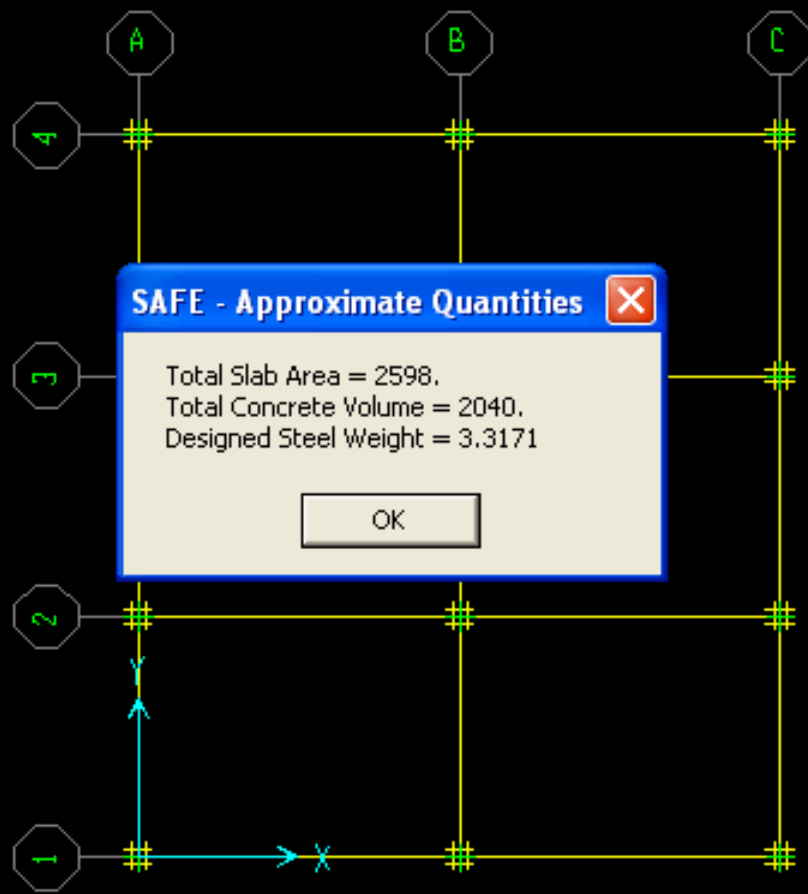

**SAFE - Approximate Quantities**

Total Slab Area = 2598.  
Total Concrete Volume = 2040.  
Designed Steel Weight = 3.3171

OK



- Start Design
- Select Design Combos... Ctrl+F6
- Display Slab Design Info... Ctrl+F8
- Display Beam Design Info...
- Display Punching Shear Ratios
- Show Design Tables...
- Show Total Quantities...

Structural Layer Plan View

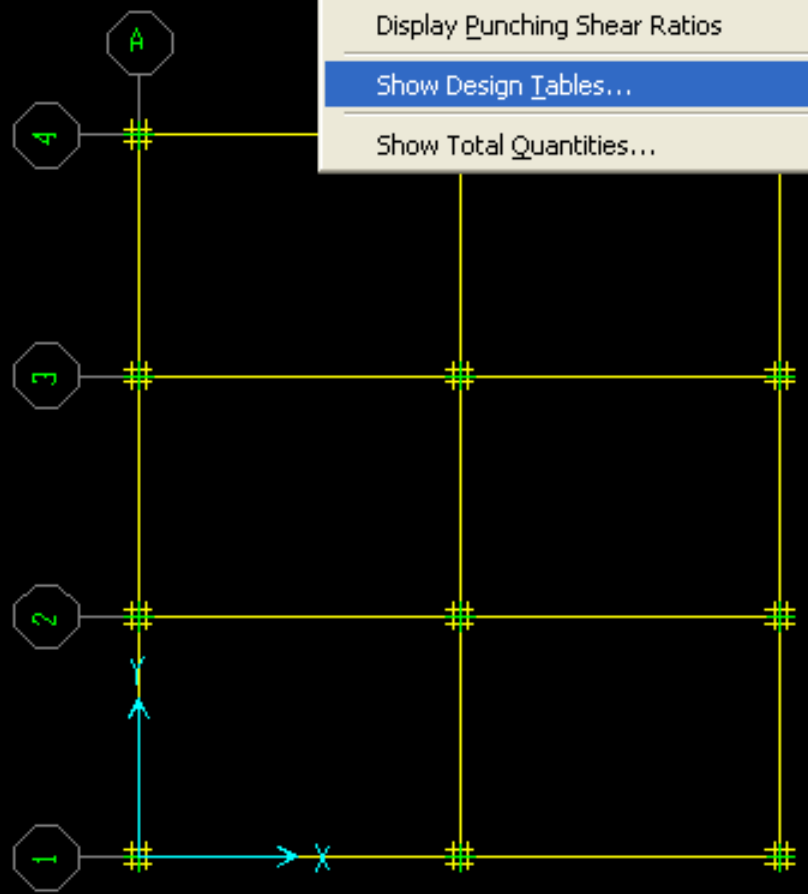

### Design Tables

<p>Design Output</p> <ul style="list-style-type: none"><li><input checked="" type="checkbox"/> Slab Strip Reinforcing</li><li><input type="checkbox"/> Beam Reinforcing</li><li><input type="checkbox"/> Punching Shear</li></ul>	<p>Design Forces</p> <ul style="list-style-type: none"><li><input checked="" type="checkbox"/> Slab Strip</li><li><input type="checkbox"/> Beam</li></ul>
---	---

Selection Only

File Name

OK Cancel

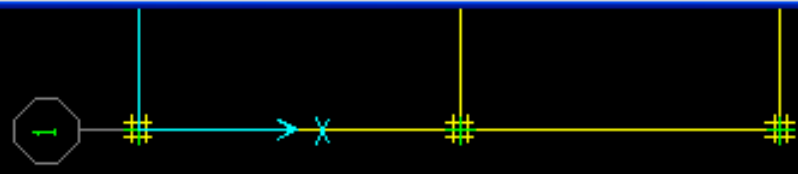

Structural Layer Plan View

X-Strip Reinforcing

	X Strip	Width	X	Top_Left	Top_Right	Bottom_Left	Bottom
▶	CSX4	5	-0.5				
	CSX4	5	0		0.1100821		
	CSX4	5	0.5	7.866988E-02	0.1627525		
	CSX4	5	3.25		0	0.1899134	0.1735
	CSX4	5	6			0.279813	0.2794
	CSX4	5	10			0.3305426	0.3300
	CSX4	5	14			0.2559299	0.2589
	CSX4	5	18	8.369537E-03	0	6.940623E-02	6.595591
	CSX4	5	20.75	0.1445024	0.1270921		0
	CSX4	5	23.5	0.5622504	0.3066518		
	CSX4	5	24	0.3540883	0.3540883		
	CSX4	5	24.5	0.5622504	0.5622504		

XStripRebar

◀ ▶

OK

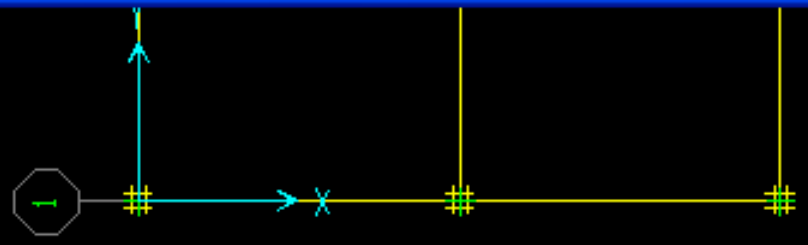

### Y-Strip Reinforcing

	Y Strip	Width	Y	Top_Left	Top_Right	Bottom_Left	Bottom
▶	CSY1	6.5	-0.5				
	CSY1	6.5	0		0.2199267		
	CSY1	6.5	0.5	0.1418277	0.177244		0
	CSY1	6.5	4.5			0.4955346	0.4832
	CSY1	6.5	7.5			0.6044196	0.6057
	CSY1	6.5	10.5			0.5122579	0.5143
	CSY1	6.5	13.5	0	0	0.2147379	0.2202
	CSY1	6.5	17.5	0.6188222	0.4886752		
	CSY1	6.5	18	0.5874705	0.6046436		
	CSY1	6.5	18.5	0.5076665	0.6273743		
	CSY1	6.5	22.5	0	7.243719E-03	0.1225079	0.1157
	CSY1	6.5	25.5			0.2170017	0.2175

YStripRebar  
 XStripRebar  
**YStripRebar**  
 XStripMoments  
 YStripMoments

OK

