

Chapter 16-17

An Introduction and Application to Infrared Spectrometry

The infrared region of the spectrum encompasses radiation with wavenumbers ranging from about 12,800 to 10 cm^{-1} or wavelengths from 0.78 to 1000 μm . The infrared spectrum is divided into **near-**, **mid-**, and **far-** infrared radiation.

TABLE 16-1 IR Spectral Regions

Region	Wavelengths (λ), μm	Wavenumbers ($\bar{\nu}$), cm^{-1}	Frequencies (ν), Hz
Near	0.78 to 2.5	12800 to 4000	3.8×10^{14} to 1.2×10^{14}
Middle	2.5 to 50	4000 to 200	1.2×10^{14} to 6.0×10^{12}
Far	50 to 1000	200 to 10	6.0×10^{12} to 3.0×10^{11}
Most used	2.5 to 15	4000 to 670	1.2×10^{14} to 2.0×10^{13}

Infrared Spectroscopy

A) Introduction

- A) 1.) Infrared (IR) spectroscopy: based on IR absorption by molecules as undergo vibrational and rotational transitions. Absorption of radiation in this region by a typical organic molecule results in the excitation of vibrational, rotational and bending modes, while the molecule itself remains in its electronic ground state.

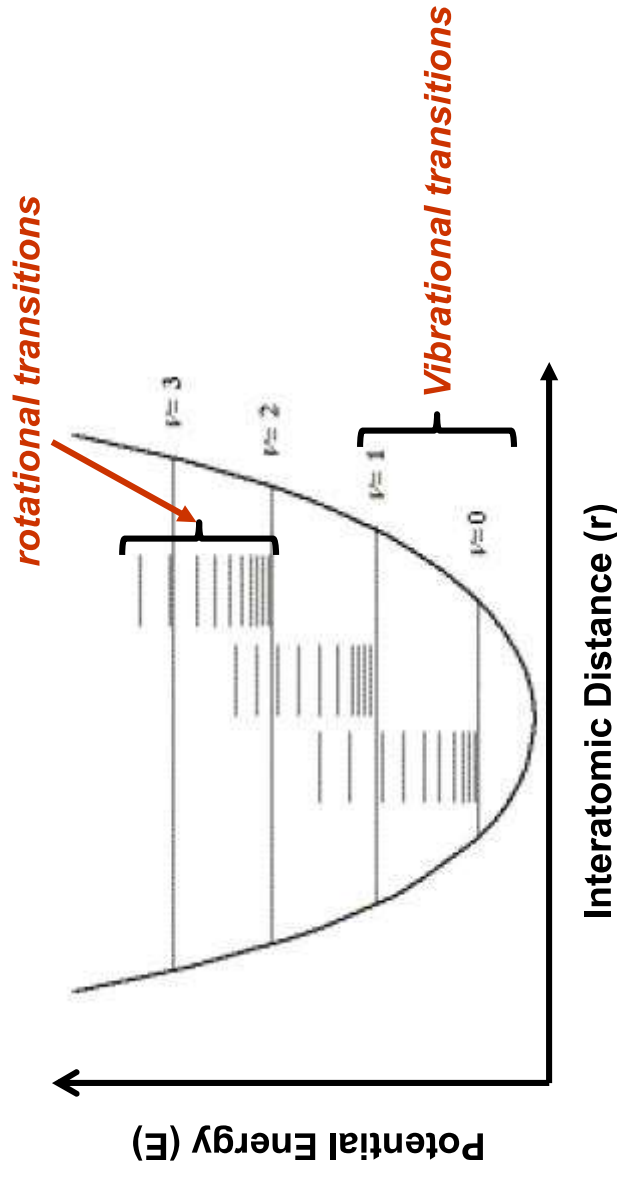

Potential energy resembles classic Harmonic Oscillator

- 2.) IR radiation is in the range of $12,800 - 10 \text{ cm}^{-1}$ or $\lambda = 0.78 - 1000 \text{ }\mu\text{m}$
- rotational transitions have small energy differences
 - $\leq 100 \text{ cm}^{-1}$, $\lambda > 100 \text{ }\mu\text{m}$
 - vibrational transitions occur at higher energies
 - rotational and vibrational transitions often occur together

3.) Typical IR spectrum for Organic Molecule

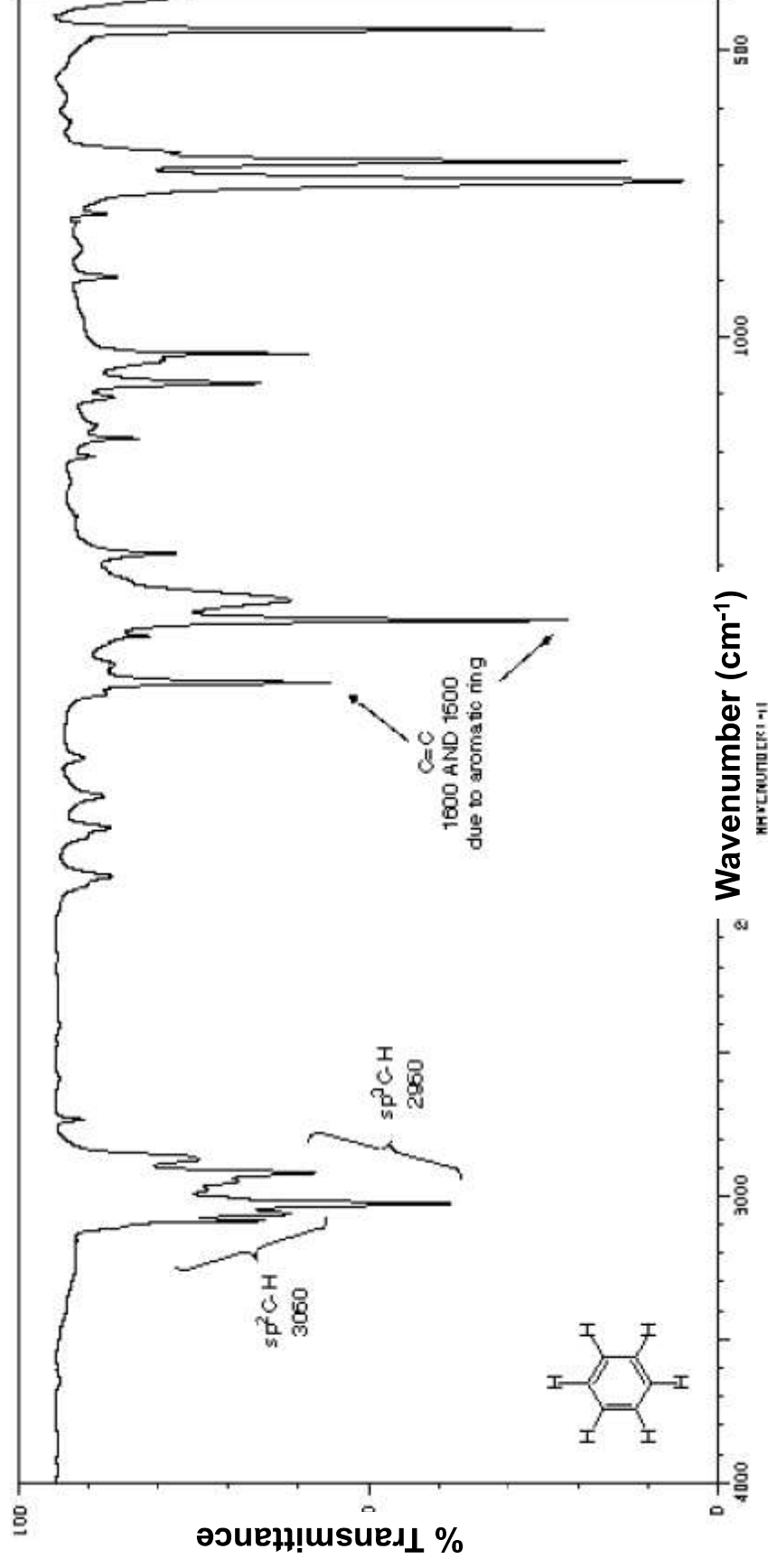

Wide Range of Types of Electromagnetic Radiation in nature.

1. Only a small fraction (350-780 nm) is visible light.
2. The complete variety of electromagnetic radiation is used throughout spectroscopy.
3. Different energies allow monitoring of different types of interactions with matter.

$$E=hc/\lambda$$

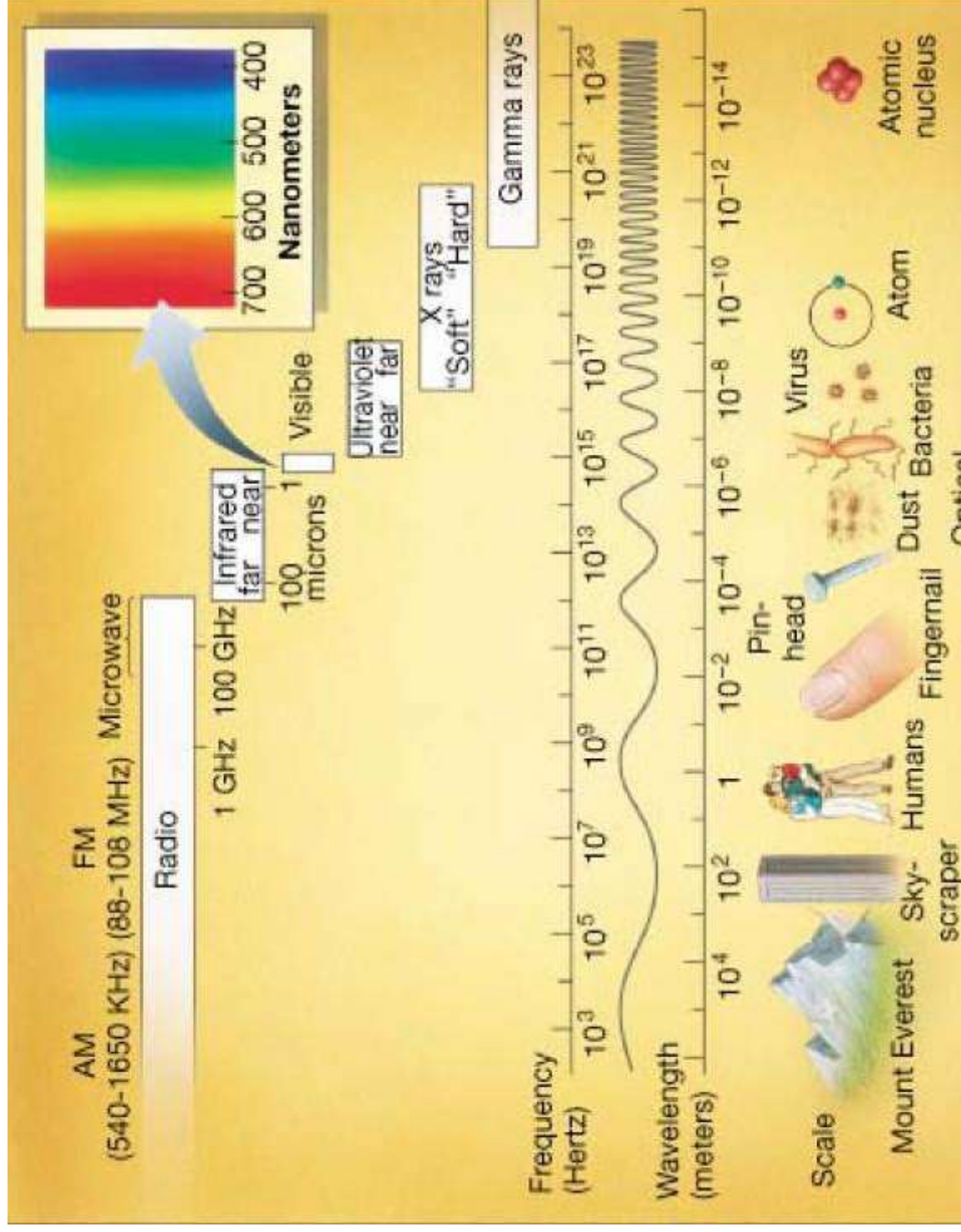

3.) Typical IR spectrum for Organic Molecule

- many more bands than in UV-vis, fluorescence or phosphorescence
- bands are also much sharper
- pattern is distinct for given molecule
 - except for optical isomers
- good qualitative tool
 - can be used for compound identification
 - group analysis
- also quantitative tool
 - intensity of bands related to amount of compound present
- spectra usually shown as percent transmittance (instead of absorbance) vs. wavenumber (instead of λ) for convenience

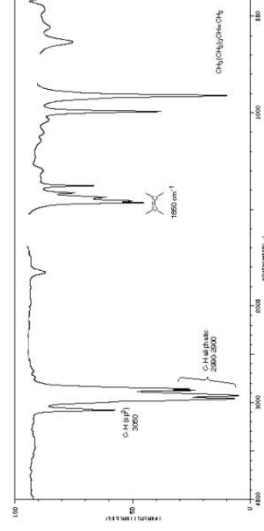
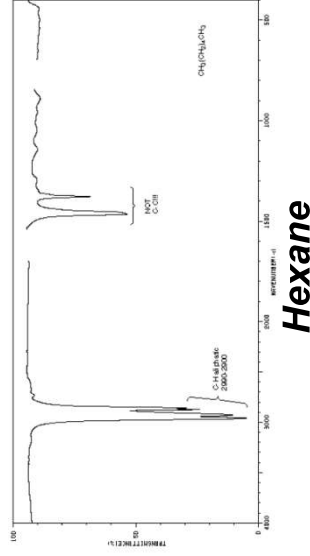

Hexene

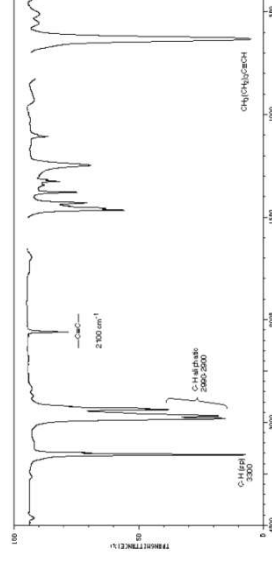

Hexyne

B) Theory of IR Absorption

1.) Molecular Vibrations

i.) Harmonic Oscillator Model:

- approximate representation of atomic stretching
- two masses attached by a spring

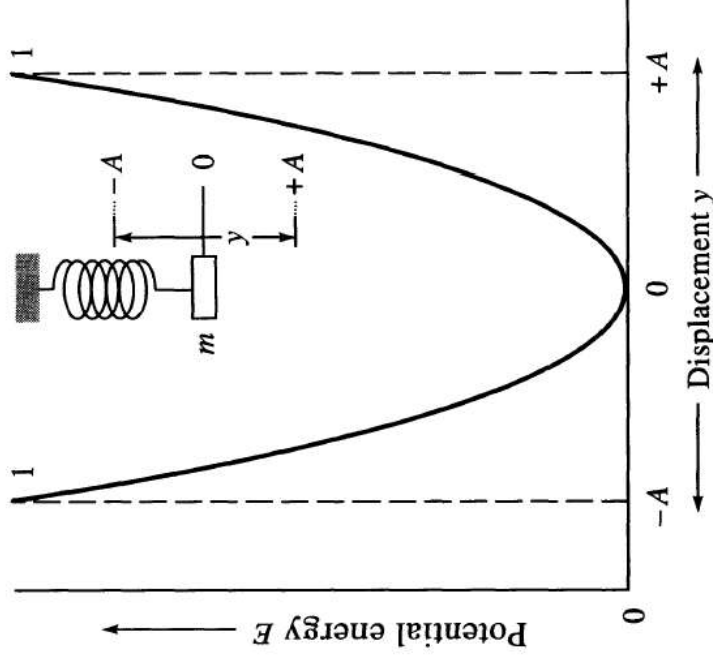

$$E = \frac{1}{2} ky^2$$

where:

y is spring displacement

k is spring constant

Vibrational frequency given by:

$$\nu = 1 / 2\pi \sqrt{k / m}$$

where:

- ν : frequency
- k : force constant (measure of bond stiffness)
- μ : reduced mass – $m_1 m_2 / m_1 + m_2$

If know ν and atoms in bond, can get k :

Single bonds:
 $k \sim 3 \times 10^2$ to 8×10^2 N/m (Avg $\sim 5 \times 10^2$)

double and triple bonds $\sim 2x$ and $3x$ k for single bond.

$\nu \propto \sqrt{k}$ So, vibration ν occur in order:
 single < double < triple

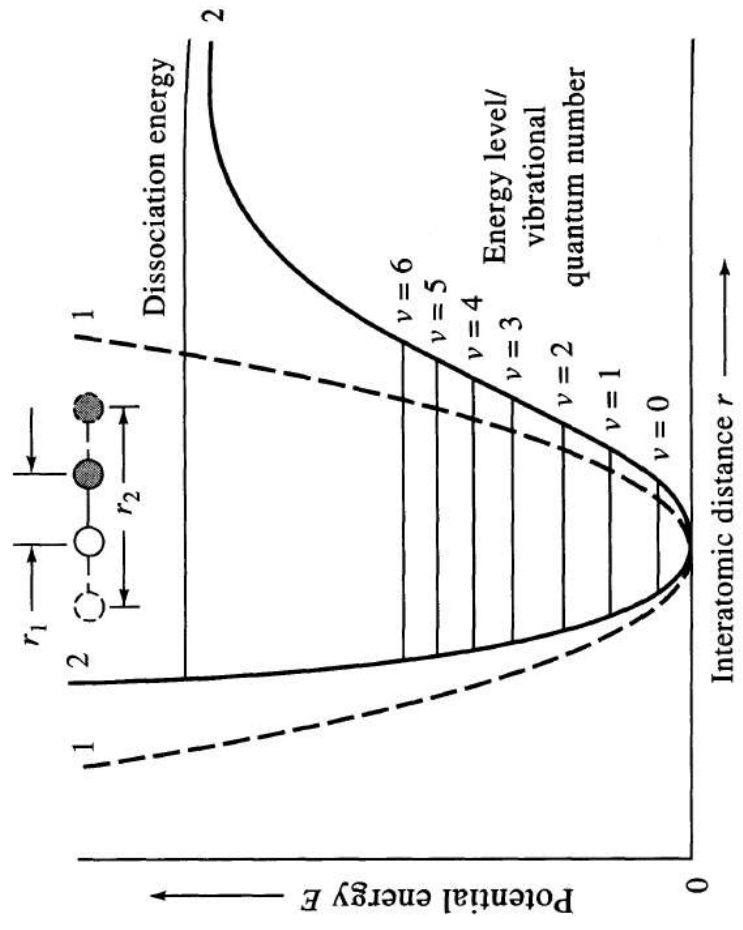

ii.) Anharmonic oscillation:

- harmonic oscillation model good at low energy levels (v_0, v_1, v_2, \dots)
- not good at high energy levels due to atomic repulsion & attraction
 - as atoms approach, coulombic repulsion force adds to the bond force making energy increase greater than harmonic
 - as atoms separate, approach dissociation energy and the harmonic function rises quicker

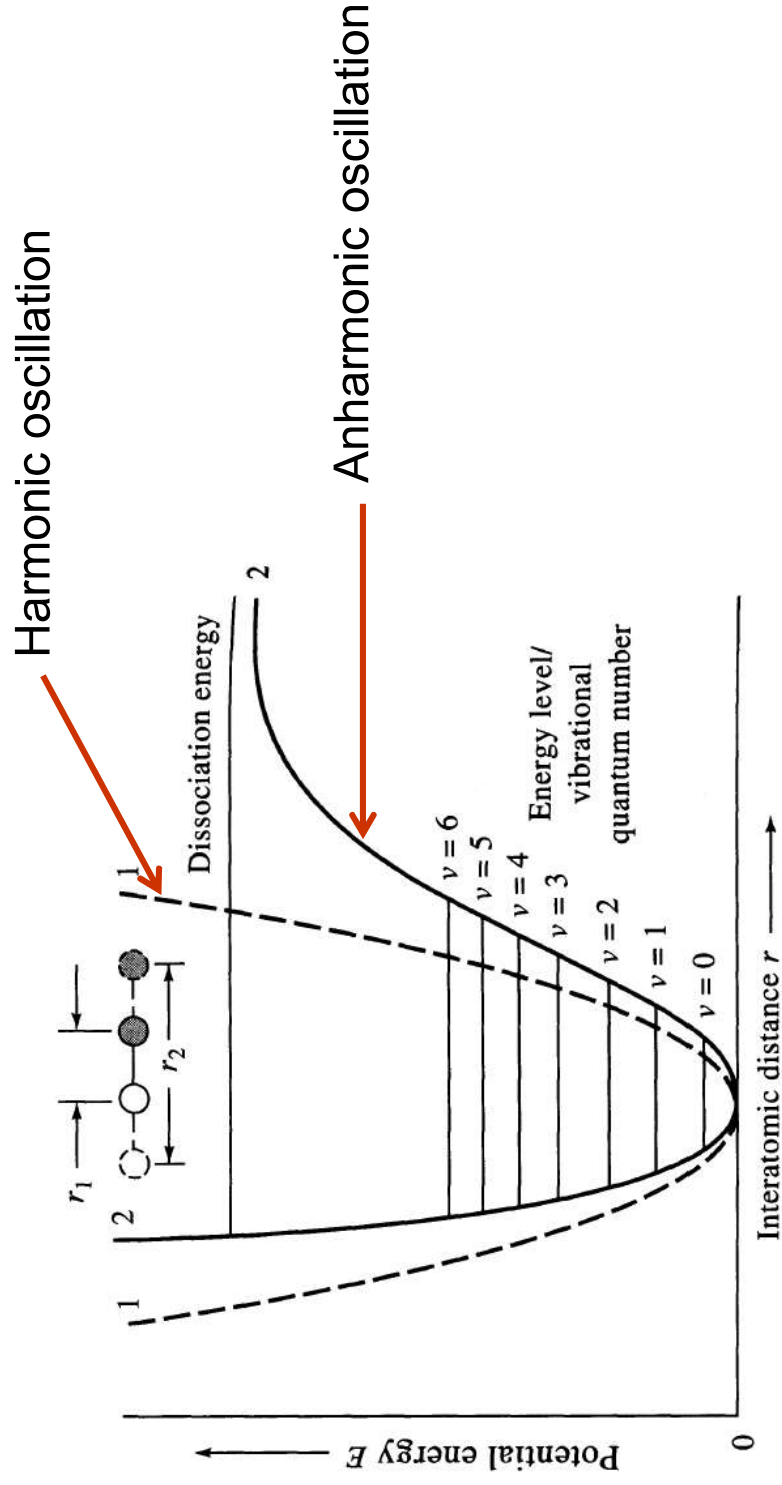

Because of anharmonics: at low ΔE , $\Delta v = \pm 2, \pm 3$ are observed which cause the appearance of overtone lines at frequencies at $\sim 2-3$ times the fundamental frequency. Normally $\Delta v = \pm 1$

iii.) Types of Molecular Vibrations

Bond Stretching

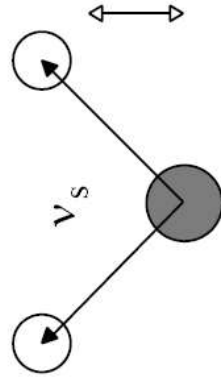

symmetric

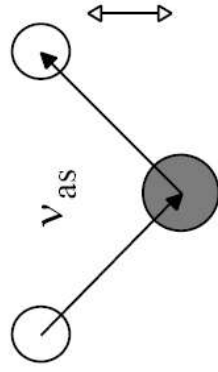

asymmetric

Bond Bending

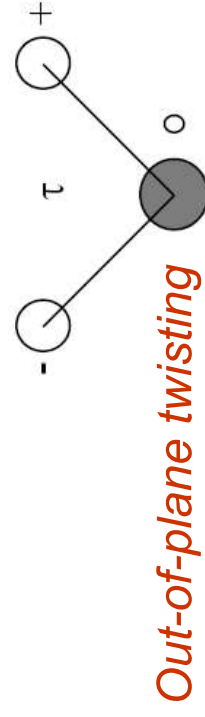
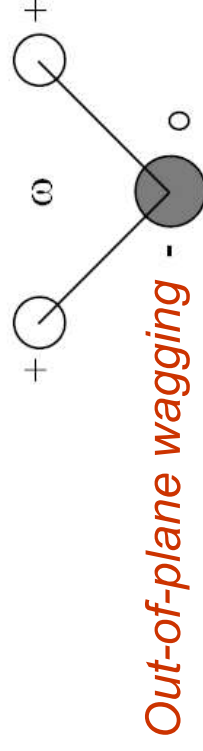
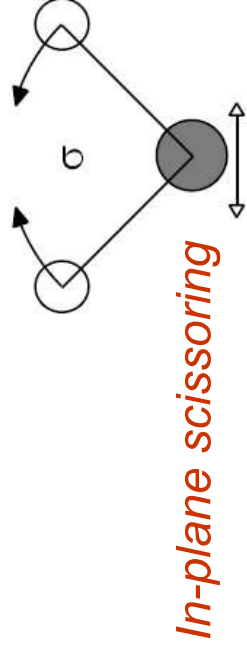
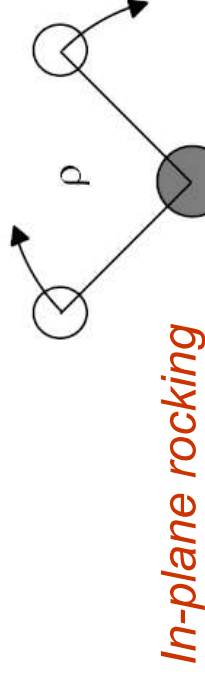

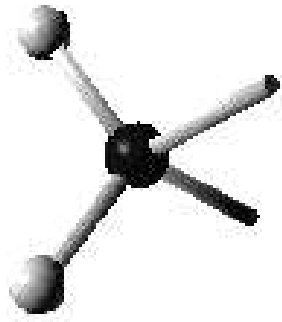

Copyright © 1997 Charles B. Abrams

symmetric

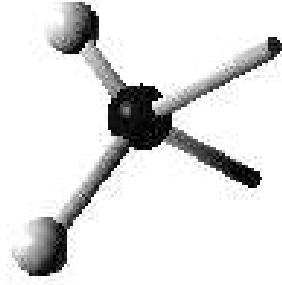

Copyright © 1997 Charles B. Abrams

asymmetric

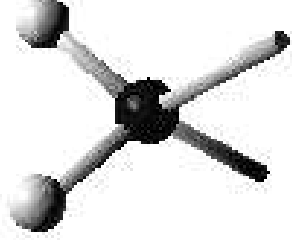

Copyright © 1997 Charles B. Abrams

In-plane scissoring

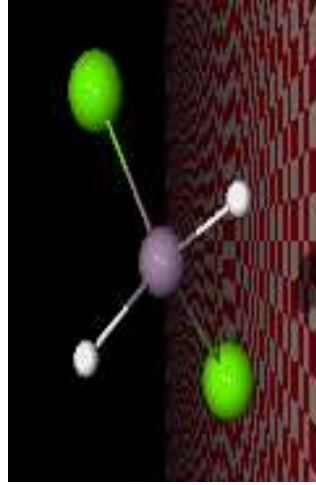

Out-of-plane twisting

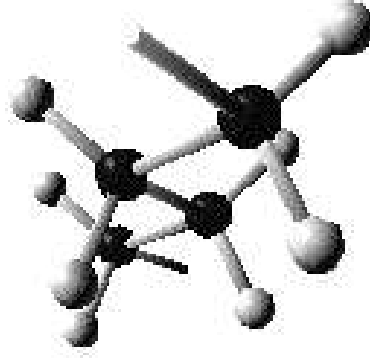

Copyright © 1997 Charles B. Abrams

In-plane rocking

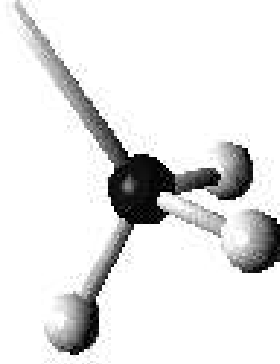

Copyright © 1997 Charles B. Abrams

Out-of-plane wagging

iv.) Number of Vibrational Modes:

- for non-linear molecules, number of types of vibrations: $3N-6$
- for linear molecules, number of types of vibrations: $3N-5$
- why so many peaks in IR spectra
- observed vibration can be less than predicted because
 - symmetry (no change in dipole)
 - energies of vibration are identical
 - absorption intensity too low
 - frequency beyond range of instrument

Examples:

1) HCl: $3(2)-5 = 1$ mode

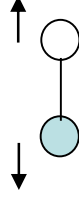

2) CO₂: $3(3)-5 = 4$ modes

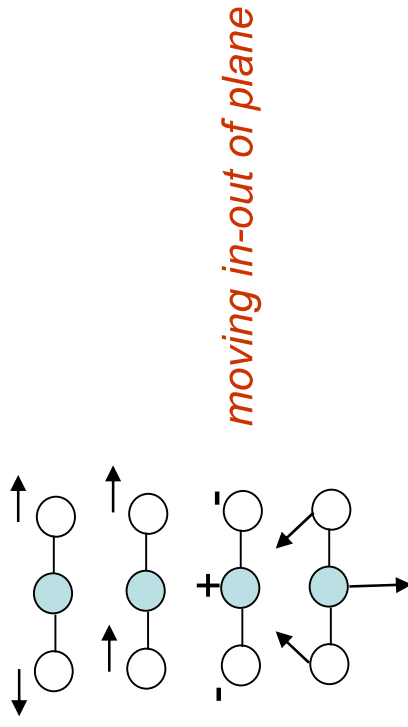

See web site for 3D animations of vibrational modes for a variety of molecules

<http://www.chem.purdue.edu/gchelp/vibs/co2.html>

v.) IR Active Vibrations:

- In order for molecule to absorb IR radiation:
 - vibration at same frequency as in light
 - but also, must have a change in its *net dipole moment* as a result of the vibration

Examples:

1) CO_2 : $3(3)-5 = 4$ modes

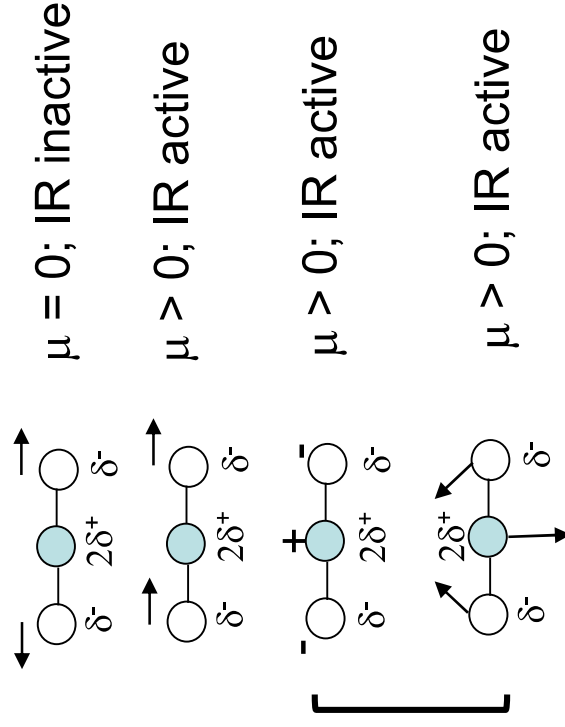

degenerate –identical energy single IR peak

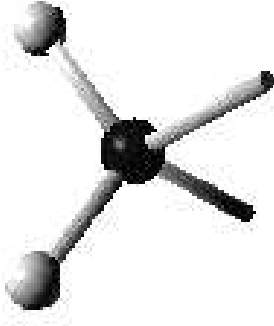

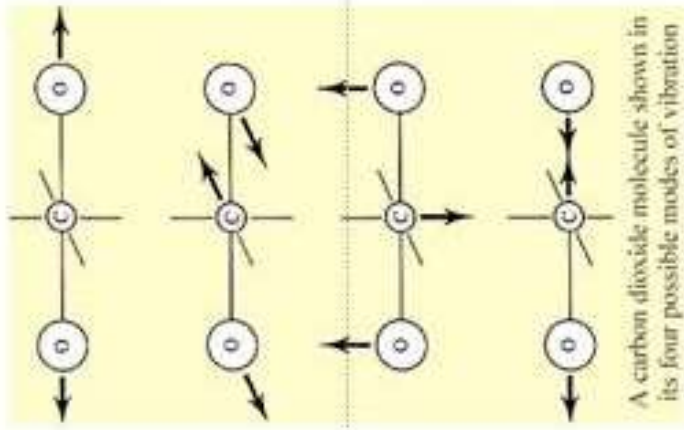
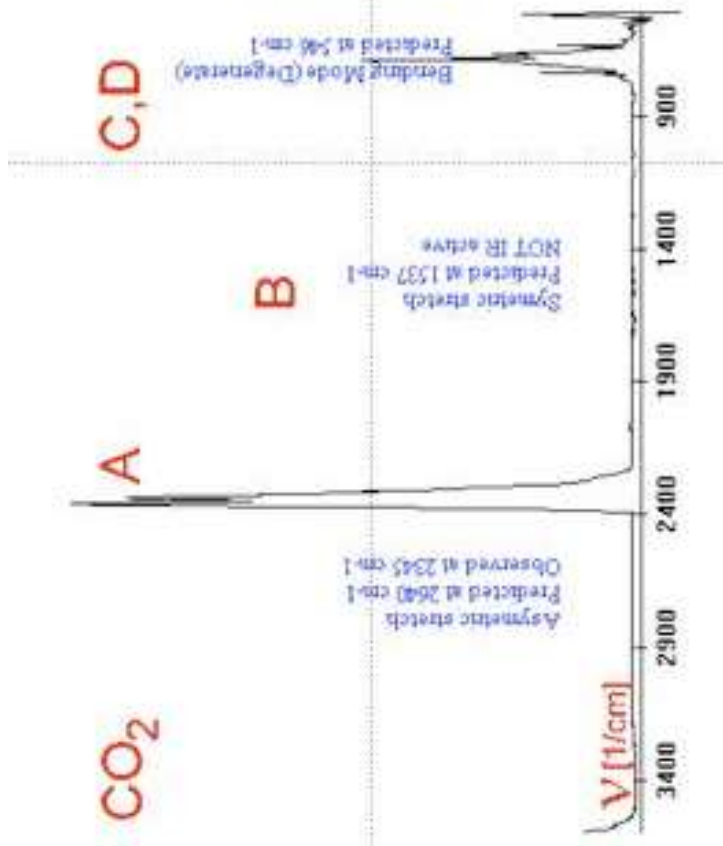

Example 8: Calculate the absorption frequency for the C-H stretch with a force constant of $k = 5.0 \times 10^2 \text{ N/m}$.

C) Instrumentation

1.) [Basic Design](#)

- normal IR instrument similar to UV-vis
- main differences are light source & detector

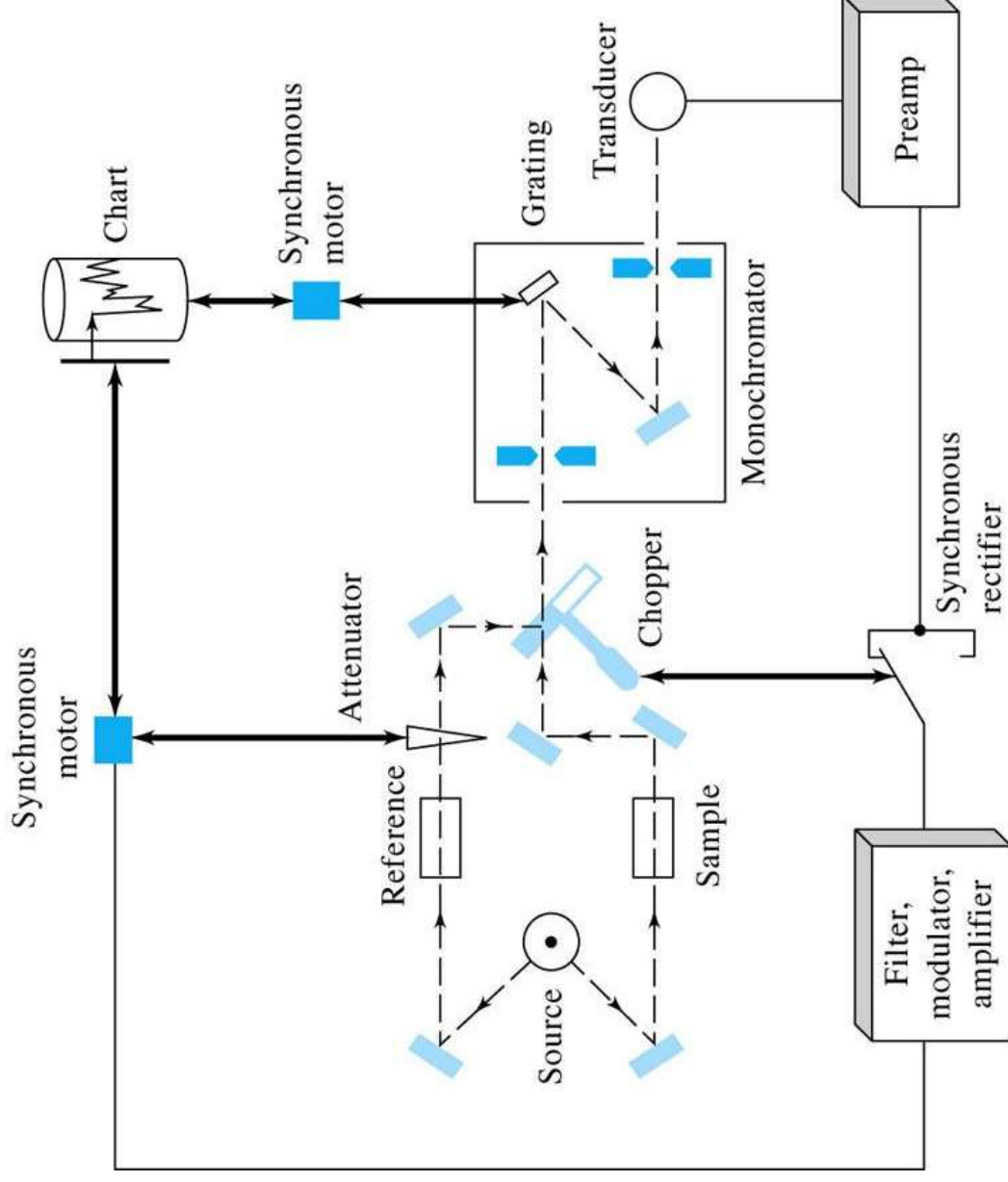

i.) Light Source:

- must produce IR radiation
- can't use glass since absorbs IR radiation
- several possible types

a) Nernst Glower

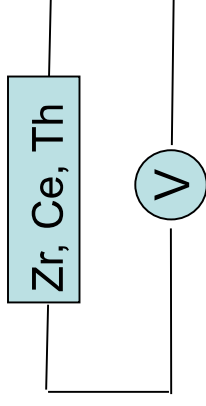

- rare earth metal oxides (Zr, Ce, Th) heated electrically
- apply current to cylinder, has resistance to current flow generates heat ($1200^{\circ} - 2200^{\circ} \text{C}$).
- causes light production similar to blackbody radiation
- range of use $\sim 670 - 10,000 \text{cm}^{-1}$
- need good current control or overheats and damaged

b) Globar

- similar to Nernst Glower but uses silicon carbide rod instead of rare earth oxides
- similar usable range

c) Incandescent Wire Source

- tightly wound nichrome or rodium wire that is electrically heated
- same principal as Nernst Glower
- lower intensity than Nernst Glower or Globar, but longer lifetime

d) CO₂ Laser

- CO₂ laser gas mixture consists of 70% He, 15% CO₂, and 15% N₂
- a voltage is placed across the gas, exciting N₂ to lowest vibrational levels.
- the excited N₂ populate the asymmetric vibrational states in the CO₂ through collisions.
- infrared output of the laser is the result of transitions between rotational states of the CO₂ molecule of the first asymmetric vibrational mode to rotational states of both the first symmetric stretch mode and the second bending mode
- gives off band of ~ 100 cm⁻¹'s in range of 900-1100 cm⁻¹
- small range but can choose which band used & many compounds have IR absorbance in this region
- much more intense than Blackbody sources

e) Others

- mercury arc ($\lambda > 50 \mu\text{m}$) (far IR)
- tungsten lamp (4000 -12,800cm⁻¹) (near IR)

ii.) Detectors:

- two main types in common IR instruments

a) Thermal Detectors

1.) *Thermocouple*

- two pieces of dissimilar metals fused together at the ends
- when heated, metals heat at different rates
- potential difference is created between two metals that varies with their difference in temperature
- usually made with blackened surface (to improve heat absorption)
- placed in evacuated tube with window transparent to IR (not glass or quartz)
- IR “hits” and heats one of the two wires.
- can use several thermocouples to increase sensitivity.

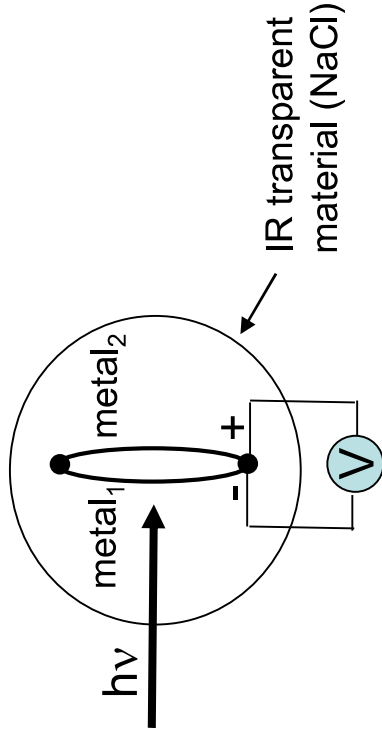

2.) Bolometer

- strips of metal (Pt, Ni) or semiconductor that has a large change in resistance to current with temperature.
- as light is absorbed by blackened surface, resistance increases and current decreases
- very sensitive

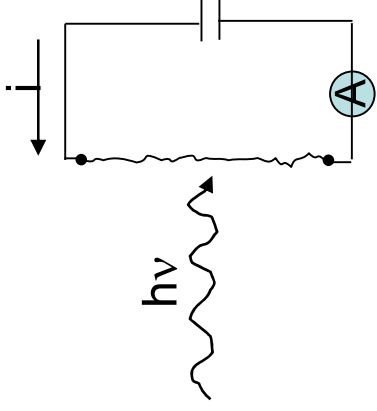

b) Photoconducting Detectors

- thin film of semiconductor (ex. PbS) on a nonconducting glass surface and sealed in a vacuum.
- absorption of light by semiconductor moves from non-conducting to conducting state
- decrease in resistance \rightarrow increase in current
- range: 10,000 -333 cm^{-1} at room temperature

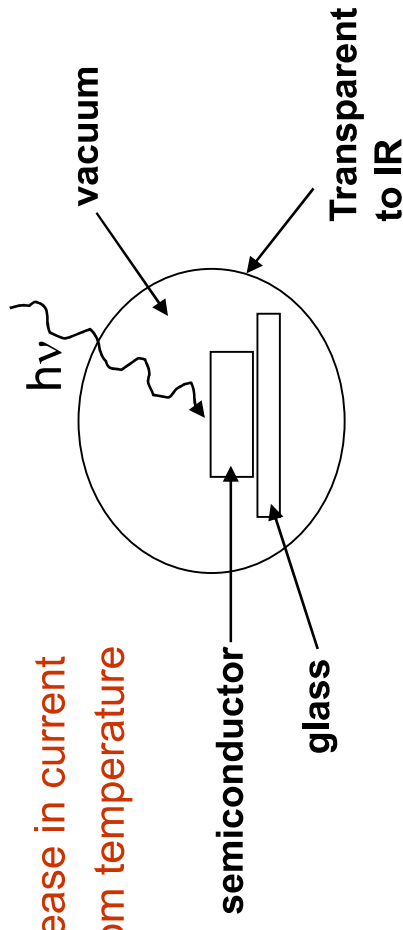

c) Pyroelectric Detectors

- pyroelectric (ceramic, lithium tantalate) material get polarized (separation of (+) and (-) charges) in presence of electric field.
- temperature dependent polarization
- measure degree of polarization related to temperature of crystal
- fast response, good for FTIR

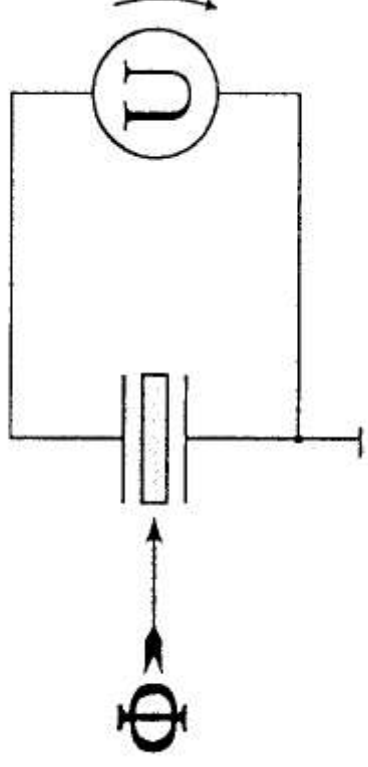

iii.) Other Components

a.) Sample Cell

- must be made of IR transparent material (KBr pellets or NaCl)

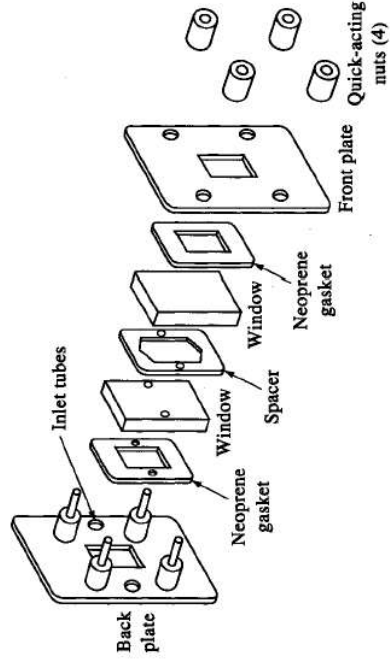

Liquid Sample Holder

NaCl plates

b.) monochromator

- reflective grating is common
- can't use glass prism, since absorbs IR

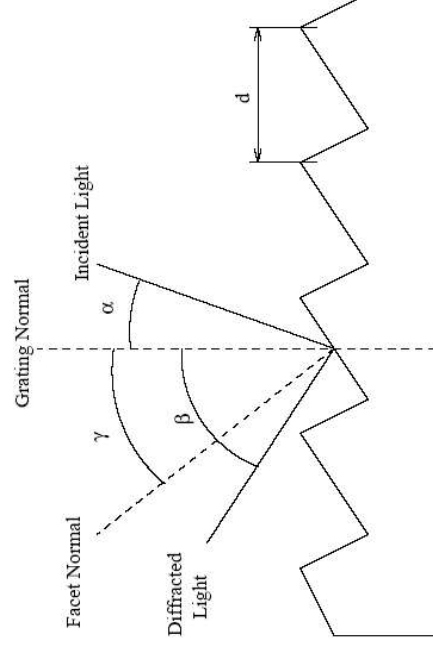

iv.) Overall Instrument Design

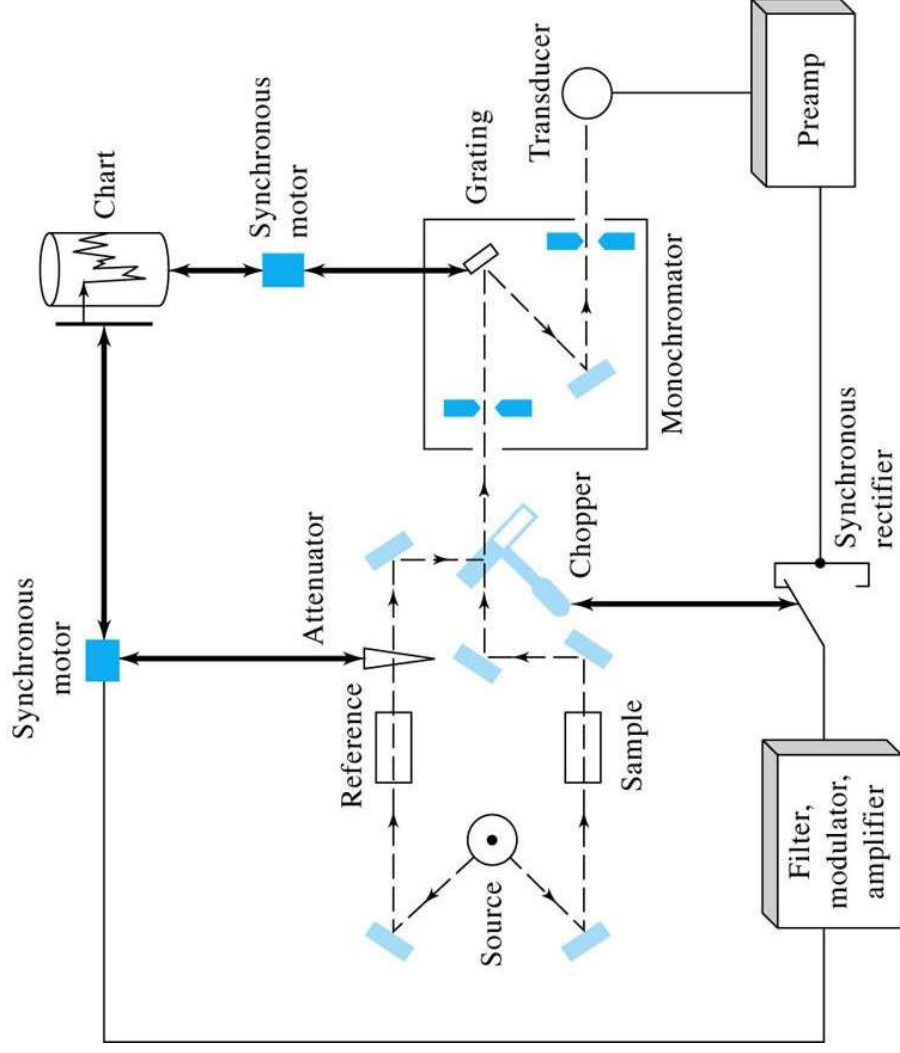

-Need chopper to discriminate source light from background IR radiation

-Monochromator after sample cell

-Not done in UV-Vis since letting in all $h\nu$ to sample may cause

photodegradation (too much energy)

-IR lower energy

-Advantage that allows

monochromator to be used to screen out more background IR light

-Problems:

-Source weak, need long scans

-Detector response slow – rounded peaks

v.) Fourier Transfer IR (FTIR) – alternative to Normal IR

- Based on **Michelson Interferometer**

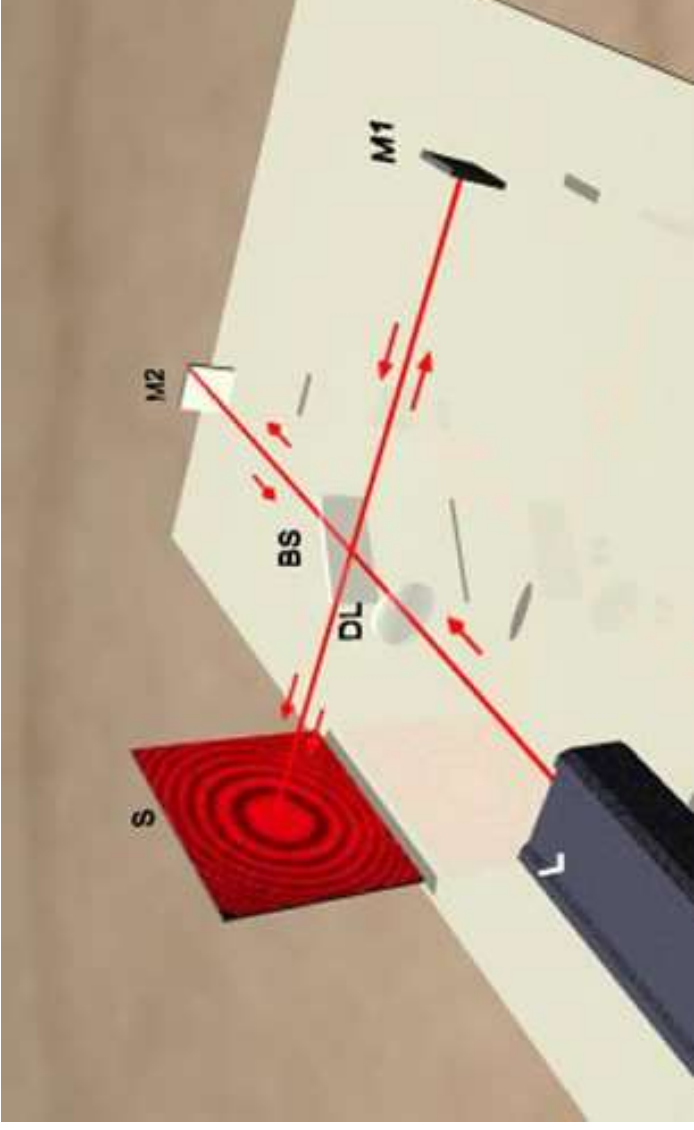

Principal:

- 1) light from source is split by central mirror into 2 beams of equal intensity
- 2) beams go to two other mirrors, reflected by central mirror, recombine and pass through sample to detector
- 3) two side mirrors. One fixed and other movable
 - a) move second mirror, light in two-paths travel different distances before recombined
 - b) constructive & destructive interference
 - c) as mirror is moved, get a change in signal

FT-IR Spectrometer

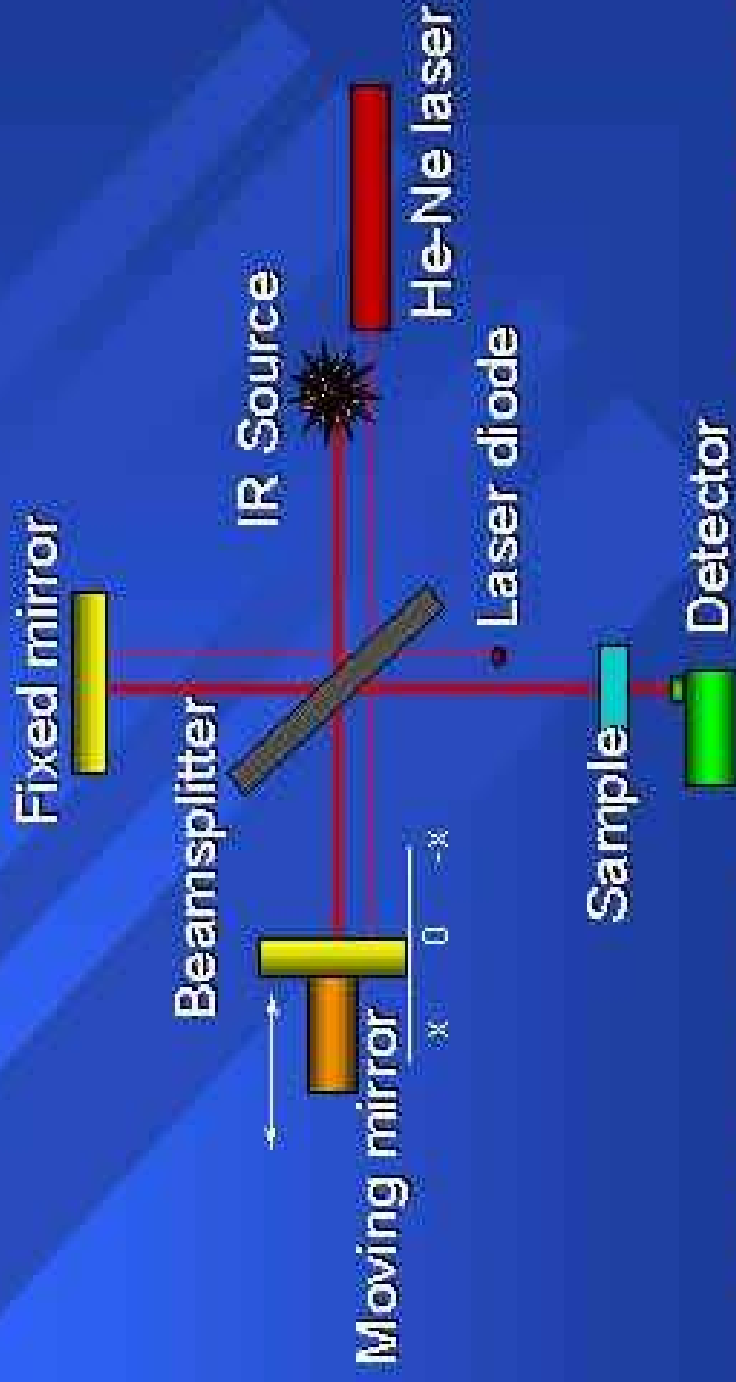

Nicolet Instrument Corporation

Spectroscopic Solutions '98

- Light enters the spectrometer and is split by the beam splitter. The figure above shows what is referred to as the Michelson interferometer

Remember

Destructive Interference can be created when two waves from the same source travel different paths to get to a point.

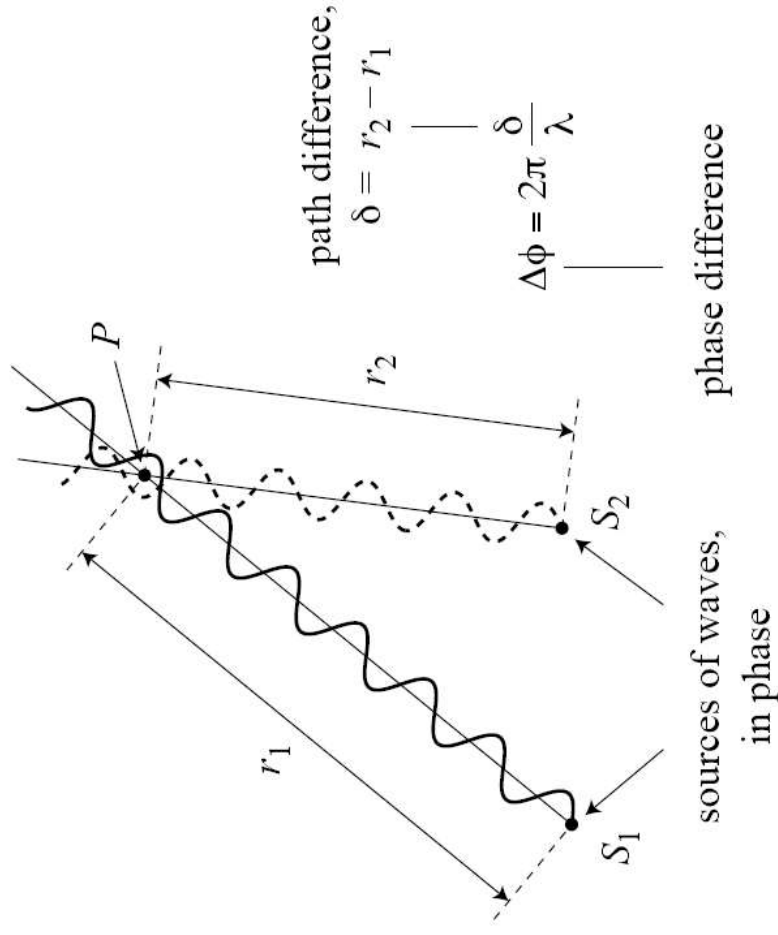

This may cause a difference in the phase between the two waves.

- *If the paths differ by an integer multiple of a wavelength, the waves will also be in phase.*
- *If the waves differ by an odd multiple of half a wave then the waves will be 180 degrees out of phase and cancel out.*

- observe a plot of Intensity vs. Distance (interferograms)
- convert to plot of Intensity vs. Frequency by doing a Fourier Transform

$$I(x) = \int_0^{\infty} B(\nu)(1 + \cos 2\pi\nu x) d\nu$$

- resolution $\Delta\nu = 1/\Delta\delta$ (interval of distance traveled by mirror)

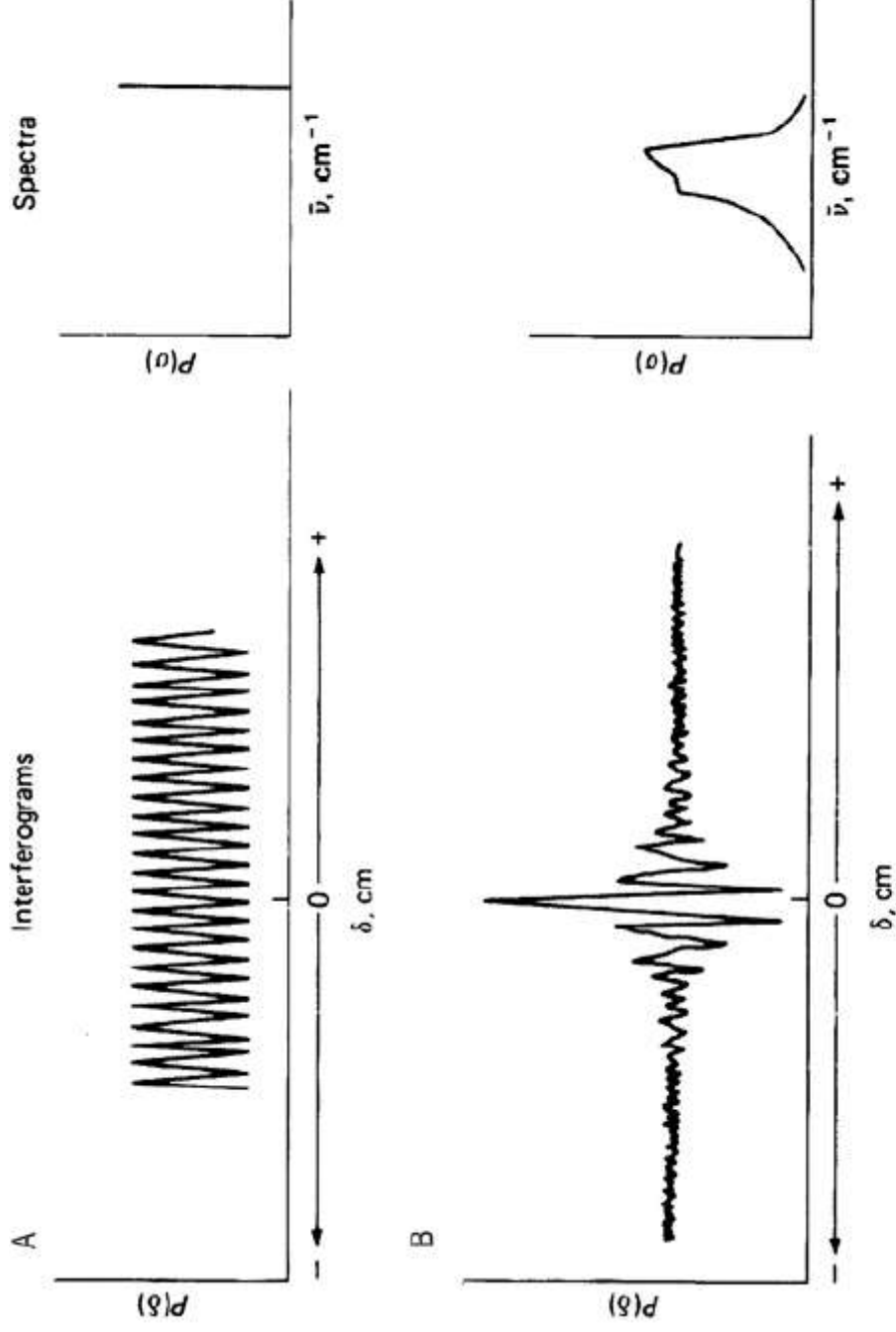

Fourier transform pairs for (A) a monochromatic source and (B) a broadband source.

Advantages of FTIR compared to Normal IR:

- 1) much faster, seconds vs. minutes
- 2) use signal averaging to increase signal-to-noise (S/N)

$$\text{increase } S / N \propto \sqrt{\text{number scans}}$$

- 3) higher inherent S/N – no slits, less optical equipment, higher light intensity
- 4) high resolution ($<0.1 \text{ cm}^{-1}$)

Disadvantages of FTIR compared to Normal IR:

- 1) single-beam, requires collecting blank
- 2) can't use thermal detectors – too slow

In normal IR, scan through frequency range. In FTIR collect all frequencies at once.

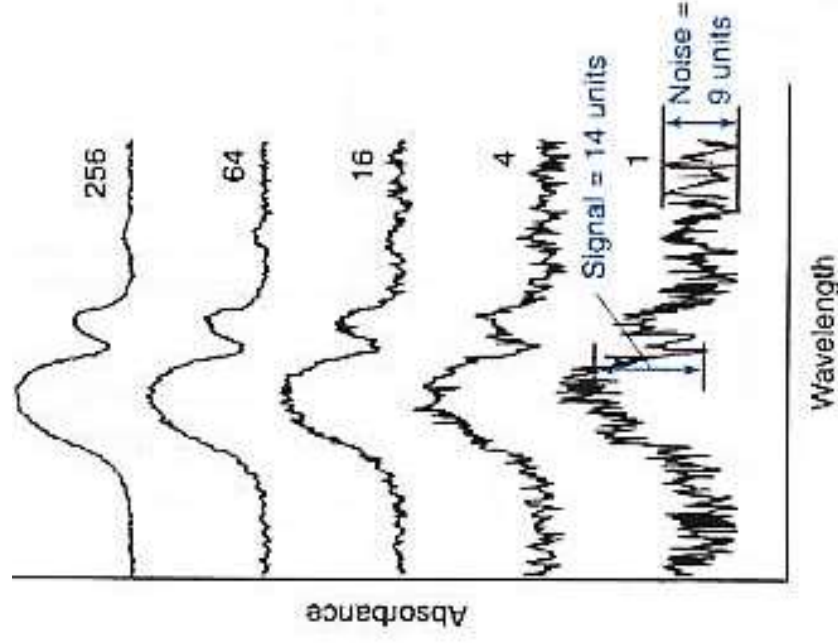

Advantages of FTIR:

Enhanced signal-to-noise

Rapid scanning

High resolution ($<0.1 \text{ cm}^{-1}$)

Accurate and reproducible frequency determinations

Larger energy throughput

Free from problems of stray radiation

D) Application of IR

1.) Qualitative Analysis (Compound Identification)

- main application
- Use of IR, with NMR and MS, in late 1950's revolutionized organic chemistry
 - ▶ decreased the time to confirm compound identification 10-1000 fold

i.) General Scheme

- 1) examine what functional groups are present by looking at group frequency region

- 3600 cm^{-1} to 1200 cm^{-1}

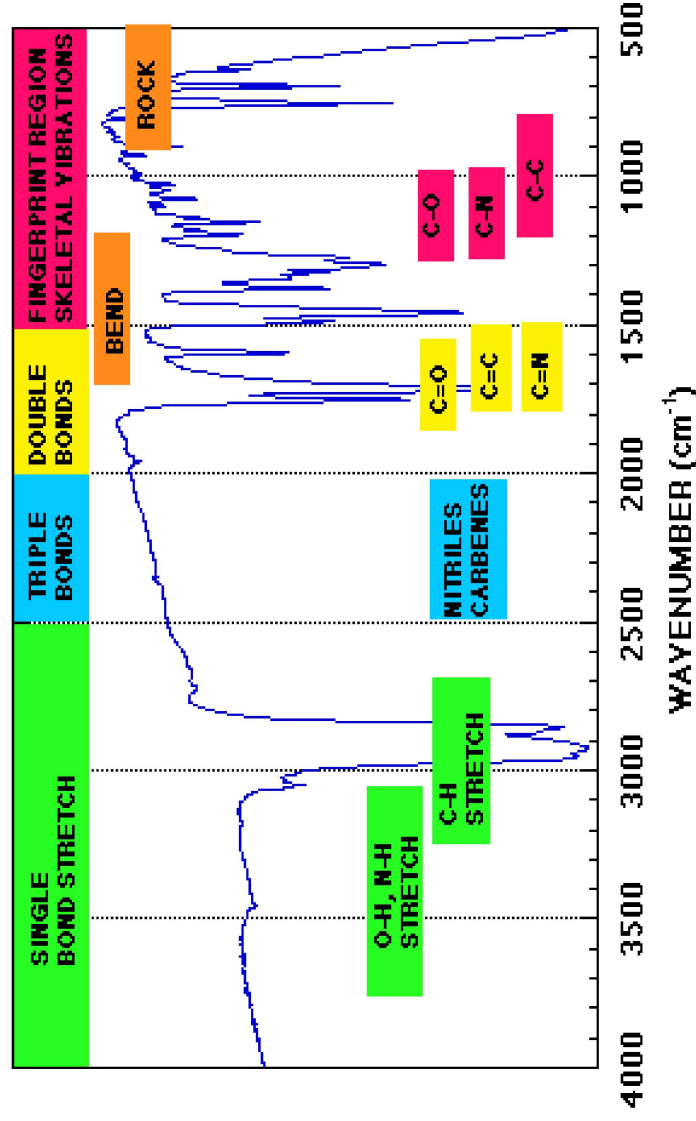

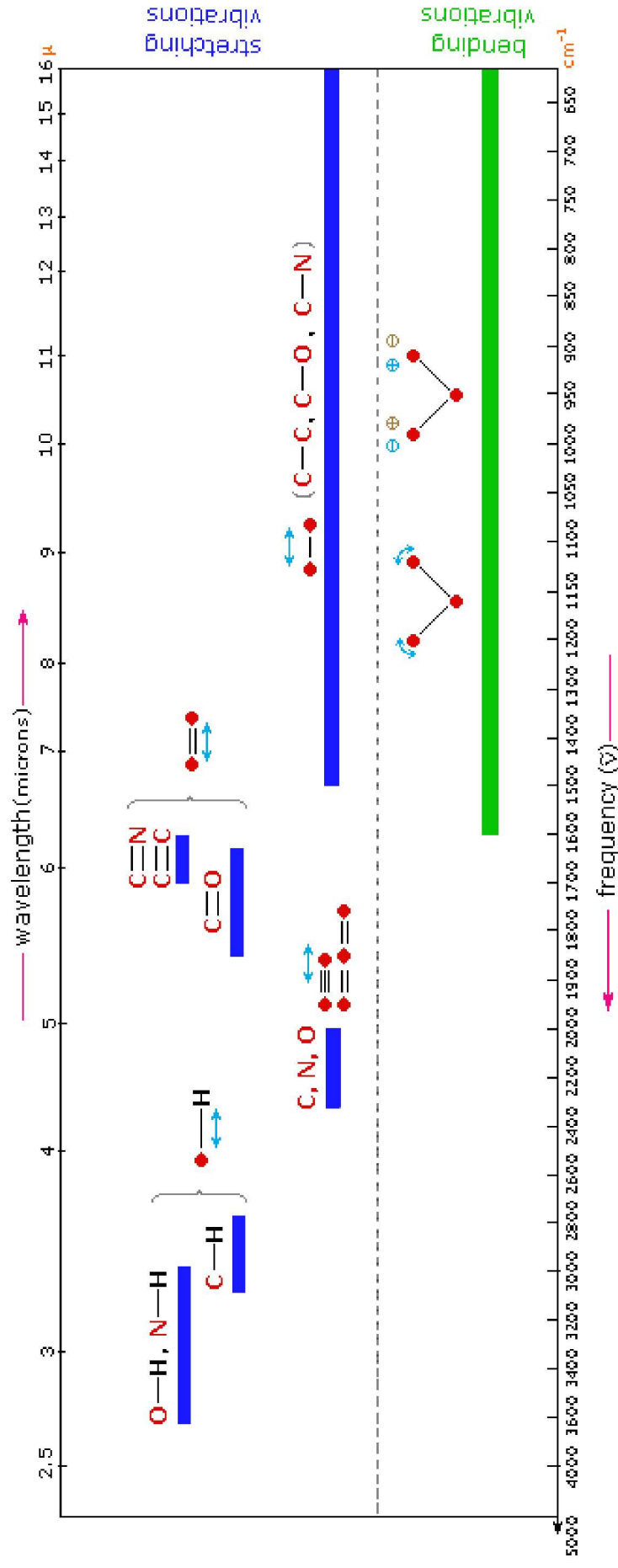

ii.) Group Frequency Region

- approximate frequency of many functional groups (C=O, C=C, C-H, O-H) can be calculated from atomic masses & force constants
- positions changes a little with neighboring atoms, but often in same general region
- serves as a good initial guide to compound identity, but not positive proof.

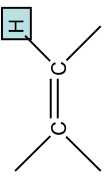

Abbreviated Table of Group Frequencies for Organic Groups

Bond	Type of Compound	Frequency Range, cm ⁻¹	Intensity
C-H	Alkanes	2850-2970	Strong
C-H	Alkenes 	3010-3095 675-995	Medium strong
C-H	Alkynes 	3300	Strong
C-H	Aromatic rings	3010-3100 690-900	Medium strong
O-H	Monomeric alcohols, phenols Hydrogen-bonded alcohols, phenols Monomeric carboxylic acids Hydrogen-bonded carboxylic acids	3590-3650 3200-3600 3500-3650 2500-2700	Variable Variable, sometimes broad Medium broad medium
N-H	Amines, amides	3300-3500	medium
C=C	Alkenes	1610-1680	Variable
C=C	Aromatic rings	1500-1600	Variable
C≡C	Alkynes	2100-2260	Variable
C-N	Amines, amides	1180-1360	Strong
C≡N	Nitriles	2210-2280	Strong
C-O	Alcohols, ethers, carboxylic acids, esters	1050-1300	Strong
C=O	Aldehydes, ketones, carboxylic acids, esters	1690-1760	Strong
NO ₂	Nitro compounds	1500-1570 1300-1370	Strong

iii.) Fingerprint Region (1200-700 cm^{-1})

- region of most single bond signals
- many have similar frequencies, so affect each other & give pattern characteristics of overall skeletal structure of a compound
- exact interpretation of this region of spectra seldom possible because of complexity
- complexity \rightarrow uniqueness

Fingerprint Region

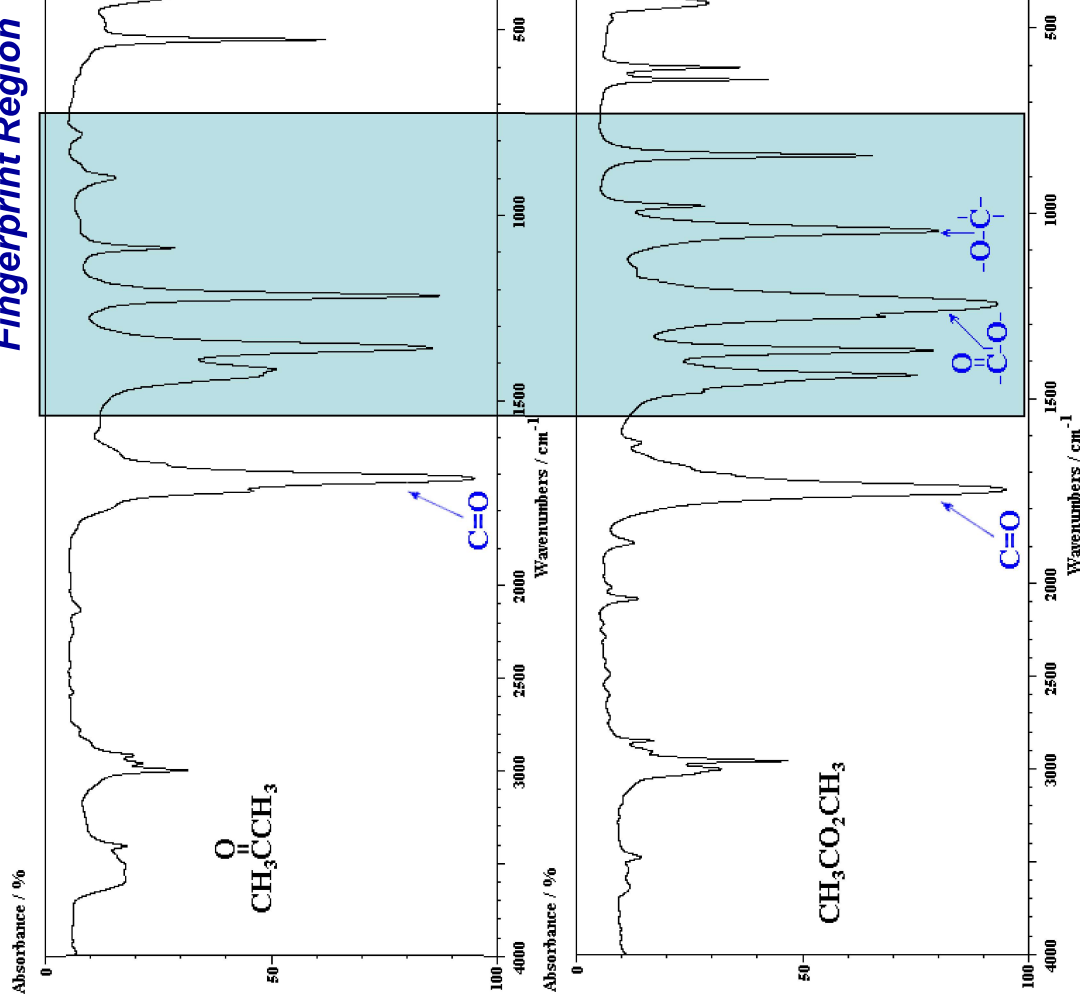

iv.) Computer Searches

- many modern instruments have reference IR spectra on file (~100,000 compounds)
- matches based on location of strongest band, then 2nd strongest band, etc
 overall skeletal structure of a compound
- exact interpretation of this region of spectra seldom possible because of complexity
- complexity → uniqueness

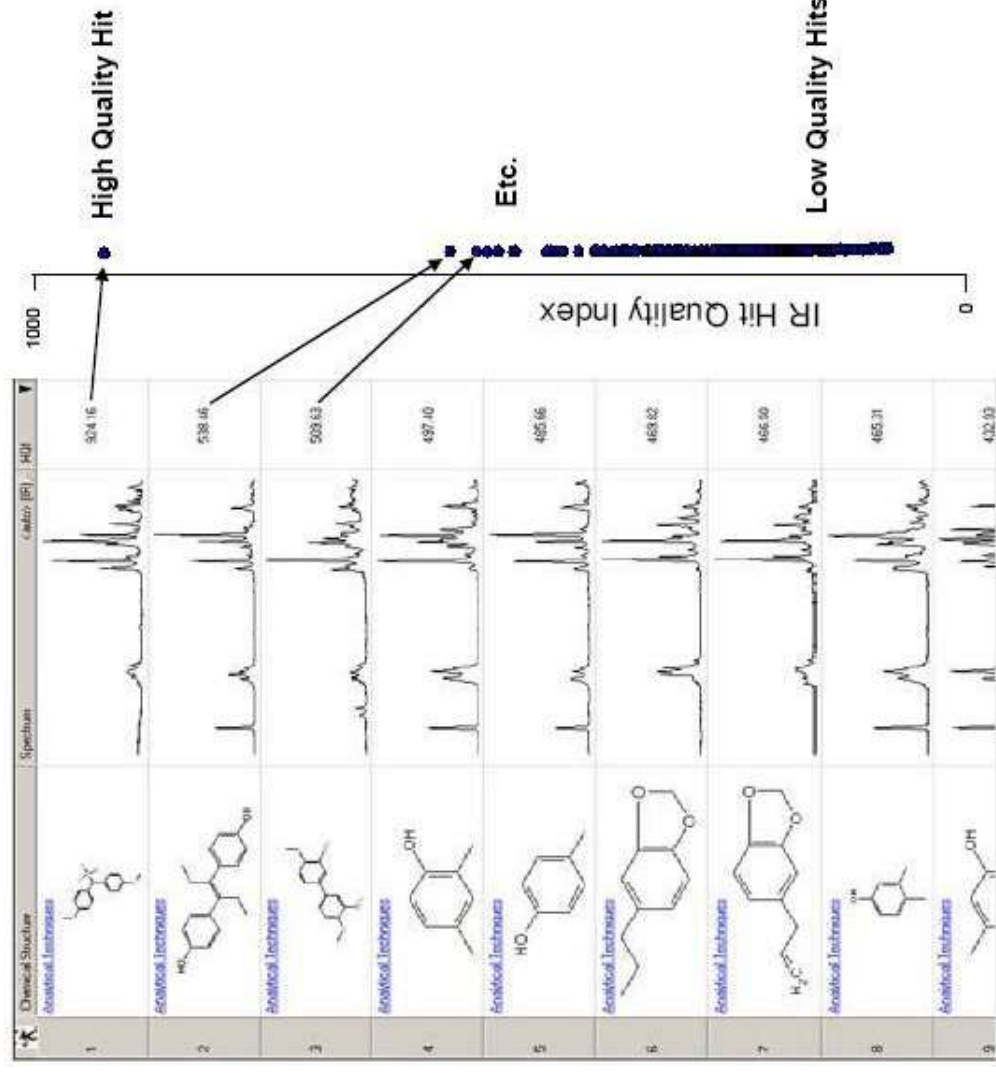

Bio-Rad SearchIT database
of ~200,000 IR spectra

2.) Quantitative Analysis

- not as good as UV/Vis in terms of accuracy and precision
 - ▶ more complex spectra
 - ▶ narrower bands (Beer's Law deviation)
 - ▶ limitations of IR instruments (lower light throughput, weaker detectors)
 - ▶ high background IR
 - ▶ difficult to match reference and sample cells
 - ▶ changes in ϵ ($A=\epsilon bc$) common
- potential advantage is good selectivity, since so many compounds have different IR spectra
 - ▶ one common application is determination of air contaminants.

Contaminants	Concn, ppm	Found, ppm	Relative error, %
Carbon Monoxide	50	49.1	1.8
Methylethyl ketone	100	98.3	1.7
Methyl alcohol	100	99.0	1.0
Ethylene oxide	50	49.9	0.2
chloroform	100	99.5	0.5

Example 9: The spectrum is for a substance with an empirical formula of C_3H_5N . What is the compound?

