

NEW AGE

A TEXTBOOK OF AGRONOMY



B. Chandrasekaran
K. Annadurai
E. Somasundaram



NEW AGE INTERNATIONAL PUBLISHERS

**A TEXTBOOK OF
AGRONOMY**

**This page
intentionally left
blank**

A TEXTBOOK OF AGRONOMY

B. Chandrasekaran

B.Sc., M.Sc. (Ag.), Ph.D.

Director of Research
Tamil Nadu Agricultural University
Coimbatore.

K. Annadurai

B.Sc., M.Sc. (Ag.), Ph.D.

Associate Professor of Agronomy
Agricultural Engineering College and
Research Institute, Kumulur
Tamil Nadu Agricultural University

E. Somasundaram

B.Sc., M.Sc. (Ag.), Ph.D.

Associate Professor of Agronomy
Agricultural Research Station
Aliyarnagar, Tamil Nadu



PUBLISHING FOR ONE WORLD

NEW AGE INTERNATIONAL (P) LIMITED, PUBLISHERS

New Delhi • Bangalore • Chennai • Cochin • Guwahati • Hyderabad
Jalandhar • Kolkata • Lucknow • Mumbai • Ranchi

Visit us at www.newagepublishers.com

Copyright © 2010, New Age International (P) Ltd., Publishers
Published by New Age International (P) Ltd., Publishers

All rights reserved.

No part of this ebook may be reproduced in any form, by photostat, microfilm, xerography, or any other means, or incorporated into any information retrieval system, electronic or mechanical, without the written permission of the publisher. *All inquiries should be emailed to rights@newagepublishers.com*

ISBN (13) : 978-81-224-2859-9

PUBLISHING FOR ONE WORLD

NEW AGE INTERNATIONAL (P) LIMITED, PUBLISHERS

4835/24, Ansari Road, Daryaganj, New Delhi - 110002

Visit us at www.newagepublishers.com



TAMILNADU AGRICULTURAL UNIVERSITY
COIMBATORE - 641 003, INDIA



Dr.C.RAMASAMY, Ph.D.
Vice-Chancellor

Phone : 0422-431222 / 2431788
Res : 0422-2430887
Fax : 0422-2431672
Grams : Farmvar
Email : vctnau@vsnl.com

Foreword

Agronomy is a science that helps to feed the world. We can call the Agronomy as backbone of all agricultural sciences, because the management of soil and water, with a view to achieving the production potential of high yielding varieties, in green revolution, is exclusively an agronomic domain. It may not be appear as glamorous as nuclear science or atomic energy working miracles but like Ayurvedic medicines, it has the capacity to reach the poorer section of the society to bring out the desired results. Agronomists can be able to synthesise production practices from several fields of specialization.

The problem of global food security remains unsolved. The increase in population means a growing demand for food in the world, whereas the essential factors in food production such as cultivated land and fresh water are decreasing continuously. Current trends on world agriculture shows that it is imperative to find a scientific and rational way to develop it, a way that can not only steadily increase the output but also ensure long term sustainable use of resources in the process of promoting agricultural development. At present, there are many comprehensive text books on Agronomy available but this is the book from which one can have at least overview of all aspects of Agronomy.

It is clear that young students are suffering from cultural shocks to shift from their environment. Semester system of education of B.Sc.(Ag.), B.Sc.(Horti.), B.Sc.(Home Science), B.Sc.(Forestry) and B.Tech.(Ag. Engg), students are quite dynamic for which the students are to be helped for changeover. We can identify their difficulties for comprehension of language, non-availability of textbooks for their semester system. There is a need to use simple language. The present book titled "A Text book of Agronomy" suite to the need of students. I am happy that the authors have made painful efforts to write this agronomy book. It covers a wide range of topics. In this connection, publication of the book "A Textbook of Agronomy" by **Dr. B. Chandrasekaran, Dr. K. Annadurai and Dr. E. Somasundaram** of TNAU, Coimbatore is quite appropriate and timely.

I expect that both the students and teachers would benefit immensely from the book contents. In particular, I expect that this book containing 17 chapters covering comprehensively the content of all courses in Agronomy for undergraduate students of B.Sc. (Ag.), B.Tech (Agrl. Engg/FPE/EEE.), B.Sc.(Forestry), B.Sc.(Home Science) and B.Sc.(Horticulture) will be a valuable reference.

The authors deserve commendation for their painful efforts and my congratulations to them. I am sure that the publication will prove to be a useful volume for students and teachers.

C. RAMASAMY
Former Vice-chancellor-TNAU
Tamilnadu Agricultural University
Coimbatore-641003 (INDIA)

**This page
intentionally left
blank**

Preface

*“Everyone has inside of him or her, a piece of good news.
The good news is, that you don’t know how great you can be!”*

— **Dr. Abdul Kalam**

The challenges before the Agricultural Scientists of our country today are much more complex than even before. Food production has to be increased to 240 m.t. within the next five years. To achieve the massive target, very little scope and possibility exist in respect of horizontal expansion. Crop production and production technologies for the same are of utmost importance for successful and economic cultivation of field crops. Under these circumstances, important and relevant informations were collected and compiled in a book form titled “**A Textbook of Agronomy**”.

This book is mainly intended for the agronomy courses of graduate students in the field of Agriculture, Horticulture, Home science, Forestry and Agricultural Engineering. It is clear that young students are suffering from cultural shocks to shift from their environment. Semester system of education of B.Sc.(Ag.), B.Sc.(Horti.), B.Sc.(Home Science), B.Sc.(Forestry) and B.Tech.(Ag. Engg.), students are quite dynamic for which the students are to be helped for changeover. We can identify their difficulties for comprehension of language, non-availability of textbooks for their semester system. There is a need to use simple language. The present book titled “A Text book of Agronomy” suite to the need of students. This book is written in simple understandable language dealing with various subject matters of agronomy. In general, the courses dealt to the graduate students are principles of agronomy, agricultural heritage of India, agricultural meteorology, principles of weed science, irrigation management, dry farming, agronomy of field crops and biofuel crops.

This book has been prepared with a specific purpose of importing complete comprehensive information about agronomy and we hope that the students and readers will find this with much utility. We thank all the authors / publishers from which references were collected on various aspects of agronomical aspects.

We are sure that this book will serve as valuable text cum reference book to the graduate students of agricultural universities.

We profusely thank **Dr. C. Ramasamy, Former Vice-Chancellor**, TNAU for his encouragement and for providing Foreword. We thank **Dr. SP. Palaniappan**, Ph.D. (Illinois), FISA (Retd., Director and Dean (Agri.), Tamil Nadu Agricultural University, Coimbatore) Natural Resource Consultant and **Dr. S. Chelliah**, Retd., Director of Research, TNAU, Coimbatore as a guiding force for our efforts.

We thank profusely **Dr. K. Alagusundaram**, National Fellow (ICAR), **Dr. P. Subbaian**, Director (ABD) Coimbatore, **Dr. S. Ramasamy**, Professor (Agronomy), **Dr. A. Velayutham**, Professor (Agronomy), **Dr. S. Sivasamy**, Professor (Soil Science and Agricultural chemistry), **Dr. N. Natarajan**, Professor (Seed Science and Technology), **Dr. C. Chinnusamy**, Professor (Agronomy), **Dr. Jeyanthi Chinnusamy**, Professor (Agronomy), **Dr. B.J. Pandian**, Professor (Agronomy), **Dr. M. Dakshinamoorthy**, Professor (SS &AC), **Dr. R. Jaganathan**, Professor and Head (Agricultural Meteorology), **Dr. A.Tajuddin**, Professor and Head (FMP and Bioenergy), Kumulur, **Dr. A. Arokiaraj**, Professor of Agronomy (Retd.), **Dr. P. Balasubramaniam** Associate Professor (SS &AC), Kumulur, **Dr. C.R. Chinnamuthu**, Associate Professor (Agronomy). **Dr. K. Sathiyamoorthi**, Professor (Agronomy) and **Dr. K. Rajamanickam**, Professor and Head, CRS, Aliyasnagar and fellow scientists of Tamil Nadu Agricultural University for their critical comments and suggestions, encouragement and support. We thank **Mrs. Kavitha** and **Mr. Ravikumar** of AEC &RI, Kumulur for their sincere efforts in typing the manuscript.

In spite of the best efforts, it is possible that some errors may have crept into the compilation. The readers are requested to kindly let us know the mistakes so that these could be taken care of in the further edition. Finally we thank our publishers for bringing out this book so efficiently and promptly.

DR. B. CHANDRASEKARAN
DR. K. ANNADURAI
DR. E. SOMASUNDARAM

Contents

<i>Foreword</i>	v
<i>Preface</i>	vii
1. An Introduction to Agriculture and Agronomy	1
1.0 An Introduction to Agriculture	1
1.1 Scope of Agriculture in India	2
1.2 Branches of Agriculture	3
1.3 Development of Scientific Agriculture	4
1.3.1 History of Agriculture	5
1.3.2 Global Agriculture	6
1.4 Agriculture in National economy	12
1.5 Food Problem in India	15
1.6 An Introduction to Agronomy	18
1.6.1 Agronomist	19
1.7 Potential Productivity and Constraints in Crop Production	20
2. Agricultural Heritage of India	22
2.1 Pangaea, the Super-continent	23
2.1.1 Geography of India	27
2.1.2 Agriculture Heritage in India	29
2.2 Development of Human Culture	30
2.2.1 Genetic History of Modern Man	30
2.2.2 Development of Human Culture	31
2.3 Technological Civilization	34
2.4 Indus Civilization	41
2.4.1 Physical Data	41
2.4.2 River Migrations in Western India	43
2.4.3 Saraswati River Civilization	44
2.4.4 Status of Farmers in Southern India	54
2.4.5 Advice by Sages to Kings	56

2.4.6	Kautilya's Arthasastra	56
2.5	Agriculture and Sangam Literature of Tamil	62
2.5.1	Sangam and its History	62
2.5.2	Tamil Literature—A Bird's View	62
2.5.2	Agriculture	64
2.5.3	Astronomy	71
2.5.4	Prediction of Monsoon Rains	74
2.6	Almanac, Panchang and Krishi-Panchang	84
2.7	Methods of Rainfall Forecasts	87
2.8	Crops	88
2.9	Origin of Crop Plants	89
2.10	History of Rice	93
2.11	History of Wheat Cultivation	94
2.12	History of Sugarcane Cultivation	94
2.13	History of Cotton Cultivation	95
2.14	Crop Production in Ancient India	95
2.14.1	Seasons	96
2.15	Planting Time and Selection of Land for Different Crops (Kasyapa)	97
2.16	Land Preparation	97
2.17	Soil as a Basic Resource for Successful Crop Production (Kashyapa)	97
2.18	The Plough and Other Implements	98
2.19	Seed Collection and Preservation	99
2.20	Crop Diversity	99
2.21	Choice of Crops and Varieties	100
2.22	Rice Varieties—Other Aspects	100
2.23	Sequence of Cropping	100
2.24	Seed and Sowing	101
2.25	Weeds and Weeding	103
2.26	Nutrient Management	103
2.27	Water Management	103
2.28	New Crops and Other Plants	104
2.29	Growth Promoters	104
2.30	Harvesting and Measuring Yields	105
2.31	Storage of Grains	105
2.32	Farming Systems	105
2.33	Soil Classification	107
2.34	Soil Types of India	108
2.35	Maintenance of Soil Productivity	110
2.36	Water Management	112
2.37	Plant Protection	119
2.38	Gardening in Ancient and Medieval Period	124
2.38.1	Arbori-Horticulture, Orchards, History and Diversity of Fruit Crops In India	126
2.38.2	Important Finds of Fruits from Archaeological Sites	129
2.38.3	The History of Gardening: A Timeline from Ancient Times to 1600	129
2.39	Vegetable Farming-Floriculture-Perfumes	130

2.39.1	Vegetable Farming	130
2.39.2	Floriculture in Ancient India	132
2.40	Perfumes	135
2.41	Medicinal Plants and Their Relevance Today	136
2.42	The Siddha System of Medicine	136
2.43	Role of Cattle and Other Domestic Animals	144
2.44	Description of Indian Civilization and Agriculture	153
2.44.1	Indus Valley Civilization	153
2.45	Our Journey in Agriculture	158
2.45.1	Vision for Agriculture in 2020 A.D.	163
3.	Crops and Crop Production	168
3.1	Classification of Crops	168
3.1.1	Range of Cultivation	168
3.1.2	Place of Origin	168
3.1.3	Botanical/Taxonomical Classification	168
3.1.4	Commercial Classification	169
3.1.5	Economic/Agrarian/Agricultural Classification	169
3.1.6	Seasonal Classification	170
3.1.7	According to Ontogeny	170
3.1.8	According to Cultural Requirements of Crops	171
3.1.9	According to Important Uses	173
3.2	Crop adaptation and Distribution	174
3.2.1	Adaptation	174
3.2.2	Principles of Plant Distribution	174
3.2.3	Theories Governing Crop Adaptation and Distribution	175
3.2.4	Major Crops of Indian Sub-continent	175
3.2.5	Factors Governing Choice of Crop and Varieties	178
3.3	Intensive Cropping	179
3.3.1	Multiple Cropping	179
3.3.2	Intercropping	179
3.3.3	Multistoried Cropping	181
3.4	Crop Rotation	181
3.5	Cropping Patterns and Cropping Systems	182
3.6	Crop Production	185
3.6.1	Factors Affecting Crop Production	185
4.	Agricultural Meteorology	200
4.1	Importance	200
4.2	Need and Scope	201
4.3	Climatology	202
4.4	Coordinates of India and Tamil Nadu	204
4.5	Atmosphere	204
4.6	Climate of India	208

xii CONTENTS

4.7	Clouds	210
4.8	Monsoon Rainfall Variability	213
4.9	Evaporation, Transpiration and Evapotranspiration	214
4.10	Hydrologic Cycle	216
4.11	Flood	217
4.12	Weather Aberrations	218
4.13	Agroclimatic Zones	220
4.14	Agroclimatic Normal	221
4.15	Weather Forecasting	223
4.16	Remote Sensing (RS)	228
4.17	Crop Weather Modeling	231
4.18	Climate Change and Variability	233
5.	Soils	238
5.1	Soil Phases	238
5.1.1	Solid Phase	240
5.1.2	Liquid Phase	241
5.1.3	Gaseous Phase	241
5.2	Properties of Soil	241
5.2.1	Physical Properties of Soil	241
5.2.2	Soil/Irrigability Classification	250
5.2.3	Soil Water or Soil Moisture	253
5.3	Soil Classification	255
5.4	Major Soils of India	255
5.4.1	Alluvial Soils (Entisols, Inceptisols and Alfisols)	255
5.4.2	Black Soils (Entisols, Inceptisols, Vertisols)	256
5.4.3	Red Soils (Alfisols, Inceptisols, Ultisols)	256
5.4.4	Laterites and Lateritic Soils (Ultisols, Oxisols, Alfisols)	257
5.4.5	Desert Soils (Aridisols, Entisols)	257
5.4.6	Tarai Soils (Mollisols)	257
5.4.7	Saline and Sodic Soils (Aridisols, Inceptisols, Alfisols, Entisols, Vertisols)	257
5.4.8	Acid Soils	258
5.5	Major Soils of Southern India – Tamil Nadu	258
5.5.1	Black Soils or Vertisol	258
5.5.2	Laterite Soils	259
5.5.3	Alluvial Soils or Entisols	259
5.5.4	Peaty Soils	259
5.5.5	Problem Soils	259
5.5.6	Alfisols	259
5.5.7	Inceptisols	259
5.5.8	Ultisols	260
5.6	Problem Soils	260
5.6.1	Saline Soils	260
5.6.2	Alkali Soil (Sodic/Solonetz)	263
5.6.3	Saline-Alkali Soils	266

5.7	Soil Productivity Constraints	267
5.7.1	Physical Constraints	267
5.7.2	Chemical Constraints	270
5.7.3	Soil Survey	276
6.	Seasons and Systems of Farming	279
6.1	Seasons	279
6.1.1	Characteristics of Seasons	280
6.1.2	Crop-wise Seasons	280
6.1.3	Agronomic Concepts of the Growing Seasons	281
6.1.4	Effect of Season on Choice of Crops	282
6.2	Systems of Farming	283
7.	Tillage	286
7.0	Definition	286
7.1	Characteristics of Good Tilth	286
7.2	Objectives	286
7.3	Types of Tilth	287
7.4	Types of Tillage	287
7.4.1	On Season Tillage	287
7.4.2	Off Season Tillage	288
7.4.3	Special Types	288
7.5	Factors Affecting (intensity and depth of) the Tillage Operations	289
7.6	Depth of Ploughing	289
7.7	Number of Ploughing	289
7.8	Time of Ploughing	290
7.9	Method of Ploughing	290
7.10	Modern Concepts of Tillage	290
7.10.1	Minimum Tillage	290
7.10.2	Zero Tillage/No Tillage/Chemical Tillage	291
7.10.3	Stubble Mulch Tillage or Stubble Mulch Farming	292
7.10.4	Conservation Tillage	292
7.11	Tillage Implements	292
7.11.1	Primary Tillage Implements	292
7.11.2	Secondary Tillage Implements	294
7.11.3	Inter Cultural Implements	296
7.11.4	Special Purpose Implements	297
8.	Seeds and Sowing	300
8.1	Characteristics	300
8.2	Advantages of using Good Quality Seeds	300
8.3	Seed Germination	301
8.4	Seed Rate	302
8.5	Seed Treatment	302

8.5.1	Methods of Seed Treatment	302
8.6	Sowing	302
8.6.1	Methods of Sowing	303
8.6.2	Factors Involved in Sowing Management	303
9.	Plant Density and Crop Geometry	305
9.1	Importance	305
9.2	Factors Affecting Plant Density	305
9.3	Crop Geometry	306
9.4	After Cultivation	307
10.	Weeds Science	308
10.1	Origin	308
10.2	Characteristics	308
10.3	Classification	311
10.3.1	Based on Morphology	311
10.3.2	Based on Life Span of Weeds	312
10.3.3	Based on Ecological Affinities	312
10.3.4	Based on Soil Type (Edaphic)	313
10.3.5	Based on Their Botanical Family	313
10.3.6	Based on Their Place of Occurrence	313
10.3.7	Based on Cotyledon Number	313
10.3.8	Based on Soil pH	313
10.3.9	Based on Origin	313
10.3.10	Based on Their Nature/on Specificity	313
10.3.11	Based on Nature of Stem	314
10.4	Weed Dissemination (dispersal of weeds)	315
10.5	Weed Ecology	315
10.6	Crop-Weed Interactions	318
10.7	Weed Control	322
10.8	Interaction of Herbicides with Moisture, Fertilizers, Bio-fertilizers, Insecticides and Fungicides	335
10.9	Integrated Weed Management (IWM)	337
10.10	Herbicide Mixtures	339
10.11	Herbicide Rotation	339
10.12	Herbicide Tolerance and Resistance	339
10.13	Herbicide Antidote	340
10.14	Safeners/Protectants	340
10.15	Adjuvants	340
10.16	Management of Herbicide Residues in Soil	341
11.	Irrigation and Water Management	343
11.1	Importance of Water	343
11.2	Importance of Irrigation Management	344

11.2	Sources of Water	346
11.2.1	Surface Water	346
11.2.2	Sub Surface Water	347
11.3	History and Statistics	347
11.4	Crop Water Requirement	351
11.4.1	Evaporation	352
11.4.2	Transpiration	353
11.4.3	Evapotranspiration or Consumptive Use	353
11.4.4	Potential Evapotranspiration (PET)	353
11.5	Irrigation Requirement	358
11.6	Effective Rainfall	360
11.7	Methods of Irrigation	361
11.7.1	Factors Influencing Irrigation Methods	361
11.7.2	Classification of Irrigation Methods	362
11.8	Irrigation Systems	377
11.8.1	Gravity Irrigation	377
11.8.2	Tank Irrigation	377
11.8.3	Lift Irrigation	378
11.9	Measurement of Irrigation Water	378
11.9.1	Methods	378
11.10	Irrigation Scheduling	386
11.11	Irrigation Management	396
11.12	Estimation of Irrigation Efficiency	397
11.13	Irrigation Management Under Limited Water Supply	400
11.14	Water Management in Problem Soils	403
11.15	Management of Poor Quality Water for Irrigation	405
11.16	Drainage	407
11.17	Irrigation Management in Command Areas	411
11.18	Irrigation Management under Limited Water Supply	413
11.19	Water Relations of Soil	414
11.20	Movement of Water into Soils	414
11.20.1	Water Movement in Soil Profile	415
11.20.2	Water Movement in Unsaturated Condition	416
11.21	Water Vapour Movement	416
11.22	Soil Moisture Constants	417
11.22.1	Saturation	418
11.22.2	Field Capacity	418
11.22.3	Permanent Wilting Point	418
11.22.4	Available Soil Moisture	418
11.22.5	Moisture Equivalent	420
11.22.6	Hydraulic Conductivity	420
11.23	Estimation of Soil Moisture Constants	421
11.24	Moisture Extraction Pattern of Crops	422
11.25	Water Movement in Soil-Plant-Atmospheric System	423
11.26	Soil Moisture Estimation	426

11.26.1 Estimation of Soil Moisture by Gravimetric Method	427
11.26.2 Resistance Block	428
11.27 Soil Moisture Stress	430
12. Nutrient Management	432
12.1 Classification of Essential Elements	433
12.1.1 Based on the Relative Quantity that is Normally Present in Plants	433
12.1.2 Based on Their Chemical Nature	433
12.1.3 Based on General Function	433
12.1.4 Based on the Mobility in Plants	433
12.2 Nutrients–Role, Deficiency, Method of Control and Toxicity	434
12.3 Nutrient Deficiency Symptoms	436
12.4 Organic Manures	437
12.4.1 Bulky Organic Manures	437
12.4.2 Concentrated Organic Manures	439
12.4.3 Green Manure and Green Leaf Manure	440
12.5 Fertilizers	443
12.5.1 Classification	443
12.6 Bio Fertilizers	446
12.7 Factors Affecting Manures and Fertilizers Use	448
12.8 Time of Application	449
12.8.1 Method of Application	449
12.9 Integrated Nutrient Management (INM)	450
13. Dry Land Agriculture	455
13.1 Introduction	455
13.2 Indian Agriculture-Scenario	457
13.3 Dry Farming in India	461
13.4 Aridity and Drought	469
13.5 Soil Moisture Constraints	474
13.5.1 Methods of Soil Moisture Conservation	475
13.6 Climatological Approach for Crop Planning	490
13.7 Soil Fertility Management under Dry Farming	495
13.8 Contingency Crop Planning for Different Aberrant Weather Situations	499
13.9 Resource Management for Sustainable Agriculture	501
13.10 Alternate Land Use System	504
13.11 Watershed Development	506
14. Harvesting and Post Harvest Technology	511
14.1 Harvesting	511
15. Agronomy of Field Crops and Biofuel Plants	520
15.1 Cereals–Major	520

15.2	Minor Cereals	552
15.3	Millets	557
15.4	Small/Minor Millets	570
15.5	Pulses	573
15.6	Oil Seed Crops	586
15.7	Oil Seeds–Minor	599
15.8	Sugar Crops	609
15.9	Narcotics	614
15.10	Fibre Crops–Major	618
15.11	Fibre Crops–Minor	624
15.12	Bio Fuel Plants	627
15.13	Green Manures and Green Leaf Manures	632
15.14	Forage Crops and Grasses	650
	15.14.1 Forage Crops	652
	15.14.2 Pasture Management	662
	15.14.3 Silage Making	665
16.	Cropping System and Farming System	667
16.1	Cropping System	667
16.2	Efficient Cropping Zones	669
16.3	Major Cropping Systems	671
16.3	Types of Cropping Systems	674
	16.3.1 Intercropping	675
	16.3.2 Fallowing	679
16.4	Integrated Farming Systems	679
	16.4.1 Present Research Thrust and Its Limitations	680
	16.4.2 Definition	680
	16.4.3 Development	681
	16.4.4 Characteristics of an Improved Farming System	682
16.5	Models for Different Agro-Eco Systems	683
	16.5.1 Integrated Farming System for Wet Land	683
	16.5.2 Integrated Farming System for Irrigated Upland	687
	16.5.3 Integrated Farming System for Dry Land	688
17.	Sustainable Agriculture	690
17.1	Indian Agriculture Before the Green Revolution	691
17.2	The Green Revolution	691
	17.2.1 Impact of Green Revolution on the Environment	692
17.3	Sustainable Agriculture	694
	17.3.1 Role	695
	17.3.2 Concepts and Basic Principles	696
	17.3.3 Sustainability Through Farming Systems	699
17.4	Indices of Sustainability	712
	17.4.1 Sustainability Coefficient (SC)	713

17.4.2	Crop Productivity as an Indicator of Sustainability	713
17.5	Input management for Sustainable Agricultural Systems	714
17.5.1	Optimizing Nutrient Availability	714
17.5.2	Micronutrient Deficiencies	715
17.5.3	Limiting Nutrient Losses	715
17.5.4	Use of Chemical Fertilizers	715
17.5.5	Nutrient Recycling	715
17.5.6	Use of Crop Residues	715
17.5.7	Biological Nitrogen Fixation	716
17.5.8	Use of Biofertilizers	717
17.5.9	Green Manuring	717
Annexures		718
Annexures-1	Units Related to Crop Production	718
Annexure-1A	Conversion Factors between Important Primary and Secondary Agricultural Commodities	719
Annexure-2	List of Crops—Common and Botanical Names	721
Annexure-3	Efficient Cropping Systems for Different Agro-Climatic Zones of India	726
Annexure-4	List of Major Weeds in the World and India	728
Annexure-5	Most Common Weeds in Crop Fields of India	729
Annexure-6	Contribution of Agriculture to National Income	730
Annexure-7	National Institutions for Agricultural Research	731
Annexure-8	International Institutions for Agricultural Research	733
Annexure-9	Selected Indicators of Agriculture Development in India, Asia-Pacific Region and the World, 1994 and 2003	734
Annexure-10	India's Position in World Agriculture in 2003	735
Appendix-11	Production and Productivity in Agriculture During Past 50 Years	737
Annexure-12	Tamil Nadu Basic Statistics	738
Annexure-13	Area, Production and Productivity of Principal Crops in Tamil Nadu (2004–05)	742
Annexure-14	Area Under Principal Crops by Districts (2004–05) in Tamil Nadu (in ha)	743
Annexure-15	Time Series Data Area of Important Crops in Tamil Nadu ('000 ha)	747
Annexure-16	Area and Production of Rice, Sorghum and Cumbu in Tamil Nadu-district wise (2004–2005)	748
Annexure-17	Area and Production of Maize and Ragi in Tamil Nadu-district wise (2004–05)	749
Annexure-18	Area of Bengal Gram, Red Gram and Green Gram in Tamil Nadu –district wise (2004–2005) in ha	750
Annexure-19	Area and Production of Sugarcane and Cotton in Tamil Nadu-district wise (2004–2005)	751
Annexure-20	Area and Production of Groundnut, Gingelly and Area of Castor in Tamil Nadu-district wise (2004–2005)	752
Annexure-21	Three Largest Producing States of Important Crops during 2005–06	753

Annexure-22	Area, Production and Yield of Principal Crops in various Countries in 2003	755
Annexure-23	All-India Area, Production and Yield of Rice from 1950–51 to 2005–06	758
Annexure-24	Area, Production and Yield of Rice during 2004–05 and 2005–06 in major rice Producing States	760
Annexure-25	All-India Area, Production and Yield of Wheat from 1950–51 to 2005–06	761
Annexure-26	Area, Production and Yield of Wheat during 2004–05 and 2005–06 in major Wheat Producing States	763
Annexure-27	All-India Area, Production and Yield of Jowar from 1950–51 to 2005–06 along with percentage coverage under irrigation	764
Annexure-28	Area, Production and Yield of Jowar during 2004–05 and 2005–06 in Major Jowar producing States along with coverage under Irrigation	766
Annexure-29	All-India Area, Production and Yield of Bajra from 1950–51 to 2005–06 along with Percentage Coverage under Irrigation	767
Annexure-30	All-India Area, Production and Yield of Maize from 1950–51 to 2005–06 along with percentage coverage under irrigation	769
Annexure-31	Area, Production and Yield of Maize during 2004–05 and 2005–06 in major Maize Growing States	772
Annexure-32	All-India Area, Production and Yield of total Pulses from 1950–51 to 2005–06 along with percentage coverage under irrigation	773
Annexure-33	Area, Production and Yield of total Pulses during 2004–05 and 2005–06 in major pulses growing states	775
Annexure-34	All-India Area, Production and Yield of Groundnut from 1950–51 to 2005–06 along with percentage coverage under Irrigation	775
Annexure-35	Area, Production and Yield of Groundnut during 2004–05 and 2005–06 in major Groundnut Producing States	777
Annexure-36	All-India Area, Production and Yield of Rapeseed and Mustard from 1950–51 to 2005–06 along with percentage coverage under Irrigation	778
Annexure-37	Area, Production and Yield of Rapeseed and Mustard during 2004–05 and 2005–06 in major rapeseed and Mustard Producing States	780
Annexure-38	All-India Area, Production and Yield of Soyabean from 1970–71 to 2005–06	781
Annexure-39	Area, Production and Yield of Soyabean during 2004–05 and 2005–06 in major Soyabean Producing States	782
Annexure-40	All-India Area, Production and Yield of Sunflower from 1970–71 to 2005–06	783
Annexure-41	Area, Production and Yield of Sunflower during 2004–05 and 2005–06 in major Sunflower Producing States	784
Annexure-42	All-India Area, Production and Yield of Cotton from 1950–51 to 2005–06 along with percentage coverage under irrigation	785
Annexure-43	Area, Production and Yield of Cotton during 2004–05 and 2005–06 in major Cotton Producing States	787
Annexure-44	All-India Area, Production and Yield of Jute and Mesta from 1950–51 to 2005–06	788

xx CONTENTS

Annexure-45	Area, Production and Yield of Jute and Mesta during 2004–05 and 2005–06 in respect of major jute and Mesta Producing States	790
Annexure-46	All-India Area, Production and Yield of Sugarcane from 1950–51 to 2005–06 along with percentage coverage under irrigation	791
Annexure-47	Area, Production and Yield of Sugarcane during 2004–05 and 2005–06 in major Sugarcane Producing States	793
Acronyms		795
Glossary		804
For Further Reading		821
Selected References		826
Index		829

An Introduction to Agriculture and Agronomy

Agriculture helps to meet the basic needs of human and their civilization by providing food, clothing, shelters, medicine and recreation. Hence, agriculture is the most important enterprise in the world. It is a productive unit where the free gifts of nature namely land, light, air, temperature and rain water etc., are integrated into single *primary unit* indispensable for human beings. *Secondary productive units* namely animals including livestock, birds and insects, feed on these primary units and provide concentrated products such as meat, milk, wool, eggs, honey, silk and lac.

Agriculture provides food, feed, fibre, fuel, furniture, raw materials and materials for and from factories; provides a free fare and fresh environment, abundant food for driving out famine; favours friendship by eliminating fights. Satisfactory agricultural production brings peace, prosperity, harmony, health and wealth to individuals of a nation by driving away distrust, discord and anarchy. It helps to elevate the community consisting of different castes and classes, thus it leads to a better social, cultural, political and economical life. Agricultural development is multidirectional having galloping speed and rapid spread with respect to time and space. After green revolution, farmers started using improved cultural practices and agricultural inputs in intensive cropping systems with labourer intensive programmes to enhance the production potential per unit land, time and input. It provided suitable environment to all these improved genotypes to foster and manifest their yield potential in newer areas and seasons. Agriculture consists of growing plants and rearing animals in order to yield, produce and thus it helps to maintain a biological equilibrium in nature.

1.0 AN INTRODUCTION TO AGRICULTURE

A. Terminology

Agriculture is derived from Latin words *Ager* and *Cultura*. *Ager* means land or field and *Cultura* means cultivation. Therefore the term agriculture means cultivation of land. *i.e.*, the science and art of producing crops and livestock for economic purposes. It is also referred as the science of producing crops and livestock from the natural resources of the earth. The primary aim of agriculture is to cause the land to produce more abundantly, and at the same time, to protect it from deterioration and misuse. It is synonymous with farming—the production of food, fodder and other industrial materials.

B. Definitions

Agriculture is defined in the Agriculture Act 1947, as including ‘horticulture, fruit growing, seed growing, dairy farming and livestock breeding and keeping, the use of land as grazing land, meadow

land, osier land, market gardens and nursery grounds, and the use of land for woodlands where that use ancillary to the farming of land for Agricultural purposes”. It is also defined as ‘purposeful work through which elements in nature are harnessed to produce plants and animals to meet the human needs. It is a biological production process, which depends on the growth and development of selected plants and animals within the local environment.

C. Agriculture as art, science and business of crop production

Agriculture is defined as the art, the science and the business of producing crops and the livestock for economic purposes.

As an art, it embraces knowledge of the way to perform the operations of the farm in a skillful manner. The skill is categorized as;

Physical skill: It involves the ability and capacity to carry out the operation in an efficient way for e.g., handling of farm implements, animals etc., sowing of seeds, fertilizer and pesticides application etc.

Mental skill: The farmer is able to take a decision based on experience, such as (i) time and method of ploughing, (ii) selection of crop and cropping system to suit soil and climate, (iii) adopting improved farm practices etc.

As a science : It utilizes all modern technologies developed on scientific principles such as crop improvement/breeding, crop production, crop protection, economics etc., to maximize the yield and profit. For example, new crops and varieties developed by hybridization, transgenic crop varieties resistant to pests and diseases, hybrids in each crop, high fertilizer responsive varieties, water management, herbicides to control weeds, use of bio-control agents to combat pest and diseases etc.

As the business : As long as agriculture is the way of life of the rural population, production is ultimately bound to consumption. But agriculture as a business aims at maximum net return through the management of land, labour, water and capital, employing the knowledge of various sciences for production of food, feed, fibre and fuel. In recent years, agriculture is commercialized to run as a business through mechanization.

1.1 SCOPE OF AGRICULTURE IN INDIA

In India, population pressure is increasing while area under cultivation is static (as shown in the land utilization statistics given below) or even shrinking, which demand intensification of cropping and allied activities in two dimensions *i.e.*, time and space dimension. India is endowed with tropical climate with abundant solar energy throughout the year, which favours growing crops round the year. There is a vast scope to increase irrigation potential by river projects and minor irrigation projects. In addition to the above, India is blessed with more labourer availability. Since agriculture is the primary sector, other sectors are dependent on agriculture.

Total geographical area	:	328.848 million ha.
Total reporting area	:	304.300 million ha.
Area under cultivation	:	143.000 million ha.
Total cropped area	:	179.750 million ha.
Area sown more than once	:	36.750 million ha.
Area not available for cultivation	:	161.300 million ha.
Area under forest	:	66.400 million ha.

In India, major allocation has been done in each five-year plan to agriculture. In 8th five-year plan, nearly 23% of the national budget allocation goes to agriculture and allied agro-based cottage industries run on small scales. More than 60% of the Indian population (60 millions/1.05 billion) depends or involved in agriculture and allied activities. Nearly 40% of the net national product is from agricultural sector. Approximately 35% employment is generated from agriculture, out of which 75% is found in rural areas either directly or indirectly.

In India, food grain production increased almost four folds from about 50 million tones at independence to more than 220 million tones in 2005 through *green revolution*. Despite variation in the performance of individual crops and regions, total food grain production maintained a growth of 2.7% per annum, which kept ahead of population growth at about 2.2% per annum. Through *white revolution*, milk production increased from 17 million tones at independence to 69 million tones (1997–98). Through *blue revolution*, fish production rose from 0.75 million tones to nearly 5.0 million tones during the last five decades. Through *yellow revolution*, oil seed production increased 5 times (from 5 million tones to 25 million tones) since independence. Similarly, the egg production increased from 2 billion at independence to 28 billion, sugarcane production from 57 million tones to 276 million tones, cotton production from 3 million bales to 14 million bales which shows our sign of progress. India is the largest producer of fruits in the world. India is the second largest producer of milk and vegetables.

In future, agriculture development in India would be guided not only by the compulsion of improving food and nutritional security, but also by the concerns for environmental protection, sustainability and profitability. By following the General Agreement on Trade and Tariff (GATT) and the liberalization process, globalization of markets would call for competitiveness and efficiency of agricultural production. Agriculture will face challenging situations on the ecological, global climate, economic equity, energy and employment fronts in the years to come.

1.2 BRANCHES OF AGRICULTURE

Agriculture has 3 main spheres viz., Geoponic (Cultivation in earth-soil), Aeroponic (cultivation in air) and Hydroponic (cultivation in water). Agriculture is the branch of science encompassing the applied aspects of basic sciences. The applied aspects of agricultural science consists of study of field crops and their management (**Arviculture**) including soil management.

Crop production - It deals with the production of various crops, which includes food crops, fodder crops, fibre crops, sugar, oil seeds, etc. It includes agronomy, soil science, entomology, pathology, microbiology, etc. The aim is to have better food production and how to control the diseases.

Horticulture - Branch of agriculture deals with the production of flowers, fruits, vegetables, ornamental plants, spices, condiments (includes narcotic crops-opium, etc., which has medicinal value) and beverages.

Agricultural Engineering - It is an important component for crop production and horticulture particularly to provide tools and implements. It is aiming to produce modified tools to facilitate proper animal husbandry and crop production tools, implements and machinery in animal production.

Forestry - It deals with production of large scale cultivation of perennial trees for supplying wood, timber, rubber, etc. and also raw materials for industries.

Animal Husbandry - The animals being produced, maintained, etc. Maintenance of various types of livestock for direct energy (work energy). Husbandry is common for both crop and animals. The objective is to get maximum output by feeding, rearing, etc. The arrangement of crops is done to get

minimum requirement of light or air. This arrangement is called geometry. Husbandry is for direct and indirect energy.

Fishery Science - It is for marine fish and inland fishes including shrimps and prawns.

Home Science - Application and utilization of agricultural produces in a better manner. When utilization is enhanced production is also enhanced. *e.g.*, a crop once in use in south was found that it had many uses now.

On integration, all the seven branches, first three is grouped as for crop production group and next two for animal management and last two as allied agriculture branches. Broadly in practice, agriculture is grouped in four major categories as,

A. Crop Improvement	(i) Plant breeding and genetics (ii) Bio-technology
B. Crop Management	(i) Agronomy (ii) Soil Science and Agricultural Chemistry (iii) Seed technology (iv) Agricultural Microbiology (v) Crop-Physiology (vi) Agricultural Engineering (vii) Environmental Sciences (viii) Agricultural Meteorology
C. Crop Protection	(i) Agricultural Entomology (ii) Plant Pathology (iii) Nematology
D. Social Sciences	(i) Agricultural Extension (ii) Agricultural Economics
Allied disciplines	(i) Agricultural Statistics (ii) English and Tamil (iii) Mathematics (iv) Bio-Chemistry etc.

1.3 DEVELOPMENT OF SCIENTIFIC AGRICULTURE

Early man depended on hunting, fishing and food gathering. To this day, some groups still pursue this simple way of life and others have continued as roving herdsmen. However, as various groups of men undertook deliberate cultivation of wild plants and domestication of wild animals, agriculture came into being. Cultivation of crops, notably grains such as wheat, rice, barley and millets, encouraged settlement of stable farm communities, some of which grew into a town or city in various parts of the world. Early agricultural implements-digging stick, hoe, scythe and plough-developed slowly over the centuries and each innovation caused profound changes in human life. From early times too, men created indigenous systems of irrigation especially in semi-arid areas and regions of periodic rainfall.

Farming was intimately associated with landholding and therefore with political organization. Growth of large estates involved the use of slaves and bound or semi-free labourers. As the Middle Ages wanted increasing communications, the commercial revolution and the steady rise of cities in Western Europe tended to turn agriculture away from subsistence farming towards the growing of crops for sale

outside the community *i.e.*, commercial agricultural revolution. Exploration and intercontinental trade as well as scientific investigations led to the development of agricultural knowledge of various crops and the exchange of mechanical devices such as the sugar mill and Eli Whitney's cotton gin helped to support the system of large plantations based on a single crop.

The industrial revolution, after the late 18th century, swelled the population of towns and cities and increasingly forced agriculture into greater integration with general economic and financial patterns. The era of mechanized agriculture began with the invention of such farm machines as the reaper, cultivator, thresher, combine harvesters and tractors, which continued to appear over the years leading to a new type of large scale agriculture. Modern science has also revolutionized food processing. Breeding programmes have developed highly specialized animal, plant and poultry varieties thus increasing production efficiency greatly. All over the world, agricultural colleges and government agencies attempt to increase output by disseminating knowledge of improved agricultural practices through the release of new plant and animal types and by continuous intensive research into basic and applied scientific principles relating to agricultural production and economics.

1.3.1 History of Agriculture

Excavations, legends and remote sensing tests reveal that agriculture is 10,000 years old. Women by their intrinsic insight first observed that plants come up from seeds. Men concentrated on hunting and gathering (Paleolithic and Neolithic periods) during that time. Women were the pioneers for cultivating useful plants from the wild flora. They dug out edible roots and rhizomes and buried the small ones for subsequent harvests. They used animal meat as main food and their skin for clothing. The following Table 1.1 gives an idea about agriculture development scenario.

Table 1.1. Agriculture Development Scenario

<i>Agricultural System</i>	<i>Cultural stage or Time</i>	<i>Average cereal yield (t/ha)</i>	<i>World population (millions)</i>	<i>Per capita land availability (ha)</i>
Hunting and Gathering	Paleolithic	–	7	–
Shifting Agriculture	Neolithic (about 7,000 B.C.)	1	35	40.00
Medieval Agriculture	500–1450 A.D.	1	900	01.50
Livestock farming	18th Century	2	1800	00.70
Fertilizer/Pesticide in Agriculture	20th Century	4	4200	00.30

A. Shifting Cultivation

A primitive form of agriculture in which people working with the crudest of tools, cut down a part of the forest, burnt the underneath growth and started new garden sites. After few years, when these plots lost their fertility or became heavily infested with weeds or soil-borne pests, they shifted to a new site. This is also known as **Assartage system** (cultivating crops till the land is completely worn-out) contrary to the fallow system. Fallow system means land is allowed for a resting period without any crop. In India, shifting cultivation existed in different states, with different names as *jhum* cultivation in Assam, *podu* in Andhra Pradesh and Orissa, *kumari* in Western Ghats, *walra* in south east Rajasthan, *penda bewar* in Madhya Pradesh and *slash and burn* in Bihar.

B. Subsidiary Farming

Rudimentary system of settled farming, which includes cultivation, gathering and hunting. People in groups started settling down near a stream or river as permanent village sites and started cultivating in the same land more continuously, however the tools, crops and cropping methods were primitive.

C. Subsistence Farming

Advanced form of primitive agriculture *i.e.*, agriculture is considered as a way of life based on the principle of “Grow it and eat it” instead of growing crops on a commercial basis. Hence, it is referred as raising the crops only for family needs.

D. Mixed Farming

It is the farming comprising of crop and animal components. Field crop-grass husbandry (same field was used both for cropping and later grazing) was common. It is a stage changing from food gathering to food growing.

E. Advanced Farming

Advanced farming practices includes selection of crops and varieties, seed selection, green manuring with legumes, crop rotation, use of animal and crop refuse as manures, irrigation, pasture management, rearing of milch animals, bullocks, sheep and goat for wool and meat, rearing of birds by stall feeding etc.

F. Scientific Agriculture (19th Century)

During 18th century, modern agriculture was started with crop sequence, organic recycling, introduction of exotic crops and animals, use of farm implements in agriculture etc. During 19th century, research and development (R&D) in fundamental and basic sciences were brought under applied aspects of agriculture. Agriculture took the shape of a teaching science. Laboratories, farms, research stations, research centres, institutes for research, teaching and extension (training and demonstration) were developed. Books, journals, popular and scientific articles, literatures were introduced. New media, and audio-visual aids were developed to disseminate new research findings and information to the rural masses.

G. Present Day Agriculture (21st Century)

Today agriculture is not merely production oriented but is becoming a business consisting of various enterprises like livestock (dairy), poultry, fishery, piggery, sericulture, apiary, plantation cropping etc.

Now, a lot of developments on hydrological, mechanical, chemical, genetical and technological aspects of agriculture are in progress. Governments are apportioning a greater share of national budget for agricultural development. Small and marginal farmers are being supplied with agricultural inputs on subsidy. Policies for preserving, processing, pricing, marketing, distributing, consuming, exporting and importing are strengthening. Agro-based small scale industries and crafts are fast developing. Need based agricultural planning, programming and execution are in progress.

1.3.2 Global Agriculture

Advancement of civilization is closely related to agriculture, which produces food to satisfy hunger. The present food production must double to maintain the status quo. However, nearly one billion people are living below poverty line and civilized society should ensure food for these people. Some allowance should be made for increased consumption as a consequence of raising incomes in third world countries. Therefore, the increased food production should aim at trebling food production in the next century.

<i>Year</i>	<i>Development in agriculture</i>
70 million years ago	Trees evolved
40 million years ago	Monkeys and apes evolved
10 million years ago	Dogs were domesticated in Iraq
8700 B.C.	Sheeps were domesticated in Iraq
7700 B.C.	Goats were domesticated in Iraq
7500 B.C.	Invention of polished stone implements, cultivation of crops like wheat and barley in middle east.
6000 B.C.	Cattle and pigs were domesticated in middle east
4400 B.C.	Maize was cultivated in Mexico
3500 B.C.	Potato was grown in south America
3000 B.C.	Bronze was used to make tools in middle east
2900 B.C.	Plough was used in middle east
2700 B.C.	Silk moth was domesticated in China
2300 B.C.	Poultry, buffalo and elephant were domesticated in Indus valley.
2200 B.C.	Rice cultivation started in India
1800 B.C.	Ragi cultivation started in Karnataka (India)
1780 B.C.	Kulthi (<i>Dolichus biflorus</i>) was cultivated in Karnataka
1725 B.C.	Jowar (Sorghum) cultivation started in Rajasthan
1700 B.C.	Horse husbandry started in Central Asia
1500 B.C.	Pulses (Green and Black gram) were cultivated in Madhya Pradesh Cultivation of Barley and Sugarcane started in India. Irrigation from wells started.
1400 B.C.	Iron was in use in Middle east
1000–1600 B.C.	Iron ploughs were in use
15 century A.D.	Cultivation of sweet orange, sour orange, wild brinjal, pomegranate was there
16 century A.D.	Introduction of crops like potato, sweet potato, cassava, tomato, chillies, pumpkin, papaya, pineapple, guava, custard apple, groundnut, cashew nut, tobacco, American cotton, rubber was done into India by Portuguese.

A. Land Resources

For crop production the basic input is land. Planet earth is of 15.2 billion ha avails 3.8 ha per person (Canada 50, Australia 50, S. America 10, USSR 10, USA 4, France 1.2, India 0.8 and Japan 0.4). The continuing population increase will result in available cultivable land per capita world-wide from 0.3 ha in 1988 to 0.17 ha in 2050, with only 0.11 per capita in developing countries. The nutrient losses due to soil erosion of one of good top soil in kg are 4 N, 1 P₂O₅, 20 K₂O and 2 CaO, besides organic matter. Only 10 to 11 per cent of cultivated area is reasonably free from all constraints for crop production. The FAO's analysis of growth patterns in crop output in 93 developing countries shows that 63 per cent of the growth in production must come from higher yields and 15 per cent from higher cropping intensity. Only 22 per cent is expected from land reserve.

Of the total 6444 m. ha of rainfed agricultural potential, only 30 per cent is suitable, 10 per cent marginal and 60 per cent unsuitable in different countries. The semiarid tropics (SAT) comprise of all or part of 50 countries in five continents of the world (Central America, SW Asia, Africa, South America and South East Asia) is the home of 700 million people who are under perpetual threat drought and occasional famine. About 65 per cent of the arable land carries untapped potential cereals, pulses

and oilseeds, the biggest gains to the food ladder of the globe would be from improvement of agriculture. India has the largest SAT area (10%) of any of the developing countries.

Environmental degradation is increasing at a pace that is impairing the productivity of land and undermining the welfare of rural people. Global assessment of soil degradation (GLASoD) defines soil degradation as a process that describes human induced phenomena, which lower the current and/or future capacity of the soil to support human life. The causes for degradation are:

- Removal of vegetative cover through agricultural clearing,
- Decrease in soil cover through removal of vegetation for fuel wood, fencing, etc.
- Overgrazing by livestock leading to decrease in vegetative cover and trampling of the soil
- Agricultural activities like cultivation in steep slopes, farming without anti-erosion measures in arid areas, improper irrigation and use of heavy machinery, and
- Soil contamination with pollutants such as waste discharges and over use of agrochemicals.

Modern farm technologies are more productive on good soils than on poor soils. Technology may sustain yields by making the effects of soil degradation temporarily. Yield increase through technology might have been greater if the soil has not been degraded.

B. Water Resources

Of the total volume of 1400 million cubic km (M cu km) water, 97 per cent is sea water. Of the balance 3 per cent, 22 per cent is ground water and 77 per cent locked up glaciers and polar ice caps, leaving less than one per cent of fresh water to take part in hydrological cycle. Global water use doubled between 1940 and 1980 and is expected to double again by 2010 A.D. with two-thirds of the projected water use going to agriculture. Today one-third of the world's crops come from its 280 M ha of irrigated land. After world war II, foreign aid helped carry irrigation even to arid corners of the world. As on 1990, about 270 M ha of area, contributing to 17 per cent of the total cropped area, was under irrigation in the world. Today, irrigated farming systems of the past are under serious threat of extinct due to salinity, poor drainage and weak management. Irrigated land damaged through salinisation from the top five countries, as percentage of total area irrigated by 1985 are: India 36, China 17, USSR 18, USA 44 and Pakistan 25. Irrigated area per capita for India (1989) is 0.057 ha as against 0.049 ha for the world. In rainfed agriculture, the cropping intensity of world is 0.74. Under irrigation, the current intensity of 1.21 may increase to 1.29. To maintain a diet of 2000 Cal day⁻¹ requires 300 m³ of water per day and 420 for a diet of 3500 Cal. Bringing one ha of new land under cultivation will produce 0.9 tonnes of cereal grain, one year supply of food for about five people at FAO minimum nutritional standard of 1600 Cal day⁻¹. If the land is irrigated, the total production increases four folds to 3.5 tonnes ha⁻¹. At this level, if future irrigated area of the world reaches 1.0 billion ha, enough food for 10 billion people at twice the FAO level.

In spite of the fact that irrigation can provide food for ever increasing population, experience in the recent decades in expansion of irrigated area ran into several problems leading to land degradation. Year to year changes in world irrigated area reflect the sum of the addition of the new capacity and loss of established capacity due to aquifer depletion, lowered water tables, abandonment of waterlogged area and salted land, reservoir silting and diversion of irrigation water to non-agricultural use. The future food production from irrigated areas depends more on the gains in water use efficiency than on additional new supplies.

C. Food Scenario

Cereals area grown throughout the world to provide food for the human consumption and feed and

fodder for livestock. They are grown in 73.5 per cent of the world's arable land and contribute 74.5 per cent of the global calorie production. Demand for food is growing with ever increasing world population. Compared with present production of about 1.9 billion tones, the demand for cereals is likely to go up to 2.4 billions by the year 2000 A.D. While demand for wheat and rice may be increased in the next two decades by 31 and 53 per cent, respectively, the demand for coarse grains may double. Developed nations may meet their cereal demand by increasing production at 1.8 per cent per annum. However, most of the developing countries with growth rate of 2.5 per cent per annum in cereals production fall short of this requirement, which is increasing at the rate of 3.3 per cent per annum due to high population growth rate. The FAO estimates clearly indicate the increasing shortage of cereals in 90 developing countries.

Increase in food all over world during the decades of 1972–92 was remarkable. Productivity and production in the technologically advanced agriculture of the developed countries rose to heights that would have been unbelievable half a century ago, mainly due to introduction of high yielding varieties (HYVs) responsive to inputs of fertilities and irrigation water, besides increase in area under cultivations.

Developing countries presented a different picture. Only about a third of their population (excluding China) lived in countries with satisfactory performance in agricultural production. Elsewhere, output was raising more slowly than population. Africa in 1970s became the striking example of production inadequacy. There were many constraints limiting agricultural productivity, particularly that of small farmers in developing countries.

- Land remained so unequally distributed that farms were too small and steadily became smaller as rural population grew.
- Input supplies and services were insufficient and access to them most unequal,
- Resources devoted to research, training and extension were very limited, and
- Priority was given to industry, not agriculture, and food prices were shaded in the interest of urban consumers rather than of rural producers.

The FAO aimed at doubling the agricultural production in the developing countries between 1980 and 2000. The hopeful outcome depends on achieving an ambitions transformation involving wide-spread modernization in technology, based primarily on massive increase in inputs to agriculture. Developed countries do not come directly into the exploration of the future as they continue to raise their farming. The strategy is:

- Heavy investment in agricultural sector to make full use of the improved technology.
- Increasing crop production sources through arable land growth, cropping intensity and crop productivity.
- Expanding and conserving the land, based through land reforms directed at bringing underused land in to more intensive exploration and soil and water conservation to the dangers of land degradation, and
- Intensifying land use in crop production through irrigation, fertilizers, improved cultivates, plant protection and mechanization.

D. Towards 21st Century

According to World Bank projections, the world population could reach a stationary level of just under 10 billion by around the end of 21 century, compared with 6.2 billions during 2000 A.D. Significance of these projections is faster growth in population than in food requirements. Almost all the population

increase (95%) takes place in the present day developing countries, which have low per capita consumption levels. Simple lesson from projection is that world demand could increase by 50 per cent in the next 20 years, would more than double again in the first half of the next century.

Doubling the world's food and agricultural production between 2000 and 2055 A.D. sounds daunting. To meet satisfactorily the food and agricultural demands of about 10 billion people, taking in to account the non-agricultural use of the land and seas, will require at least indicative global source use planning. It is clear that sustained rapid increase in crop and livestock yields must be the main stay of future output growth. A continuation to the middle of the 21st century of the expansion of arable land for the next 20 years would mean that virtually all of the potential arable land would be cultivated. The backup of agricultural research and extension must be more oriented to the problem of developing country agriculture.

The 21st century must inherit a food and agricultural system in the developing countries which is much more productive and equitable than it is now. By of continuously absorbing further innovations. The foundations for enormous increase in output needs in the first part of the 21st century must, therefore, be laid in what is left of this century. Attaining the targets proposed for this later period is a pre-requisite for improving the lives not only of those now living but also of further generations.

1.3.2.1 Development of scientific agriculture in world

1. Francis Bacon (1561–1624 A.D.) : Found the water as nutrient of plants
2. G.R. Glanber (1604–1668 A.D.) : Salt peter (KNO_3) as nutrient and not water
3. Jethrotull (1674–1741 A.D.) : Fine soil particle as plant nutrient
4. Priestly (1730–1799 A.D.) : Discovered the oxygen
5. Francis Home (1775 A.D.) : Water, air, salts, fire and oil from the plant nutrients
6. Charles and Francis (1780 A.D.) : Isolated and characterized Indole -3- Acetic Acid (IAA)
7. Thomas Jefferson (1793 A.D.) : Developed the mould board plough.
8. Theodore-de-Saussure : Found that plants absorb CO_2 from air and release O_2 ; soil supply N_2 and ash to plants
9. Justus van Liebig (1804–1873 A.D.) : A German chemist developed the concept called "Liebig's law of minimum". It states as follows.

"A deficiency or absence of the necessary constituent, all others being present, renders the soil barren for crops for which that nutrient is needed"—It is referred as "Barrel concept". If the barrel has stones of different heights, the lowest one establishes the capacity of the Barrel. Nitrogen has the lowest share, establishes the maximum capacity of the barrel. Accordingly, the growth factor in lowest supply (whether climatic, edaphic, genetic or biotic) sets the capacity for yield. Similarly a soil deficient in nitrogen (N) can't be made to produce well by adding more calcium (Ca) or potassium (K) where they are already abundant.

10. In 1875, Michigan State University was established to provide agriculture education on college level.
11. Gregor Johann Mendel (1866) discovered the laws of heredity.
12. Charles Darwin (1876) published the results of experiments on cross and self-fertilization in plants.
13. Thomas Malthus (1898) Proposed "Malthusian Theory" that the human race would run or later run out of food for everyone in spite of the rapid advances being made in agriculture at that time,

because of limited land and yield potential of crops.

14. Neo Malthusians have proposed birth control as answer to the problem.
15. F.T. Blackman's (1905) Theory of "Optima and Limiting Factors" states that, "when a process is conditioned as to its rapidity by a number of separate factors, the rate of the process is limited by the pace of the slowest factor."
16. E.A. Mitscherlich (1909) proposed a theory of "Law of diminishing returns" states that, 'The increase in any crop produce by a unit increment of a deficient factor is proportional to the decrement of that factor from the maximum and the response is curvilinear instead of linear'. Mitscherlich equation is $dy/dx = C (A-Y)$ where,
 - d – increment or change
 - dy – amount of increase in yield
 - dx – amount of increment of the growth factor x .
 - A – Maximum possible yield
 - Y – Yield obtained for the given quantity of factor 'x' and
 - C – Proportionality constant that depends on the nature of the growth factor.
17. Wilcox (1929) proposed "Inverse Yield–Nitrogen law" states that, the growth and yielding ability of any crop plant is inversely proportional to the mean nitrogen content in the dry matter.
18. Macy (1936): Proposed a concept of "Critical Percentages of Plant Nutrients". He suggested a relationship between the sufficiency of nutrients and plant response in terms of yield and nutrient concentration of plant tissues. Macy proposed critical percentages for each nutrient in each kind of plant.

In the tissues minimum percentage range, an added increment of a nutrient increases the yield but not the nutrient percentage. In the poverty adjustment range, an added increment of a nutrient increases the nutrient percentage but not the yield. In the luxury consumption range, added increment of nutrient have little effect of yield. But increase the nutrient composition percentage.

The point between poverty adjustment and luxury consumption was the "Critical percentage". Macy suggested that Liebig's law holds good in the tissue minimum percentage range because there is not enough of a nutrient to allow much plant growth. Liebig's law holds good again in the luxury consumption range. Because there is a large supply of nutrient, some other nutrient becomes limiting and stops growth. Mitscherlich's law of diminishing returns holds during the poverty adjustment range because the response curve is linear representing the diminishing yield to added increments.

19. Zimmerman and Hitchcock (1942) reported that 2,4-D could act as growth promoter at extremely low concentration. Now 2,4-D is used to overcome the problem of seediness in Poovan banana.
20. In 1945, herbicide 2,4,5-T was developed.
21. In 1954, Gibberlic acid structure was identified by Japanese.
22. In 1950's Bennet and Clark identified ABA (Abscessic acid), which inhibits plant growth and controls shedding of plant parts.

Table 1.2 History of Agriculture in India

1947	CTRI at Rajmundry (Tobacco)/Food Policy Committee
1949	CPRI at Patna
1956	CPRI shifted to Simla
1950	IARI established at New Delhi
1951	Fertilizer factory at Bihar
1952	IISR at Lucknow (sugarcane)
1955	NDRI at Karnal (Dairy)
1956	PIRRCOM Project for intensification of regional research on cotton, oil seeds and millets. (Central Cotton Research Institute–Regional Centre)
1959	CAZRI at Jodhpur (Rajasthan) (Arid zone)
1960	IADP (Intensive Agriculture District Programme)
1960	IRRI, Philippines
1962	IGFRI at Jhansi, Uttar Pradesh; G.B. Pant Nagar Agricultural University and Technology at Pant Nagar
1963	CTCRI, Trivandrum (Tuber crops)/National Seed Corporation (NSC)
1965	IAAP (Intensive Agriculture Area Programme)
1966	HYVP at Bangalore (Horticulture)
1969	CSSRI (Central Soil Salinity Research Institute) at Karnal (Haryana)
1970	CPCRI at Kasargod (Kerala) (Plantation crops)/Drought Prone
1971	TNAU (Tamil Nadu Agricultural University) at Coimbatore) and All India Co-ordinated Project for Dry land Agriculture
1972	ICRISAT at Patancheru, Hyderabad/National Commission on Agriculture
1974	Command Area Development
1976	IRD (Integrated Rural Development Programme)
1977	T&V (Training and Visit System)
1979	NARP (National Agricultural Research Project)
1980	Wealth Tax on Agriculture was abolished
1982	NABARD (National Bank for Agriculture and Rural Development)
1985	NAEP (National Agricultural Extension Project)
1995	NRCB at Tiruchirappalli, Tamil Nadu (Banana)
1998	NATP (National Agricultural Technology Project)
2006	NAIP (National Agricultural Innovation Project)

The details on history of agriculture in India are in the subsequent Chapter 2.

1.4 AGRICULTURE IN NATIONAL ECONOMY

Agriculture forms the backbone of the Indian economy and despite concerted industrialization in the last 40 years, agriculture still occupies a place of pride. Agriculture is contributing nearly 30 per cent of the national income, providing employment to about 70 per cent of the working population and accounting for a sizable share of the country's foreign exchange earnings. It provides the food grains to feed the large population of 85 crores. It is also the supplier of raw material to many industries. Thus,

the very economic structure of the country rests upon agriculture. The present role of agriculture in the Indian economy is discussed below.

A. Contribution to National Income

The data supplied by the National Income Committee and the Central Statistical Organization clearly shows that agriculture contributed about 56 per cent of the national income in 1950–51 but contributed only 22 per cent of the national income in 2006–07. The perusal of data in Table 1.3 reveals that the share of agriculture in the national income was reckoned at about 56 per cent during 1950–51 and remained above 50 per cent during the following twenty years. However, the contribution of agriculture has declined in the last fifteen years due to rapid increase in the production of industrial goods and services.

Table 1.3. Contribution of Agriculture to National Income

<i>Year</i>	<i>Percentage contribution of agriculture–GDP</i>
1950-51	56.1
1960-61	51.2
1970-71	50.6
1980-81	42.0
1984-85	36.9
1989-90	30.0
1999-2000	24.0
2000-01	22.3
2001-02	22.2
2002-03	20.2
2003-04	20.7
2004-05	NA
2005-06	NA
2006-07	22.0

A comparison between shares of agriculture in national income in India with that in other countries further emphasizes dominance of agriculture in the Indian economy. In 1983, agriculture contributed only two, three, four and five per cent of the national income in U.K., U.S.A., Canada and Australia respectively. It means the more developed a country, the smaller is the share of agriculture in the national income or output. Hence, the Indian economy cannot be considered as advanced.

B. Contribution to Employment

Agriculture, directly or indirectly, has continued to be the main source of livelihood for the majority of the population in India. The decennial censuses indicate that 70 per cent of the population is supported by agriculture. These censuses show that an overwhelming majority of workers have been engaged in cultivation. Dependence of working population on other fields of agriculture like livestock, fisheries, forest etc., is less. The distribution of agricultural labourer force and population is given in Table 1.4.

On the basis of above figures, it can be concluded that:

- The rate and pattern of investment in other economic sectors have not been such as to draw away surplus rural labourer and relieve the pressure of population on land.

Table 1.4. Distribution of Agricultural Labourer Force as % of Total Work Force

<i>Year</i>	<i>Cultivators labourers</i>	<i>Agricultural</i>	<i>Livestock, fishery, forestry, plantation etc.,</i>	<i>Total agricultural work force</i>
1951	50.0	19.7	2.4	72.1
1961	52.8	16.7	2.3	71.8
1971	43.4	26.3	2.4	72.1
1981	43.9	24.8	2.9	71.6
1988-89	41.6	24.9	3.5	70.0
1991				
2001				
2006				

Source: www.agricoop.nic.in

- Since the growth of agricultural sector was very slow it failed to create enough opportunities for additional employment. It has resulted in widespread under-employment and arising backlog of unemployed.

The proportion of working population engaged in agriculture in other countries is very small. It is only two and three per cent in the U.K. and the U.S.A., 6 per cent in Australia and 7 per cent in France. In backward and underdeveloped countries the proportion of working population engaged in agriculture is quite high. For instance, it is 42 per cent in Egypt, 52 per cent in Indonesia and 72 per cent in China.

C. Contribution of Manpower to industry

The agricultural labourer of rural sector has been the supplier of manpower to industry. The findings of the Commission on Labourer are indicative that the Indian factory operatives were nearly all migrants from the rural areas. This drift to urban areas continues. This is due to lack of opportunities for employment and income in rural areas on the one hand and lure of employment, higher income and urban facilities on the other.

D. Contribution to Foreign Exchange Resources

Agricultural products—primary produce and manufactured through agricultural raw material occupy an important place in the country's export. According to an estimate, agricultural commodities like raw cotton and jute, unmanufactured tobacco, oilseeds, spices, tea and coffee accounted for about 49 per cent of the total value of exports in 1988–89. This makes a sizable contribution to the foreign exchange resources of the country.

E. Interdependence between Agriculture and Industry

There is a close interdependence between agriculture and industry. This is to the supply of raw materials and inputs from agriculture to industry and vice-versa; secondly, the supply of wage goods to the industrial sector; thirdly, the supply of basic consumption goods to the agricultural population; and finally, the supply of materials for the building up of economic and social overheads in the agricultural sector. The interdependence between agriculture and industry is becoming stronger as the economy is developing. The application of science and technology in agriculture induces innovations in respect of

industrial products, which are used for agricultural production. Agricultural inputs like fertilizers, pesticides, diesel oil, electric motor, diesel engines, pump sets, agricultural tools and implements, tractors, power tillers etc., are supplied by the industry and oil, sugar, jute and cotton textiles and tobacco industries rely heavily on the agricultural sector. Even the processing industries, which are utilizing agricultural raw material, and developing fruit canning, milk products, meat products etc.

F. Contribution to Capital Formation

The pace of development is largely determined by the rate at which production assets increase. Before independence, the capital formation in Indian agriculture was of a low order. During this period, agriculture suffered from constant low yield technology, inequitable land tenure system and exploitation of the rural masses. The capital formation includes land development, construction of houses etc. Since independence, much more investment both public and private has been made in agriculture. The creation of physical assets has generally taken the form of land development, construction of irrigation facilities, roads and communication, farm buildings, agricultural machinery and equipment, warehouses, cold storages, market yard etc. This capital formation is helping not only development of agriculture but also the entire economy.

G. Contribution to Purchasing Power of People

Agriculture provides purchasing power not only to those directly engaged in it but to others also who are in the industries and services. When farmers earn more they also spend more. In the process, they create new markets and new opportunities for hundreds of blacksmiths, carpenters, masons, weavers, potters, leather workers, utensil-makers, tailors, cotton ginners, oil pressers, transporters and countless others.

Thus, there are many industries, the prosperity and employment of which are dependent upon the purchasing power of the agricultural population. Hence, it is concluded that besides purchasing food for non-agricultural workers and raw materials for consumer industries, it has created demands for a great many new industries, which, in turn, have provided high and well paid employment. This existing role of agriculture in the Indian economy points out the necessity for the development of Indian agriculture to the fullest extent possible as the prosperity of agriculture largely stands for the prosperity of the economy. The significance of agriculture lies in the fact that the development in agriculture is an essential condition for the development of the national economy.

1.5 FOOD PROBLEM IN INDIA

A. Food Production Trends

The trends in food grains output in recent years have exhibited some significant qualitative changes. On the other hand, there was significant effect of drought on the food grains production during the year 1987–88 and 2002–2003.

Rice production fluctuated around 60 million tones for five years and then followed the rising trend from 1988–89. This was possible due to government's efforts to increase the productivity of rice in the country in general and in the eastern parts of the country in particular. What production had been staggering around 45 million tones for five years before a quantum jump in 1988–89. But there was a fall in wheat production during 1989–90, which was attributed to shift of wheat area to oilseeds for getting better prices of the produce. The production of pulses has also been stagnant around 12–13 million tones except for a fall in the drought year *i.e.*, 1987–88. The trends of coarse grains and kharif food grains are in the same line as of rice while rabi food grains followed the trend of wheat. Since the

contribution of rice in the total food grains production was the greatest, therefore, total food grains also followed the trend of rice production over the years.

Table 1.5. Food Grain Production in India

<i>Year</i>	<i>Food grain production (m.t.)</i>
1950-51	50.82
1960-61	82.02
1970-71	108.42
1980-81	129.59
1983-84	152.40
1984-84	145.50
1985-86	150.40
1986-87	143.40
1987-88	140.40
1988-89	169.90
1989-90	171.10
1990-91	176.39
1996-97	199.30
1997-98	192.43
1998-99	195.25
2000-01	196.80
2001-02	212.00
2002-03	173.70
2003-04	213.50
2004-05	213.50
2005-06	204.60
2006-07	209.30

B. Food Problem

India's food problem dates back prior to independence. In the beginning, India's food problem was one of scarcity, shortage of rice after the separation of Myanmar (Burma) from India in 1937 and shortage of wheat, also after the partition of the country in 1947. Initially, the major concern of the Government was to increase the domestic supplies either through increased production or through imports or through both. In the second half of the 1950s and during the 1960s the major concern of the Government shifted to control of food grains prices. The Government of India entered into an agreement in 1956 with the USA known as PL 480 agreement for the import of rice and wheat. The Government found the PL 480 food imports a good tool to stabilize food prices in the country. In fact, PL 480 imports were the basis of our agricultural and industrial development.

The Government set up the Food grains Policy Committee in 1966 to review the food problem afresh. The committee found India's dependence on food imports was not likely to be easy in future. It took serious note of the fact that the food aid was used openly to influence the internal economic policies and foreign affairs policies of the Government. Between 1967-68 and 1989-90, Punjab, Haryana and Uttar Pradesh had recorded annual growth rates of 5.4, 4.0 and 3.4 per cent, respectively in food grains production. These states are the backbone of our public distribution system. These states have

insulated the country from a food grains crisis. In the 1970s and particularly after 1974, there has been a growing surplus of stocks from the original target of 5.0 million tones; the Government had succeeded in accumulating over 30 million tones of buffer stock of food grains during the 1980s. Actually, it was the huge reserves of food grains which helped the Government to tide over successfully the three years of poor food grains production, culminating in the widespread drought of 1987–88.

The food problem is not any more one of shortage or of high prices but how to enable the lower income groups to purchase the available food grains and how to make use of the huge food stocks to help accelerate the process of economic growth. The food for work programme has been designed since 1977–78 to provide work for the rural poor, the unemployed and the famine stricken people and at the same time create durable community assets. The Government is also implementing a scheme to provide food grains to the weaker sections, especially in the tribal areas at a price well below the already subsidized price in the public distribution system. There has been a general agreement that the food problem in India is mainly due to the increasing population (consequently increasing food demand), inadequate supply of food grains and some aspects of the Government's policy on food.

C. Measures to Solve the Food Problem

India's food problem is older than our independence but it is a pity that no permanent solution has been found all these years. The Government of India has taken various steps to solve the food problem, which are discussed ahead.

D. Measures to Increase Production

Technological changes : Among the measures to increase the production of food grains, the least controversial are technological changes. Intensive cultivation through use of improved varieties and the liberal use of irrigation and fertilizers is being vigorously extended in the country ushering in the green revolution. The latest step is to bring about a break through in rainfed and dry land agriculture.

Organizational approach : The second approach to agricultural development is the organizational approach *i.e.*, by adequate and efficient organization, which includes not only the governmental administrative system but the entire framework of official and semi-official institutions and agencies. It is opined that the efforts to increase agricultural production through technological changes have not been very successful mainly because of an inadequate and ineffective organization. Institutional changes the other way to increase agricultural production is through bringing institutional changes *i.e.*, through land reforms. The present agrarian structure is such that there are no incentives for increased production. With tiny holdings, which are scattered all over the village, with a system of landholdings in which the tenant has no security of tenure, it is not wise to expect the tiller to put his best efforts to increase food production. The Government has been pursuing many land reform measures such as consolidation of holdings, ceiling on holdings, regulation of tenures and the formation of cooperative farms. Since there are many loopholes in the regulation of land reforms, there is urgent need to plug these loopholes through effective legislations on the part of the Government.

Distributional changes : In the last few years, the Government has expanded the public distribution system (PDS) considerably. From over two million tones in 1956, the public distribution system has handled over 19 million tones in 1987–88. In 1991, steps were taken to revamp the PDS and its reach extended to 1700 blocks in far-flung and disadvantaged areas like economically backward, drought prone, desert and hilly areas. Allocation of rice, wheat, etc., under the PDS should be increased for the lean period. There is need of the hour to strengthen the public distribution system in the country.

Stabilization of food grains prices : The main objective of the food policy in recent years has been to hold the food grains prices in check. The Government has been adopting such short-term measures

as the maintenance of stocks at high level, extension of internal procurement, stepping up of government purchase of food grains for release through fair price shops, measures to curb hoarding and profiteering and fixation of maximum control prices. These measures did have some influence in keeping prices in check but past experience shows that price stability has not been fully achieved. The buffer stock operation by the Government is the key to the problem of stabilization not only of food prices but also of general price level in the country. The Government decided to build up a buffer stock of 5 m.t. of food grains by 1973–74 but the actual stock with the Government from 1979 onwards has been over 20 m.t. which is a good sign. It is opined that if it is managed with wisdom and flexibility, it would go a long way to protect both the farmer and the consumer against severe fluctuations in prices. The existence of large food stocks creates a feeling of complacency that the food shortage is a thing of the past. There is every possibility of the output becoming larger with the expansion of irrigation facilities, fertilizers availability, rural electrification, etc. But it should be very clearly understood that the highly fluctuating monsoon and the consequent ups and downs in food output can always spell danger. Naturally, efforts, should continue to keep the population in check to take full advantage of increase in agricultural production.

1.6 AN INTRODUCTION TO AGRONOMY

The word agronomy has been derived from the two Greek words, *agros* and *nomos* having the meaning of **field** and **to manage**, respectively. Literally, agronomy means the “art of managing field”. Technically, it means the “science and economics of crop production by management of farm land”.

Definition : Agronomy is the art and underlying science in production and improvement of field crops with the efficient use of soil fertility, water, labourer and other factors related to crop production. Agronomy is the field of study and practice of ways and means of production of food, feed and fibre crops. Agronomy is defined as “a branch of agricultural science which deals with principles and practices of field crop production and management of soil for higher productivity.

Importance : Among all the branches of agriculture, agronomy occupies a pivotal position and is regarded as the mother branch or primary branch. Like agriculture, agronomy is an integrated and applied aspect of different disciplines of pure sciences. Agronomy has three clear branches namely, (i) Crop Science, (ii) Soil Science, and (iii) Environmental Science that deals only with applied aspects. (*i.e.*,) Soil-Crop-Environmental relationship. Agronomy is a synthesis of several disciplines like crop science, which includes plant breeding, crop physiology and biochemistry etc., and soil science, which includes soil fertilizers, manures etc., and environmental science which includes meteorology and crop ecology.

Basic Principles

- Planning, programming and executing measures for maximum utilization of land, labourer, capital and other factors of production.
- Choice of crop varieties adaptable to the particular agro-climate, land situation, soil fertility, season and method of cultivation and befitting to the cropping system;
- Proper field management by tillage, preparing field channels and bunds for irrigation and drainage, checking soil erosion, leveling and adopting other suitable land improvement practices;
- Adoption of multiple cropping and also mixed or intercropping to ensure harvest even under adverse environmental conditions;
- Timely application of proper and balanced nutrients to the crop and improvement of soil fertility and productivity. Correction of ill-effects of soil reactions and conditions and increasing soil

organic matter through the application of green manure, farm yard manure, organic wastes, bio fertilizers and profitable recycling of organic wastes;

- Choice of quality seed or seed material and maintenance of requisite plant density per unit area with healthy and uniform seedlings;
- Proper water management with respect to crop, soil and environment through conservation and utilization of soil moisture as well as by utilizing water that is available in excess, and scheduling irrigation at critical stages of crop growth.
- Adoption of adequate, need-based, timely and exacting plant protection measures against weeds, insect-pests, pathogens, as well as climatic hazards and correction of deficiencies and disorders;
- Adoption of suitable and appropriate management practices including intercultural operations to get maximum benefit from inputs dearer and difficult to get, low-monetary and non-monetary inputs;
- Adoption of suitable method and time of harvesting of crop to reduce field loss and to release land for succeeding crop(s) and efficient utilization of residual moisture, plant nutrients and other management practices;
- Adoption of suitable post-harvest technologies.
- Agronomy was recognized as a distinct branch of agricultural science only since about since about 1900. The American Society of Agronomy was organized in 1908.

1.6.1 Agronomist

Agronomist: “Scientist who studies the principles and practices of crop production and soil management for production of food for human beings and feed for his animals”.

Role of Agronomist

- Generally agronomist studies the problems of crop production and develops better ways of producing food, feed and fibre.
- Agronomist aims at obtaining maximum production at minimum cost *e.g.*, developing efficient and economic field preparation method (*i.e.*) energy should be minimized (*i.e.*) what type of crop, in what season, etc.
- Agronomist shoulder the responsibilities of all social, economic, cultural problems in addition to field problems for the effective functioning of the farm in general.
- Agronomist exploits the knowledge developed by basic and allied, applied sciences for higher crop production.
- Agronomist carries out research on scientific cultivation of crops taking into account the effect of factors like soil, climate, crop varieties and adjust production techniques suitably depending on the situation.
- Since, the agronomist co-operates and co-ordinate with all the disciplines of agriculture, it is essential that an agronomist should have training in other disciplines of agriculture also.
- To develop efficient method of cultivation (whether broadcasting, nursery and transplantation or dibbling, etc.) The method may vary according to the germination period and depending upon the crop establishment and what should be the optimum plant population.
- He has to identify various types of nutrients required by crops, *e.g.*, for long duration rice (150-100-50 kg), for pulses N₂, P and K. If the method of cultivation varies the nutrient content also varies. The time and method of applying nutrients must also be taken into account. Method refers to broadcast or to apply close to the root or through leaves (*i.e.*) foliage.

- Agronomist must select a better weed management practice. Either through mechanical or physical (by human work) or chemical (herbicides or weedicides, *e.g.*; 2-4-D or cultural (by having wide space it may increase weed growth by using inter space crops). Weeds are controlled integrated means.
- **Irrigation management:** Whether to irrigate continuously or stop in between and how much water should be irrigated are calculated to find the water requirement.
- Crop planning (*i.e.*) developing crop sequence should be developed by agronomist (*i.e.*) what type of crop, cropping pattern, cropping sequence, etc.
- Agronomists are also developing the method of harvesting, time for harvesting, etc. The harvest should be done in the appropriate time.
- Decision-making in the farm management. What type of crop to be produced, how much crop, including marketing should be planned? Decision should be at appropriate time.

1.7 POTENTIAL PRODUCTIVITY AND CONSTRAINTS IN CROP PRODUCTION

Potential Yield - It is the maximum possible economic yield for a crop from a unit land area, when all the factors affecting the crop growth and yield are available without any constraints (or) this is the maximum possible yield that could be obtained under controlled condition. Here, all the environmental factors are provided to the crop to express the full potential.

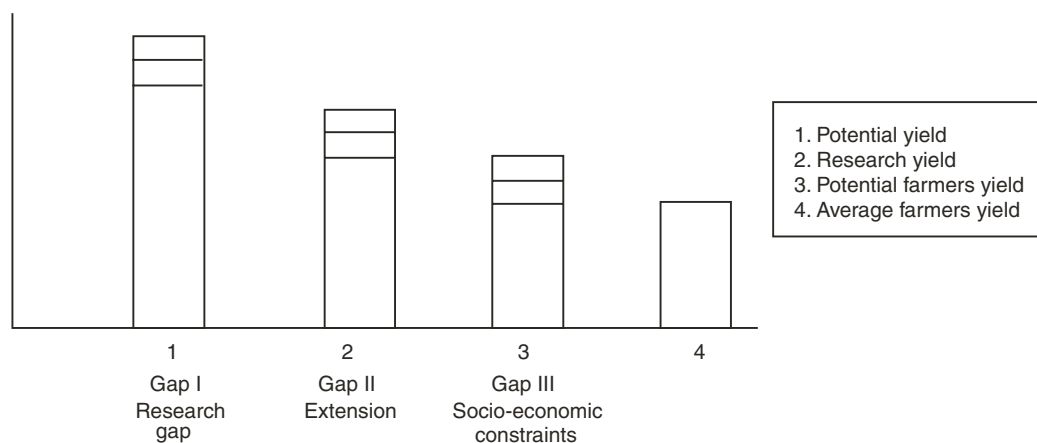

Research yield - The yield obtained in the research station under correct management and supervision by the scientist. Hence, all the technologies are being used by scientists to get maximum yield.

Potential farmers yield - The yield obtained by the progressive farmers under the guidance of scientists using new techniques.

Average farmers yield - Actual yield obtained by the farmer.

Gap I - The latest technologies developed by the scientists are not completely transformed to the extension agency. The extension agency should fill up the gap by advocating the farmers by acquiring themselves with these improved methods of cultivation.

Gap II - Here, there is no input constraints and only environmental constraints exist.

Gap III - Variation in management of field and crop. Only few farmers get higher yield. Gap can be filled up by improving the socio-economic condition of the farmers.

Constraints in Crop Production

I. Ecological

1. Weather
2. Pollution
3. Desertification

II. Production

1. Variety
2. Weed
3. Pests and Diseases
4. Soil health
5. Water (poor quality)
6. Farm machinery
7. Post harvest technology
8. Market facilities

III. Socio-economic

1. Cost and return
2. Credit
3. Risk uncertainty
4. Traditional attitude
5. Knowledge
6. Input availability
7. Institution

Agricultural Heritage of India

GEOLOGY

Ancient History time scale is measured in terms of Before Christ (B.C.) or Before the Common Era (B.C.E.). The geology of Indian sub continent is as follows:

I. Timeline of Mesozoic Era (~251 Ma to ~66 Ma)

- A. Triassic period** (~251 Ma to ~204 Ma) - This period was the earliest period of the Mesozoic era, or the corresponding system of rocks, marked by the first appearance of the dinosaurs.
- B. Jurassic period** (~204 Ma to ~136 Ma) - This period is the period of the Mesozoic era, between the Triassic and the Cretaceous or the corresponding system of rocks, marked by the presence of dinosaurs, and the first appearance of birds.
- C. Cretaceous period** (~136 Ma to ~66 Ma) - This period was marked by the presence of dinosaurs, marine and flying reptiles, ammonites, ferns, and gymnosperms and the appearance of angiosperms, mammals and birds. With the disintegration of the Gondwanaland towards the end of the Cretaceous, the continents acquired their present features, their shapes, the great mountain systems, the courses of the rivers, the great plains, and the climatic zones. The Cenozoic Era that followed the Mesozoic is continued up to the present. It began about 60 million years ago.

II. Timeline of Cenozoic Era (~66 Ma to 10000 years)

The Cenozoic Era is divided into two periods—the Tertiary and the Quaternary. The Tertiary is subdivided into five epochs. The name of each epoch ends with the suffix *one* (Greek, recent) and refers to the progress of life. The Tertiary period has been studied in greater detail than any other period, partly because its flora and fauna bear close similarities to the living forms, but mainly because of economic

		<i>Years</i>	<i>Sub period</i>
Quaternary period	Oligocene Epoch (little recent)	15 million years	Paleocene period or Nummulitic period
	Eocene Epoch (dawn recent)	15 million years	
	Paleocene Epoch (ancient recent)	10 million years	
Tertiary period	Miocene Epoch (less recent)	12 million years	
	Pliocene Epoch (more recent)	10 million years	
	Pleistocene Epoch (most recent)	1 million years	
	Recent Epoch	10,000 years	

reasons, viz., search for petroleum, of which more than 50 per cent of the world production comes from the Tertiary rocks.

2.1 PANGAEA, THE SUPER-CONTINENT

The Earth is a *dynamic* or constantly changing planet. The Earth's crust is broken into many pieces, which are called *plates*. These plates are in constant motion causing earthquakes, mountain building, volcanism, the production of "new" crust and the destruction of "old" crust. There are three kinds of plate boundaries:

1. **Convergent boundary** - Where two plates collide to form mountains or a subduction zone.
2. **Divergent boundary** - Where two plates are moving in opposite directions as in a mid-ocean ridge.
3. **Transform boundary** - Where two plates are sliding past each other as in the San Andreas fault of California.

The Earth's plates are in constant, but very, very slow motion. They move at only 1/2–4 inches (1.3–10 cm) per year!! This does not seem like much, but over millions of years it adds up to great distances of movement. In 1912, *Alfred Wegener* introduced the '*Continental Drift Theory*', which states that the continents have moved, and is still moving today. Scientists believe these plates have been moving for millions of years. In fact, 250 millions years ago the Earth's seven continents were all grouped together into a super continent (one huge landmass) called '**Pangea**'. This huge super continent was surrounded by one gigantic ocean called **Panthalassa**.



The position of the continents of Antarctica was far north of its current position; Australia sipped sideways and far west of its current position and the subcontinent of India was hundreds of miles from Asia. North American continent was located much farther south and east of its position today. North

America was in or near the tropics. Fossils of tropical plants and animals found in cold regions like North Dakota and Greenland.

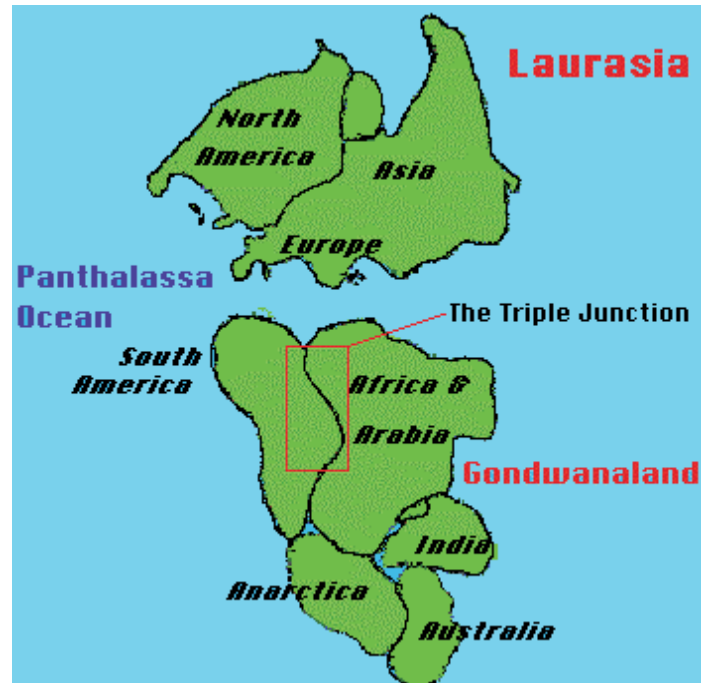

A. 180 million years ago

About 180 million years ago the super continent Pangea began to break up in the Mesozoic Era. Scientists believe that Pangea broke apart for the same reason that the plates are moving today. The movement is caused by the convection currents that roll over in the upper zone of the mantle. This movement in the mantle causes the plates to move slowly across the surface of the Earth. Pangea broke up in four stages. In the first stage during the Triassic period about 200 million years ago, rifting occurred between Laurasia and Gondwanaland. **Laurasia** was made of the present day continents of North America (Greenland), Europe, Angara land comprising Russia, Siberia and China in the north. **Gondwanaland** was made of the present day continents of South America, Africa, India, Australia, and Antarctica. Notice that at this time India was not connected to Asia. The huge ocean of Panthalassa remained but the Atlantic Ocean was going to be born soon with the splitting of North America from the Eurasian Plate.

‘The Triple Junction’ was formed because of a three-way split in the crust allowing massive lava flows in three directions and poured out lava over hundreds of square miles of Africa and South America. The rocks of the triple junction, which today is the west central portion of Africa and the east central portion of South America, are identical matches for age and mineral make up. In other words the rocks in these areas of the two continents were produced at the same time and in the same place. This tells us that South America and Africa were connected at one time. Today these two continents are separated by the Atlantic Ocean, which is over 2000 miles wide.

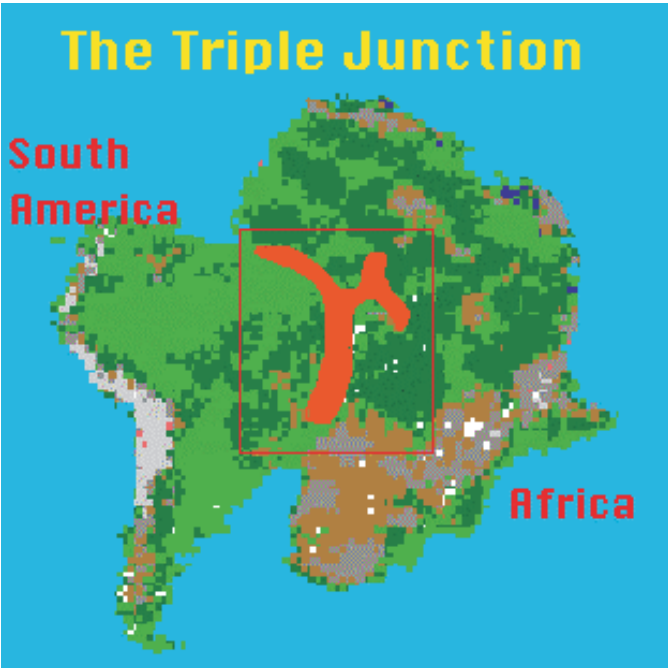

B. 135 million years ago

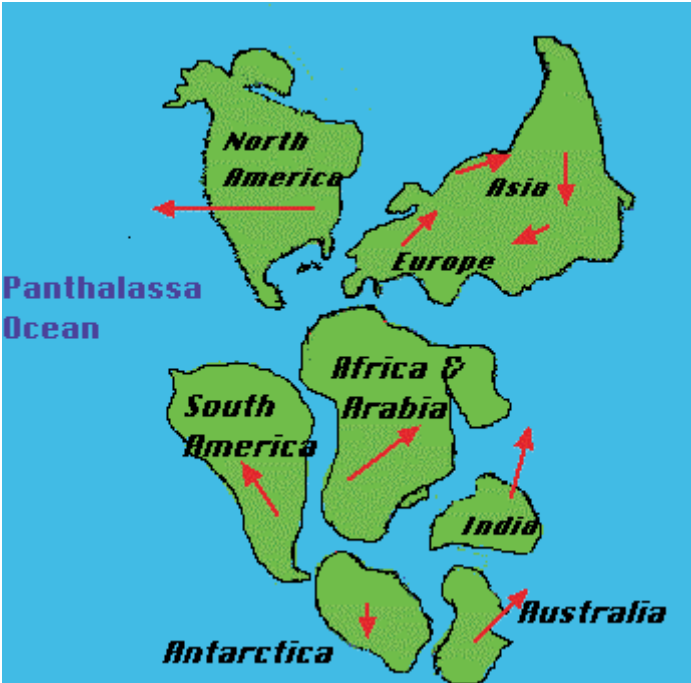

In the Jurassic period about 135 million years ago, Laurasia was still moving, and as it moved it broke up into the continents of North America, Europe and Asia (Eurasian plate). In the second stage, the Gondwana period continents separated from each other during the Jurassic and Cretaceous period. In the late Jurassic, South America separated from Africa. This created another narrow basin between these two continents. The eastern coast of North America separated from the Moroccan bulge of Africa. The breakup of the Gondwanaland opened up the Atlantic and the Indian Ocean. In stage three, the Atlantic extended north, and Eurasia rotated clockwise to close the eastern end of the Tethys Sea, the precursor to the Mediterranean. The Indian Subcontinent moved hundreds of miles in 135 million years at a great speed (4 inches per year). The Indian plate crashed into the Eurasian plate (Asia) with such speed and force that it created the tallest mountain range on Earth, the Himalayas. The Tethys was being squeezed out of existence in the east of the Alpines as India approached Asia.

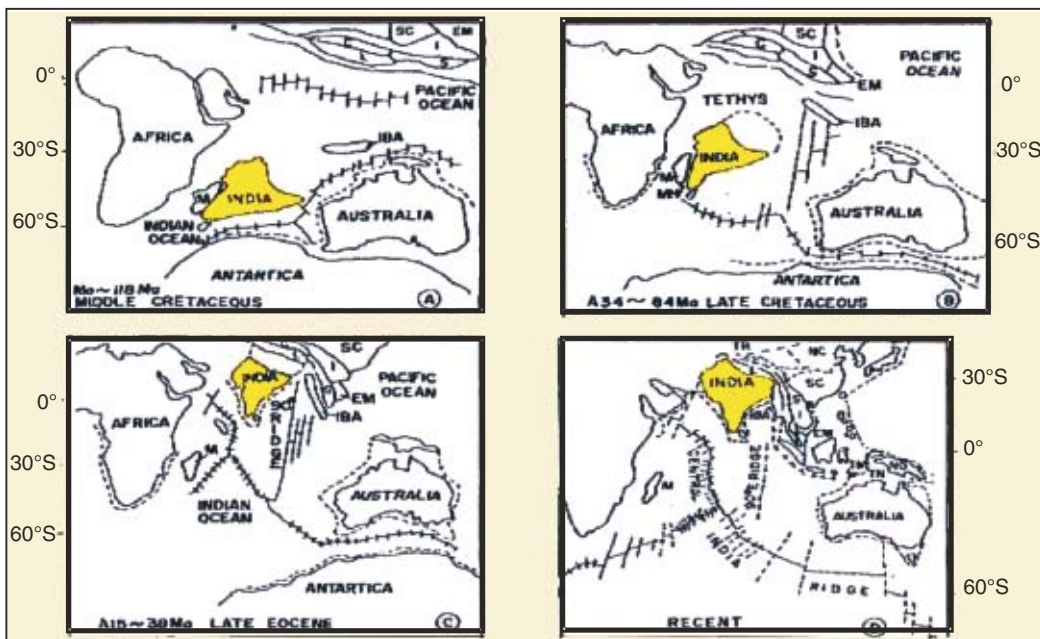

The Himalayas mountain-together with vast amounts of sediment eroded from them were so heavy that the Indian-Australian Plate just south of the range was forced downward, creating a zone of crystal subsidence, or geosynclines into Malagasy (Madagascar) and Australia. Indian coal resource is mainly in the Permian Gondwana sediments. Indian continent being a crystal neighbour of mineral-rich South Africa and West Australia is also rated high for its potential future for mineral prospects. Arabia started to separate from Africa as the Red Sea opened up. The red arrows indicate the direction of the continental movements. As a result of the earth movements, considerable parts of the marginal areas of the Gondwanaland broke off and sank into the oceans. Rifting occurred between Africa and Antarctica, with this rift extending northeastward to India. In the early Cenozoic, Antarctica and Australia separated. The final stage of the dismemberment of Pangea occurred in the early Cenozoic. The North Atlantic rift continued north until North America and Eurasia (Europe) separated. During this stage, Antarctica and Australia separated. The final separation of the continents occurred about 45 Ma. The fragmentation of Pangea took about 150 million years.

2.1.1 Geography of India

The most outstanding fact about the physical geography of India is the natural division of the country with three distinct segments of totally dissimilar character: (i) the Himalayas, the great mountain system to the north, (ii) the Indo-Gangetic alluvial plain of northern India extending from Punjab to Assam, and (iii) the Peninsula of the Deccan to the south of the Vindhya—a solid stable block of the earth’s crust, largely composed of some of the most ancient rocks, which the denudation of ages has carved into a number of mountain ranges, plateaus, valleys and plains. The land area of peninsular India has never been submerged under the sea. The western ghats form the western edge, and the eastern ghats the eastern edge of the plateau, which slopes towards the east whereas the Himalayas and the Indo-Gangetic plain are comparatively young. Marine sediment occurs at the roof of the Everest.

The Cretaceous period began 110 million years ago and lasted for 50 million years. During the middle and the upper Cretaceous, the land areas especially in the Puducherry, Tiruchirappalli sector, are mainly littoral. The fauna of this sector is similar to that of Malagasy (Madagascar) and South Africa and to that of the southern flank of the Assam range. Along the Narmada Valley on the west coast are some marine fossiliferous beds with fossils showing greater affinity with those of the Cretaceous of southern Arabia and Europe than with those of Assam and Tiruchirappalli regions. The dissimilarity indicates that there was still a sort of land barrier that separated the Bay of Bengal from the Arabian Sea. This land barrier has been called Lelluria, which included Peninsular India and Malagasy (Madagascar). The middle and the upper Cretaceous were periods, where volcanic outbursts overwhelmed a vast area, comprising the present Gujarat, Maharashtra and Madhya Pradesh. Several hundred thousand square kilometers were flooded by the outpourings of extremely mobile lava from fissures. The hills formed by the lava are in some places over 1,200 meters high and are known as the Deccan traps. The formation of the Deccan trap continued in the Tertiary Period. Deccan trap covers Sind, Kutch, Bihar, and the coastal areas of Andhra Pradesh.

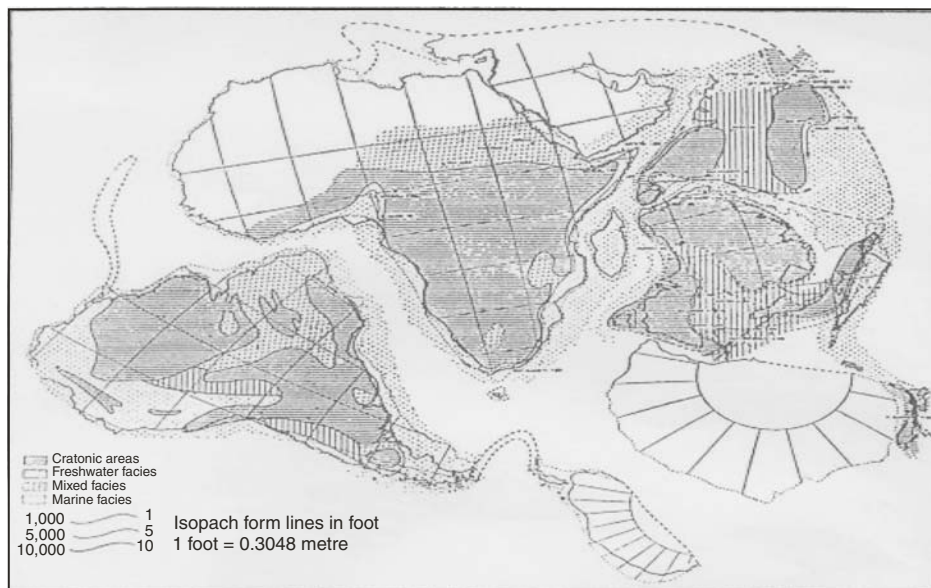

The uplift of the Himalayan system of mountain ranges was due to movements of two solid continental masses on two sides of the Tethys ocean, directed towards one another. The Central Asian

continental mass, Angaraland, slowly moved from the north to the south under pressure from the floor of the Arctic Ocean, and the northern edge of the Indian continental mass, the Gondwanaland, became down warped by the northward compressive force from the Indian Ocean. The Himalayan portion of the Tethys gradually shifted southward and became narrower, assuming its present trend in the early Eocene time. The presence of tongue like projections of the Gondwanaland: one in the Kashmir-Hazara region (the Punjab wedge) and the other in the northeastern extremity of Assam (the Assam wedge) has moulded the pattern of the Himalayan chain. The effects of these two wedges can be clearly seen in any relief map of India. It will be seen that the Himalayan chain occurs as a huge arc between Nanga Parbat in the west and Namcha Barwa in the east. The convexity of the arc points south towards the Indian peninsula. Below the Himalayas is the Siwalik Hills, extending from Jammu in the west to Assam in the east. The Siwalik hills are mainly river deposits of the middle Miocene to the lower Pleistocene Age, folded into arches (anticlines) and troughs (synclines). The fault planes steeply sloping into the hills have given rise to steep scarps facing the plains. Immediately adjacent to and on the north of the Siwalik Hills lies the sub-Himalayan zone or lesser Himalayas, 65 to 80 kilometers wide and of an average altitude of about 3,000 metres. The rocks here are mostly non fossiliferous. Farther north is the central Himalayan zone of high ranges with snow-clad peaks. It consists mainly of metamorphosed sedimentary rocks.

The Indo-Gangetic plains, which lie at the foot of the Himalayas from Hazara to Assam, mark the side of a deep basin of estimated depth of 1,050 to 6,000 metres, which resulted from the compression exerted on the peninsular margin against the advancing crystal waves from the north. The basin has been filled up with the river alluvium derived from the rising Himalayas as well as from the plateau on the south.

Lemuria Civilization - Lemuria was originally the name given to a vast hypothetical sunken continent or a land bridge or landmass stretching from Ceylon to Madagascar all the way to the central Pacific Ocean across the Indian Ocean and Indonesia. Ancient Lemuria-map of India in 30,000 B.C. is presented in following Figure. The lemurs derive their name from that of the Lemurs (or "Ancestors").

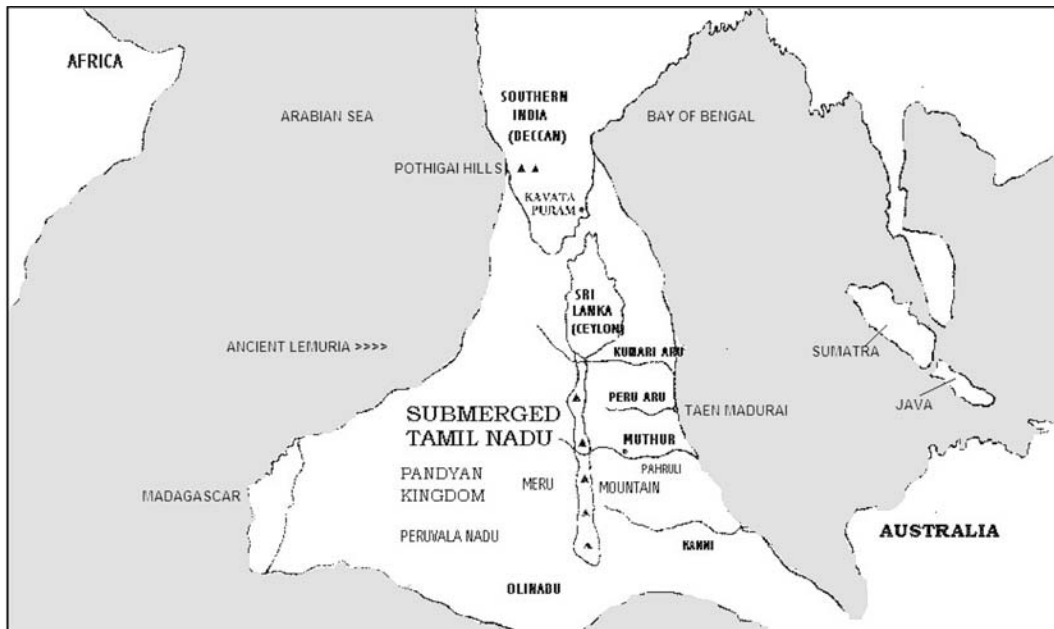

Man descends from the apes. Hence, the name of Lemuria can be interpreted as “Land Ancestral” or “Land of the Ancestors”. The name “Lemuria” was actually invented by an English Zoologist, Phillip L. Schlater, back in the early days of Darwinism, in order to explain the fossilized remains of lemurs similar to those that live in Madagascar only today. The last surviving ‘Lemurs’ exist on Madagascar. This is why the ancient land tying India and Australia together that sank incrementally over time, is referred to as ‘Lemuria’. The Tamil bark writings in Southern India tell of the gigantic Southern part of India, which used to connect to Australia cataclysmically sinking incrementally over a long period of time. This was ancient Lemuria or Kumari Kandam. The first Tamil Sangam was believed to have occurred in the so-called lost continent known as Kumari Kandam. The great flood would have sunk Lemuria or Kumari Kandam before the Ramayana period (10,000 B.C.) since there the existence of an island, Sri Lanka, in the Indian Ocean during the Ramayana period was mentioned.

2.1.2 Agriculture Heritage in India

Agriculture in India is not of recent origin, but has a long history dating back to Neolithic age of 7500–6500 B.C. It changed the life style of early man from nomadic hunter of wild berries and roots to cultivator of land. Agriculture is benefited from the wisdom and teachings of great saints. The wisdom gained and practices adopted have been passed down through generations. The traditional farmers have developed the nature friendly farming systems and practices such as mixed farming, mixed cropping, crop rotation etc. The great epics of ancient India convey the depth of knowledge possessed by the older generations of the farmers of India. The modern society has lost sight of the importance of the traditional knowledge, which had been subjected to a process of refinement through generations of experience. The ecological considerations shown by the traditional farmers in their farming activities are now a days is reflected in the resurgence of organic agriculture.

The available ancient literature includes the four Vedas, nine Brahmanas, Aranyakas, Sutra literature, Susruta Samhita, Charaka Samhita, Upanishads, the epics Ramayana and Mahabharata, eighteen Puranas, Buddhist and Jain literature, and texts such as Krishi-Parashara, Kautilya’s, Artha-sastra, Panini’s Ashtadhyahi, Sangam literature of Tamils, Manusmriti, Varahamihira’s Brhat Samhita, Amarkosha, Kashyapiya-Krishisukti and Surapala’s Vriskshayurveda. This literature was most likely to have been composed between 6000 B.C. and 1000 A.D. The information related to the biodiversity and agriculture (including animal husbandry) is available in these texts.

Rig-Veda is the most ancient literary work of India. It believed that Gods were the foremost among agriculturists. According to ‘Amarakosha’, Aryans were agriculturists. Manu and Kautilya prescribed agriculture, cattle rearing and commerce as essential subjects, which the king must learn. According to Patanjali the economy of the country depended on agriculture and cattle-breeding. Plenty of information is available in ‘Puranas’, which reveals that ancient Indians had intimate knowledge on all agricultural operations. Some of the well known ancient classics of India are namely, Kautilya’s ‘Arthashastra’; Panini’s ‘Astadhyayi’; Patanjali’s ‘Mahabhasya’; Varahamihira’s ‘Brahat Samhita’; Amarsimha’s ‘Amarkosha’ and Encyclopedic works of Manasollasa. These classics testify the knowledge and wisdom of the people of ancient period. Technical book dealing exclusively with agriculture was Sage Parashara’s ‘Krishiparashara’ in 1000 A.D. Other important texts are Agni Purana and Krishi Sukti attributed to Kashyap (500 A.D.). Ancient Tamil and Kannada works contain lot of useful information on agriculture in ancient India. Agriculture in India made tremendous progress in the rearing of sheep and goats, cows and buffaloes, trees and shrubs, spices and condiments, food and non-food crops, fruits and vegetables and developed nature friendly farming practices. These practices had social and religious undertones and became the way of life for the people. Domestic rites and festivals often synchronized with the four main agricultural operations of ploughing, sowing, reaping and harvesting. In the

Rig-Veda, there is reference to hundreds and thousands of cows; to horses yoked to chariots; to race courses where chariot races were held; to camels yoked to the chariots; to sheep and goats offered as sacrificial victims, and to the use of wool for clothing. The famous Cow Sukta (Rv. 6.28) indicates that the cow had already become the very basis of rural economy. In another Sukta, she is defined as the mother of the Vasus, the Rudras and the Adityas, as also the pivot of immortality. The Vedic Aryans appear to have large forests at their disposal for securing timber, and plants and herbs for medicinal purposes appear to have been reared by the physicians of the age, as appears in the *Atharva Veda*. The farmers' vocation was held in high regard, though agriculture solely depended upon the favours of Parjanya, the god of rain. His thunders are described as food-bringing.

The four Vedas mentioned more than 75 plant species, Satapatha Brahmana mentions over 25 species, and Charaka Samhita (C. 300 B.C.) an Ayurvedic (Indian medicine) treatise-mentions more than 320 plants. Susruta (C. 400 B.C.) records over 750 medicinal plant species. The oldest book, Rig-Veda (C. 4000 B.C.) mentions a large number of poisonous and non poisonous aquatic and terrestrial, and domestic and wild creatures and animals. Puranas mention about 500 species of plants. The science of arbori-horticulture had developed well and has been documented in Surapala's Vrikshayurveda. Forests were very important in ancient times. From the age of Vedas, protection of forests was emphasized for ecological balance. Kautilya in his Artha sastra (321–296 B.C.) mentions that superintendent of forests had to collect forest produce through the forest guards. He provides a long list of trees, varieties, of bamboos, creepers, fibrous plants, drugs and poisons, skins of various animals, etc., that come under the purview of his officer. The preservation of wild animals was encouraged and hunting as a sport was regarded as detrimental to proper development of the character and personality of the ruler, according to Manu (Manusmriti, 2nd Century B.C.). Specifically, in the Puranas (300–750 A.D.) the names of Shalihotra on horses, and Palakapya on elephants have been found as experts in animal husbandry. For instance, Garudapurana is a text dealing with treatment of animal disorders while the classical work on the treatment of horses is Aswashastra. One chapter/part in Agnipurana deals with the treatment of livestock and another on treatment of trees.

2.2 DEVELOPMENT OF HUMAN CULTURE

The traditional classification of human social evolution is into pre-history and recorded history. The latter follows the invention of writing and therefore written historical records. The large number of primitive stone tools found in the Soan Valley and South India suggests that the earliest races of human existence in India go back to the period between 400,000 and 200,000 B.C. He learnt to control fire, which helped him to improve his way of living. At the end of this age, the modern human being (*Homo sapiens*) first appeared around 36,000 B.C.

2.2.1 Genetic History of Modern Man

During the early Paleolithic period, at least four species of genus *Homo* (man) inhabited earth:

- (i) ***Homo habilis*** - Parts of skull, hands, legs and feet were discovered in 1960-64 by Louis S.B. Leakey in Tanzania, E. Africa. He was 4 feet tall and used crude tools (bones, limbs from trees, chunks of stone). *Homo habilis* is morphologically too primitive to be an ancestor of *homo erectus*.
- (ii) ***Homo erectus*** - There were two groups viz., (i) Java man remains were discovered dating ca. 1.5 million–500,000 B.C. on the island of Java in 1891. They were 5 feet tall and used group hunting techniques and (ii) Peking man remains were found between 1926–30 who knew the use

of fire (around 500,000 B.C.) to cook food and kept warm; evidence of the first true hand-axe was also found.

- (iii) *Homo ergaster* is morphologically closer to *Homo sapiens* than *H. erectus*.
- (iv) *Homo sapiens* - The modern man was 5'4" tall with a receding chin and heavy eyebrow ridges. He cooked his food, but no houses yet but only semi-nomadic.

Some nuclear DNA sequences (including Y-chromosome data) and mt DNA indicate that modern humans originated and migrated relatively recently from a subset of the African population, putting Africa as the home of modern humanity. A study of human Y-chromosome variation in a worldwide sample of over 1,000 men determined that Africans and non-Africans shared a common ancestor 59,000 years ago and that the non-African branch of humanity left Africa about 44,000 years ago. Other data shows that Africans and non-Africans split about 156,000 years ago. The true migration date is some time between these dates. There seems to be some correlation between these dates and the appearance of modern humans as a species. The last common ancestor of all non-African human Y-chromosomes is estimated to be about 40,000 years (31,000–79,000) ago. Another study of the Y-chromosome of Europeans used 22 markers in 1,007 men across Europe over 80 per cent of the European genes were traced to two migrations of Paleolithic ancestors around 40,000 and 22,000 years ago, respectively. Twenty percent of the European genes were from Neolithic farmers who entered the continent about 10,000 years ago. Early or primitive *Homo sapiens* were adaptable, leading to the adoption of diverse lifestyles based on locally available food resources. Early Europeans hunted reindeer as did the Eskimo. Hunters met migratory herds in autumn on their return from summer tundra pastures to winter forest shelters. This meat could be frozen and used throughout the winter. Modern Eskimos, Australian aborigines and primitive inhabitants of Glacial Europe use a type of spear-thrower, an early technological innovation. Early Europeans had to contend with lions, bears, bison, mammoths, woolly rhinoceros and wild ox. Wood for cave fires was collected from conifer forests. On the southern steppes there was less fuel, so bone served as fuel. *Homo erectus* remains in Sunderland (Java, Sumatra and Borneo), of between 600,000 and 900,000 years old, represent the earliest evidence of our pre-human ancestors in this region. The Australoid colonists of this area are represented today by the Aborigines of Australia, the Highlanders of New Guinea, the Negritos of Malaya and the Philippines.

2.2.2 Development of Human Culture

1. Stone age - The Pre-history Stone age is broken down into three periods, according to the material used for making tools:

- (i) The **Paleolithic Period or Old/Ancient stone age** (2.5 million-12,000 B.C.) - The age in human culture was characterized by the use of rough or chipped stone tools. Man was essentially a food gatherer and depended on nature for food. He learnt to control fire, which helped him to improve his way of living. At the end of this age, the modern human being (*Homo sapiens*) first appeared around 36,000 B.C. The **Paleolithic Period** (Old Stone Age) is from 2.5 million-12,000 B.C. with earliest tool-making human beings and ends when people learned to produce higher quality tools around 12,000 B.C. and to farm around 8,000 B.C. The Old Stone Age is the 'Age of food-gatherers', while the New Stone Age (the New Stone Age or the Neolithic Age (12000 to 4000 B.C.)) is referred to as the 'Age of food producers'. This puts the Bronze Age onwards as the 'Age of civilization', starting towards the end of the Neolithic Age. There are three major life-style groupings viz., (i) Hunter gatherer, (ii) Agriculture, and (iii) Technological civilization. Civilization requires, or may be defined by, settlement in definite territories, the building of

towns and cities, the evolution of defined systems of government and the development of trade and commerce. This social system has and does exist together with the first two.

Hunter gatherers - Over the period called the Middle Paleolithic (called the Middle Stone Age in Africa), 200,000 to 40,000 years ago, stone tools found are quite similar, representing a uniform technology world-wide. The oldest site of tool use comes from East Africa where pebble tools were in use 1.7 million years ago. Tool and fire are ancient “landmarks” on the path to humanity. There is evidence that fire was first used by *Homo erectus* at Ghoukoutien, China 300,000 to 400,000 years ago.

Hunter-gatherers had a practical, but excellent knowledge of their natural environment, be it plants, animals or the physical conditions. In productive areas, Australian aborigines had up to 250 food plants from which to choose. Poorer areas had about 50 food plants. Paleolithic (Stone) Age lasted up to 12,000 B.C. Primitive man used tools and implements of rough stone. Man was essentially a food gatherer and depended on nature for food.

Ice Age (Upper Paleolithic - 35,000 to 8,000 B.C.) - During this period, a culture of mammoth hunters lived in Eastern Europe and Siberia. These hunting nomads had a diet mostly of meat as did the Eskimos until recently. All their requirements would have come from their prey which also included bison, horses, reindeer, birds, fish, arctic foxes and hares. Vegetable foods would have formed a minor supplement. They even built huts from carefully interlocked mammoth bones covered with skins. A typical Australian aborigine’s catch for the day may include snakes, lizards, anteaters, frogs and grubs, and a wallaby or two. Semang people of Malaysia rely on small creatures (fish, birds, rats, squirrels, lizards and sometimes wild pigs, tapirs and deer), wild plants (nuts, berries, fruit, leaves, shoots, and tubers) and honey collected from the forest. They use a poisoned dart propelled from a two-metre long bamboo blowpipe to kill some animals.

Beginning of agriculture - Demographic pressure probably led to the adoption of crop cultivation and animal husbandry, leading to modern civilization. As the population grew, there was an increased dependence upon plants. Next, consumer demand within a constrained space forced the adoption of some form of intensive agriculture. Other evidence for this trend is found in Peru where people domesticated camelids and guinea pigs 2,000 years before crop cultivation. Agriculture would have been started with the end of the last Ice Age between 15,000 and 8,000 years ago. Before this, people living the hunter-gatherer lifestyle depended upon what was available. Historical evidences showed that agriculture started around 8,500 years ago from the Near East, reaching Britain around 6,000 years ago and Spain and Portugal by 5,000 years ago. American Indians of central Brazil, called, the Kayapo are a modern version of hunter gatherer people. With chickens, crops such as corn, sweet potatoes, sweet manioc and yams and a hunting lifestyle they represent a transition from a hunter-gathering lifestyle to an agricultural lifestyle. What they caught by hunting, be it a tortoise, deer, fish or a wild pig, they had to share and they discouraged selfishness. Women worked in groups to gather fruit, nuts and plants from the same forest where the men hunt. Ironically, on finding a high fruit tree, they cut it down with a metal axe to harvest the ripe fruit. Domestic crops and animals become more important as food than wild animals and plants. Agriculture is relatively new, only emerging between 12,000 and 8,000 years ago and has often caused environmental damage, but has led to the social changes that have allowed the formation of our modern civilization. The domestication of dogs and turkeys followed agriculture. People made tools such as bone reaping knives with flint cutting teeth (Refer Table 1.1 of Chapter 1).

(ii) **Mesolithic period or Meso stone age** (12,000 to 7,500 B.C.) - The Mesolithic age began and continued up to 4000 B.C. in India. It is characterized by tiny stone implements called microliths. During this time, sharp and pointed tools were used for killing fast-moving animals. The beginning of plant cultivation also appeared. The human beings learned to produce higher quality tools around 10,000 B.C. and to farm around 8,000 B.C. Semi-permanent agricultural settlements took place in Old World. The human culture characterized by cultures moving from a food-gathering society to a food-production society. Tools in this age often had “barbs” or hooks, or interchangeable. The beginning of plant cultivation also appeared. Chotanagpur plateau, central India and south of the river Krishna are some of the various Mesolithic sites.

Table 2.1. The Type of Economy and Culture During the Mesolithic Period-Bronze Age

<i>Period</i>	<i>Type of economy</i>	<i>Type of culture</i>
12000-8500 B.C.	Hunter/gathering economy with more intense use of animals plantings.	Nomadic culture.
8500-7600 B.C.	Exploitation of cattle, pigs, sheep, goats, wheat, barley, peas, lentil, etc., cultivated.	Village development at Jericho barter began burial of dead.
7600-6000 B.C.	Domestication of sheep, goat, expansion range of cultivated crops.	Increase in settlement size. More varied artifacts.
6000-5000 B.C.	Increasing concentration on agriculture and herding as hunting diminished in importance. Cattle and pigs domesticated.	Pottery making began, use of plough.
5000-3700 B.C.	More productive agriculture and herding economy.	Development of copper culture, wider range of pottery styles. Increased population.

(iii) **Neolithic or New Stone age** (7500 B.C. to 6500 B.C.) - The word ‘lithium’ comes from a Greek word, “lithos”, which means stone while ‘Neo’ means ‘new’. Human settlement in the Indian sub-continent is from 7500 to 4000 B.C. Man began to domesticate animals and cultivate plants, settling down in villages to form farming communities. Beginning or discovery of Agriculture takes place in Neolithic period. Agricultural Revolution has occurred in western Asia during the same period. Invention of polished stone implements has taken place. The age in human culture characterized by the use of arrows, *polished* stone tools used in farming, the creation of pottery, weaving cloth and making baskets. In Neolithic period, two major periods were covered *viz.*

I. 8000-6000 B.C.- Early agricultural settlement with domestic architecture and variety of crafts.

- **8000-7000 B.C.-** First phase lacked pottery; people used mostly stone blades, a few ground-stone hand-axes; wheat, barley—staple crops; domesticated sheep and goats; agriculture supplemented by Hunting; mud-brick huts; simple burial rituals.
- **7000-6000 B.C.-** Pottery appears during second phase; domestic cattle replace game animals, sheep, and goats; granaries appear (indicate crop surpluses); more elaborate burial rituals; human figurines modeled in clay.

II. 5000-3000 B.C.- 5500 B.C., a major geologic event took place (earthquake, flood, or shift of tectonic plates)—original site almost completely buried in silt. Original culture persisted, but with alterations: increased use of pottery; granaries larger/more numerous; appearance of several new crafts—use of copper and ivory; size of settlement enlarged. The Chalcolithic period lasted from 4,000 to 2,500 years B.C.

2. Bronze age (4000 to 2000 B.C.) - Chalcolithic culture prevailed in Bronze Age. The term Chalcolithic is applied to the communities using stone implements along with copper or bronze ones. Invention of plough, wheel and metallurgy has taken place. Earliest recorded date in Egyptian calendar was 4241 B.C. First year of Jewish calendar was 3760 B.C. First phonetic writing appears in 3500 B.C. Sumerians develop a city-state civilization during 3000 B.C. Copper used by Egyptians and Sumerians. The most ancient civilization on the Indian subcontinent, the sophisticated and extensive Indus Valley civilization, flourishes in what is today Pakistan. Bronze Age is the period of ancient human culture characterized by the use of bronze; that began between 4000 and 3000 B.C., and ended with the advent of the Iron Age. According to a variety of religious traditions, about 3800 B.C. was the tragic expulsion of “*Adam and Eve*” from the Garden of Eden - sent to practice agriculture.

3. Iron age (1500 B.C. onwards) - The Little Ice age (1450 A.D.–1870 A.D.): Beginning about 1450 A.D. is a marked return to colder conditions, often called. ‘The Little Ice Age’, a term used to describe an epoch of renewed glacial advance. Glaciers advanced in Europe, Asia and North America, whilst sea ice in the North Atlantic expanded with detrimental effects for the colonies of Greenland and Iceland.

2.3 TECHNOLOGICAL CIVILIZATION

The development of a technological civilization is a matter of degree rather than a moment in time. Early Egyptian societies were technological, enabling complex engineering such as the pyramids. Technology has been with humans from the first use of a stone as a tool, as it is with some chimpanzee groups today. With the introduction of agriculture, villages and cities became possible as people did not have to travel in search of food. (*Civilization* comes from the Latin word “*civitas*” meaning city.) This sedentary way of life formed the basis for modern civilization. Egypt and Mesopotamia had established irrigation systems by 5,000 years ago. In China, people developed the iron plough by 2,600 years ago, replacing wood and stone ploughs as a more effective tool. They had also developed the mould board plough by 2,100 years ago. Ancient people are responsible for the basic inventions such as the use of fire, the use of metals such as gold and copper, bows and arrows, the fish hook, spinning and weaving, agriculture, animal domestication, sail boats and ships, wells and irrigation, pottery, clothing, language, arithmetic, the alphabet and written communication in prehistoric times. The oldest evidence for the bow and arrow, at 20,000 years old, comes from North Africa. Other agricultural inventions such as seed drills have older origins, in use in Mesopotamia 5,500 years ago. People built the pyramid at Saqqara over 4,600 years ago. Architects designed complex architectural concepts such as domes, built in Ancient Cyprus 5,000 years ago. The discovery and use of ‘*metals*’ was an important aspect of our cultural evolution. Malleable metals allowed creations limited only by human imagination and so the invention of a far wider range of implements, tools and instruments than could be made with wood and bone. Copper was found in almost pure form in some areas and so was one of the first metals used around 10,000 years ago by the people living along the Euphrates and Tigris rivers in what is now Iraq. Gold was in use by 5,500 years ago. Roman dentists were using gold as tooth fillings 2,000 years ago. Silver was in use 6,000 years ago. Egyptians produced iron, the most difficult metal to separate from its ore, 4,000 years ago. Assyrians had an advanced technology for iron smelting, even making steel from iron. Labourer saving devices was commonly used in ancient Greece. They used the wedge, the lever, the block with pulleys, the winch or windlass and the screw. Scientists such as Archimedes (2,300 years ago) were involved in these developments, but were not the inventors. The screw was used to move water in the Middle East and probably originated in ancient Egypt.

Before A.D. 1,000, two important innovations became established in Europe, the rotation of crops and the horse-drawn and wheeled Saxon plough. Water wheels were in use in England for various purposes such as grinding corn or sawing wood in 1066 A.D. At the end of the middle ages and the beginning of the Renaissance the German, Johan Gutenberg invented printing with movable type. His Gutenberg Bible of 1455 was the first known printed book. In the medieval period, mechanical clock and the watch with balance wheel was invented during 1286.

During the fifteenth century Europeans started exploring and discovering the rest of the world. Columbus reached the Americas in 1492. Bartholomew Diaz reached the Cape of Good Hope on Africa in 1494. Vasco De Gama sailed around the Cape to India in 1497. In 1543, the “De Revolutionibus Orbium Coelestium” of Copernicus established that the earth orbited around the sun. According to Marco Polo, the Chinese inventions include coal as fuel, the use of paper money, printing technology, firearms and the compass during 1271–1292 and none of which was in use in Europe. Our technological era began with the invention of the steam engine and automated regulator devices in the mid-eighteenth century. Water mills remained the main source of mechanical power in England throughout the Industrial Revolution and up to 1830. A wheat thresher was invented in Scotland during 1784. A horse-drawn combine harvester that reaped, separated the chaff and poured the grain into bags was in use in 1830’s. Paper was invented in China around A.D. 100. A practical typewriter was patented in 1868. Blaise Pascal, a French mathematician invented the first automatic calculator in 1642. George Boole, a mathematician developed this into Boolean Algebra and Boolean Logic. This formed the basis for computer logic and computer languages. Fabric weaving was automated in 1801 by J.M. Jacquard, using punched cards. Charles Babbage (1791–1871) tried to develop a mechanical computer, or “analytical engine” using punched cards in the 1830’s. In 1888, an American inventor, Herman Hollerith, developed a successful computer, using punched cards and electricity. This was the first step in automated data processing, generating tabulated results from payroll, census and other data. In 1911 he sold his company, the Tabulating Machine Company, which then became the Computing-Tabulating-Recording Company. They formed IBM from this company in 1924.

Indian History - A Timeline (Ancient)

2700 B.C.	Harappa Civilization
1000 B.C.	Aryans expand into the Ganga valley
900 B.C.	Mahabharata War
800 B.C.	Aryans expand into Bengal; Beginning of the Epic Age: Mahabharata composed, first version of Ramayana
550 B.C.	Composition of the Upanishads
544 B.C.	Buddha’s Nirvana
327 B.C.	Alexander’s Invasion
325 B.C.	Alexander marches ahead
324 B.C.	Chandragupta Maurya defeats Seleucus Nicator
322 B.C.	Rise of the Mauryas; Chandragupta establishes first Indian Empire
298 B.C.	Bindusara Coronated
272 B.C.	Ashoka begins reign ; Exclusive Interview with Ashoka
180 B.C.	Fall of the Mauryas ; Rise of the Sungas
145 B.C.	Chola king conquers Ceylon
58 B.C.	Epoch of the Krita-Malava-Vikram Era

(Contd.)

30 B.C.	Rise of the Satvahana Dynasty in the Deccan
40 A.D.	Sakas in power in Indus Valley and Western India
50 A.D.	The Kushans and Kanishkas
78 A.D.	Saka Era begins
320 A.D.	Chandragupta I establishes the Gupta dynasty
360 A.D.	Samudragupta conquers the North and most of the Deccan
380 A.D.	Chandragupta II comes to power; Golden Age of Gupta Literary Renaissance
405 A.D.	Fa-hein begins his travels through the Gupta Empire
415 A.D.	Accession of Kumara Gupta I
467 A.D.	Skanda Gupta assumes power
476 A.D.	Birth of astronomer Aryabhata
606 A.D.	Accession of Harshavardhan Gupta
622 A.D.	Era of the Hejira begins
711 A.D.	Invasion of Sind by Muhammad Bin Qasim
985 A.D.	The Chola Dynasty: Accession of Rajaraja, the Great
1001 A.D.	Defeat of Jaipal by Sultan Mahmud

Indian History - A Timeline (Medieval)

<i>Year</i>	<i>Particulars</i>
1026	Mahmud Ghazni sacks Somnath Temple
1191	Prithviraj Chauhan routs Muhammad Ghori: the first battle of Tarain
1192	Qutbuddin establishes the Slave Dynasty
1221	Mongol invasion under Genghis Khan
1232	Foundation of the Qutub Minar
1288	Marco Polo visits India
1290	Jalaludin Firuz Khalji establishes the Khalji dynasty
1320	Ghiyasuddin Tughluk founds the Tughluk dynasty
1325	Accession of Muhammad-bin-Tughluk
1336	Foundation of Vijayanagar (Deccan)
1398	Timur invades India
1424	Rise of the Bahmani dynasty (Deccan)
1451	The Lodi dynasty established in Delhi
1489	Adil Shah dynasty at Bijapur
1490	Nizam Shahi dynasty at Ahmednagar
1498	First voyage of Vasco da gama
1510	Portuguese capture Goa
1518	Kutub Shahi dynasty at Golconda
1526	Establishment of the Mughul Dynasty; First Battle of Panipat: Babur defeats Lodis

(Contd.)

1526–1530	Reign of Babur
1530	Humayun succeeds Babur
1538	Death of Guru Nanak
1539	Sher Shah Suri defeats Humayan and becomes Emperor of Delhi
1555	Humayun recovers the throne of Delhi
1556	Death of Humayun; Accession of Akbar;
1564	Akbar abolishes poll tax on Hindus
1565	Battle of Talikota: Muslim rulers in Deccan defeats and destroys Vijaynagar Empire
1568	Fall of Chittor
1571	Foundation of Fatehpur Sikri by Akbar
1572	Akbar annexes Gujarat
1573	Surat surrenders to Akbar
1575	Battle of Tukaroi
1576	Battle of Haldighati: Akbar defeats Rana Pratap; Subjugation of Bengal
1577	Akbar troops invade Khandesh
1580	Accession of Ibrahim Adil Shah II in Bengal; Rebellion in Bihar and Bengal
1581	Akbar's march against Muhammad Hakim and reconciliation with him
1582	Divine Faith promulgated
1586	Annexation of Kashmir
1591	Mughul conquest of Sind
1592	Annexation of Orissa
1595	Siege of Ahmednagar; Annexation of Baluchistan
1597	Akbar completes his conquests
1600	Charter to the English East India Company
1602	Formation of the United East India Company of Netherlands
1605	Death of Akbar and Accession of Jahangir
1606	Rebellion of Khusrav; Execution of the Fifth Sikh Guru, Arjan
1607	Sher Afghan first, husband of Nur Jahan, killed
1608	Malik Ambar takes Ahmednagar
1609	The Dutch open a factory at Pulicat
1611	The English establish a factory at Masulipatnam
1612	The Mughul Governor of Bengal defeats the rebellious Afghans; Mughuls annex Kuch Hajo
1615	Submission of Mewar to the Mughuls; Arrival of Sir Thomas Roe in India
1616	The Dutch establish a factory at Surat
1620	Capture of Kangra Fort; Malik Ambar revolts in the Deccan
1622	Shah Abbas of Persia besieges and takes Qandahar
1623	Shah Jahan revolts against Jahangir

(Contd.)

1624	Suppression of Shah Jahan's rebellion
1626	Rebellion of Mahabat Khan
1627	Death of Jahangir; Accession of Shah Jahan
1628	Shah Jahan proclaimed Emperor
1631	Death of Shah Jahan's wife Mumtaz Mahal; The construction of Taj Mahal
1632	Mughul invasion of Bijapur; Grant of the "Golden Firman" of the English Company by the Sultan of Golkunda
1633	End of Ahmednagar Dynasty
1636	Aurangzeb appointed Viceroy of Deccan
1639	Foundation of Fort St. George at Madras by the English
1646	Shivaji captures Torna
1656	The Mughuls attack Hyderabad and Golkunda; Annexation of Javli by Shivaji
1657	Invasion of Bijapur by Aurangzeb; Aurangzeb captures Bidar and Kalyani
1658	Coronation of Aurangzeb
1659	Battles of Khajwah and Deorai
1661	Cession of Bombay to the English; Mughul capture of Cooch Bihar
1664	Shivaji sacks Surat and assumes royal title
1666	Death of Shah Jahan; Shivaji's visit to Agra and escape
1674	Shivaji assumes the title of Chhatrapati
1678	Marwar occupied by the Mughuls
1680	Death of Shivaji; Rebellion of Prince Akbar
1686	English war with the Mughuls; Fall of Bijapur
1689	Execution of Sambhaji
1690	Peace between the Mughuls and the English
1691	Aurangzeb at the zenith of his power
1698	The new English company trading to the East Indies
1699	First Maratha raid on Malwa
1700	Death of Rajaram and regency of his widow Tara Bai
1702	Amalgamation of English and the London East India Companies
1707	Death of Aurangzeb; Battle of Jajau
1714	Husain Ali appointed Viceroy of the Deccan; The treaty of the Marathas with Husain Ali
1720	Accession of Baji Rao Peshwa at Poona
1739	Nadir Shah conquers Delhi; The Marathas capture Salsette and Bassein
1740	Accession of Balaji Rao Peshwa; The Marathas invade Arcot
1742	Marathas invade Bengal
1748	First Anglo-French war
1750	War of the Deccan and Carnatic Succession; Death of Nasir Jang
1751	Treaty of Alivadi with the Marathas
1756	Siraj-ud-daulah captures Calcutta

Indian history - A Timeline (Modern)

1757	Battle of Plassey: The British defeat Siraj-ud-daulah
1760	Battle of Wandiwash: The British defeat the French
1761	Third battle of Panipat: Ahmed Shah Abdali defeats the Marathas; Accession of Madhava Rao Peshwa; Rise of Hyder Ali
1764	Battle of Buxar: The British defeat Mir Kasim
1765	The British get Diwani Rights in Bengal, Bihar and Orissa
1767–1769	First Mysore War: The British conclude a humiliating peace pact with Hyder Ali
1772	Death of Madhava Rao Peshwa; Warren Hastings appointed as Governor of Bengal
1773	The Regulating Act passed by the British Parliament
1774	Warren Hastings appointed as Governor-General
1775–1782	The First Anglo-Maratha war
1780–1784	Second Mysore War : The British defeat Hyder Ali
1784	Pitt's India Act
1790–1792	Third Mysore War between the British and Tipu
1793	Permanent Settlement of Bengal
1794	Death of Mahadaji Sindhia
1799	Fourth Mysore War: The British defeat Tipu; Death of Tipu; Partition of Mysore
1802	Treaty of Bassein
1803–1805	The Second Anglo-Maratha war: The British defeat the Marathas at Assaye: Treaty of Amritsar
1814–1816	The Anglo-Gurkha war
1817–1818	The Pindari war
1817–1819	The last Anglo-Maratha war: Marathas finally crushed by the British
1824–1826	The First Burmese war
1829	Prohibition of Sati
1829–1837	Suppression of Thuggee
1831	Raja of Mysore deposed and its administration taken over by East India Company
1833	Renewal of Company's Charter; Abolition of company's trading rights
1835	Education Resolution
1838	Tripartite treaty between Shah Shuja, Ranjit Singh and the British
1839–1842	First Afghan war
1843	Gwalior war
1845–1846	First Anglo-Sikh war
1848	Lord Dalhousie becomes the Governor-General
1848–1849	Second Anglo-Sikh war: (Rise of Sikh Power) British annex Punjab as Sikhs are defeated

(Contd.)

1852	Second Anglo-Burmese war
1853	Railway opened from Bombay to Thane; Telegraph line from Calcutta to Agra
1857	First War of Indian Independence: The Sepoy Mutiny
1858	British Crown takes over the Indian Government
1861	Indian Councils Act; Indian High Courts Act; Introduction of the Penal Code
1868	Punjab Tenancy Act; Railway opened from Ambala to Delhi
1874	The Bihar Famine
1877	Delhi Durbar: The Queen of England proclaimed Empress of India
1878	Vernacular Press Act
1881	Factory Act; Rendition of Mysore
1885	First meeting of the Indian National Congress; Bengal Tenancy Act
1891	Indian Factory Act
1892	Indian Councils Act to regulate Indian administration
1897	Plague in Bombay; Famine Commission
1899	Lord Curzon becomes Governor-General and Viceroy
1905	The First Partition of Bengal
1906	Formation of Muslim League; Congress declaration regarding Swaraj
1908	Newspaper Act
1911	Delhi Durbar; Partition of Bengal modified to create the Presidency of Bengal
1912	The Imperial capital shifted from Calcutta to Delhi
1913	Educational Resolution of the Government of India
1915	Defence of India Act
1916	Home Rule League founded; Foundation of Women's University at Poona
1919	Rowlatt Act evokes protests; Jalianwalla Bagh massacre; The Montague-Chelmsford Reforms offer limited autonomy
1920	The Khilafat Movement started; Mahatma Gandhi leads the Congress; Non-co-operation Movement
1921	Moplah (Muslim) rebellion in Malabar; Census of India
1922	Civil Disobedience Movement; Chauri-Chaura violence leads to Gandhi suspending movement
1923	Swarajists in Indian Councils; Certification of Salt Tax; Hindu-Muslim riots
1925	Reforms Enquiry Committee Report
1926	Royal Commission on Agriculture; Factories Act
1927	Indian Navy Act; Simon Commission Appointed
1928	Simon Commission comes to India: Boycott by all parties; All Parties Conference
1929	Lord Irwin promises Dominion Status for India; Trade Union split; Jawaharlal Nehru hoists the National Flag at Lahore
1930	Civil Disobedience movement continues; Salt Satyagraha: Gandhiji's Dandi March; First Round Table Conference
1931	Second Round Table Conference; Irwin-Gandhi Pact; Census of India

(Contd.)

1932	Suppression of the Congress movement; Third Round Table Conference; The Communal Award; Poona Pact
1933	Publication of White Paper on Indian reforms
1934	Civil Disobedience Movement called off; Bihar Earthquake
1935	Government of India Act
1937	Inauguration of Provincial Autonomy; Congress ministries formed in a majority of Indian provinces
1939	Political deadlock in India as Congress ministries resign
1942	Cripps Mission to India; Congress adopts Quit India Resolution; Congress leaders arrested; Subhash Chandra Bose forms Indian National Army
1944	Gandhi-Jinnah Talks break down on Pakistan issue
1945	First trial of the Indian Army men opened
1946	Mutiny in Royal Indian Navy; Cabinet Mission's plan announced; Muslim League decides to participate in the Interim Government; Interim Government formed; Constituent Assembly's first meeting
3-6-1947	Announcement of Lord Mountbatten's plan for partition of India
15-8-1947	Partition of India and Independence

2.4 INDUS CIVILIZATION

The great civilizations of the ancient world are Mesopotamia and ancient Egypt; then come, in mixed order, ancient China, Greece, Central and South America, and the Indus Valley civilization, also called the Harappan civilization. Indian civilization, its ancientness and great cultural traditions go back to the dawn of ages. This civilization was thought to have been confined to the valley of the river Indus, hence the name given to it was Indus Valley civilization. This civilization was a highly developed urban one and two of its towns, Mohenjo-daro and Harappa, represent the high watermark of the settlements. Subsequent archaeological excavations established that the contours of this civilization were not restricted to the Indus valley but spread to a wide area in northwestern and western India. Thus this civilization is now better known as the Harappan civilization. Mohenjo-daro and Harappa are now in Pakistan and the principal sites in India include Ropar in Punjab, Lothal in Gujarat and Kalibangan in Rajasthan. Recent research has shown Sutkagen Dor in Baluchistan next to Iran is the western most known Harappan site. The Indus Valley Civilization stretched across the whole of Sindh, Baluchistan, Punjab, Northern Rajasthan, Kathiawar and Gujarat. This civilization is one of the three great early civilizations that arose in the late fourth and third millennia B.C. around the three large alluvial systems of the Tigris-Euphrates, Nile and Indus rivers. India laid stress on a deep culture without neglected material life. Indian can be proud comparing with Americans or Australians civilization which has taken two centuries old and material achievements.

2.4.1 Physical Data

The Harappan civilization comprises of more than 1,500 settlements, most of them small villages or towns, with only a few large cities. Some of the "villages" covered more than twenty hectares; the cities, in comparison, often extended over some eighty hectares—Mohenjo-daro up to 250 hectares. The southern limit was between the Tapti and the Godavari rivers, while the northern limit was some 1,400 km away in Kashmir (at Manda)—though one site, Shortughai, is found still farther up, in

Afghanistan; as of now, the easternmost settlement stands at Alamgirpur in Western Uttar Pradesh, and the western limits were the Arabian sea and the whole Makran coast, almost all the way to the present Pakistan-Iran border. Harappa is a site on the west bank of Ravi; Kalibangan is a site on the right bank of Sutlej; Amri is a site on the west bank of Indus (close to the Arabian sea); Banawali is located 15 km northwest of Fatehbad, near the Sarasvati river and about 120 km east of Kalibangan; Lothal and Rangpur are sites below the Rann of Kutch.

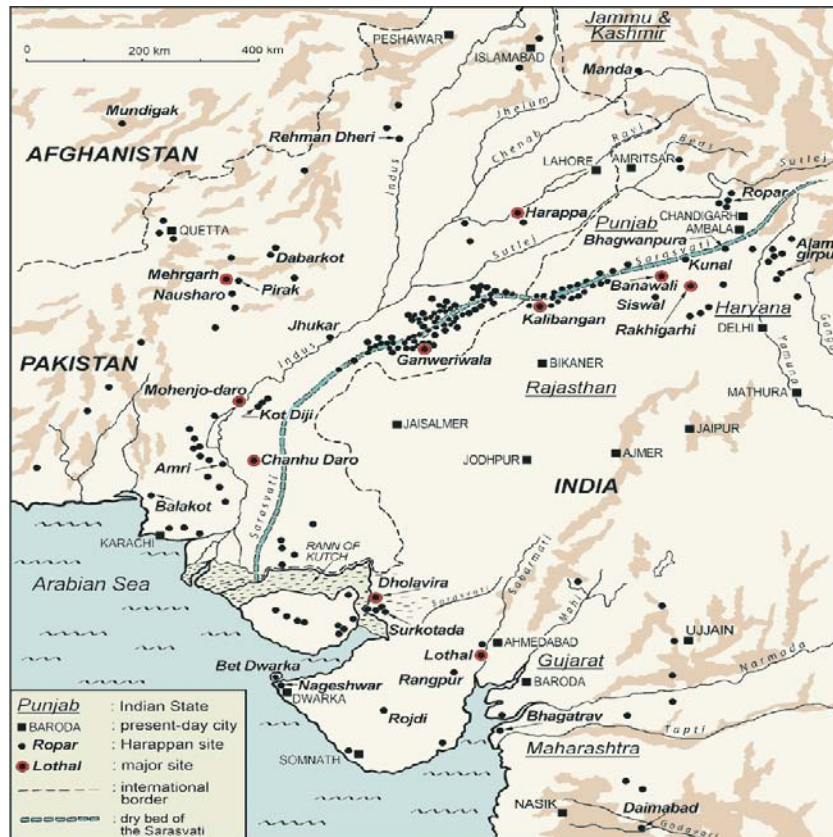

Note- Some of the main sites of the Harappan civilization along the dry bed of the Sarasvati.

Indus or 'Sindhu' civilization comprising the settlements, Mohenjo-daro and Harappa, were found along the river, Ravi and its tributary and on the both sides of the Indo-Pakistan border along the dry bed of a huge river, Sarasvati in the Ghaggar-Hakra valley. The giant sites of Ganweriwala and Lakhmirwala are the known settlements of Kalibangan and Banawali. There are a number of sites in Gujarat, such as Lothal. Satellite photography and recently by radioisotope dating of the water still found under the river's dry bed in the Rajasthan desert. Since the sites found along the Sarasvati far outnumber those in the Indus basin, some scholars have made the point that the Harappan civilization would be better named the '*Indus-Sarasvati civilization*'. The origins of the Indus-Sarasvati civilization are to be found on the subcontinent itself. It no doubt had extensive cultural and commercial contacts with other civilizations, but its identity was distinct. Sarasvati-Sindhu civilization flourished circa 3000 to 1700 B.C. on the river valleys of Indus and Sarasvati rivers. The drying-up of the Sarasvati

river led to migrations of people eastwards to the Ganga-Yamuna doab and southwards from the Rann of Kutch and Pravara (feeder into the Godavari river near Daimabad in Maharashtra) river valley, along the Arabian sea coast. The old Sarasvati river courses from the Sutlej, flowed through Northern Rajasthan, Bahawalpur and Sind found its way into the Arabian Sea via Rann of Kutch in the third to second millennium B.C. Etymologically, Sarasvati means ‘abundance of lakes (saras)’. The synonym of Sarasvati (goddess of vak = speech or language) is brahmi which is the name given to the early scripts used in Asoka’s epigraphs of circa 300 B.C. Jonathan Mark Kenoyer, a U.S. archaeologist, who has worked on many Indus sites, dated 5000–2600 B.C.

2.4.2 River Migrations in Western India

The dried-up bed of Sarasvati might have constituted the great road between Hastinapur and Dwaraka. Geographically, the Sarasvati basin can be traced to the currently known: ghaggar channels. Ghaggar might have been a stream that rose in the Siwaliks and that joined the Sarasvati. This network runs parallel to the Indus across Sind. The river flowed from the Himalayas to the Rann of Kutch. Geologically, the entire Sarasvati riverbed, and the arm of the Arabian sea (formerly spanning into saline Ranns of kutch) into which the river fell are on an earthquake belt; an earthquake could have upraised this entire river-sea-bed profile, drying up the river. This may explain the formation of the Thar desert on the left banks of the river in earlier earthquakes; also, perhaps of the Thar desert in Pakistan. Did some tracts of the Thar desert support cultivation in ancient times? Geological surveys do indicate subsoil water in some tracts. Even today, over 2 million people in Rajasthan live in these tracts! The Sanskrit name is maru-sthall. cf. Tamil maruta-nilam].

The Indus river has a very wide flood plain on either side of its course up to a maximum width of 100–120 km in the east and southeast. To have such a wide flood plain on only one side shows that the Indus river has preferentially migrated towards the north-west in the northern parts and towards the west in the central and southern parts. The study of remotely sensed data in the desert tract of Rajasthan shows that there are plenty of paleochannels with well sprung-up tentacles throughout the desert. On the northern edge of the Thar-Great Indian desert at the Ganganagar-Anupgarh plains a well-developed set of palaeochannels are clearly discernible in satellite photographs. The Sarasvati river once flowed close to the Aravalli hill ranges and met the Arabian sea in the Rann of Kutch that it has migrated towards the west, the northwest and the north and has ultimately got lost in the Anupgarh plains.

“...Remote sensing study of the Great Indian Desert reveals that the Sarasvati river, which is believed to be lost in the desert, could be traced through these palaeochannels as a migratory river. Its initial course flowed close to the Aravalli ranges and successive six stages took west and northwesterly shifts till it coincides with the dry bed of Ghaggar river. The groundwater, archaeological and pedological data with selected ground truths also corroborates these findings. The migration of river Sarasvati seems to be caused by tectonic disturbances in Hardwar-Delhi ridge zone, Luni-Surki lineament, Cambay Graben and Kutch fault facilitated by contrasting climatic variations. The stream piracy by Yamuna river at later stage is responsible for the ultimate loss of water and drying up of the Sarasvati river...”

Climate change - The Indus Valley Culture seen in the context of post-glacial climatic and ecological studies in North-West India: suggests that “...the significant increase in rainfall at the beginning of the third millennium B.C., attested by palaeoecological evidence, played an important part in the sudden expansion of the Neolithic-Chalcolithic cultures in north-west India, ultimately leading to the prosperity of the Indus culture... The present evidence would suggest that the onset of aridity in the region around 1800 B.C. probably resulted in the weakening of the Harappan culture in the arid and semi-arid parts of north-west India...”

2.4.3 Saraswati River Civilization

After the discovery of the first archaeological site at Harappa in 1920, the civilization was referred to as Harappan culture. With the discovery of another major site at Mohenjo-daro in the same decade, it was re-christened as Indus civilization. Since 1950's a number of new type sites have been located. In particular, the sites of Rupar, Kalibangan, Lothal, Dholavira and Banawali. The characteristic feature of the location of these sites is that these are on the banks of or very close to the 'lost' sarasvati river. Hence, the civilization should be re-christened as Indus-Sarasvati civilization. Sarasvati river is extolled in the Rigvedas. Kalibangan and Lothal may not be as grandiose as the urban Harappa but are typical Indus/Sarasvati civilization sites. The lost Sarasvati river course has established the existence of a river flowing down from the Siwalik ranges and also the changes in the courses of the Indus tributaries and the Yamuna rivers. As Yamuna and Sutlej captured the water sources, Sarasvati might have dried up, aided by the upraising of land caused by earthquakes. A part of the river exists as Ghaggar in Haryana; the rest of it has disappeared in the fringes of the maru-sthali or the thar desert.

- (a) **The Cities** - Harappan cities displayed the most sophisticated town-planning. Geometrically designed, the towns had fortifications (for protection against both intruders and floods), several distinct quarters, assembly halls, and manufacturing units of various types ; some bigger cities had furnaces for the production of copper tools, weapons or ornaments ; public baths (probably often part of temples), private baths for most inhabitants, sewerage through underground drains built with precisely laid bricks, and an efficient water management with numerous reservoirs and wells show that the ordinary inhabitant was well taken care of. Mohenjo-daro, for instance, is thought to have had over 700 wells, some of them fifteen metres deep, built with special trapezoid bricks (to prevent collapse by the pressure of the surrounding soil). The Indian archaeologist, B.B. Lal, writes in a recent comprehensive study of this civilization: "*Well-regulated streets [were] oriented almost invariably along with the cardinal directions, thus forming a grid-iron pattern, even the widths of these streets were in a set ratio, i.e., if the narrowest lane was one unit in width, the other streets were twice, thrice and so on. Such a town-planning was unknown in contemporary West Asia.*"
- (b) **Agriculture, Technology and Trade in Harappa during 1600 B.C.** - In the Chalcolithic period, Harappans had reached a high state of culture. They wore cotton garments and used ivory combs and copper mirrors. The women wore ornaments of bronze and gold. They used implements such as sickles, saws, knife blades, spears, axes, arrowheads and daggers made of bronze and copper fish-hooks. Specialized occupation besides agriculture developed and these articles were produced by skilled craftsman such as coppersmiths, carpenters, jewelers, goldsmiths, stone cutters and potters. Trade with other countries especially with Mesopotamia flourished and some items such as metals timber and precious stones were imported. Harappans cultivated bread wheat, barley, sesame, pea, melon, date palm and *Brassica spp.* *Gossypium arboreum* was an important crop, the centre of its origin the Indus Valley. Harappan culture covered a very vast area in north India with very strong settlements at various sites in Jammu and Kashmir, Punjab, Haryana, Rajasthan, Gujarat, Uttar Pradesh and Madhya Pradesh. The rice cultivated in Harappa had long seeded grain and perhaps was the ancestor of the fragrant basmati rice. Wheat and jowar were the other food crops.
- (c) **Neolithic (7500–6500 B.C.) and Chalcolithic (2295–1300 B.C.)** - The main crops under cultivation were jowar, bajra, and ragi (*Eleusine coracana*). Minor millets such as kangni (*Setaria italica*), kundon (*Paspalum milliaceum*) and sannuk (*Echinochloa frumentacea*) were also cultivated. Other crops were kulthi (*Dolichos biflorus*), mung (*Vigna radiata*), mash (urd; black

gram; *Vigna mungo*), masur (*Lens culinaris*), linseed (*Linum usitatissimum*) and castor (*Ricinus communis*), Ber (*Ziziphus nummularia*) and amla (*Emblica officinalis*) were also grown. Wood of teak (*Tectona grandis*), Acacia sp., Albizia sp. and *Ziziphus mauritiana* were used for making agriculture implements and for timber. The wood of *Ziziphus mauritiana* was used for marking moosal (mortar).

The plant domestication, diffusion development in ancient India and borderlands was a gradual transition from full time hunting-foraging practices which took place in several geographical regions and chronological settings, viz., the north western sector, Baluchistan, Pakistan and its borderlands with Iran and Afghanistan during Neolithic period between 8000 and 5500 B.C. In the early Chalcolithic phase (4700–4300 B.C.) wheat, hulled and naked barley was cultivated. Fruits of jujube, prunus and cotton were added to the plant economy besides dates. Practice of high yielding hexaploid wheat (bread, club and dwarf) and barley (hulled and naked) also continued. Crop remains of wheat (emmer, bread, club and dwarf) and hulled barley from 3500 to 3200 B.C. along with apricots. During 3200–2500 B.C., barley (6 row hulled, 6 row naked, 6 row shot) lentil, chickpea, flax/linseed, jujube, grape, cotton and dates were grown. Besides rice, indigenous people of India had domesticated several species of minor millets, grain, legumes, oil seed crops fiber crops, fruits, vegetables and other economic plant species in the Indus–Saraswati Yamuna Ganga valleys. Farmers practiced barely and rice rotation at Atranjikhhera (e.g., 2000–1500 B.C.) in association with grass pea and chickpea. Farmers cultivated rice, black gram and green gram in the rainy season and bread and lentil in winter. The people ate, besides cereals, vegetables and fruits, fish, fowl, mutton, beef and pork. Perhaps the most remarkable achievement was the cultivation of cotton. There was an extensive network of canals for irrigation.

The Sumerians developed the plough about 2900 B.C. Possibly the Harappans learnt the use of the plough from the Sumerians. All primitive ploughs were made of wood, and wood is a perishable material. A terracotta model of a plough, 7 cm × 19.7 cm has been discovered from Mohenjo-daro. This toy plough is kept in the Prince of Wales Museum, Bombay. There is a longish beam and the plough breast terminates in a rectangular manner. There is no indication that it had a handle (*munna*) for the ploughman to hold. The people of Kalibangan had domesticated cattle, and carried on agriculture. To the southeast of the pre-Harappan settlement a ploughed field was discovered. It showed a grid of furrows, with one set more closely spaced (about 30 cm apart) running east-west, and the other widely spaced (about 1.90 metres apart), running north south. This pattern bears a remarkable resemblance to ploughing as is now carried, where mustard and gram are grown in two sets of furrows in the same field.

S.R. Rao in his monograph, *Lothal and the Indus Civilization*, has reproduced a photograph of a seal from Lothal, which he feels depicts a seed drill. But its shape is rather unusual for a seed-drill. Ox-drawn sledges were still being used about 3000 B.C. at Dr to convey royal corpses to their final resting-place. But long before that date, the sledge had been transformed by an invention that revolutionized locomotion on land. The wheel was the crowning achievement of prehistoric carpentry; it is the pre-condition of modern machinery, and, applied to transport, it converted the sledge into a cart or wagon. Wheeled vehicles are represented in the Sumerian art as early as 3500 B.C., and in northern Syria perhaps even earlier. By 3000 B.C., carts, wagons, and even chariots were in general use in Elam, Mesopotamia and Syria. In the Indus Valley, wheeled carts were in use when the archaeological record begins about 2300 B.C. and at about the same date in Turkistan too. Children's toys from Mohenjo-daro, Harappa, Lothal and Chandigarh include some wheeled carts, which indicate that they were in use in ordinary t-life.

Bronze models of carts have also been found at Harappa. The people made extensive use of the wooden plough. Kalibangan even yielded a field ploughed with two perpendicular networks of furrows, in which higher crops (such as mustard) were grown in the spaced-out north-south furrows, thus casting shorter shadows, while shorter crops (such as gram) filled the contiguous east-west furrows. This is a technique still used today in the same region. There is also evidence of the domestication of cats, dogs, goats, sheep and perhaps, the elephant.

Indus civilization society capable of town-planning, shipping, refined arts and crafts, writing, sustained trading, necessarily has to master a good deal of technology. *Symbols of Indus religion and culture were incorporated into pottery, ornaments and everyday tools in a way that helped to unite people within the urban centers and link them with distant rural communities.* The cotton textiles, ivory and copper were exported to Mesopotamia, and possibly China and Burma in exchange for silver and other commodities. Production of several metals such as copper, bronze, lead and tin was also undertaken. The Indus people did not know iron. The people were very artistic in the pottery, stone sculpture and seal making. The discovery of kilns to make bricks support the fact that burnt bricks were used extensively in domestic and public buildings. The people had commercial links with Afghanistan, Persia, Egypt, Mesopotamia and the Samaritans. Trade was in the form of 'barter'. There was a cleverly organized system of weights and measures.

- (d) **Government and social evolution** - The Harappan political organization as an empire, with Mohenjo-daro as the seat of the emperor and a number of "governors" in the regional capitals, others are in favour of regional states. Mohenjo-daro is thought to have sheltered at least 50,000 inhabitants.
- (e) **The Aryan problem** - The relationship of the Indus-Saraswati civilization with the later Indian civilization remains a subject of debate. The ancient dwellers in India were Dravidians, and in fact, their culture had developed a highly sophisticated way of life. The existence of the Brahui tribe in Baluchistan, to the west of the Indus, who speak a Dravidian language like South Indian Tamil, gives evidence that a migration of people or culture did occur. The language of Indus Valley civilization appears to be Dravidian akin to Old Tamil, presently spoken throughout the southern part of the Indian Peninsula. Maru is the Sanskrit name of the desert that lies between the Indus-Saraswati river valleys of south Asia. It is also called 'thar' in India and 'thal' in Pakistan. The habitation 'Maru' land was once marsh, the Indus-Saraswati river valley inundated area, which supported agriculture. Similarly the word 'Maru' as marsh-land, river valley is used as 'marutam' indicating the agricultural tracts in Tamil language. A study of the evolution of scripts in India indicates that the Dravidians, over the centuries, have made the key contributions to the development of language and literature in India.

The theory of an Aryan invasion or even migration into India is as follows:

1. The Aryans migrated from their original home in Europe or Central Asia. The Harappan towns were destroyed by semi-barbarian Aryans rushing down on their horse chariots. The Aryans are said to have entered India through the Khyber Pass and invaded or perhaps more peacefully intermingled with the Indus Valley peoples at least since 1600 B.C., and perhaps earlier. The Aryans cross the River Sindhu and settled in a region called Saptasindhu, or the land of seven rivers (now known as the Punjab, the land of five rivers). The Aryans were Indo-European warlike herders from Asian steppes. Bronze users and horse handlers, Aryans had a superior military and their cavalry warfare enabled them to spread their culture

from the Punjab across northern India, preparing the way for emergence of large empires. The Aryans had a complex cosmology and knowledge of astral sciences—astronomy considered central to Aryan statecraft. Aryans spoke the Sanskrit language (the basis of a majority of Indian languages today), had a polytheist religion (one basis of Hinduism) with a rich pantheon of deities, and a stratified class system: with Kshatriyas (warriors) to rule, and Brahmins (priests and teachers) at the top of the social hierarchy, supported by Vaisyas (farmers) and the Sudras (outcasts). Aryans had driven the inhabitants Dravidians of Saptasindu to South India. These ancient dwellers in India were Dravidians, and in fact, their culture had developed a highly sophisticated way of life. The existence of the Brahui tribe in Baluchistan, to the west of the Indus, who speak a Dravidian language like South Indian Tamil, gives evidence that a migration of people or culture did occur. Also the Harappa religion shows many similarities with those elements of Hinduism, which are especially popular in the present Dravidian culture.

2. Raymond and Bridget Allchin, archaeologists, now admit that the arrival of Indo-Aryans in Northwest India is “*scarcely attested in the archaeological record, presumably because their material culture and life-style were already virtually indistinguishable from those of the existing population.*”
3. British anthropologist, Edmund Leach also termed the Aryan invasion theory as being born out of European racism.
4. Jim Shaffer, 1984 wrote: “*Current archaeological data do not support the existence of an Indo-Aryan or European invasion into South Asia any time in the pre- or protohistoric periods. Instead, it is possible to document archaeologically a series of cultural changes reflecting indigenous cultural developments from prehistoric to historic periods.*”
5. Kenoyer, whom I quoted earlier, concludes in his recent beautiful book : “*Many scholars have tried to correct this absurd theory [of an Aryan invasion], by pointing out misinterpreted basic facts, inappropriate models and an uncritical reading of Vedic texts. However, until recently, these scientific and well-reasoned arguments were unsuccessful in rooting out the misinterpretations entrenched in the popular literature. [...] But there is no archaeological or biological evidence for invasions or mass migrations into the Indus Valley between the end of the Harappan Phase, about 1900 B.C. and the beginning of the Early Historic period around 600 B.C.*”
6. Kenneth A.R. Kennedy, a U.S. expert who has extensively studied such skeletal remains, observes : “*All prehistoric human remains recovered thus far from the Indian subcontinent are phenotypically identifiable as ancient South Asians. [...] In short, there is no evidence of demographic disruptions in the north-western sector of the subcontinent during and immediately after the decline of the Harappan culture.*”
7. No invasion or migration caused or followed the collapse of the urban phase of the Indus-Sarasvati civilization around 1900 B.C. The Harappans were just North-western Indians of the time and continued to live there even after the end of the urban phase (with some of them migrating towards the Ganga plains in search of greener pastures).
8. Dr. B.R. Ambedkar, famous for his work on the Indian Constitution, as well as his campaign in support of the nation’s dalit community noticed the racial overtones underlying the theory and described the British espousal of the Aryan Invasion theory in the following words: “*The theory of invasion is an invention. This invention is necessary because of a gratuitous assumption that the Indo-Germanic people are the purest of the modern representation of the original Aryan race. The theory is a perversion of scientific investigation. It is not*

allowed to evolve out of facts. On the contrary, the theory is preconceived and facts are selected to prove it. It falls to the ground at every point."

The Aryans, or Vedic Civilization

- Pre-Vedic Period (Before 3100 B.C.)
- Vedic Period (1st Phase 3100 B.C.)
- Vedic Period (2nd Phase 2150 B.C.)
- Vedic Period (3rd Phase 2150 B.C.–1400 B.C.)
- Vedic Jyotish Period (1400 B.C.–1200 B.C.)

The Aryans called themselves the “noble ones” or the “superior ones” to distinguish themselves from the people they conquered. Their name is derived from the Indo-European root word, “ar,” meaning “noble.” In Sanskrit, they were the “Aryas” (“Aryans”); but that root, “ar,” would also serve as the foundation of the name of the conquered Persian territories, “Iran.” This concept of nobility, in fact, seems to lie at the heart of Indo-European consciousness, for it appears in another country’s name, “Ireland,” or “Eire.” The Aryans were a tribal and nomadic peoples living in the steppe lands of Euro-Asia. They were a tough people, fierce and war-like. Their culture was oriented around warfare. They were ruled over by a war-chief, or ‘raja’ (the Latin word “rex” (king) comes from the same root word, along with the English “regal”). They travel on horseback and rushed into battle in chariots. They began to migrate southwards in waves of steady conquest across the face of Persia and the lands of India in 2000 B.C. They swept over Persia with lightening speed, and spread across the northern river plains of India. They penetrated India from the north-west, settling first in the Indus valley and then along the Ganges floodplain. The Aryans, or Vedic civilization (Rigvedic Period 1700–1000 B.C.) were a new start in Indian culture. These tribes spread quickly over northern India and the Deccan. Rig Veda is believed to represent the Indo-European religion and have many characteristics in common with Persian religion since the two peoples are closely related in time. In this early period, their population was restricted to the Punjab in the northern reaches of the Indus River and the Yamuna River near the Ganges. They maintained the Aryan tribal structure, with a *raja* ruling over the tribal group in tandem with a council. Each *jana* seems to have had a chief priest; the religion was focused almost entirely on a series of sacrifices to the gods. The Rigvedic peoples originally had only two social classes: nobles and commoners. Eventually, they added a third: *Dasas*, or “darks.” These were the darker-skinned people they had conquered. The word ‘*Varna*’ is used in the Rig Veda never refers to the *Brahmana* or *Kshatriya*.

By the end of the Rigvedic period, social class had settled into four rigid castes: the ‘*caturvarnas*’, ‘*Varna*’ or “*four colours*.” At the top of the *caturvarnas* were the priests, or ‘*Brahmans*’. Below the priests were the warriors or nobles (*Kshatriya*), the craftspeople and merchants (*Vaishya*), and the servants (*Shudra*), who made up the bulk of society. In the early centuries of ‘*Later Vedic Period*’ or ‘*Brahmanic Period*’ (1000–500 B.C.), the Aryans migrated across the Doab, which is a large plain, which separates the Yamuna river from the Ganges. The Later Vedic Period is the ‘Epic Age’; the great literary, heroic epics of Indian culture, the ‘*Ramayana*’ and the ‘*Mahabharata*’, though they were composed between 500 and 200 B.C., were probably originally formulated and told in the Later Vedic Period. The most ancient sacred Aryan literature of Hinduism is called the *Vedas*. The *Vedas* consist of four collections called the *Rig-Veda*, the *Sama-Veda*, the *Yajur-Veda*, and the *Atharva-Veda*. Collectively, these are referred to as the *Samhitas*. The *Rig-Veda* mentioned ‘*Indra*’, the god of war and weather, ‘*Agni*’, the god of fire. The hierarchy of the gods was from Indra and Varuna to the two current sects of Hinduism, which worship Vishnu and Shiva. The best of the Vedic *Shlokas* refer to a common life-spirit that links all living creatures, to human social-interconnectedness, to the notion of unity in

diversity and how different sections of society might have different prayers and different wishes. The *Upanishads*, the *Sankhya*, and the *Nyaya-Vaisheshika* schools, the numerous treatises on medicine, ethics, scientific method, logic and mathematics clearly developed on Indian soil as a result of Indian experiences and intellectual efforts. Siddhartha Gautama (c. 563 B.C.–483 B.C.) founded the religion, which is known as Buddhism. Western scholars frequently list Vardhamana Mahavira (c. 540 B.C.–468 B.C.), as the founder of Jainism.



(Clockwise from top left:) A terracotta figurine from Harappa, in a yoga posture; seals depicting a Shiva-like deity, a unicorn, and a bull.

In 331 B.C., Alexander the Great of Macedon began one of the greatest conquests in human history. After conquering Egypt, Persian Empire, Mesopotamians, Gandhara (Afghanistan), he came into contact with cultures to the east, such as Pakistan and India. The plain region of Gandhara lies directly west of the Indus River. When he tried to push on past Pakistan, his army grew tired, and he abandoned the eastward conquest in 327 B.C. Alexander had literally no effect on Indian history and he left as soon as he reached the Indus. Two important results arose because of Alexander's conquests: first, from this point onwards Greek and Indian culture would intermix. Secondly, the conquest of Alexander may have set the stage for the first great conqueror of Indian history, Chandragupta Maurya (reigned 321–297 B.C.), who, shortly after Alexander left, united all the kingdoms of northern India into a single

empire. While Chandragupta Maurya built his empire by the force of his arm, Kautilya, a shrewd and calculating Brahman, designed the government. Together they created the first unified state in Indian history.

The Vedic period is a period of cultural mixing of Aryans and indigenous people. Vedic culture was native to the Indian subcontinent. Rig-Veda mentions a few symbols used in later Indian culture, such as the trishul or the swastika, the pipal tree or the endless-knot design, are found in the Indus-Saraswati cities. Kalibangan also shows a ploughed field and fire-altars. The Vedic period had weavers; the words *siri* and *vayitri* denote a female weaver. Gold was highly valued. Rigveda refers to *niskagriva*, which is a golden ornament on the neck and necklaces of gold reaching down to the chest. The Vedic people had used ships to cross oceans. The Saraswati-Sindhu rivers supported the cultivation of wheat and barley. The ploughshare ploughing makes the food and feeds the people. Many Vedic people were herdsmen, pastoralists on Saraswati, the mother of the Sindhu. The river flows copiously and fertilizing, bestowing abundance of food, and nourishing (the people) by their waters.

Rig-Veda praised the hundreds of settlements along the Saraswati river confirms again the identification between Harappans and Vedic people. The Vedic homeland was the *Saptasindhu*, which is precisely the core of the Harappan territory. As for the Sangam tradition, it is equally silent about any northern origin of the Tamil people; its only reference is to a now submerged island to the south of India, *Kumari Kandam*, and initial findings at Poompuhar show that, without our having to accept this legend literally, we may indeed find a few submerged cities along Tamil Nadu's coast; especially at Poompuhar and Kanyakumari, where fishermen have long reported submerged structures.

Status of Agriculture

1. **Vedic period (1600 B.C.–1000 B.C.)** - The early home of Aryans was in south Russia in the steppes between the Danube the Volga, and the Urals. There was another verse that the homeland of Aryans was Germany. The Aryans left this homeland during 1600 B.C., and dispersed east and west in large groups. Early Vedic Aryans were primarily pastoral and settled in Indus valley. They cut jungles, built their villages, grazed their cattle in jungles and planted barley in the land close to their habitation. Vedic Aryans were accustomed to cows, horses; buffalo was a new animal, which they called *gouri*, or *govala*, which appears to be an extension of the word *gau* (cow). Indus valley is the land of seven rivers was called 'Saptasindhavah'. The seven rivers included the five rivers of the Punjab (meaning land of five rivers) viz., the Sutudri (Sutlej), the Vipas, (Beas), the Parushini (Ravi) and the Askini (Chenab) and the remaining two includes the Indus and Saraswathi. Aryans began to move in search of water when the river Saraswati dried up. It was king Bhahirath whose efforts brought the Ganga into the plains of India and storage cultures in the Indo-Gangetic plains developed. The Aryans have been identified as nomads they always moved in search of pasturelands for their animals. Their culture has been based on met, camped and departed. This culture is superior to that of the people who were already living for millennia in India and had developed agriculture. Domesticated animals made strong settlements and created a class of artisans and craftsman. One of the strong arguments in the favour of Aryan invasion from the steppes in Russia is the introduction of horse in India by them. When during the Chalcolithic period, trade with Mesopotamia and other cultures was being carried out, the horse could have been brought to India while cotton cloth and other articles were exported. Even during the time of Chandragupta Mayurya, in the bazaars, horses brought by traders from the Middle East were on sale.
2. **Rigveda** - Rigveda the oldest book that was compiled around 3700 B.C. At the beginning of the cropping season, the ploughing was done with great fanfare associated with several rituals.

There are several hymns address to Shuna, Sita and Shunshira. Sita has been referred to as the goddess of the early and also the share of the plough. Barley (yava), sesame and sugarcane were the main crops. As a husbandman repeatedly ploughs the early for barley; causing the barley to be sown in fields properly by the plough; and the cattle feed upon the barley. Harvesting proceeded with prayers. It was mostly done with a sickle by cutting the crops at the ground level or by cutting the ear heads only.

- (i) **Environment (Rigveda)** - The sun destroys all non-visible poisonous creatures is a reference to nocturnal poisonous creature such as snakes and scorpions. The sun is the protector, the purifier and the source of prosperity. The water cycle is described as water going up from earth in the summer through evaporation, cloud formation and water coming down again in the form of rain. Loss of surface water in summer must have been easy to observe. There are six seasons in a year; namely Grishma (May–June), Varsha (July–August), Hemant (September–October), Sharad (November–December), Shishir (January–February) and Vasant (March–April). The beginning of the rainy season (obviously in Pakistan North–West India) is after 21 June when the sun starts ‘moving south’. There existed of dams on the seven rivers. Constructing dams on rivers must have meant cutting off water to Vedic people to irrigate lands and to provide water to people and animals after the rains the contribution of rivers to increasing the food production.
- (ii) **Farming resources and practices (Rigveda)** - A farmer plows his fields repeatedly. Sun brought six seasons, which repeat in a sequence. Bullock cart and chariot were used for crossing Sutlej and Vyas rivers. Tie bullocks to the plow, join yokes, sow the seed, let the food produced be sufficient and let the sickle fall on the ripe crop. Sumps were constructed to provide drinking water for animals, leather ropes and irrigation from never-drying pits. Field operations to raise crops were well established. Using a plow to cultivate land and raise barley was already an “ancient practice” for the Vedic Aryans. Soils of different kinds and productive and non-productive fields were recognized. Soil preparation was done through repeated plowings. Classification of seasons into six different kinds as is followed even today was done. A bamboo stick of a specific size was used for measuring land. Soaking of soil profile with water was carried out to facilitate plowing and sowing operations. Well water was used for drinking purpose but irrigation from shallow wells was practiced. Reference to irrigation possibly from rivers was found. Bullock power was used for plowing and for pulling bullock carts and chariots to cross-rivers such as Sutlej and Vyas undoubtedly in the post rainy season. Labourers were available for work. Other farm operations included bird scaring, harvesting with sickle, threshing, winnowing with titau (suba), storing gains in storage bins and burning of trash/wastes. Barley was ratooned on residual moisture possibly for fodder after harvest of grain crop. Apart from barley, other cereals were consumed. Barley was roasted obviously to make saktu (sattu or flour from roasted barley grain).
- (iii) **Forestry (Rigveda)** - Trees such as pippala (peepal), khadir, shisham palasa shalmali and urvaruka are mentioned. Pippala is treated as sacred tree. Urvaruka fruits are edible. Khadir and shisham wood used for making chariots are used even today to make furniture. Several grasses are mentioned. Some of which are still used in religious ceremonies and in making rope, mats cottage roofs etc.
- (iv) **Animal husbandry (Rigveda)** - A cow having a copious stream of milk yields, in the presence of their calf. Do not kill a cow who is mother of Rudras, daughter or Vasus, sister of Aditya, milk-bearing innocent and without any complex. Various animals referred in

Rigveda include cows and horses, sheep and goats, donkey and camel. Two colours of cows are mentioned black and red. Cows with a long nose seem to have been preferred. Camels, donkeys and horses were used for riding and possibly for carrying loads. Stealing cows is referred in Rigveda considering the fact that cattle meant wealth. Cows belonging to enemies were looted. Chickpea was used as a horse feed because even today water-soaked chickpea is considered to be a good feed for horses. Cleaning of horses was obviously preferred. On management of cows, grazing in forests seems to have been common practice. Cows were permitted to graze in barley fields and cattle owners apparently knew the benefits of providing clean safe water from ponds. Dogs were used for managing herds of cows and for recovering stolen cows. Calling cows for milking with some grass in hand by the boys obviously looked after cows while they grazed. Burning of dried cow dung is practiced as fuel for fire. Killing of cows was clearly discouraged not only because it played an important part in human subsistence, but also for the cow's innocence.

In the later Vedic period (1000–600 B.C.), agriculture implements were improved. Iron ploughshares were used.

3. **End of the Indus civilization** - After 1750 B.C., the Mohenjo-daro and Harappan culture slowly declined and gradually faded out. The cause or causes of the end of the Indus civilization are not easy to determine. Some ascribe this to the decreasing fertility of the soil on account of the increasing salinity, caused by the expansion of the neighbouring desert. Others attribute it to some kind of depression in the land, which caused floods. At Mohenjo-daro groups of sprawling skeletons in this period suggests some sort of massacre or invasion. The destroyers of the Indus cities were members of the group of tribes whose priests composed the Rig Veda. The Indus Valley culture moved from west to east of Ganga-Jamuna-Doab region, with sites towards central and southern India flourishing after Harappa and Mohenjo-daro had declined. The Ramayan partly unfolded the tale of the Aryan advent into the south. Even though there are various theories for the downfall of this civilization, there is no clear picture as to how or why it came to an end.
4. **Status of farmers in society** - Agriculture and Animal Husbandry began to be developed in India from pre-Vedic times. In *Rigveda*, there was reference to hundreds and thousands of cows; to horses yoked to chariots; to racecourses where chariot races were held; to camels yoked to the chariots; to sheep and goat-offered as sacrificial victims, and to the use of wool for clothing. The famous Cow-Sukta indicates that the cow had already become the very basis of rural economy. In another Sukta, she is deified as the mother of the Vasus, the Rudras and the Adityas, as also the pivot of immortality. The Vedic Aryans appear to have large forests at their disposal for securing timber, and plants and herbs for medicinal purposes appear to have been reared by the physicians of the age, as appears in the *Atharva Veda*. The farmers' vocation was held in high regards though agriculture solely depended upon the favours of Parjanya, the god of rain. His thunders are prescribed as food bringing. Tree planting and preservation was one of the fundamental articles of Hindu religion, for the Indian culture from its inception grew under the shades of trees where the Rishis dwelt. Different kinds of trees and their importance in life, for use as well as beauty, were studied with great care. In social rank, the farmers were considered next to Brahmans, and the entire village administration appears to have been in the hands of leading farmers who were known as "**Kutumbin**", from which the word "**Kunbi**" is derived. Even in the **medieval period** under the Hindu rulers, ample evidence for testifying to the expert skill in raising crops such as wheat, gram, pulses, barley, sugarcane, indigo, cotton, pepper and ginger,

and in the rearing of fruits like pineapple, oranges and mangoes. The farmers only paid 1/6th to 1/12th of their agricultural products to the State.

1. *Arthashastra* - Uses the same epithet to describe the qualities of a good country. The advance made in irrigation may be imagined from the anecdote that when a teacher sent his pupil to stop a breach in the water-course of a certain field, the latter had to lie down to stop the flood and prevent vital injury to the crops. The position is confirmed by a parable the implication of which is that guards were employed at the vital spots of embankments, the rupture whereof would cause a great flood and damage. The King should be vigilant at danger-gates as at the dam of a large water-work.

Arthashastra significantly recommends upland (sthala) and low land (kedara) to be entered separately in the field register of the *gopa* and enjoins a three-fold gradation of villages after the manner of Gautama and Manu upon the revenue officer (Samahartar; Sukraniti). This together with a similar reference in Sukraniti, indicates that differential rates for different classes of soils are intended. The Agnipurana again mentioned revenue rates for different kinds of paddy crops. Thus the land assessment varied according to the quality of land and the nature of the crop, the *sadbhaga* was only a traditional or average rate, not the fixed or universal rate, in this respect resembling somewhat the 'tithe' in European fiscal terminology. A careful gradation of land, survey and measurement, calculation of out turn as well as expenses per unit of land was mentioned in Manu, the Arthashastra and the Sumaniti. The king's share did not necessarily mean a fixed share. It was determined by consideration of fertility of the soil and by the needs of the State or of the cultivator. The system of measurement and survey and differentiation of soil according to productivity also indicates that land revenue assessment was not permanent but revised at intervals although a constant revision was not necessary. In Buddha's time irrigation contrivances hardly excelled the old Vedic mechanisms; water was drawn by means of the lever, (tulam), the bullock-team.

2. *Peasant's under Mughal rule* - The Arabs were also innovators in agriculture. They had improved systems of irrigation. They wrote scientific treatises on farming. They excelled in horticulture, knowing how to graft and how to produce new varieties of fruits and flowers.

Ibn Battuta (The Traveller of Islam): He traveled over the greater part of Asia, and visited India in the regime of Muhammad-bin-Tughlak.

- (i) *Peasant economy* - Of the produce of land, a large share went to the State in the form of the land-tax and various perquisites. Of the remainder, a customary share was fixed for various classes of domestic and other labourers. The peasant and his family kept the rest for their own use. A certain proportion went to the share of the priest and the temple. The carpenters, the smiths, the potters, the washerman, the scavengers, etc., were better off as they had to incur no expenditure, e.g., on feeding of livestock, and payment in cash and kind to agricultural labourers.
- (ii) *Trade* - The official weights under the Sultans of Delhi were fixed at an average of 28.78 Ib (13.05 kg) to a mound.
- (iii) *Land revenue cess and taxes* - The land-tax during Arab rulers was usually rated at two-fifths of the produce of wheat and barley, if the fields were watered by public canals; three-tenths, if irrigated by wheels or other artificial means; and one-fourth, if altogether unirrigated. If arable land was left uncultivated, one-tenth of the probable produce has to be paid. Of dates, grapes and garden produce, one-third was taken, either in kind or money; and one-fifth (khums) of the yield of wines, fishing, pearls, and

generally of any product not derived from cultivation, was to be delivered in kind, or paid in value, even before the expenses had been defrayed. The Land-tax was the main source of revenue in Mughal India.

The objects of **Akbar's revenue system** were firstly to obtain a correct measurement of the land. Secondly, the amount of the produce of each bigha of the land was too ascertained and to fix the proportion of that amount that the cultivator should pay to the government. Thirdly, to settle an equivalent for the proportion so fixed, in money. The Land-tax was the main source of revenue in Mughal India. Status of farmers, however, changed with the establishment of the Turkish rule. "If an Empire has to stay, farmers should be exploited", said **Allaudin Khilji**, who used to collect half of the earnings of the farmers. Except during the short period under Akbar, who elaborated the land reforms outlined by Sher Shah, exploitation of the farmers became the rule. Naturally, the status of the farmers suffered and his skill came to be restricted to traditional methods.

The flight of peasants from the land intensified during the reign of Aurangzeb. As the peasants number decreased, the income of the assignees, the *jagirdars*, was reduced. The *jagirdars*, to make good their loss, put increased pressure on the working peasants. Moreover, the practice developed of selling governments of provinces for immense sums in hard cash. Hence, it naturally became the principal object of the individual thus appointed Governor, to obtain repayment of the purchase-money, which he had borrowed at a ruinous rate of interest. This in turn resulted in more repression on the cultivators.

2.4.4 Status of Farmers in Southern India

The Indian Council of Agricultural Research published a book entitled 'Sons of the Soil' in 1941 in which status of the farmers of the different States of India had been discussed. The southern states of India, Andhra Pradesh, Karnataka (Mysore), Tamil Nadu (Madras) and Kerala are separated from the Indo-Gangetic alluvial area of North India by the forest-covered, rocky and comparatively barren and dry forestland, of central India, now called Madhya Pradesh. People from the North, who have not traveled in south India, can have no idea of the beauty of the landscape, the fertility of the soil, and the rich cultural background of the population of South India. Here the ancient hindu cultural, which has largely disappeared from North India, lies preserved in its pristine beauty. The ancient mountain systems of the Western and Eastern Ghats represent the most ancient mountain system of the world, dating back to the beginning of life itself in the Archazoic period. It lacks the snow peaks and glaciers of the Himalayas. These blue purple hills, studded with rich plantations of tea, coffee and rubber. In the foot hills areca palms are cultivated. As proceed towards the seacoast, coconut plantations, paddy, plantains and sugarcane are being grown. The State of Kerala is known as the '*Land of the Coconut Palm*' while Tamil Nadu can rightly be called the '*Land of Palmyra Palm*'. The Blue hills of the Eastern Ghats provide a heavenly contrast with emerald green of paddy fields, and in between them are rows and rows of Palmyra palms with dark trunks bearing clusters of palmate leaves. The women carried out most of agriculture operations like transplanting of paddy, weeding and hoeing, digging groundnut, or scraping grass, etc. As compared with North India, the villages in South India are comparatively much cleaner. The district of Coimbatore can claim to be one of the most progressive districts in India. The Agricultural College, with its longstanding tradition of good research, has made a contribution to the progressive agriculture of this area. However, the credit mainly goes to the farmers themselves, the Naidus and the Gounders, who are always ready to adopt some useful improvements. Agriculture in this district really represents the triumph of man over adverse circumstances and is hence all the more

praise-worthy. They dig tank—like wells, boring through the hard rock to provide irrigation to their fields the siphon system of irrigation with concrete towers for storage of water located in different parts of their farms interconnected with under ground cement pipes enables them to irrigate land at different levels. Line sowing is common and application of green manures, tank mud, and fertilizers is very popular. Give a Naidu a barren piece of land, and by careful soil management he will convert. Most of the well-to-do farmers are also industrialists who have set up small spinning mills. They not only invest the savings from industry in agriculture, but also apply techniques of industry in their farms, which are run on commercial lines. Even small farmers have adopted a diversified system of agriculture combining cultivation of plantains, sugarcane and cotton with paddy. *Glyricidia* and *Sesbania* are grown as hedge plants in many farms. All operations in the cultivation of paddy can be seen going on at the same time in the same village. While in one field nursery is being raised, in another transplanting is being done, and in yet another harvesting is going on. This is on account of the tropical climate with more or less the same temperature all the year round. The land being usually wet, the roads are commonly used for drying paddy and millets. As one travels in the districts of Madurai and Ramanathapuram, one can see paddy drying on the road with a woman keeping a watch. The passing vehicles are usually careful not to trample over the drying grain. Leaving aside the huts of the landless labourers, which are thatched with Palmyra leaves, the houses of the landowners are pucca, roofed with red tiles, and usually white washed. Near the entrance of the village enormous images of horses are seen. These are the ride of the guardian deity of the village known as Ayanar. Near some of the villages are sometimes hundreds of baked clay images of horses; these are the offerings of the grateful villagers who have benefited from the grace of Ayanar who has saved the suffering bullock from disease, or a child from a serious malady. Scare-crows with ugly human faces are also common in the fields. Apart from saving the crop from herds and jackals, they are also said to be efficacious against the evil eye of jealous neighbours. The most interesting festival in Tamil Nadu is the festival of Pongal, when the farmers wash their cattle and decorate the horns of their bullocks. A crowd of villagers dressed in their best cloths proceeding in groups to the village temples. A distinctive feature of the landscape of Karnataka is of with plantations of coconut and arecanut and numerous irrigation tanks. The evergreen forests of Western Ghats in Karnataka have bamboos and coffee gardens. While the people of Mohenjodaro print or carve their special breeds on their seals, the people of Karnataka built a gigantic memorial in honor of the Nandi bull, the ride of Shiva. In the famous temple of Halalebid, Krishna is shown playing the flute while a herd of Hallikars breed with elongated pointed horns surround Him spell bound by the music of the flute. Andhra Pradesh is one of the young States of India. The Kammas and Reddys are intelligent farmers who knew the use of fertilizers and line sowing long ago. Tobacco, chillies, turmeric and groundnut are being cultivated on scientific lines adopting all the improved methods, which the agricultural scientists are advocating. Their soil management is so good that by the application of green manures, organic manures and fertilizers. It is the Naidus and Reddies from Andhra area who migrated in ancient times to Karnataka and parts of Tamil Nadu, and wherever they settled, they raised the level of agriculture. One of their distinctive traits is sincerity and boldness with which they express their views. In fact, their frankness is really refreshing in this age of hypocrisy. The State of Kerala is unique in India in its landscape as well as crops. The homes of the people even in the towns are surrounded by a patch of land in which coconut palms are grown as well as vegetables for home consumption. The red soil of Kerala and its vast plantation of coconut palms give it a distinctive character. Beautiful temples and neatly built churches studded all over the countryside are a testimony of the culture of the people. Farmers of Punjab are really the best farmers in India and were responsible for developing the colonies in the canal-irrigated areas of West Punjab.

2.4.5 Advice by Sages to Kings

Lands may be confiscated from those who do not cultivate them and given to others; or may be cultivated by village labourers and traders, let those owners who do not properly cultivate the land might pay less (to the government). If cultivators pay their taxes easily, they may be favourably supplied with grains, cattle, and money. The king shall bestow on cultivators only such favour and remission as well tend to swell the treasury, and shall avoid such as deplete it. He shall regard with fatherly kindness those who have passed the period of remission of taxes. He shall offer facilities for cattle breeding and commerce, construct roads for traffic both by land and water, and set up market towns. He shall also construct reservoirs (sétu) filled with water either perennial or drawn from some other source. Whoever stays away from any kind of cooperative construction (sambhúya setubhandhát) shall send his servants and bullocks to carry on his work, shall have a share in the expenditure, but shall have no claim to the profit. The king shall exercise his right of ownership with regard to fishing in reservoirs or lakes, ferrying and trading in vegetables. He shall protect agriculture from the molestation of oppressive fines, free labourer, and taxes; herds of cattle from thieves, tigers, poisonous creatures and cattle-disease. He shall keep the herds of cattle from being destroyed by robbers. The king shall make provision for pasture grounds on uncultivable tracts.

- (i) *Advice to the Sage Kashyapa to the king* - Kashyapa has repeatedly stressed the need for a genuine support to farm activities by the king or ruler concerned. In the modern context, this would mean support from the central and state governments. The ruler's support is required in identifying land for agriculture, building water reservoirs, planting trees on the banks of water reservoirs, constructing canals and wells, water harvesting, making seed available, ensuring sustenance to people, giving donation of land and subsidies to weaker people, arranging markets, standardizing weights and measures, afforestation, locating mines producing metals such as iron, copper, and zinc (brass?) gold, and silver and collecting taxes. Kashyapa has thus strongly suggested a very major role for the ruler (governments today) in fully supporting various agricultural activities. He has emphasized that happiness all around can be felt only if there was food security. The king should appoint officers to search and acquire the best land who know the way to scrutinize the (quality of the land). Land selection is based on scientific examination of the soil. It is stated to be the king's duty to get the entire land examined by experts and identify land that is good for agriculture, is suitable for horticulture, should be of constructing permanent water reservoirs. The location could be villages, other parts of the country like towns or cities, mountains or the premises of forts and palaces. So long as good soil and supply of water were assured any location was considered good. Especially in the rainy season, keeping a vigil on hundreds of canals (or trenches), wells, and lakes will be beneficial. King should take care on prevention of diseases and alleviation of danger from fire, guarantees best welfare, all round nourishment, and protection for both the bipeds and the quadrupeds.

2.4.6 Kautilya's Arthashastra

I. Background on Arthashastra

Kautilya's Artha-Sastra (250 B.C.) is a detailed manual on statecraft and the science of classical times. Kautilya is also known as '*Chanakya*' and Vishnu gupta. Arthashastra deals with the science of politics, economics and the art of government in its widest sense—the maintenance of law and order as an efficient administrative machinery. Artha, literally means 'wealth', is one of four supreme aims prescribed by Hindu tradition. In accordance with this, Kautilya's Arthashastra maintains that the state or

government of a country has a vital role to play in maintaining the material status of both the nation and its people.

II. Features of Villages

Villages consisting each of not less than a hundred families and of not more than five-hundred families of agricultural people of súdra caste, with boundaries extending as far as a krósa (2250 yds.) or two, and capable of protecting each other shall be formed. Boundaries shall be denoted by a river, a mountain, forests, bulbous plants, caves, artificial buildings, or by trees such as silk cotton tree, *Acacia suma*, and kshíravriksha (milky trees). There shall be set up a stháníya (a fortress of that name) in the centre of eight-hundred villages, a drónamukha in the centre of four-hundred villages, a khárvátika in the centre of two-hundred villages and sangrahana in the midst of a collection of ten villages.

III. Agriculture

The superintendent of agriculture should possess the knowledge of the science of agriculture. Seeds of grains, flowers, fruits, vegetables, bulbous roots, roots, fibre-producing plants, and cotton may be collected in time. Sow the seeds on lands ploughed often and satisfactorily. Ploughs (karshanayantra) and other necessary instruments or bullocks are made available with the assistance of blacksmiths, carpenters, borers (medaka), rope makers, as well as those who catch snakes, and similar persons. Any loss due to the above persons shall be punished with a fine equal to the loss.

- (i) **Rainfall** - The quantity of rain that falls in the country of jángala is 16 dronas; half as much more in moist countries (*anúpánám*); as to the countries which are fit for agriculture (*désavápánam*);— 13½ dronas in the country of asmakas; 23 dronas in avantí; and an immense quantity in western countries (aparántánám), the borders of the Himalayas, and the countries where water channels are made use of in agriculture. A forecast of such rainfall can be made by observing the position, motion, and pregnancy (garbhádána) of the Jupiter (Brihaspati), the rise and set and motion of the Venus, and the natural or unnatural aspect of the sun. From the sun, the sprouting of the seeds can be inferred; from (the position of) the Jupiter, the formation of grains (stambakarita) can be inferred; and from the movements of the Venus, rainfall can be inferred. When one-third of the requisite quantity of rain falls both during the commencement and closing months of the rainy season and two-thirds in the middle, then the rainfall is considered as very even. If rain falls three times free from wind and unmingled with sunshine, ploughing is possible. Hence sow the seeds depending on the rainfall.

(ii) **Seasons**

- Two months make one ritu (season)
- Srávana and Proshthapada make the rainy season (Varshá)
- Asvayuja and Káarthíka make the autumn (Sarad)
- Márgasírsha and Phausha make the winter (Hemanta)
- Mággha and Phalguna make the dewy season (Sisira)
- Chaitra and Vaisákha make the spring (Vasanta)
- Jyeshthámúlfya and Ashádha make the summer (Grishma)

- (iii) **Division of land** - Lands on the banks of rivers, etc., are suitable for growing vallíphala (pumpkin, gourd and the like); lands that are frequently over flown by water (paríváhánta) for long pepper, grapes, and sugarcane; the vicinity of wells for vegetables and roots; low grounds (hariníparyantáh) for green crops; and marginal furrows between any two rows of crops are suitable for the plantation of fragrant plants, medicinal herbs, cuscus roots and lac. Medicinal

herbs suited to grow in marshy grounds can also be grown in pots. A forest provided with only one entrance rendered inaccessible by the construction of ditches all round, with plantations of delicious fruit trees, bushes, bowers, and thorn less trees, with an expansive lake of water full of harmless animals, and with tigers (vyála), beasts of prey (márgáyuka), male and female elephants, young elephants, and bisons—all deprived of their claws and teeth—shall be formed for the king's sports. On the extreme limit of the country or in any other suitable locality, another game-forest with game-beasts; open to all, shall also be made. In view of procuring all kinds of forest-produce described elsewhere, one or several forests shall be especially reserved. Manufactories to prepare commodities from forest produce shall also be set up. Wild tracts shall be separated from timber-forests. In the extreme limit of the country, elephant forests, separated from wild tracts, shall be formed.

- (iv) **Seeds and sowing** - Sáli (a kind of rice), vríhi (rice), kodo millet (*Paspalum scrobiculatum*), tila (sesamum), common millet (panic seeds), and varagu (*Phaseolus trilobus*) are to be sown at the commencement (púrvávápah) of the rainy season. Black gram (*Phaseolus mungo*) and green gram (*Phaseolus radiata*) are to be sown in the middle of the season. Kusumbha (safflower), masúra (*Ervum hirsutum*), horse gram (*Dolichos uniflorus*), yava (barley), godhúma (wheat), kaláya (leguminous seeds), linseed, and mustard are to be sown last or seeds may be sown according to the changes of the season.
- (v) **Choice of crops** - The farmer shall grow wet crops (kedára), winter crops (haimana), or summer crops (graishmika) according to the supply of workmen and water. Rice crop is the best to grow vegetables are of intermediate nature; and sugarcane is the worst and very difficult to grow as it require much care and expenditure.
- (vi) **Seed treatment** - The seeds of grains are to be exposed to mist and heat for seven nights; the seeds of kosi are treated similarly for three nights; the setts of sugarcane are plastered at the cut end with the mixture of honey, clarified butter, the fat of hogs, and cow dung; the seeds of bulbous roots with honey and clarified butter; cotton seeds with cow-dung; and water pits at the root of trees are to be burnt and manured with the bones and dung of cows on proper occasions. The sprouts of seeds, when grown, are to be manured with a fresh haul of minute fishes and irrigated with the milk of snuhi (*Euphorbia antiquorum*). Where there is the smoke caused by burning the essence of cotton seeds and the slough of a snake, there snakes will not stay. Always while sowing seeds, a handful of seeds bathed in water with a piece of gold shall be sown first and the following mantra recited:
- “Prajápatye Kasyapáya déváyá namah.
 - Sadá Sítá medhyatám déví b́jéshu cha
 - dhanéshu cha. Chandaváta hé.”
- “Salutation to God Prajapati Kasyapa. Agriculture may always flourish and the Goddess (may reside) in seeds and wealth. Channdavata he.”
- (vii) **Harvest** - Grains and other crops shall be collected as often as they are harvested. No wise man shall leave anything in the fields, or even chaff. Crops, when reaped, shall be heaped up in high piles or in the form of turrets. The piles of crops shall not be kept close, nor shall their tops be small or low. The threshing floors of different fields shall be situated close to each other.
- (viii) **Post harvest technology** - Clarified butter, oil, serum of flesh, and pith or sap (of plants, etc.), are termed oils (sneha). Decoction (phánita), jaggary granulated sugar, and sugar-candy is termed kshára. The honey of the bee as well as the juice extracted from grapes are called madhu. Mixture made by combining any one of the substances, such as the juice of sugar-cane, jaggary

and honey, the juice of grapes, the essence of the fruits of jambu (*Eugenia jambolana*) and of jaka tree—with the essence of meshasringa (a kind of plant) and long pepper, with or without the addition of the essence of chirbhita (a kind of gourd), cucumber, sugar-cane, mango-fruit and the fruit of myrobalam, the mixture being prepared so as to last for a month, or six months, or a year, constitute the group of astringents (sukta-varga). The fruits of those trees which bear acid fruits, those of karamarda (*Carissa carandas*), those of vidalámalka (myrobalam), those of matulanga (citron tree), those of kola (small jujuba), those of badara (*Flacourtia cataphracta*), those of sauvíra (big jujuba), and those of parushaka (*Grewia asiatica*) and the like come under the group of acid fruits. Long pepper, black pepper, ginger, cumin seed, kiratatikta (*Agathotes chirayta*), white mustard, coriander, choraka (a plant), damanaka (*Artemisia indica*), maruvaka (*Vangueria spinosa*), sigru (*Hyperanthera moringa*), and the like together with their roots (kánda) come under the group of pungent substances (tiktavarga). Dried fish, bulbous roots (kándamúla), fruits and vegetables form the group of edibles (sakavarga). Raw flour and boiled and forced rice will be as much as one and a half of the original quantity of the grains. Barley gruel as well as its flour baked will be twice the original quantity. Kodo millet (*Paspalam scrobiculatum*), varaka (*Phaseolus trilobus*) and common millet (*Panicum* sp) will increase three times the original quantity when cooked. Vríhi (rice) will increase four times when cooked. Sáli (a kind of rice) will increase five times when cooked. Grains will increase twice the original quantity when moistened; and two and a half times when soaked to sprouting condition. Grains fried will increase by one-fifth the original quantity; leguminous seeds (kaláya), when fried, will increase twice the original; likewise rice when fried.

Oil extracted from atasi (linseed) will be one-sixth (of the quantity of the seed); that extracted from the seeds, nimba (*Azadirachta indica*) and Kapittha (*Feronia elephantum*) will be one-fifth; and that extracted from tila (sesame), kusumba (safflower), madhúka (*Bassia latifolia*), and ingudi (*Terminalia catappa*) will be one-fourth. Five palas of kárpása (cotton) and of kshauma (flax) will yield one pala of threads.

- (ix) **Storehouse** - Grains are heaped up on the floor; jaggary (kshára) is bound round in grass-rope (múta); oils are kept in earthenware or wooden vessels; and salt is heaped up on the surface of the ground. Of the store, thus, collected, half shall be kept in reserve to ward off the calamities of the people and only the other half shall be used. Old collection shall be replaced by new supply.
- (x) **Agricultural workers** - Workmen in the fields shall always have water but no fire. Watchmen, slaves and labourers shall be paid a pana-and-a-quarter per mensem in proportion to the amount of work done by them. Artisans shall be provided with wages and provision in proportion to the amount of work done by them.
- (xi) **Food requirements** - One prastha of rice, pure and unsplit, one-fourth prastha of súpa, and clarified butter or oil equal to one-fourth part of (súpa) will suffice to form one meal of an Arya. One-sixth prastha of súpa for a man; and half the above quantity of oil will form one meal for low castes (avara). The same rations less by one-fourth the above quantities will form one meal for a woman; and half the above rations for children. Bran and flour (kánika) may be given to slaves, labourers, and cooks. The surplus of the above may be given to those who prepare cooked rice, and rice-cakes. For dressing twenty palas of flesh, half a kutumba of oil, one pala of salt, one pala of sugar (kshára), two dharanas of pungent substances (katuka, spices), and half a prastha of curd (will be necessary). For dressing greater quantities of flesh, the same ingredients can be proportionally increased. For cooking sákas (dried fish and vegetables), the

above substances are to be added one and a half times as much. For dressing dried fish, the above ingredients are to be added twice as much.

Rice prepared in such a way that five dróna of sáli yield ten ádhakas of rice will be fit to be the food of young elephants; eleven ádhakas from five drónas for elephants of bad temper (vyála); ten ádhakas from the same quantity for elephants trained for riding; nine ádhakas from the same quantity for elephants used in war; eight ádhakas from the same for infantry; eleven ádhakas from the same for chiefs of the army; six ádhakas from the same for queens and princes and five ádhakas from the same quantity for kings.

(xii) **Taxation** - Fields that are left unsown (vápátriktam, *i.e.*, owing to the inadequacy of hands) may be brought under cultivation by employing those who cultivate for half the share in the produce (ardhasítiká); or those who live by their own physical exertion may cultivate such fields for 1/4 or 1/5th of the produce grown; or they may pay (to the king) as much as they can without entailing any hardship upon themselves, with the exception of their own private lands that are difficult to cultivate. Those who cultivate irrigating by manual labourer shall pay 1/5th of the produce as water-rate; by carrying water on shoulders 1/4th of the produce; by water-lifts, 1/3rd of the produce; and by raising water from rivers, lakes, tanks, and wells, 1/3rd or 1/4th of the produce.

(xiii) **Commodity trade** - The Superintendent of Commerce shall ascertain demand or absence of demand for, and rise or fall in the price of, various kinds of merchandise which may be the products either of land or of water and which may have been brought in either by land or by water path. He shall also ascertain the time suitable for their distribution, centralization, purchase, and sale. Sale proceeds of grains, grains purchased and the collection of interest in kind or grain debts are termed commerce. Profitable exchange of grains for grains is termed barter (parivarthana). Grains borrowed with promise to repay the same is termed ápamityaka. Pounding (rice, etc.), dividing (pulses, etc.), frying (corns and beans), manufacture of beverages (suktakarma), manufacture of flour by employing those persons who live upon such works, extracting oil by employing shepherds and oil-makers, and manufacture of sugar from the juice of sugar-cane are termed simhanika.

The superintendent shall also personally supervise the increase or diminution sustained in grains when they are pounded (kshunna), or frayed (ghrishta), or reduced to flour (pishta), or fried (bhrashta), or dried after soaking in water.

(xiv) **Forest produce** - The Superintendent of Forest Produce shall collect timber and other products of forests by employing those who guard productive forests. He shall not only start productive works in forests, but also fix adequate fines and compensations to be levied from those who cause any damage to productive forests except in calamities.

IV. Animal Husbandry

A herd of 100 heads of asses and mules shall contain 5 male animals; that of goats and sheep ten; and a herd of ten heads of either cows or buffaloes shall contain four male animals. Herds are maintained for wages, a fixed amount of dairy produce, 1/10th of the dairy produce, etc. 'Class of herds-cattle is classified as calves, steers, tameable ones, draught oxen, bulls that are to be trained to yoke, bulls kept for crossing cows, cattle that are fit only for the supply of flesh, buffaloes and draught buffaloes; female calves, female steer, heifer, pregnant cows, milch cattle, barren cattle—either cows or buffaloes. Cowherds shall apply remedies to calves or aged cows or cows suffering from diseases. Cows and cattle shall graze the herds in forests, which are severally allotted as pasture grounds for various. Cowherds

shall allow their cattle to enter into such rivers or lakes as are of equal depth. The cowherds may sell either fresh flesh or dried flesh.

The cowherds shall milk the cows both the times (morning and evening) during the rainy, autumnal, and the first part of winter (hemanta) seasons and only once (*i.e.*, only in the morning during the latter part of winter and the whole of the spring and summer seasons). The cowherd who milks a cow a second time during these seasons shall have his thumb cut off. If he allows the time of milking to lapse, he shall forfeit the profit thereof (*i.e.*, the milk). The cowherds shall give buttermilk as drink to dogs and hogs, and reserve a little (buttermilk) in a bronze vessel to prepare their own dish: they may also make use of coagulated milk or cheese (kíláta) to render their oilcakes relishing (ghánapinyáka-kledartha). He who sells his cow (from among the herds) shall pay (to the king) $\frac{1}{4}$ th rúpa (value of the cow). One drona of a cow's milk will, when churned, yield one prastha of butter; the same quantity of a buffalo's milk will yield $\frac{1}{7}$ th prastha more; and the same quantity of milk of goats and sheep will produce $\frac{1}{2}$ prastha more. According to the protective strength of the cowherds the capacity of the cattle to go far and wide to graze, cowherds shall take their cattle either far or near. Once in six months, sheep and other animals shall be shorn of their wool.

- (i) **Rations for livestock** - For bullocks, one drona of green gram or one drona of barley cooked with other things, as prescribed for horses, is the requisite quantity of food, besides the special and additional provision of one tula of oilcakes or ten ádhakas of bran; twice the above quantity for buffaloes; Half an ádhaka or one ádhaka of grain together with bran for a goat, a ram and a boar; one prastha of cooked rice for dogs; Half a prastha for a hamsa (goose), a krauncha (heron) and a peacock. For bulls which are provided with nose-rings, and which equal horses in speed and in carrying loads, half a bhára of meadow grass (yavasa), twice the above quantity of ordinary grass (trina), one tulá (100 palas) of oil cakes, 10 ádhakas of bran, 5 palas of salt (mukhalavanam), one kudumba of oil for rubbing over the nose (nasya), 1 prastha of drink (pána), one tulá of flesh, 1 ádhaka of curis, 1 drona of barley or of cooked green gram, 1 drona of milk; or half an ádhaka of surá (liquor), 1 prastha of oil or ghi (sneha) 10 palas of sugar or jaggary, 1 pala of the fruit of sringibera (ginger) may be substituted for milk (pratipána).

V. Remedies Against National Calamities

The king shall always protect the afflicted among his people as a father his sons from eight kinds of calamities *viz.*, fire, floods, pestilential diseases, famine, rats, tigers, serpents, and demons.

- (i) **Fire** - King and superintendents of villages shall protect from fire on ordinary days, but also on full-moon days.
- (ii) **Floods** - Villagers living on the banks of rivers shall be provided protection from floods during the rainy reason. They shall provide themselves with wooden planks, bamboos, and boats. On new and full-moon days shall rivers be worshipped. Experts in sacred magic and mysticism and persons learned in the Vedas, shall perform, incantations against rain. During drought shall Indra (sachínátha), the Ganges, mountains, and Mahákachchha be worshipped.
- (iii) **Pestilences** - Protection against epidemics with auspicious and purificatory ceremonials, milking the cows on cremation or burial grounds, burning the trunk of a corpse, and spending nights in devotion to gods, worship of family-gods shall also be observed.
- (iv) **Famines** - The king shall show favour to his people by providing them with seeds and provision during famine or the king with his subjects may emigrate to another kingdom with abundant harvest. He may cause his subjects to grow grains, vegetables, roots, and fruits wherever water is available.

- (v) **Rats** - Cats and mongooses may be let loose to control rats. On new and full-moon days rats may be worshipped.
- (vi) **Snakes** - Auspicious rites may perform from Atharvaveda. On new and full moon days, (snakes) may be worshipped.
- (vii) **Tigers** - Catch tigers by entrapping them in nets. The juice of madana and kodrava plants may be thrown in tiger living places to destroy tigers. On new and full moon days, mountains may be worshipped.
- (viii) **Demons** - Ceremonials shall be performed with the rituals of the Atharvaveda to ward off the danger from demons. Such ascetics as are experts in magical arts, and being endowed with supernatural powers, can ward off providential visitations, shall, therefore, be honoured by the king and made to live in his kingdom.

2.5 AGRICULTURE AND SANGAM LITERATURE OF TAMIL

2.5.1 Sangam and its History

'Sangam' is a Sanskrit word which means as 'association'. 'Sangam poets' is an association of poets. Tamil Sangam was a body of Tamil Scholars or poets, a literary academy, which was established by the Pandia Kings. Sangam was known as 'Avaiyam', Kudal or its variant 'Kuttu' before 700 A.D. In Purananuru, the expression of 'Kudal' was used. Kudal was also used to indicate the Madurai city.

Thirunavukarasar (Appar) in his 'Tewaram' had used the word, 'Sangam' while Thiruzhanasambandar used the word 'Togai' means a collection. This showed that the institution was known as 'Kudal' or 'Togai' during Sangam period itself. Literature/poems is said to have been compared by the members of that body of poets. A system of literary censorship was exercised in Tamil language during early days of their literary history, which is known as 'Avaiyam' and not 'Sangam'. There were three Tamil Sangam constituted one after another and were called

- First Sangam or Thalai Sangam;
- Middle Sangam or Idai Sangam and
- Last Sangam or Kadai Sangam.

These periods was comprised of about 1000 years from 500 B.C to 500 A.D. as the extreme limits. Dravida Sangam in Madurai around fourth and fifth century was not a Tamil Sangam.

2.5.2 Tamil Literature—A bird's View

The Sangam literature provides very valuable information on the social, economic and political life of the people living in deltaic Tamil Nadu. Sanga kaalam is considered to be the Golden Age of Tamil Literature. The Ancient Sangam Age around 1000 B.C to 200 B.C was considered as the era of Tholkappiar. Tholkappiam is the oldest Tamil book. 'Tolkappiyar' whose age is generally placed in the 5th century B.C. gives us a lot of information for tracing the heritage of the Tamils. The land was treated as five regions viz., mountains, forests, fields, coasts and deserts and the theme of love in five aspects viz., union, patience, sulking, wailing and separation. The poet dealing with a certain aspect of love restricted himself to a particular region, season, hour, flora and fauna. These literary conventions are explained in Tolkappiyam. The third Sangam period, the most notable is Tiruvalluvar's Tirukkural or Kural, which deals with philosophy and wise maxims. It is the *second* great work with 1330 couplets (133 topics each having 10 couplets). It has been translated into English and several other languages. The Late Sangam Age around 200 B.C. to 200 A.D. is considered as an era of Thiruvalluvar. The *third* outstanding work in old Tamil is Silappathikaram around 200 A.D. as the era of Ilango. During the

middle Sangam, the Pandia kings had the capital in Thenmadurai on the shores of the Indian Ocean, which was later, destroyed by sea deluge. Then the capital and Sangam were shifted to Kapatapuram on the east coast. The sea too engulfed Kapatapuram. Then the capital and Sangam was shifted to the Madurai, an inland city. Thus the present Madurai on the bank of river Vaigai became the third capital and the seat of Third Sangam of poets. There were references in Silappathigaram and in Kalithogai.

'The Dark Age or the Kalabhra Interoregnum period witnesses the growth of Buddhism and Jainism in the now shrunk Tamil country. The Kalabhra, of the Kannada soil, invasion during 250 A.D. alters the shape of Tamil literature and Tamil way of life. The post-Sangam period (200–600 A.D.) is notable for the composition of five great Tamil epics - Silappadikaram, Manimekalai, Jivaka-cintamani, Valaiyapati and Kundalakesi. In 400 A.D., Ten Idylls (Pattuppattu) and the Eight Anthologies (Ettutthohai) are classified into Akam or esoteric dealing with love and Puram or exoteric dealing with war. The literature of the third Sangam period mainly comprises of poems, which are arranged in eight anthologies called Ettuttokoi and ten idylls called Pattuppattu. Ettuttokoi consists of Narrinai, Kuruntogai, Ainkurunuru, Padirrupattu, Paripadal, Kalittogai, Ahanuru and Purananuru. Pattuppattu consists of Tirumurugarrupadai, Porunararrupadai, Cirupanarrupadai, Pattinappalai, Kurincippattu, Nedunalvadai, Maduraikkanci, Malaipadukadam, Mullaippattu and Perumpanarrupadai.

Bakthi or The Pallava Period - The suppression of the alien Kalabhra clan by Pandiyan Kadumkon by the end of the 6th century had helped a revival of the ancient orthodox religions of the land. Besides these, the Jain authors have produced five minor works—Yasodhara-kaviyam, Chulamani, Perunkathai, Nagakumara-kaviyamand, Nilakesi. Besides these, the Jain authors have produced five minor works—Yasodhara-kaviyam, Chulamani, Perunkathai, Nagakumara-kaviyam and Nilakesi. The Chola period or the Epic period: Kamba Ramayana in the 9th century A.D. Kamban, belonged to this period. He was the greatest of the court poets of Kulottunga Chola III (1178–1218 A.D.). He adapted Valmiki's Ramayana in Tamil in his Ramakatai or Kamba Ramayanam. Another noble off spring of this period is Periapuranam.

- (a) **The age of Tamils ed Epic** - Between 600 and 900 A.D., the Tamil literature came under the influence of Saiva and Vaisnava saints called Nayanmars and Alvars respectively. The Saiva saints first compiled their hymns into the Devaram. The hymns of the Saiva saints were later collected into twelve anthologies called Tirumurais. The Periya Puranam or Tirutondar Puranam, considered as the twelfth Tirumurai, was composed by Sekkizhar (12th century A.D.). The Vaishnavaita saint Nathamuni (824–924 A.D.) compiled the Vaishnava hymns into four books called Divya Prabandham or Nalayira Divya Prabandham. The other Alvar saints who contributed to the Tamil religious literature include Periyalivar, Poigaiavar, Bhutattalvar, Andal (the only woman saint among Alvars) and Nammalvar. Nammalvar's Tiruvaymozhi, the third book of Divya Prabandham, is said to be a quintessence of the Upanishads.
- (b) **Modern literature** - The modern period witnessed the impact of Islam and Christianity on Tamil literature. Mohammedians rule during the 13th and 14th century. Umaruppulavar (1605–1703 A.D.) was the earliest among the Muslim Tamil poets. He composed the Sirappuranam, which is a verse narrative on the life of Prophet Muhammad. Another work dealing with the Islamic faith was Muhaidin Puranam (1845 A.D.) by Mohammad Ibrahim. Constanzio Beschi (1680–1747 A.D.), who adopted the pseudonym of 'Viramamunivar', wrote a classic Tembavani, on the life of Jesus Christ. Paramartta Gurukathai written by Viramamunivar in the 18th century affords the earliest specimen in novel writing in Tamil. Subramanya Bharati (1882–1921 A.D.) was one of the greatest of Tamil litterateurs of the modern times. He is renowned for his patriotic and devotional songs and intense prose writings on contemporary social affairs. His 'Panchali Sabadam' is an epic poem based on a single episode of the Mahabharata.

2.5.2 Agriculture

Agriculture was the Principal occupation of Tamils. The Agriculturalists were called ‘Ulavar’ and their women the ‘Ulattiyar’ (Tolporul, 20). The classes of people owning land and the class of people actually tilling the land were ‘Vellalas’ the farmer known as the superior ‘Vellalas’ and the latter known as inferior ‘Vellalas’. Ulavar was also known as Valnar. Ulutunbar or Yerin. Purananuru calls Ulavar as Kalamar. The term Ulavar itself indicates the use of the plough and the term Vellalar denotes the propertiership of the soil. The cowherd community counted the cattle as wealth while among agriculturalists the number of plough was the standard of measurement of wealth. A poet in Karuntogai speaks of ‘Orerulavar’ a peasant with one ploughshare. Thiruvalluvar had highlighted the importance of Agriculture in PART-104, Thirukural. Agriculture is considered as an esteemed profession (Kural, Chap 104). Valluvar had described the desirable feature of a territory or country. A country should have good agriculturalists and learned and wealthy men. It must be free from hunger, disease, and enmity. A country should not be under the influence of famine. In whatever occupation others might be engaged they might be engaged, they must all depend finally on the farmer (Kural, 1031), even the ascetics will become helpless if presents do not till the lands (Kural, 1036). Agriculture is not as dignified as other professions; on the other hand, the agriculturalists are positively the support of whole world (Kural, 1032). Agriculturalists alone lead a truly useful life, the rest being only parasites and sycophants (Kural, 1033). According to Thiruvalluvar an agriculturalist must: (i) plough the land; (ii) manure it; (iii) transplant the seedlings; (iv) ensure an unfailing supply of channel water and (v) protect the cultivated farm from the stray cattle (Kural, 1038). He warns the farmer against lethargy, he bids him be active and never despond (Kural, 1040). The farmer is to guard against absentee-landlordism (Kural, 1039).

A. Farmers, the Founders of Civilization

Thiruvalluvar had high lightened the agriculture profession in PART 104 as follows: Behind the plough in the whole world and is the prime of all professions (Kural 1031). Tillers of the soil are the axle-pin of the revolving world because they sustain all others who have the plough and take to other occupations (Kural, 1032). Farmers only live by right that till the soil and raise their own food, rest are parasites, who live upon them (Kural, 1033). The state of green fields, waving in fullness with sheaves of corn, will surely bring many countries around them under the influence (Kural, 1034). Trade increases the wealth and glory of a country; but its real strength and stamina are to be looked for among the cultivators of the land. The farmers, who eat only the fruits of their own toil, will never beg, nor will they deny alms to a mendicant at their door (Kural, 1035). If the tillers of the soil withdraw their labour, even those who have renounced the world will lose their serenity and concentration of spirit (Kural, 1036). If the tillers of the soil withdraw their labour, the householders support to the ascetics will naturally be affected and lose their concentration (Kural, 42). If the ploughed soil is left to dry to a fourth of its bulk, there will be plenteous crop, without even a handful of manure being put in (Kural, 1037). Valluvar considers the preparation of the soil as the first and foremost step while effective aeration and purposeful nitrogenisation are incidental to it. Manuring is more important than ploughing, then, after proper weeding; plant protection is more important than water management. (Kural 1038). If the husband-man does not pay personal attention to his land like the neglected wife that field will turn its face away in loving anger. (Kural, 1039). The good earth will laugh derisively at those, who pleading poverty, sit idle and neglect their productive land.

B. Climate

Rain is respected as the axle for the world and basic need of the people (Nartrinai, 139). World cannot

exist in absence of the water (Natrinal 1: 6). Rain bearing clouds under shrouding darkness with lightning gives cool showers, the clouds that of a beating drum with short thick sticks and thunder again and again gives heavy rains (Kurunthogai 270). Thiruvalluvar had stressed the need and importance of rain not only for agriculture but also to the wealth and spiritual life of people in PART III of Thirukural. Valluvar praised the rain as follows: As the falling rain sustains the world, it must be deemed as the Amuta (the drink of immortal Gods) or the nectar of life (Kural, 11). From food come fourth begins, from rain food is produced. All food is produced because of rain, which itself is food again (Kural, 12). If rain fail, hunger will cause infinite misery to the world, even though it is surrounded by the wide oceans (Kural, 13). If there is diminution in the bounty of rain, the ploughmen will be forced into idleness (Kural, 14). Want of rain, spell ruin the prosperity, sufficiency of rain in farm, will lead to renewed prosperity. Even excess rain and cyclonic flood sometimes bring disaster (Kural, 15). If the clouds do not shed drops of rain, even blades of grass cannot shoot up (Kural, 16). If the clouds produced by the sea fail in their bounty, even the wealth of the seas will shrink (Kural, 17). The pearl formation would suffer due to the failure of rain in summer season. If rain failure occurs in October-November, coral conception would be affected. If rain fails, there will be neither festivals nor rituals for the Gods themselves (Kural, 18). If heavens will not give up of their bounty to give rain to this world, Alms to the needy and penance for the spiritual uplift cannot be sustained (Kural, 19). Even as life on earth cannot sustain without water, Virtue too depends ultimately on rain (Kural, 20).

C. Seasons

Seasons were broadly classified into Ilavenil–(Chitrai–Vaigasi); Mudhuvēnil–(Aani-Adi); Karkalam–(Avani-Puratassi); Kuuthgirkalam–(Ipachi-Karthigai); Munpanikalam–(Marghali-Thai) and Pinpanikalam –(Masi-Panguni). Vengai flowers bloom with loosened petals and the fallen petals beautify the river bed's black sand locks in the spring (Early summer) season (Kalithogai, 32). The agriculture of the delta fell into two divisions: a double crop and a single crop economy. The former consisted of growing a short crop of rice first, and a longer duration crop afterwards. The rice growing seasons of Tamil Nadu varies from region to region. The short crop in turn, consisted of two varieties—a four months variety called 'Kar' and a hundred days variety called 'Kuruvai'. The former was confined to the first reaches of the delta. Where the seedlings could be raised before the advent of the freshes and in reasonable anticipation of its certainty, and the latter was the more common variety. The second crop grown on double crop land was known as 'Thaladi', as distinguished from 'Mudladi' which was the first crop. The major crop economy, growing five months crop called 'Samba'. The first crop season was from June to October. The second crop October to February. The single crop season was spread over from June to January.

D. Landscapes Classification of Tamil Nadu in Tholkappiam

Tamil Nadu is bounded by Thirupathi in the North and Cape Comorin (Kumari) on the south and seas in the east and west (Kakaipadiniyar). Landscapes in corresponding to a flower, time of day, and stage of love-relationship in Table 2.3.

Tholkappiar further classified the land as Vanpulam (Kurinchi, mullai) and Menpulam (Marutham, Neithal). Since Mullai land is located by the side or next to Kurinchi land, it is known as 'Puravu'. The cultivation of fruit trees and crops for cattle was undertaken in Mullai lands. Tholkappiar referred the Mullai land as 'Kadurai Ulagam' since the trees occur in predominant areas. It has grasslands on in larger areas. Growing sheep and weaving wool clothes was yet another profession. Tenai and paddy was cultivated in Kurinji. 'Palai' is really a non descript mixture or medley of Mullai and Kurinji tracts rather than a mere sandy tract (Silapathigaram). It must be remembered that there is no desert in Tamil

Nadu. Marudam land is fit for agricultural operations. In Marutham, rice in the staple food. Cattle were their-favorite beasts; Vanji, Kandri and Marudam were Chief trees of the Marudam lands. In fact, the land Marudam was delivered its name from the tree Marudam. Their occupation was agriculture and the lotus was their sacred flower (Tor Porul, 18). There is no separate Palai land in Tamil Nadu. If rain fails, the Mullai and Kurinchi lands turns into Palai land (Silapathigaram). Thiruvalluvar mentions two chief characteristics of an ideal state/country viz., (i) *talla vilaiyal*: fertility of the land ensuring perennial supply of food to the population (Kural, 41), and (ii) *Vallaran*: Suitability of the terrain for purposes of defense against foreign attacks (Kural, 40).

Table 2.2. Features of Landscapes in Ancient Tamil Nadu

<i>Land-scapes</i>	<i>Mullai</i>	<i>Kurinji, Punam</i>	<i>Marudham, Vayal, Kalani, Palanam</i>	<i>Neithal, (Adaikarai-Nattrinai)</i>	<i>Palai</i>
Land type	Forest and pasture (shrubbery)	Mountain, hilly tract	Agricultural areas; plains and valleys	Coastal areas, marine tract	Barrenland (desert and sandy tract, vegetation sparse)
Soil	Red soil	Red and black soils with stones and pebbles	Alluvial	Sandy soil, saline soil	Salt affected soil
Crop	Tenai, varagu, cotton	Cotton, Rice var Kulanel, Thoppinel, Thorainel	Sugarcane, Rice var. Vennel; Mudandainel	————	————
Flower	Mullai (white jasmine)	Kurinchi (blooms once every twelve years)	Marutam	Water lily	Paalai
Stage of love	Heroine expresses patient waiting over separation	Union of lovers	Lovers' quarrels, wife's irritability (husband accused of visiting a courtesan)	Heroine expresses grief over separation	Longest separation; dangerous journey by the hero
Season of year	Cloudy (Aug-Oct)	Cool and moist (Nov-Dec)	No specific season	No specific season	Hot and dry (April-Sept)
Time of day	Evening	Midnight	Shortly before sunrise	Sunset	Midday
Livestock/ Fish	Goats, cattle	————	Buffaloes, penning with goats or cattle	Fish culture	Sheep, goats
God	Vishnu, Mayan	Murugan, Subramanian	Indra, the rain god	Varuna	Durga, Korravai

E. Agricultural Implements

Buffaloes were used for ploughing with a wooden plough. Deep ploughing was considered superior to shallow ploughing. A labour saving tool called parambu was used for levelling paddy fields. Tools such as amiry, keilar, and yettam were used to lift water from wells, tanks, and rivers. Tools called thattai and kavan were used for scaring birds in millet fields. Traps were used to catch wild boars in millet fields.

F. Land Preparation

Thiruvalluvar gives a few ideas about agricultural operations. If an agriculturalist would allow the ploughed land to dry up so that one todi (one palam) of dust dries down to one kashi (1/4 palam) *i.e.*, if it is reduced to one fourth (1/4) of the original quantity, there will be no need to put into the land even one handful of eru, *i.e.*, manure (Kural, 1037). Ploughing was carried out many times instead of single time (Ahananuru, 26:24-25). Agriculture can be practiced easily when the cultivator has his own ploughs, Iniyavainarpathu, 3:3). Ploughing one time was referred as Orusal ulavu; twice as Irusal ulavu and many times as Chensal ulavu. Plough the land deeper than wider. Cattle were used for ploughing. Cyperus weeds and crab cavities were destroyed during land preparation and levelled in wetlands (Perumpanattrupadai). Crops had been raised in beds and channels (Nanmanikaddigai, 16).

G. Crops and Varieties

Ancient Tamils cultivated paddy, black gram, horse gram, varagu, tenai, sesame, sugarcane, banana, coconut, palmgrab, bamboo grasses, jack fruit, tamarind and mango. Varagu was cultivated in Mullai lands (Purananuru, 120). Tenai and field bean (Mochai) were cultivated as mixed crop in Kurinchi lands (Kurunthogai, 72.240). Cotton and Tenai were cultivated as mixed crops (Kurunthogai, 72). Rice varieties such as Chennel, Vennel, Salinel, Mudandainel, Ivananel, Kulanel, Thoppinel, Pudunel, Varnel, Aviananel, Torainel were cultivated (Purananuru, Pattinapalai, Kurunthogai, 277). Mungil el or Mungil arisi obtained from bamboo. It was taken as food at the time of king Pari (Purananuru, 109). Red gram, Black gram was cultivated in Marutham lands (Aaga nanuru, 339: Natrinai 28, Purananuru, 297). Sugarcane was cultivated with check basin Method at the foot hills (Kurunthogai, 262). Sugarcane var. Kalik karumbu was cultivated in Thagadur region during the king Adiyaman period (Purananuru, 99). Banana was cultivated. Its terminal loft's medicinal properties was mentioned in Kurunthogai, 308. Rice, sugarcane, coconut, plantains, areca palm, turmeric, mango, palmyra, sembu (*Colocasia antiquolam*) and ginger were grown in Cauvery river valley. A 'Veli' of land produced a round thousands kalams of paddy. Farmer enjoys on seeing the first freshes and hearing the sound of Cauvery flow and of the eddying water scouring the bunds (Silappadikaram).

H. Seeds and Sowing

Seed was selected from those earheads that first matured. The selected seed was stored for sowing only and never used as food grain. It was believed that such a diversion would destroy the family. Sowing tenai seeds without ploughing was also practiced. Cyperus weeds were removed through feeding with pigs and then in such lands seeds were sown without ploughing (Purananuru, 168-6). Seeds were sown with adequate spacing (Narrinai). Seed germination happens with adequate moisture (Nanmanikadigai, 67).

I. Cropping Systems

Crop rotation was practiced by raising black gram (urd) after rice. They also practiced mixed cropping; *e.g.*, foxtail millet with lablab or cotton. Ginger and turmeric were grown as intercrops in coconut and jack fruit plantations. Rice fallow cultivation with other crops such as pulses had been reported in 'Ingurunuru'. Cultivation of sugarcane was reported in 'Pathittrupattu'. Mixed cropping of cotton and tenai were also practiced. Pepper was grown as mixed crop in mango plantation (Inthinai, 8:1-2).

J. Weed Management

Weeds were removed from the fields (Madurai kanchi). Tools were used for weed control (Ahananuru). Weeds hamper the growth of crops (Nanmanikadigai).

K. Soil Fertility

Thiruvalluvar stated that fertile land alone is entitled to be called territory (Nadu) which yield wealth unsought for (Kural, 739). The fertility of the land especially in Chola Kingdom finds proud mention in contemporary literature. Organic manures were applied in ploughed lands (Narrinai). Avur Mulankilar in a short poem addressed to Killivalavan says, “The land is so fertile that a tiny piece there of, where a she-elephant might rest, can produce enough food to nourish seven bull elephants (Purananur, 40). The fertility of the land even in hilly areas like the Palakunrakottam (land between Tirupathi and Tiruvannamalai) was such that the sesame crop was so healthy and full grown that a handful could contain no more than seven grains of sesame (Malaipadu, 102 to 106). Even without ploughing, merely sowing deep in turned sod made mustard grown in great quantities (Malaipadu, 122 to 123). In a fairly fertile farm, a veli of land produced a full thousand kalams of paddy (Porunnar, 246 to 248). The silt carried by the flood water was a major source of fertilization, and the greater the volume of water, the greater the valuable silt deposit. Some of the more favourably situated fields were known as “Erikkattu” meaning tank reservoir. This was an ingenious system of “field insurance” against the risk of floods.

L. Irrigation Management

Water quality depends on land type (Nanmanikadigai, 80). Moisture stressed crops grow well on receipt of rains (Iniyavainarpathu15:2); construction of ponds for others use is essential (Iniyavainarpathu1, 23:1).

- (i) **Art of well divining** - The Cankam art works speak of the art of well-divining practice of the Tamils to wells on the highways for the weary travellers (Naririnai, 240; Purananuru, 306). The didactic work Tirikatukam (14) refers to the virtuous act of digging ‘drinking water wells’ bounteously. Tivakaram and Kayatara Nikantu refer to those well-versed in well-divining as ‘ulliyar’ and calliyar’ respectively. Although ‘Kual, Acumpu, Kupam, Kuli, Puval, Keni, Turavu are used synonymously to denote well, cankam classic speak of kual only. Patirrupattu (51) and Ainkurunuru (203) revealed that the wells of those days, generally, were of shallow depth only. According to two manuscripts, rocky lands were classed as ‘Kurinchi’; the land with coarse sand, ‘Neytal’; the land abounding in scattered minor rocks, ‘Mullai’; muddy land, ‘Marutam’ and the unused tract ‘Palai’, of which the Neytal tract was supposed to have moisture. The depths of the water source in different lands differed from the surface land. In Kurinchi springs will be found at a depth of 33 cans, in Palai 30 cans, in Mullai 36 cans, in Neytal 35 cans and in Marutam 22 cans. The soil fit for the growth of banyan tree, tamarind, mango and so on might have water springs at different depths. The places where white rats, scorpion, the double-tongued lizard, toad and so on inhabit might have water sources. Another manuscript talks about the brownishness of Mullai water, whiteness of Palai water, Kurinchi’s blackish water, Marutam’s potable water and saltish water of Neytal. A well, which had disappeared due to human or natural calamities, can be traced on the basis of certain varieties of grass getting withered in winter and flourishing in summer season. In such places, there would be a swarm of flies and ants; also anthills appearing in places where certain grassy plants grow and such trees as ‘Vanci’ and ‘Nocci’ flourishing during the hot summer season, would be sure indications of the existence of wells-now disappeared in such places.
- (ii) **Major irrigation system of ancient Tamil Nadu** - In Purananur (18), Kudapula - Vianar says that a large irrigation system has relieved the peasants from dependence on the monsoon. The Pallavas, whose capital was in Tondaimandalam, constructed several irrigation tanks, and practically all of them are functioning to this day. The Cholas, besides constructing tanks, tamed

the Cauvery river, an achievement of which any monarch and his people may be proud. The Pandyan Country was divided between fringe irrigation alongside of the rivers and the utilization of tanks. The two major rivers of Tamil Nadu are the Cauvery and the Tamiraparani. The Vaigai has at no time been a source of great importance. The Cauvery river rises in the western ghats near Coorg and after a course of nearly 500 miles, enters the Bay of Bengal, draining an area of about 31,000 square miles in route. In the Cholamandala Satakam there is mention of the Kallanai or the Grand Anicut being constructed. Karikalan is said to have employed several thousands of Ceylonese for this purpose. According to the "Mahavamsa", one hears of an aged woman complaining to Gajabahu that amongst the twelve thousand persons taken away by Karikalan for making the embankment of the Cauvery was her only son. According the Pattinathupalai, Karikalan was known as "Kaaverinaadan" due to his taming the violent river. His raising of the flood banks of the Cauvery was mentioned in the Malepadu plates of Punayakumara, a Telegu Choda king of the seventh or eighth century. A list of some of the major irrigation works are furnished in Table 2.3.

Table 2.3. Major Irrigation Works in Ancient Tamil Nadu

<i>Name of the work</i>	<i>King to whom attributed</i>	<i>Date</i>
Grand Anicut	Karikalan Chola	1st Century
Thirayan Eri	Thirayan	6th Century
Mahendra Tataka	Mahendravarman I	7th Century
Parameswar Tataka	Parmaeswara Varman	7th Century
Vairammega Tataka	Vairamega Pallava	8th Century
Marpidigu Eri	Vairamega Pallava	8th Century
Valian Eri	Dandivarman	8th Century
Kaveripakkam tank	Nandivarman	8th Century
Kilavan Ari	Nedumaran Srivallabha	8th Century
Maraneri	Maran	8th Century
Kudimallam Tank	Tandikramavarman	8th Century
Maruthadu	Vijayanripatunga	9th Century
Dharmapuri Tank	Mahendra Pallava	9th Century
Ukkal Tank	Kampavarman	9th Century
Chola Varuthi	Parantaka I	10th Century
Chodiumbakan Tank	Parantaka I	10th Century
Nangavaram Tank	Arunjaya	10th Century
Veeranam Eri	Veeranarayana	10th Century
Uyyakondan Channel	Raja Raja I	10th Century
Bahur Tank	Raja Raja I	10th Century
Periya Vaikal	Raja Raja I	10th Century
Chola Ganga	Rajendra	10th Century
Parakara Kallanai	Jayadeven Srivallabha	11th Century

The anaicuts on the Tamiraparani are noticed separately. Seven anaicuts were constructed across the Tamiraparani. The exact dates when they were constructed are not known. The usual local legends have grown around each of them. That they are ancient, however is evident. They are in order namely, Kodaimelalagiyan, Nadiyunni, Kannadiyan, Ariyanayakapuram, Palavur, Suttamalli, and Marudur.

- (iii) **Tank systems** - The Tamils constructed two types of tanks; large tanks, such as those referred to in the early part of this paper, and innumerable smaller ones scattered all over the undulating interior of the Tamil country. Both kinds of tanks were largely looked after by the people themselves. The inscriptions in some of the tanks make mention of this responsibility. "The primary care of the village assemblies was to get the silt removed (Every year before the rains set in) from the tanks under their control in time for them to secure the proper depth needed to store the full supply for the next year. Often special endowments were created or the penury of village authorities. In some instances a cess called 'Eriayan' was collected from the villages for this purpose. The Cauvery system is very ancient is evident from Sangam literature. The Grand Anicut, constructed by Karikalan in the first century is still in effective use.

M. Plant Protection

Fencing had been laid out around the fields to protect from the animals. Fencing was done with bamboo (Kurunthogai); Karuvel (*Acacia* sp.-in Ahananuru).

N. Harvesting and Threshing

Harvesting was carried out in night time with beating drums to protect from the wild animals (Kunthogai, 375;3; Madurai kanchi, 259-260); (Malaipattu, 471). Rice crop was harvested using a tool 'Kuyam' (Narrinai, 195: 5-6). Rice was threshed using cattle and elephants (Malaipadukadam, Perunarutrupaadai). Garden land bean (Avarai) was cultivated in Tenai stubbles (Ingurunuru: 284:1-2); sowing of tenai and cotton in harvested tenai lands (Malaipadukadam, 122-123).

A tool called 'senyam' was used for harvesting rice. Threshing of rice was done by hand with the help of a buffalo (and in large holdings by elephants). Hand winnowing was done to remove chaff. One sixth of the produce was paid as tax to the king. Farm labourers were paid in kind. The land was immediately ploughed after harvest or water was allowed to stagnate to facilitate rooting of stubble. Operations requiring hard work such as ploughing were done by men while women attended to light work such as transplanting, weeding, bird scaring, harvesting and winnowing. In Kandapuram, it is mentioned that Valli, the daughter of a king, was sent for bird scaring in millet fields where Lord Muruga (son of Lord Shiva) courted her and married.

O. Marketing

Products were exchanged by weight. In Madurai (the headquarters of Sangam poets), there was a food grains bazaar where 18 kinds of cereals, millets, and pulses were sold. Each shop had a banner hoisted high so that it could be seen from a distance indicating the grains sold. Customs duty was collected on imports and exports.

Revenue from Agriculture: Tamil kings collected land tax, which was known as 'irai' or 'karai', tolls and custom duties. Revenue collection was known as 'ulgu' and 'sungam'. The duties paid by the king (King's share) were known as 'Kadamai', 'Paduvadu' or 'Padu'. 'Vari' was a generic term meaning income, *i.e.*, revenue. Extra demands or forced fits were called 'iravu' 'vari' refers to tax, 'Variam' refers to the tax collecting service and 'Variyar' referred to an officer collecting tax. One sixth (1/6) of

produce from land was paid as land revenue to the kings. King assigns tax-free lands to certain persons or institutions. Such lands were called 'Puravu' or 'iraiyili nilam'. Revenue relief was given due to unexpected poor harvests because of failure of rains. The poet Iraiyanar Ahapporul mentioned a long period (twelve years) of failure in the Pandia kingdom. On such occasions of extreme famine, the farmer lived consuming the seeds normally intended for sowing.

2.5.3 Astronomy

The path of the Sun being a fixed circle among the fixed stars is called ecliptic. The relative Sun moves along the ecliptic from West to East. To mark the movement of the sun, Moon and Planets, the ecliptic is divided into 27 equal parts called "Nakshatras" (fixed stars) and also 12 equal parts called 'Rashis' (Signs). The time taken by the Sun to complete one round along the ecliptic is a fixed period, called Sidereal Year. The Sidereal year, Calendar year or Julian Year is made up to 365.2568 days and the Tropical year made up to 365.2422 days. There was excess 0.0078-day *i.e.*, 3 days in 400 years. The Sidereal day is shorter than the apparent Solar Time by 4 minutes. The earth goes round the sun in 24 hours, but with reference to a Star, it goes round the sun within 23 hours and 56 minutes. Julius Caesar introduced the concept of leap year once in four years and was made equal to 365.25 days. Axis of rotation causes the appearance of the sun oscillating slowly north south wards and south-north wards. When the sun comes exactly above the equator twice a year one is called the beginning of Vasantha (spring) ruthu and the other, the beginning of Sharad (Autumn) ruthu. The Sun has another motion-North to South and South to North. It crosses the East-West line twice a year. It goes 23½ to South-East and 23 ½ North-East (Similarly of Western Zenith). But, the period between the two crossing of each point (From South to North and from North to South) is not always constant and the Sun does not cross the ecliptic at the same point. This is called Precession. In other words, the Period from one Vernal Equinox to another Vernal Equinox may be called the Tropical Year. The duration of the 'tropical year' is accounted on the basis of the movement of the Earth around the Sun. In order to cover all the seasons, its duration per year is 365.2422 days. The tropical calendar was spread to the different parts of the world by Sage Vasishtha and his brother sage Agastya. That is why we find Sun temples all over the world.

Distance to be covered in the southernly direction is known as Dakshinaayana (summer solstice). Dakshina + Ayana it means the southern + latitudinal distance to be traversed. When the sun is in the north, it is called, Dakshinaayana (summer solstice). Dakshinaayana (summer solstice) us of 6 months duration tropically and so too is Uttaraayana (winter solstice). When the rays change their directions and it will be found to do so either on June 21st or 22nd or December 21st or 22nd depending on whether it is Dakshiaayana (summer solstice) or Uttaraayana (winter solstice) respectively. Equinoctical points are those on the orbits of the earth on which equal days and nights will appear and this happens twice a year on June 21st or 22nd or December 21st or 22nd.

A. The Zodiac

Zodiac is the division of the heavens into twelve astrology signs, each comprising exactly one-twelfth of the heavenly circle or 30° and totalling 360°. The Zodiac is a circle of space surrounding the Earth. It may be imagined as a belt in the heavens about 15 degrees wide in which the planets travel. It is the Sun's apparent path that is called ecliptic. The zodiacal circle is divided into twelve parts, each part containing thirty degrees of space called the signs of the Zodiac. Thus a sign is one twelfth division of the zodiacal circle and is defined as containing 30 degrees of celestial longitude: 12 signs each measuring 30 degrees constitute the circle of the Zodiac or 360 degrees. In this circle the planets travel

each in its own orbit, one outlying beyond the other. The twelve signs of the Zodiac are Aries (Mesha), Taurus (Vrishabh), Gemini (Mithuna), Cancer (Kataka), Leo (Simha), Virgo (Kanya), Libra (Thula), Scorpio (Vrischika), Sagittarius (Dhanus), Capricorn (Makara), Aquarius (Kumbha) and Pisces (Meena). It is the twelve signs through which the planets travel or transit from west to east, going through one sign after another in their order from Aries to Pisces. Each sign possesses a specific influence. The planets also as they travel around the Zodiac exert an influence according to their separate nature and position in the Zodiac. Although according to modern Astrology there are twelve planets *viz.*, Sun, Moon, Mars, Mercury, Jupiter, Venus, Saturn, Rahu, Kethu, Uranus, Neptune and Pluto, Hindu Astrology recognizes only the first nine. Each sign of the Zodiac is owned by a planet that is termed as its 'ruler' of the sign. Sun and Moon rule one sign each *viz.*, Leo and Cancer respectively. Mars rules Aries and Scorpio, Mercury rules Gemini and Virgo, Jupiter rules Sagittarius and Pisces, Venus rules Taurus and Libra and Saturn rules Capricorn and Aquarius. Sun is the king of the solar kingdom. He is also called the 'Father of Stars'. Westerners call the Sun Apollo. The sun takes exactly one year to go round the ecliptic or zodiac.

Quadruplicity: Each sign belongs to one of four groups of signs based on their elemental tendencies to be either fiery, earthy, airy, or watery in temperament.

<i>Elements</i>	<i>Rasi/Zodiac/Signs</i>
Fire	Aries, Leo, Sagittarius
Earth	Taurus, Virgo, Capricorn
Air	Gemini, Libra, Aquarius
Water	Cancer, Scorpio, Pisces

Note: Capricorn is half-watery and half-earthly

B. Seasons and Equinoxes

Sun, the latter's rays fall equally only on two days in a year *i.e.*, the day and nights are equal on two days a year when the Sun enters the Equator. These two days are March 21st and September 21st. One is called autumnal equinox and the other is called vernal equinox. In Sanskrit autumnal is known as the

<i>Seasons</i>	<i>Parts</i>	<i>Period</i>
Vansantha Rithu	Madhu	March 21st to April 21st
	Madhava	April 21st to May 21st
Greehma Ruthu	Sukra	May 21st to June 21st
	Suchi	June 21st to July 21st
Varsha Ruthu	Nabhas	July 21st to August 21st
	Nabhasya	August 21st to September 21st
Shard Ruthu	Lisa	September 21st to October 21st
	Urija	October 21st to November 21st
Hemantha Ruthu	Sahas	November 21st to December 21st
	Sahasya	December 21st to January 21st
Sisira Ruthu	Tapas	January 21st to February 21st
	Tapasya	February 21st to March 21st

first day of Sarad Ruthu and the vernal equinox is known as first day of Vasantha Ruthu. These points are also known as equinoctial points or Vishu bindus. There are basically six seasons. Each of the above six seasons has been divided into two parts.

The Moon which is a natural satellite of the Earth moves around the Earth once is about 28 days, *i.e.*, it takes about 28 days to come to the same star, after going around the earth. This is called the Sidereal Movement of the Moon. There is another way of recognizing the movement of the Moon around the Earth and that is with respect to the Sun. On Amavaya (New Moon) Day Poornima (Full Moon) Day, the Sun, the Moon, the Earth are on the same line longitudinally. From one Amavasya (New Moon) to another Amavasya (New Moon) it takes about 30 days. Each of these divisions (of 30) is called a Thithi (phase). This division of months is called Luni-solar Months. This is recognized in the Panchanga (Calendar) as Prathma (1st day), Dwithiya (2nd day) etc. Sukla prathama (1st day of Bright half) or Krishna Prathama etc. (1st day of Dark half) depending on the bright or dark fortnight.

Sukala Paksham/Krishna Paksham

<i>S.No.</i>	<i>Sukala paksham thithi</i>	<i>S.No.</i>	<i>Krishna paksham thithi</i>
1	Prathama	1	Prathama
2	Dwithiya	2	Dwithiya
3	Thrityiya	3	Thrityiya
4	Chaturthi	4	Chaturthi
5	Panchami	5	Panchami
6	Sashti	6	Sashti
7	Sapthami	7	Sapthami
8	Ashtami	8	Ashtami
9	Navami	9	Navami
10	Dasami	10	Dasami
11	Ekaadasi	11	Ekaadasi
12	Dwaadasi	12	Dwaadasi
13	Thryodasi	13	Thryodasi
14	Chaturidasi	14	Chaturidasi
15	Poornima or full moon	15	Amavasya or new moon

C. Planetary Movement

There are five planets moving around the sun. They are Mercury, Venus, Mars, Jupiter and Saturn. By the time mercury, goes round the sun, approximately 88 days. Would have elapsed (4 rounds a year); by the time Venus moves round the sun, it will be 224 days; for mars it is 686 days, for Jupiter 4332 days; and for Saturn 10,759 days.

D. Ancient Systems of Time

Our ancient calculated time is as follows : one day = 60 Naligais; 1 Naligai = 60 vikalas. Therefore a day = 60 × 60 × 60 × vikalas = 2,16,000. The Rig Veda contains 4,32,000 units of sounds therefore 1 vikala = 2 units of sound.

E. Ancient Hindu Calendar

1. **Samavatsara-** Samavatsara corresponds to a year. Vikrama Smavat starting from 57 B.C. and Shalivahana Saka starting from 79 A.D. were the two systems used in ancient India. The references in Krishi Parashara are to Saka. There is a cycle of sixty years called Jupiter cycle and all the sixty years have individual names and characteristics. Parashara's reference to Saka year is currently 1920 (*i.e.*, 1998 A.D.). In the Panchang or Almanac system in whole of India, rainfall forecasting/prediction based on ruling planet and minister planet is worked from a base year Salivahan Saka from 1920 (*i.e.*, 1998 A.D.). Datye's Marathi Panchang using the base year Salivahan Saka (Shaka) from 1919 or 1997 A.D. refers to adhaka as the measure of water in land area of 240 kroshas in width (768 km) and 400 kroshas (1280 km) in length.
2. **Seasons** - Six seasons in Rigveda: Grishma (Jyestha-Aashadha or May-June), Varsha (Sharavana-Bharapada or July-August), Hemant (Margashirsha-Pausha or September-October), Sharad (Ashwin-Kartika or November-December), Shishir (Magha-Phalguna or January-February) and Vasanta (Chaitra-Vaishakha or March-April).
3. **Months (Masa) of a year** - Pausha (January), Magha (February), Phalguna (March), Chaitra (April), Vaishakha (May), Jeyshta (June), Aashadha (July), Shravana (August), Bhadrpada (September), Ashwin (October), Kartika (November), Maragashirsha (December).
4. **Paksha** - Each month is divided into two fortnights called Shukla Paksha corresponding to the bright fortnight and Krishna Paksha corresponding to the dark fortnight.

2.5.4 Prediction of Monsoon Rains

The ancient/indigenous methods of weather forecast may be broadly classified into two categories:

I. Observational Methods

- Atmospheric changes
- Bio-indicators
- Chemical changes
- Physical changes
- Cloud forms and other sky features

II. Theoretical Methods or Astrological Factors or Planetary Factors

- Computation of planetary positions and conjunctions of planets and stars
- Study of solar ingress and particular dates of months
- Study of Nakshatra Chakras
- Study of Nadi Chakras
- Dashatapa Siddhana

1. **Parashara's technique** of 'rain forecast' is based on the positions of the Sun and the Moon.

<i>Sign of the sun</i>	<i>Sign of moon</i>	<i>Predicted annual rainfall</i>
Cancer	Gemini, Aries, Taurus, or Pisces	100 adhakas
Leo or Sagittarius	Gemini, Aries	50 adhakas
Virgo or Leo	Gemini, Aries, Taurus or Pisces	80 adhakas
Cancer, Aquarius, Scorpio, or Libra	Gemini, Aries, Taurus or Pisces	96 adhakas

Method for measurement of rainfall - Varahimira defined one adhaka equivalent to 50 palas of water. Adhaka is a measure of rainwater quantity in a land expanse of 100 yojanas in length and 30 yojanas in depth. The following formula will help to understand this concept clearly. 1 yojana = 4 kroschas = 8 miles = 13 km. Hence $\frac{1}{4}$ yojana = 1 kroscha = 3.2 km. If the rain water wets a land area of approximately 100 yojanas (or $100 \times 13 = 1300$ km) in length and 30 yojanas (or $30 \times 13 = 390$ km) in width (depth is interpreted as width), then it qualifies for an earthly measure of one adhaka. For measurement of rainfall or rainwater the unit of rain-gauging was adhaka. An adhaka is the quantity of rainfall which fills to the brim of a vessel 20 inches in diameter and 8 inches deep. Four such adhaka constitute one drona. The method of measurement of rainfall is described by Varahamihira in PART 23 entitled "Pravarshan Adhyaya" (PART on rainfall) of his book. A circular vessel with a diameter equal to one (human) arm or the distance measured by the width of 20 (human) fingers and with a depth equal to the distance measured by the width of (human) fingers and with a depth equal to the distance measurement by the width of eight fingers should be accepted for measurement of rainfall. When this vessel is completely filled with rainwater, the rainfall should be equal to 50 palas or one adhaka this method has been explained by the seer Parashara. Parashara's basic unit of measuring rainfall is adhaka. One drona = 4 adhakas = 6.4 cm.

According to Parashara the basic unit of rainfall is adhaka.

$$1 \text{ adhaka} = 17600 \div 7 = 2514 \text{ cubic finger} = \frac{1}{4} \text{ drona} \quad [\text{eq 1}]$$

$$\text{Volume of the vessel} = \pi r^2 d = 3.14 \times 10^2 \times 8 = 314 \times 8 = 2512 \text{ cubic fingers} \quad [\text{eq 2}]$$

Where $\pi = 3.14$, r = radius of the vessel = 10 fingers-width and d = depth of the vessel = 8 fingers-width

Three units used to measure rainfall in ancient India were Pala, adhaka and drona (50 palas = 1 adhaka = $\frac{1}{4}$ drona). These ancient units can be related to the modern ones using the relation 2514 cubic fingers of rainwater or 1 adhaka is equal in weight to 11 oz or 311.85 g. As 1 cc of water weighs 1 g, so

$$1 \text{ adhaka} = 2514 \text{ cubic fingers} = 311.85 \text{ cc} \quad [\text{eq 3}]$$

In a modern rain-gauge with a 200 cm² container, volume of 1 cm of rainwater collected is

$$200 \text{ cm} \times 1 \text{ cm} = 200 \text{ cc} \quad [\text{eq 4}]$$

Based on equation 3, rainfall measured using the ancient method could be related to modern units as:

$$1 \text{ adhaka} = 311.85 \div 200 = 1.6 \text{ cm} \quad [\text{eq 5}]$$

[i.e., volume of rainwater \div area of container = amount of rainwater collected (see equation 4)]

From equations 1 and 5

$$1 \text{ drona} = 4 \text{ adhaka} = 6.4 \text{ cm} \quad [\text{eq 6}]$$

2. Parasara's rainfall prediction - Every year has (a particular planet as) a ruler, (another planet as) a minister, a particular cloud, and (depending on that) an amount of rainfall which one has to study to acquire the knowledge of rains. The method of finding out the ruler (planet) of the year: Multiply the number denoting the Saka year by three. Add two; divide the result by the number of sages (i.e., seven). The remainder is the number indicating the ruling planet of that Saka year. The planet, which is fifth

form the ruler planet, indicates the minister planet of that year. The minister planet of the year is Venus as it is the fifth from the Sun. $1920 \times 3 = 5760$

$$5760 + 2 = 5762$$

$$5762/7 = 823 + \text{remainder } 1$$

The Sun as the ruler of the year indicates average rainfall, the Moon heavy rains, Mars scanty rains, and Mercury goods rains. When Jupiter happens to be the king of the year the rainfall is satisfactory, Venus indicates excellent rainfall while Saturn as a king leaves the earth dry and dusty. Diseases of the eye, threat of fever, and all sorts of other calamities, scanty rainfall and continuous blowing of winds are the characteristics of a year ruled by the Sun. The year in which the Moon is the ruler is sure to enrich the earth with good harvest and bestow health on mankind. In the year ruled by Mars, damage is caused to the crops and diseases spread among people. The earth becomes benefit of crops. When Mercury happens to be the ruler, earth is free of diseases. Transportation is easy and there is plenty of harvest. The earth is blessed with all the varieties of crops. If Jupiter rules the year, Dharma prevails on earth, people enjoy peace of mind, There is good rainfall. The whole earth enjoys prosperity. Venus the preceptor of demons, as a ruler of the year causes the kings to prosper without fail. Prosperity and plenty result. The earth is blessed with a variety of food grains. The year in which Saturn rules war, stormy rains and outburst of diseases are sure to occur. Rains rare scanty and winds are continuous.

Table 2.4. Annual Rainfall and Crop Yields Depending on the Ruling Planets of the Year

<i>Name of the ruling planet of the year</i>	<i>Estimated rainfall for the year</i>	<i>Crop yield during the year</i>
Sun	Average or scanty	Poor crop yield*
Moon	Heavy	Good harvest
Mars	Scanty	Damage to crops
Mercury	Good	Plenty of harvest
Jupiter	Satisfactory	Good harvest*
Venus	Excellent	Variety of food grains
Saturn*	Scanty	Poor yield

*Saturn—The earth is dry and dusty, continuous winds occur during this period.

3. A model for forecasting seasonal rainfall recorded in Brhat Samhita - Varahamihira (600 A.D.) evolved or adapted a technique based on science. This technique lays down that after the occurrence of the full-moon day of the month of Jyestha (approximately coinciding with June of Gregorian calendar) the asterism or lunar mansion or nakshatra of the day on which the first rainfall of that year rainy season is received should be noted. This asterism provided the basic for the forecast of seasonal rains. The predicted amount of the season's total rainfall for each nakshatra or lunar mansion if it happens to be the nakshatra on the first rainfall of the season is listed (Table 2.6). The first rainfall of the season that occurred after the full-moon day of the month of Jyestha (approximately June) is taken into account for forecasting the seasonal rainfall, but the amount of rainfall recorded on that day has not been indicated. Modern meteorology defines a rainy day as a day on which a rainfall of 2.5 mm or more has been recorded.

4. The method of ascertaining the type of cloud of the year - Add the types of fire (which is three) to the number denoting the Saka year. Divide the sum by the number of vedas (which is four). The remainder of the division indicates the type of cloud, viz., Aavarta, etc., according to their order.

Table 2.5. Varahamihira's Technique for Forecasting Seasonal Rains

Lunar Mansion	Zodiac sign		Predicted total seasonal rainfall	
	Sanskrit	English	In ancient units (drones)	In modern units (cm)
<i>Hasta</i>	<i>Kanya</i>	Virgo	16	102.4
<i>Purvashadha</i>	<i>Dhanu</i>	Sagittarius	16	102.4
<i>Mrigashirsha</i>	<i>Vrushabha</i>	Taurus	16	102.4
<i>Chitra</i>	<i>Kanya</i>	Virgo	16	102.4
<i>Revati</i>	<i>Meena</i>	Pisces	16	102.4
<i>Dhantishtha</i>	<i>Makara</i>	Capricorn	16	102.4
<i>Shatabhisha</i>	<i>Kumbha</i>	Aquarius	4	25.6
<i>Jyeshtha</i>	<i>Vrushchika</i>	Scorpio	4	25.6
<i>Swati</i>	<i>Tula</i>	Libra	4	25.6
<i>Kritika</i>	<i>Vrushabha</i>	Taurus	10	64.0
<i>Shravana</i>	<i>Makara</i>	Capricorn	14	89.6
<i>Magha</i>	<i>Simla</i>	Leo	14	89.6
<i>Anuradha</i>	<i>Vrushchika</i>	Scorpio	14	89.6
<i>Bharani</i>	<i>Mesha</i>	Aries	14	89.6
<i>Mula</i>	<i>Dhanu</i>	Sagittarius	14	89.6
<i>Purvaphalguni</i>	<i>Simla</i>	Leo	25	160.0
<i>Punarvasa</i>	<i>Mithun</i>	Gemini	20	128.0
<i>Vishakha</i>	<i>Vrushchika</i>	Scorpio	20	128.0
<i>Uttarashadha</i>	<i>Makara</i>	Capricorn	20	128.0
<i>Aaslesha</i>	<i>Karka</i>	Cancer	13	83.2
<i>Uttarabhadrapada</i>	<i>Meena</i>	Pisces	25	160.0
<i>Uttaraphalguni</i>	<i>Kanya</i>	Virgo	25	160.0
<i>Rohini</i>	<i>Vrushabha</i>	Taurus	25	160.0
<i>Purvabhadrapada</i>	<i>Kumbha</i>	Aquarius	15	96.0
<i>Pushya</i>	<i>Karka</i>	Cancer	15	96.0
<i>Ashwini</i>	<i>Mesha</i>	Aries	12	76.8
<i>Aradra</i>	<i>Mithun</i>	Gemini	18	115.2

1. On the day of the first rainfall of the season.

2. 1 drona = 6.4cm.

Let the Saka year is 1920. The $1920 + 3 = 1923$; $1923/4 = 480 + \text{remainder } 3$. Hence the type of cloud is the one listed at number 3. Pushkara cloud is stated at number 3 in the order. Therefore the cloud of the Saka year 1920 is Pushkara. Aavarta, Samvarta, Pushkara, and Drona are the four types of clouds, Aavarta being the first in order. **Aavarta** rains at some parts while **Samvarta** rains everywhere. Water is scanty in Pushkara cloud while drona makes the earth full of water. The rains from Aavarta cover some parts of the earth. The students of modern Indian science of meteorology will identify this type

of cloud, Aavarta, with the present day *cumulonimbus*, which gives thundershowers over a limited area. It is a result of the special feature of its build up in the sky with a base at about 2500–3000 ft (about 750–900 m) above ground and with a vertical ascent of 25,000–30,000 ft (about 7–9 km) above its base. The second type of cloud, samvarta, rains everywhere indicating that it is a sheet type of cloud, *an altostratus*, which is widely spread in the sky, at a height from 2.5 km to 6.0 km above sea level. The thickness of the sheet cloud can be considerable, rendering the Sun invisible during the period of its spread in the sky. The third type of cloud is Pushkara and the year with this type cloud is known for scanty rainfall. The name Pushkara or Pushkal shows that it is a cloud of short duration as its buildup is a temporary phenomenon or a disturbance in the normal atmosphere. The last type, Drona, makes the earth full of water according to the sage Prarasha. It is the stratocumulus cloud type, which is a sheet-cloud at a height of approximately 2 km above ground. This type also gives steady, continuous rain. According to Varahamihira and other scholars the formation of clouds or pregnancy of clouds or Garbha Dharana takes place 195 days before fall or birth or delivery or 'Garbha Prasava'.

5. The method of determining the amount of rainfall - Experts have fixed *adhaka* (jalaadhaka) as the measure of water which is the quantity of water contained in an expanse of a hundred *yojanas* and the depth of thirty *yojanas*. When the Sun enters the sign of cancer while the moon is in Pisces, Aries, Taurus or Gemini, the rainfall is a hundred adhakas. If the sun passes through Leo and Sagittarius it is half of that (*i.e.*, fifty adhakas). When the sun is in the Virgo or Leo rainfall is stated to be eighty adhakas. When the Sun is in Cancer, Libra, Aquarius, the rainfall is said to be ninety-six adhakas. Farming should be planned after studying the quantity of rainwater.

6. Sudden rainfall - If an expert on predictions of rainfall is approached with query regarding rains while he is taking a dip in water or has water in his hand or is the variety of water, sudden rains can be predicted. Ants emerging (from the ant hill) carrying their eggs and a sudden croaking of frogs are also indications of sudden rains. Cats, mongooses, snakes, other creatures which live in holes as well as grasshoppers moving around freely as in a state of intoxication are also sure signs of sudden rains. Children playing on the road and building bridges of mud, and peacocks dancing also indicates sudden rains without fail. People suffering from injury or vatadosha (human disorder similar to wind humor) complaining of body pain and snakes climbing on the treetops also bespeak of sudden rains. Water birds drying their wings in the hot sun and crickets chirping in the sky also signify sudden rains.

7. Indications of famine - Mar's transit through Dhruva (Uttaraphalguni, Uttarashadha and Uttarabhadrapada nakshadars), Vaishanava (Shravana), Hasta, Mula, Shakra (the master of Jyeshtha), Kritika, and Magha indicates famine. The sun situated behind Mars evaporates even the ocean while in an opposite situation, he drenches mountains too. Obstruction to rain as soon as Venus reaches the middle of its path through Chitra. Mars passing through Leo turns the earth into a fireplace, and accompanied by the Sun can evaporate even the ocean.

8. Kautilya's Artha-Sastra (400 B.C.) - Kautilya's Artha-Sastra describes the technique for measuring rainfall for a location. A circular vessel with a diameter equal to the length of human arm (which is equal to the distance measured by the width of twenty fingers of a human hand) and a depth equal to the distance measured by the width of eight fingers (in modern unit, the diameter and the depth would approximately 38 cm and 13 cm respectively) was used to collect the rainwater. When this vessel was filled with rainwater collected open space, rainfall was measured to be 50 palas or one adhaka or ¼ drona. An adhaka of rainfall is equal to 1.6 cm rainfall in modern units of measurement and a drona is 6.4 cm. Kautilya gives the amounts of rainfall received in the rainy season over different regions of India (Table 2.7).

Table 2.6. Distribution of Rainfall during the Rainy Season in the 4th Century B.C. in India

<i>Ancient name of the region</i>	<i>Modern name of the region</i>	<i>Amount of rainfall in ancient and modern units</i>	
		<i>(dronas)</i>	<i>(cm)</i>
Ashmaka	Marathwada	13	83.2
Aratta	Western Maharastra	13½	86.4
Avantika	Ujjain city in Madhya Pradesh	23	147.2
Malwa	Western Madhya Pradesh	23	147.2
Aparanta	Konkan (coastal Maharashtra)	Unlimited	Unlimited
Hilly areas in North	Himachal Pradesh	Unlimited	Unlimited

The beginning of the rainy season in north west India occur when the sun starts moving south, *i.e.*, after 21 June. The rainy season extended over four months of the Hindu calendar viz., Shravana (August), Bhadrapada (September), Ashwin (October) and Kartika (November). Kautilya predicted excellent crop production if one third of the total rainfall is received in the first and the last months and two third in the intervening two months during the four months of rainy season. Continuous rains for seven days, 80 days showering drops and sixty days intermittent showers alternating with sunshine were considered even and beneficial.

A. Varahamihira's Brihat Samhita on Weather Forecast

In Brihat Samhita, Varahamihira devotes eight parts to the science of forecasting rain. Weather forecast can be made with considerable accuracy only on the basis of observing process taking place in the Sun, which in their turn, are correlated to certain planetary juxtapositions. Changes in the weather are associated with the Sun, the Moon and other planets under certain conditions of positions, either when they act alone or in combination. Varahamihira had dealt the sunspots and their effects on earth. Periods of very heavy rainfall (flooding) also coincide with sunspot maxima. The appearance of these spots would bring thunderbolts, earthquakes and such unusual phenomena boding calamity. Every 11 years or so there are great bursts of solar activity. During the maximum periods, there is an acceleration of the "earth's heartbeats" causing a larger number of earthquakes. Sunspots also cause the eruption of violent winds releasing charged corpuscles, which cause terrestrial magnetic storms. Sun's disc spot is in the form of wedge, there will be famine. The solar wind is more 'gusty' around the time of maximum solar activity. When the Sun is more active, producing flares and spots, the solar wind contains more high-speed streams. And these high-speed streams are very likely to affect the weather on the earth. Direct evidence linking sunspots and the weather comes from records of the occurrences of storms and lightning. The annual lightning incidence (which is a measure of the number of lightning flashes occurring in a given area each year) closely follows the mean sunspot index.

B. Principles of Astro-meteorology

The Hindu astrological method of predicting rainfall a scientific method spread over a period of at least six months observation stage by stage. There is a need to study the garbhadharan (impregnation) of the clouds towards the fag end of Dakshinayan (July 17 to January 13) on the particular day when the moon enters a particular constellation (or nakshatra) this should be done to predict rains during the Indian monsoon. Similarly, for winter rains the garbha dharan is to be observed in the Uttarayana period (January 14 to July 16). The following principles are being given for rainfall predictions:

Principle No. 1: According to **Varahamihira**, the formation of clouds or pregnancy of clouds or 'Garbha Dharana' takes place 195 days before their fall or birth or delivery or 'Garbha Prasava'. There are actually twenty seven nakshatras (constellations) for the purpose of astro-meteorology. Apart from these, the twenty eighth nakshatra 'abhijit' is also allotted a space towards the end of Uttarashadha (No. 21).

Sapta Nadi Chakra and its Relation with Rain Occurrence

<i>Seven nadis</i>	<i>Nakshatra or asterism or constellation</i>	<i>Effect on weather</i>
Chandanadi, Prachand, (Fierce)	Krittika (3), Vishakha (16), Anuradha (17), Bharani (2)	Bright sunshine, No rainfall
Dahananadi or Vatanadi or Paman (windy)	Rohini (4), Swati (15), Jyeshtha (18), Ashvini (1)	Sunshine and wind, Normal rainfall
Vayunadi, Vanhinadi, Dahan (hot)	Mrigashira (5), Chitra (14), Mula (19), Revati (27)	Strong hot wind (Westerlies)
Soumyanadi (weather changes)	Ardra (6), Hasta (13), Poorvashadha (20), Uttaraproshtapada (26)	Normal rainfall
Neeranadi (good rain)	Punarvasu (7), Uttarphalguni (12), Uttarashadha (21), Poovaproshtapada (25)	Very good rainfall
Jalanadi (better rain)	Pushya (8), Poovaphalguni (11), Abhijit, Satabhisha (24)	Abundant rainfall
Amritanadi (best rain)	Ashlesha (9), Magha (10), Sravana (22), Dhanista (23)	Heavy to very heavy rainfall causing flood

Planets And Nadi's Impact on Rain During Winter Solstice (Dakshinayana)

<i>Planets</i>	<i>Nadi</i>	<i>Effects on weather</i>
Sun, Mars, Saturn	Saumya	Ordinary rain
Jupiter, Venus, Mercury, Moon	Saumya	Good rain
Jupiter, Venus, Mercury, Moon	Vayu, Chada, Dhana	Ordinary showers
Sun, Mars, Saturn	Vayu, Chada, Dhana	No rain

There are actually twenty seven nakshatras (constellations) for the purpose of astrometeorology. Apart from these, the twenty eighth nakshatra 'abhijit' is also allotted a space towards the end of Uttarashadha (no. 21).

How Asterisms regulate weather - Aswini, Krittika, Rohini, Purvabhadra, Uttarabhadra, Anuradha, Sravana, Punarvasu, Pushya are masculine; Bharani, Hasta, Chitta, Swati, Visakha, Pubba, Uttara, Aslesha, Makha, Jyeshtha, Aridra, Dhanishta, Purvashadha and Revati are feminine; Satabhisha, Mrigasira and Moola are neutral. When the Sun and the Moon are in neutral asterisms there will be winds; when they are in feminine asterisms there will be lightning and phosphorescence; and when the Sun occupies a feminine asterism, and the Moon a masculine asterism, or vice-versa there will be rains.

Principle No. 2. When many planets are in one Rashi preferably in one nakshatra, it affects the weather. When many planets gather in one rashi with Mars and Sun joining them and Mars is with Rahu, there can be a terrible downpour even if it is not regular monsoon season. When there is

concentration of planets in one rashi. The weather begins to fluctuate and which moon joins them, there will be heavy downpour. Cancer, Pisces and Capricorn are full watery signs; Taurus, Leo and Aquarius are half watery signs; Aries, Libra and Scorpio are quarter watery signs while Gemini, Virgo and Sagittarius are not watery signs. Moon and Venus are full-blown watery planets. During Winter solstice (Dakshinayana) malefic planets (Saturn, Sun, and Mars) transiting through the Amrita, Jala and Neeranadis, would give rise to ordinary rains. If benefic planets transit the above constellations, there will be plenty of rain.

Principle No. 3. Whatever may be the season, there must be weather–fluctuation when Moon joins Venus or when Moon is fifth or ninth from Venus in the rainy season it causes good rain unless there are factors preventing rains.

Principle No. 4. When Mars transits from one Rashi into another within two days there is a perceptible change in weather and in the rainy season there must be a good rainfall. Mars is the most powerful planet causing rainfall.

Principle No. 5. Similarly when a major planet (such as Jupiter, Saturn, Rahu and Ketu into a fiery, earthy, watery or airy sign) changes a Rashi, it causes momentous events. In case of weather, it must cause a very noticeable change in weather.

Principle No. 6. When planets retrograde and on the days they direct there is a change in temperature, humidity and what the meteorologists describe as “disturbance” causing rainfall, etc.

C. Principles are Used to Predict the Dates/Occurrence of Rainfall In India

- After the sun has entered Mrigshira nakshatra towards the end of May the south-west monsoon begins to strike Kerala coast. When sun enters Ardra (22-23rd June) every year monsoon advance towards northern India.
 - When sun reaches and crosses six degrees in Gemini, the monsoon arrives in North India (around June 22) and when sun reaches ten degrees in Virgo on September 26 the monsoon begins to withdraw in North India.
 - When the sun enters Hasta nakshatra, it causes rain in Bihar, which is known to an average Bihar farmer as Hathiya rain. But by that time monsoon withdraws from the rest of northern India.
 - When the sun enters Chitra, it continues to cause rain in Bihar particularly in north-east India.
 - When the sun enters Swati. It causes some occasional rain otherwise the south-west monsoon withdraws totally, in Indian tradition there is reference to the bird called chatak which supposedly waits for the rain-drop of swati.
 - The moon, in certain positions, ‘nakshatras’ (constellations/star) joining, with other planets or when inspected by them can cause or hinder rain. Planets will be placed in the nakshatras given above (in the Sapta Nadi Chakra Table).
 - There will be rain when Mercury transits Cancer and join Venus in the north India after August 3.
 - The presence of Jupiter and Venus together in Rohini star shows torrential and untimely down pour of rains.
 - Mars and Rahu together inspected by Saturn causes lightening and cloud bursts.
 - Cyclones on the Andhra Pradesh coast are likely to occur close to periods of sunspot maxima when the planets Jupiter, Saturn, Rahu (Ketu) and Uranus form even loose aspects of Kendra (square) and Samagama (conjunction) between themselves. These indications are strengthened whenever either Virgo or the 12th from it are afflicted.
- (i) **Rain gauging** - According to Varahamihira, rainfall should be collected in a vessel whose capacity is an adhaka. An adhaka has been defined as the quantity of rainfall, which falls to the

brim of a vessel 20 inches in diameter and eight inches deep. Four such adhakas constitute a drona. If conception of clouds is due to all the five conditions of wind, rain, lighting, thunder and clouds, says Varahamihira, then the quantity of subsequent rainfall will be one drona and this will fall over an area of 400 square miles. If the conception of clouds has been due to wind alone, the resultant rainfall will be three adhakas. If due to lightning, the rain will be nine adhakas. If due to thunder and other factors affecting rainfall, twelve adhakas.

- If there is rain on the day on which the Moon asterism is either Hastha or Poorvashadha or Mirgasira or Chittra or Revathi or Dhanistha, then on the corresponding days of the next lunar month, there will be 16 dronas of rainfall.
 - If there is rain on the day on which the Moon asterism is either Sravana or Makha or Anuradha or Bharani or Moola, then on the corresponding days of the next lunar month, there will be 14 dronas of rainfall.
 - If the Moon resides in either Satbhistha or Jyestha or Swathi, there would be 4 dronas of rainfall on the corresponding days of the rainy seasons. If in Krittika, 10 dronas; If in Poorvaphalguni, 25 dronas; If in Vishakha or Uttarashadha, 20 dronas; If in Ayslesha, 13 dronas; If in Uttarabhadrapada or Uttaraphalguni or Rohini, 25 dronas; If in Aswini, 13 dronas; If in Aridra, 18 dronas.
 - If the moon in above asterism suffer from malefic influence either aspect or conjunction, there will be neither rain nor prosperity in the land. If the benefic planets pass through above asterism or the moon in above asterism should remain unaffected by malefic, rainfall would be good.
- (ii) **Hour of rainfall** - The very hour of the occurrence of rainfall can also be determined; for, says Varahamihira, clouds 'conceiving' during the day will be delivered at night and clouds 'conceiving' at night will be delivered during the day; clouds 'conceiving' in the twilight of the evening deliver during the morning twilight, and vice-versa. Again, if at the time of conception, clouds have appeared in the east, then at the time of birth, they will appear in the west; and so on with the other quarters. Similarly, if at the time of conception the wind has blown from the east, then at the time of rain, it will blow the opposite quarter.
- (iii) **Rain in the immediate future** - While ancient meteorology can predict rain long in advance, is it no difficult thing to forecast rain in the immediate future. During the rainy season, immediate rainfall is indicated: If the sun at the time of rising is exceptionally bright and red, or If the taste of water is insipid, or the color of the sky or sunset rainbow is seen in the sky, or If salt begins to sweat, or If fish in tanks jump from water on the bank, or If metal vessels emit a fishy smell, or If ants, with their eggs, move from one place to another.
- (iv) **Forecasting rainfall, floods and weather vagaries** - Of the several methods recommended by classical writers for forecasting rainfall, floods and weather Vagaries, the most important ones are: (a) the lunar new year chart, (b) time of pregnancy of clouds, (c) entry of the Sun into the constellation of Aridra, (d) Sun's entry into Capricorn, (e) Rohini, Swati, and Ashadha Yogas, and (f) mutual dispositions of planets at a given time.

D. Effect of Planets on Weather Parameters

The Sun in contact with Mercury gives windy spells. Similarly, Sun + Venus gives rain or snow; Sun + Mars gives warmer climate according to the season; Sun + Jupiter gives dry or drought; Sun + Saturn gives colder than normal in the season; Sun + Rahu gives local storms and Sun + Ketu gives very changeable climate within a short space of time. According to Garga and other sages, the clouds become pregnant from the day the Moon reaches the constellation of Poorvashadha in the bright half of the lunar month Mirgasira (about 3rd week of November each year).

While the Moon's varying distance from the sun, *i.e.*, lunar day or *tithi* is a potent factor in weather changes, there is overwhelming evidence that the major planets have a powerful influence over atmospheric eventualities. Many tropical storms have whirled to hurricane intensity on the three days centered at new Moon and full Moon. Heavy rain occurred most frequently about four days after full Moon and reached a secondary peak about four days after new Moon. In other words the greatest amount of rain fell when the Moon is either 45 or 225 degrees from sun. A clear correlation persists between the movements of the Moon and variations in quantities of rainfall. When a planet enters Cancer it well influence the weather more in the northern hemisphere while the southern hemisphere is more influenced when planets enter the sign Capricorn. Mars and dry weather: Coming to the planet Mars, it raises the temperature, causing a dryness in the weather, especially when in Aries. Mars in conjunction with Jupiter exerts a disturbing effect on the weather, and storms of rain and thunder occur during the rainy season. Thunder, lightning and inundations are the outcome of Saturn-Mars influences.

When Mercury and Venus pass the Sun, usually wet and windily weather occurs. The position of the Sun at times of new Moon and season-changes will give the observer a clue as to the type of weather likely during a specified period of time. When Mercury and the Sun are in conjunction during the winter a blizzard or a cold wave occurs. When Mercury and the Sun are in superior conjunction followed by Mercury's conjunction with or opposition to Mars, and Rahu conjuncts Sun, a fast moving cold wave may be brought about. Temperatures may fall rapidly. Mercury and Saturn in mutual aspect may keep the area of rising temperatures limited. An aspect of Venus can bring moist warm air and a promise of moderate to heavy rain or even storms or tornadoes. Venus retrogression or direct motion does not singly affect weather unless it is accompanied by other planets. A retrograde Jupiter is good for rains. A retrograde Saturn is not beneficial for rains. How the winds are influenced: Mercury generates acute, sharp and whipping winds; Venus generates sunny weather consistent with the season; Mars gives rise to energetic watery winds and abnormally hot summers, and Saturn's action is frequently related to chronic cloudy skies and abnormal rainfall. Greatest numbers of fires observed at the time of the full Moon. When the planet Jupiter is in perihelion there is a great drought and likewise when in aphelion there is more dampness and cold weather than usual. The slower moving planets (especially Jupiter and Saturn) exert a telling influence, because of their slow speed and their great masses for a longer period of time.

(i) Role of planets on occurrence of rain or flood or drought or famine

- When sun is between Venus and Mercury there is a break in monsoon in the sense that for some days there is dry spell.
- Sun being behind Mars in the rainy season, there will be poor rain or rain is delayed or will create dry spells. When the Sun was overtaking Mars, there will be heavy downpour of rains, causing flood in rivers.
- Rain will not be timely when all quadrants being occupied by malefic.
- Mars, affected by other malefic, will create dry spells till August.
- If Jupiter and Mars are within 30 degrees (thirty degrees) of each other it prevents rains.
- If the Moon is in the 7th from Venus and within view of benefic planets, or be in the 5th, 7th or 9th house from Saturn there will be immediate rain.
- When Venus is in constellations of Swathi, Vishakha and Anusha, unprecedent rainfall results in heavy floods.
- Famine will break out for want of rains when Venus is in one of constellations from Jyestha to Sravana.
- There will be drought condition when Venus sets in or retrogrades in Makha or Uttarashadha.

- Clouds become scattered and rainfall disturbed, when the sun, Mars and Venus transit the same sign. If Jupiter joins the above combinations, clouds will deliver rains in plenty.
- When Jupiter retrogrades in Rohini, the year will have less rainfall.
- Heavy rain results when Jupiter is in Pisces while Venus is in Cancer.
- Droughts are noticed when Saturn is unaspected in Aries, Leo or Sagittarius.
- When Mars and Saturn are in conjunction, rainfall will be very low.

E. General Signs that Bring Rain

- Soft, white, deep halo round the Moon or the Sun.
- Dark colored sky, dark as the crow's egg.
- Sky overcast with huge, bright, dense clouds.
- Needle-shaped clouds.
- Blood-red clouds.
- Rainbow in the morning or in the evening.
- Low, rumbling roar of thunder.
- Lightning.
- The appearance of the mock-sun; and
- Planets shine in full form and with soft light.

F. Animal Behaviour to make Medium Range Forecasts

The plants, birds and animal behaviour are used to predict medium and short-range forecasts.

- In the rainy season when the sky is cloudy try to take your pet dog outdoor. If the dog shows a disinclination, it is a sign of coming rain.
- See if kites in flock are flying at a height of about 400 ft. It is an indication of rain or storm.
- See if any spider has started weaving its web outdoors. It indicates the departure of the monsoon.
- Those who are lucky to have some frogs alive and croaking can get the indication from their croaking.
- The exultant cry of the peacock is an indication of cloud formation.
- Early flowering of the gulmohur and amaltas was an indication of a good monsoon.
- Rain bird; if the rain bird gives eggs at the ground level then there will be less rain however if the indication of more rains the local people assume that eggs of rain bird are laid on such a height that in case of more or less rains, the eggs will not be submerged in rainwater. Similarly if the narrow ends of all the four eggs of rain bird are downwards, and then it is the indication of good rainfall thought out the season.
- When the adventitious roots of the banyan tree (*Ficus bangalensis*) start spouting (tillering), then the local people assume that the rains will appear within 2 to 4 days.
- When the buds start spouting in castor and ber, then rains will appear within 10 to 15 days.
- The rains will appear after 10–15 days of flowing in babul tree (*Acacia nilotica*).
- As soon as the neem kernels ripen and start falling, it is expected that there will be rains after 10–15 days.

2.6 ALMANAC, PANCHANG AND KRISHI-PANCHANG

According to the Encyclopedia Britannica (1969), An Almanac is a book or table containing a calendar of the days, weeks, and months of the year, a register of ecclesiastical festivals and saint's days and a record of various astronomical phenomena, often with weather prognostications and seasonal suggestions

for the countrymen”. In India, the classical Hindu astrological almanac is known as ‘Panchang’. Panchang has been prepared for public use from Vedang Jyotish period 1400-1300 B.C. The word ‘Panchang’ has derived from the Sanskrit words *viz.*, ‘panch’ and ‘ang’, which mean ‘five’ and body part/limb’ respectively. These parts are: (1) Tithi or lunar day; (2) Vara or week day; (3) Nakshatra or asterism or constellation; (4) Yoga or time during which the joint motion of the sun and the moon covers the space of a nakshatra and (5) Karana or half of a lunar day or half-tithi.

- (i) **Tithi** - The fifteenth day of the bright half is called Purnima, Purnima, or Purnamasi. It is generally considered an auspicious day. The fifteenth day of the dark half is called Amavasya. It is called ‘Kuhu’ when the Moon is totally absent and ‘Sinivali’ when the moon is partially absent. It is generally considered an inauspicious day. The fourth, ninth, and the fourteenth days are called ‘Rikta’, *i.e.*, empty days and are not recommended for commencing any new project.
- (ii) **Vara** - There are seven days in a week named after the seven principal ‘planets’ (old concept) *viz.*, Sun, Moon, Mars, Mercury, Jupiter, Venus and Saturn and they are believed generally to possess the characteristics of the respective planets.
- (iii) **Nakshatra** - Nakshatra are constellations of stars. There are twenty seven (or twenty eight) nakshatras enumerated in a fixed order marking the Moon’s heavenly path. Each nakshatra is divided into four padas, or charanas, *i.e.*, quarters. Nine consecutive padas fall in one rashi, *i.e.*, the zodiacal sign.
- (iv) **Rashi** - Rashis are the twelve zodiacal signs that mark the imaginary or the apparent path of the sun through space. *e.g.*, Mesha (Aries) and Vrishaba (Taurus). The sun takes approximately one month to pass through one sign (and takes thirteen to fourteen days to pass through one nakshatra).

A. Rain Forecasting in Indian Almanacs (Panchangs)

According to the Encyclopedia Britannica (1969), “An almanac is a book or table containing a calendar of the days, weeks and months of the year, a register of ecclesiastical festivals and saint’s days and a record of various astronomical phenomena, often with weather prognostications and seasonal suggestions for the countrymen”. In India, the classical Hindu almanac is known as ‘Panchang’. It is a very important book published yearly, and is the basic book of the society giving calenderical information on daily basis and is extensively used by the people all over India. For astrologers, it is one of basic books for making astrological calculations, casting horoscopes, and for making predictions. For farmers, it is an astrological guide to start any farming activity. Hence, it is a fundamental book, which is referred to by a large section of the people in this country for various purposes. The word ‘Panchang’ has its roots in two Sanskrit words, *viz.*, ‘panch’ and ‘ang’, which mean ‘five’ and ‘body part/limb’ respectively. These parts are: (1) Tithi or lunar day - there are a total of thirty tithes in a lunar month, fifteen in each fortnight; (2) Vara or week day - there are seven varas, namely, Ravivara (Sunday), Somavara (Monday), Mangalavara (Tuesday), Budhavara (Wednesday), Guruvara (Thursday), Shukravara (Friday), and Shanivara (Saturday); (3) Nakshatra or asterism or constellation - there are a total of twenty seven nakshatras named according to the yogataras or identifying stars of each of the twenty seven equal parts of the ecliptic or solar path; (4) Yoga or time during which the joint motion of the Sun and the Moon covers the space of a nakshatra (there are twenty-seven yoga) and (5) Karana or half of a lunar day or half-tithi.

(a) **Krishi-Panchang** - Krishi-Panchang or Agro-almanac or Agro-panchang may be defined as “basic astro-agricultural guide book/calendar published annually, giving calenderical information on various aspects of agriculture and allied activities, basically suggesting region-wise, season-wise and crop-wise crop strategy based on astro-meteorological predictions, giving auspicious/inauspicious time for undertaking/avoiding various farm related operations, along with a list of performing religious rites,

festivals, observing fasts and some non-astrological guidance, primarily useful for the farming communities and person having interest in agricultural development”.

- (i) **Making of Krishi-Panchang** - A *Krishi-Panchang* may be defined as “basic astro-agricultural guide book/calendar (that needs to be) published annually, giving calenderical information on various aspects of agricultural and allied activities, basically suggesting region-wise, season-wise, and crop-wise crop strategy based on astro-meteorological predictions, giving auspicious/inauspicious time for undertaking/avoiding various farm-related operations, along with a list for performing religious rites, festivals, observing fasts, and some non-astrological agricultural guidance, primarily useful for the farming communities and persons having interest in agricultural development”.
- (ii) **Content and coverage proposed** - The *Krishi-Panchang* should be basically different from the present-day *panchangs* in its content and coverage, method and approach of writing, composition of editorial boards, publication, and circulation. The *Krishi-Panchang*, being meant for meeting agricultural purposes, majority of its contents should relate to agricultural information. In addition to this, basic information such as annual date calendar, list of holidays, auspicious days/moments of the coming year should be given for the benefit of farming communities.

The contents of the proposed *Krishi-Panchang* can broadly be categorized in two major groups as follows:

1. Information, which changes every year

- Annual date and Holiday calendar
- Month-wise daily guide for the whole year
- “*Rashiphal*”, i.e., month-wise forecasting of persons having different zodiac signs
- Daily/monthly/annual weather forecasting for the particular year
- Crop prospects of that year based on planetary positions
- Season-wise crop strategy based on anticipated weather

2. Information, which remains same irrespective of any particular year

- Theories relating to agricultural and meteorological forecasting
- Auspicious moments for agricultural and allied activities
- Some general agricultural guidance

In ancient India, success in agricultural operations was determined from the position and movement of heavenly phenomena at the time of commencement of the particular practices. The beneficial or malefic influences were mostly valued at the time of ploughing and sowing. On the basis of position of planets, *nakshatras*, and other celestial bodies at any particular moment, and their influence on both materials as well as non-materials, living as well as non-living, Hindu astrologers (*Jyotishis* or *Hyotishacharyas*) have written several “*Muhurta Granthas*” (books on auspicious/inauspicious moments) for starting or doing or disregarding any activity (both agricultural as well as non-agricultural). For example: For finding out auspicious moments/days for ploughing of farmlands, astrologers consider the “*Hala Chakra*” or “*Ploughing Cycle*”. According to the cycle, the three *nakshatras* ahead of the *nakshatra* the sun leaves are inauspicious; three *nakshatras* ahead of those are auspicious; next three are inauspicious; next five are auspicious; next three are inauspicious; next five are auspicious; next three are inauspicious; and last three *nakshatras* are auspicious. This completes the cycle of 28 *nakshatras* (Ref: *Muhurta Jyotish Vigyan*; and *Muhurta Chintaman*). In addition to the above, the “*Beejopti Chakra*” or “*Seed Cycle*” should also be considered. According to the cycle, eight *nakshatras* from the *nakshatra* at the position of the sun are inauspicious; in successive order next three *nakshatras*

are auspicious; the next (one) *nakshatra* is inauspicious; next three *nakshatras* are auspicious; next (one) *nakshatra* is inauspicious; next three *nakshatras* are auspicious; next one *nakshatra* is inauspicious; next three *nakshatras* are auspicious; and last four *nakshatras* are inauspicious (Ref.: *Brihat Jyotish Sara*; and *Muhurta Jyotish Vigyana*). Three ‘*Uttaras*’—(*Uttarashadha*, *Uttaraphalguni*, and *Uttarabhadrapada*), *Hasta*, *Chitra*, *Swati*, *Mula*, *Dhanishtha*. *Rohini*, *Mrigashira*, *Pushya*, *Anuradha*, *Ashwini*, and *Magha* are auspicious for crop transplanting and animal trade. Except *Magha* and *Hasta*, all other *nakshatras* are auspicious for irrigation (Ref.: *Mururta Chintamani*).

(iii) **Panchang-making** - The content and coverage of the proposed *Krishi-Panchang* indicate that only qualified astrologers cannot prepare the whole content on their own, rather an editorial board comprising of both qualified astrologers and crop specialists can do justice. While preparing the *Panchang*, the editorial board members should keep in mind the following important points:

- The *Krishi-Panchang* is largely meant for the local farming communities, having very low educational status. Hence, it must be in the local colloquial language to facilitate reading and comprehension.
- Care should be taken to make the *Krishi-Panchang* easily understandable and clear in its meaning.
- It should be very comprehensive in its content and coverage with proven predictive information only.
- It should not contain any astrological details or complexities, which would go beyond the understanding capability of our less educated farmers and agriculturists.
- It should be attractive in colour, and presentation of information should be systematic according to seasons (*Kharif*, *rabi*, and summer) and crops.
- It must be low-priced/nominal-priced, within the affordable range of small and marginal farmers.
- More important is, it must be made available to the farmers and needy persons sufficiently in advance, *i.e.*, at least 1–2 months before the start of the agriculture year (July-June).

2.7 METHODS OF RAINFALL FORECASTS

Rainfall forecast is defined as “to tell before hand when, where and how it would rain”. For thousands of years India has been using astrology, study of clouds, examination of winds, observations of nature, animals, plants, birds for medium and short-range forecasts after the examination of the trends of rain astrologically for its overall long range forecasts.

Short range forecasts are forecasting monsoon rainfall developments, a few hours to 48 hours or 72 hours ahead.

Medium range forecasts are “preparation of scatter diagrams showing dispersal of rainfall classified as abnormal or normal or sub normal during the five-day period subsequent to the period to which the pressure height of a pair of selected stations refer”.

Long range forecasts are issued twice in the year for the entire period of four months June to September and later for the second half of the monsoon season August and September.

A. Artificial Rain-making Versus Yagna

Artificial rain making is the technique of making the already existing cloud cause rain. The ancient Indian Vedic yagna technique is also used to cause rain. In the ‘Yagna’, the ash gases released through

the burning of certain combinations of wood and other materials during the yagna could result in ice-nucleating hygroscopic particulate matter. In the yagna experiment, the ash from the ingredients were claimed to have similar properties as the common salt used in seeding. Scientists do not believe seeding can be done without the presence of cloud first in that lies their difference with the yagna experiments where it is claimed clouds are first formed and then seeded by nuclei in the ash. (In USA, Red-Indians do rain-making dances and bishops to sprinkle water on fields).

Chemical cloud-seeding is a process for artificial rain-making destroying hail or making fog disappear. The cloud seeding is done with the spray of sodium chloride or silver iodide over the clouds through aero plane. Chemical cloud-seeding is of two-types-warm clouding and cold clouding. Warm clouding is done in tropical country while cold cloud-seeding is done in hills such as Kerala. For cloud seeding, there must be a good cloud with a thickness of at least one kilometer. The clouds contain hygroscopic nuclei (water-vapour attracting particles) but the smaller nuclei travel faster than bigger ones. If bigger nuclei are introduced in the cloud, they will absorb the smaller nuclei already present. The process of seeding is to “excite” the bigger nuclei already present and make them to grow at a higher speed so that they drop down as droplets of rain.

In *warm seeding*, which is a process of coagulation, the cloud is seeded by common salt (NaCl) along with soapstone powder to prevent coagulation. The common salt nuclei are bigger than big nuclei and are hygroscopic in nature so they start precipitation and increase the efficiency of precipitation in a cloud from the usual 10 percent to a much higher count. The increase is compared with control cloud and the growth can be observed through radar.

In *cold-seeding* by a sublimating process, the cold cloud is already at a temperature below 0° C. Even in that state there are two nuclei, one in the ice state and the other in the water state at different pressures. The water nucleus, which is at higher pressure, goes over the ice nucleus. So here ice nucleus is introduced by seeding with silver iodide in a liquid state.

2.8 CROPS

Indian agriculture is one of the oldest in the world and has millennia with involvement of farmers who have domesticated introduced and genetically enhanced a large number of species to harness maximum productivity. Farmers have preserved seeds along with associated knowledge over generations leading to conservation. Archaeological findings have revealed that rice was a domesticated crop grown along the banks of the Ganges in the sixth millennium B.C. Later, it extended to other areas. Several species of winter cereals *viz.*, barley, oats and wheat and legumes such as Lentil and chickpea domesticated in Southwest Asia, were grown in Northwest India before the sixth millennium B.C. Some other millets, such as sorghum, pearl millet and finger millet which were earlier domesticated in Africa, found their way to the Indian subcontinent more than 4000 years ago. In addition, smaller millets such as the species of *Panicum*, *Setaria*, *Echinochloa*, and *Paspalum* were domesticated in India since the Neolithic period. Archaeological research also revealed cultivation of several other crops 3000 to 6000 years ago. These include oil seeds such as sesame, linseed, safflower, mustards and castor; legumes such as mung bean, black gram, horse gram, pigeon pea, field pea, grass pea (khesari) and fenugreek; fibre crop such as cotton (*Gossypium spp.*) and fruits such as jujube, grape, date, jackfruit, mango, mulberry and black plum. Animals including livestock, sheep, goats, asses, dogs, pigs and horses were also domesticated. The primitive communities of the Neoliths period domesticated plants for food, legumes tubers fruits fibres and luxury crops. A classification of the crops cultivated in the early parts of human history has been given in Table 2.8.

Table 2.7. Categories of Crops Cultivated during the Prehistoric Period

<i>Food crops</i>	<i>Legumes</i>	<i>Roots/Tubers</i>	<i>Fruit</i>	<i>Fibres</i>	<i>Luxury</i>
Wheat	Peas	Turnips	Nuts	Flax	Cocoa
Barley	Beans	Carrots	Apples	Cotton	Tea
Rice	Lentils	Garlic	Figs	Hemp	Opium
Maize	–	Potatoes	Oranges	–	Tobacco
Millet	–	–	Dates	–	–

2.9 ORIGIN OF CROP PLANTS

Russian biogeographer Vavilov's (1949) classification of origin and approximate dates for the most common domestic plants (Table 2.9).

Domestication of plants and animals or the origin of agriculture is quite recent in the annals of mankind. The more recent investigations show that agriculture began around 10000 years BP (before present) or 8000 B.C. during the Sumerian times in south-west Asia.

Table 2.8. Classification of Plant Species and Origin

<i>Plants Species</i>	<i>Region of origin</i>	<i>Date in thousand years BP (BP = before present)</i>
Emmer wheat	Near East (Southwest Asia)	9-10
Einkorn Wheat	Near East (Southwest Asia)	9.5-8.5
Barley	Near East (Southwest Asia)	9.5-8.5
Pea	Near East (Southwest Asia)	9.5-8.5
Lentil	Near East (Southwest Asia)	9.5-8.5
Vetch	Near East (Southwest Asia)	9.5-8.5
Flax	Near East (Southwest Asia)	9.5-8.5
Naked wheat	Near East (Southwest Asia)	9.5-8.5
Rice	Southeast Asia	7-5
Sugarcane	Southeast Asia	7-5
Sorghum and mulberry	North China	Korea and Japan
Soybean	North China	7-5
Almond, walnut, melon	Central Asia	6-5
Olive, fig, vine	Mediterranean Europe	6-5
Sorghum and cotton	Africa	6-5
Cucurbit	Tropical America	9-8
Capsicum, maize (corn)	Tropical America	8.5-7.5
Common bean, cotton, arrow-root, groundnut, tomato	Tropical America	7.7
Lima bean	Tropical America	7.7

A. Indigenous Crops (Nene, 2002)

Archaeological findings have revealed that rice (*Oryza sativa* L.) was a domesticated crop grown along the banks of the Ganges in the sixth millennium B.C. Later, it extended to other areas. Several species of winter cereals (Barley (*Hordeum vulgare* L.), oats (*Avena sativa* L.), and wheat (*Triticum aestivum* L.) and legumes-lentil (*Lens culinaris* M.) and chickpea (*Cicer arietinum* L.) domesticated in South-west Asia, were grown in North-west India before the sixth millennium B.C. Some other millets, such as sorghum (*Sorghum bicolor* (L.) Moench.) pearl millet (*Pennisetum glaucum* (L.) R. Br. and finger millet (*Eleusine coracana*, (L.) Gaertn.) which were earlier domesticated in Africa, found their way to the Indian subcontinent more than 4000 years ago. In addition, smaller millets such as the species of Panicum, Setaria, Echinochloa, and Paspalum were domesticated in India since the Neolithic period. Archaeological research also revealed cultivation of several other crops 3000 to 6000 years ago. These include oil seeds such as sesame (*Sesamum indicum* L.), linseed (*Linum usitatissimum* L.), safflower (*Carthamus tinctorius* L.), mustard (*Brassica spp.*) and castor (*Ricinus communis* L.); legumes such as mung bean (*Vigna radiata* L.), black gram (*Vigna mungo* L. Hepper), horse gram (*Dolichos biflorus* L.), pigeonpea (*Cajanus Cajan* (L.) Millsp.), field pea (*Pisum sativum* L.), grass pea (*Lathyrus sativus* L.; khesari) and fenugreek (*Trigonella foenumgraecum* L.), fibre crop such as cotton (*Gossypium spp.*) and fruits such as jujube (*Ziziphus mauritiana* Lam.) grape (*Vitis vinifera* L.), date (*Phoenix sylvestris* Roxb.), jackfruit, mango (*Mangifera indica* L.), mulberry (*Morus alba* L.) and black plum (*Syzgium cuminii* L. Skeels). Animals, including livestock, sheep, goats, asses, dogs, pigs and horses were also domesticated (Mehra, 1997). Early indigenous domesticates: Rice was identified from several sites dated earlier than 1500 B.C. from the Gangetic region. Vavilov (1928) listed 117 economic plants which were domesticated in the Indian center or origin/diversity of crop plants.

B. Origin of Cultivated Plants**1. Indian Main Center** includes Assam and Burma

Cereals and Legumes	<ol style="list-style-type: none"> 1. Rice, <i>Oryza sativa</i> 2. Chickpea or gram, <i>Cicer arietinum</i> 3. Pigeon pea, <i>Cajanus indicus</i> 4. Urd bean, <i>Phaseolus mungo</i> 5. Mung bean <i>Phaseolus aureus</i> 6. Rice bean <i>Phaseolus calcaratus</i> 7. Cowpea, <i>Vigna sinensis</i>
Vegetables and Tubers	<ol style="list-style-type: none"> 1. Eggplant, <i>Solanum melogena</i> 2. Cucumber, <i>Cucumis sativus</i> 3. Radish, <i>Raphanus caudatus</i> 4. Taro <i>Colocasia antiquorum</i> 5. Tamarind, <i>Tamarindus Indica</i>
Fruits	<ol style="list-style-type: none"> 1. Mango <i>Mangifere indica</i> 2. Orange <i>Citrus sinensis</i> 3. Tangerine, <i>Citrus medica</i> 4. Citron <i>Citrus medica</i> 5. Tamarind <i>Tamarindus indica</i>

(Contd.)

Sugar, Oil and Fiber plants	<ol style="list-style-type: none"> 1. Sugar cane, <i>Saccharum officinarum</i> 2. Coconut palm <i>Cocos nucifera</i> 3. Sesame <i>Sesamum indicum</i> 4. Safflower <i>Carthamus tinctorius</i> 5. Tree cotton <i>Gossypium arboreum</i> 6. Oriental cotton <i>Gossypium arboreum</i> 7. Jute, <i>Corchorus capsularis</i> 8. Crotalaria, <i>Crotalaria juncea</i> 9. Kenaf, <i>Hibiscus cannabinus</i>
Spices, Stimulants, Dyes, and Miscellaneous	<ol style="list-style-type: none"> 1. Hemp, <i>Cannabis indica</i> 2. Black pepper <i>Piper nigrum</i> 3. Gum arabic, <i>Acacia arabica</i> 4. Sandalwood, <i>Santalum album</i> 5. Indigo, <i>Indigofera tinctoria</i> 6. Cinnamon tree, <i>Cinnamomum zeylanticum</i> 7. Croton, <i>Croton tiglium</i> 8. Bamboo, <i>Bambusa tulda</i>

2. **Indo-Malayan Center** includes Indo-china and the Indo-Malay Archipelago

Cereals and legumes	<ol style="list-style-type: none"> 1. Jobs tears, <i>Coix lacryma</i> 2. Velvet bean, <i>Mucuna utilis</i>
Fruits	<ol style="list-style-type: none"> 1. Pummelo, <i>Citrus grandis</i> 2. Banana <i>Musa Cavendishii</i>, <i>M. Paradisiaca</i> <i>M. sapientum</i> 3. Breadfruit, <i>Artocarpus communis</i> 4. Mangosteen, <i>Garainia mangostana</i>
Oil, sugar, spice, and fiber plants	<ol style="list-style-type: none"> 1. Candlenut, <i>Aleurites moluccana</i> 2. Coconut Palm <i>Cocos nucifera</i> 3. Clove, <i>Caryophyllus aromaticus</i> 4. Nutmeg, <i>Myistica fragrans</i> 5. Black pepper, <i>Piper nigrum</i> 6. Manila hemp or abaca <i>Musa textilis</i>

3. **Central Asiatic Center** includes North-west India (Punjab, North-west Frontier Provinces and Kashmir) and Afghanistan

Grains and legumes	<ol style="list-style-type: none"> 1. Common wheat, <i>Triticum vulgare</i> 2. Clup wheat, <i>Tricticum compactum</i> 3. Shot wheat <i>Triticum sphaerocoecum</i> 4. Lentil, <i>Lens esculenta</i> 5. Horse bean, <i>Vicia faba</i>
---------------------------	--

	6. Chickpea <i>Cicer arietinum</i> 7. Mung bean, <i>Phaseolous aureus</i> 8. Mustard, <i>Brassica junca</i> 9. Flax <i>Linum usitatissimum</i> (One of the centers) 10. Sesame, <i>Sesamum indicum</i>
Fiber plants	1. Hemp, <i>Cannabis indica</i> 2. Cotton, <i>Gossypium herbaceum</i>
Vegetables	1. Onion, <i>Allium cepa</i> 2. Garlic, <i>Allium sativum</i> 3. Spinach, <i>Spinacia oleracea</i> 4. Carrot, <i>Daucus carota</i>
Fruits	1. Pistacia, <i>Pistacia very</i> 2. Pere, <i>Pyrus communtis</i> . 3. Almond, <i>Amygdalus communis</i> 4. Grape, <i>Vitis vinifera</i> 5. Apple, <i>Malus pumila</i>

C. Introduced or Exotic Crops

Portuguese introduced new crops and fruit plants during the sixteenth century and enriched the agriculture of India. They were the greatest benefactors of India. Babar introduced the scented Persian rose. Similarly the botanical garden of Calcutta has performed a very useful function by introducing many important new plants. Following are some of the crops and plants, which were introduced by Portuguese from Brazil, Chile, Peru and Mexico. These crops and trees now form important components of the common cropping systems followed in the country.

Crops introduced by Britishers

Pseudo cereals	Oats
Grain legumes	Pea
Fiber crops	<i>Gossypium barbadense</i> (cotton)
Vegetables	Leek, Asparagus sp., <i>Beta vulgaris</i> (beet root), Cauliflower, Brussels sprout, Knol-khol, Celery, Sweet pepper, Chicory, Squash, <i>Daucas carota</i> (carrot, orange type), Lettuce, Tomato, Sweet pea.
Fruits	Bilimbi, Carambola, Papaya, Rose apple, Strawberry, Mangosteen, <i>Helianthus tuberosus</i> (artichoke), Tapioca (cassava), Apple, Apricot, Cherry, Plum, Peach, Pear.
Medicinal and aromatic plants	<i>Cinchona officinalis</i> (quinine), <i>Origanum vulgare</i> (marjoram), <i>Cinchona officinalis</i> (quinine), <i>Origanum vulgare</i> (marjoram), <i>Papaver somniferum</i> (opium poppy), <i>Pelargonium capitatum</i> (Geranium), <i>Salvia officinalis</i> (sage), <i>Thymus vulgaris</i> (thyme), <i>Vanilla aromatica</i> (vanilla).
Others	<i>Casuarina equisetifolia</i> (Casuarina), Coffee, <i>Eucalyptus globulus</i> (Tasmanian blue gum), <i>Grevillea robusta</i> (silver oak), <i>Hibiscus rosasinensis</i> (shoe flower), <i>Lantana odorata</i> (Lantana), <i>Magnolia grandiflora</i> (Bull Bay), Myrtle, Horse bean, Parsnip, Avocado, Pine trees, <i>Poinciana regia</i> (Peacock flower), Mahogany, Cacao (cocoa).

Crops introduced from West and Central Asia by Mughals or Arabs - Onion, Garlic, Turnip, Cabbage, Coriander, Sweet muskmelon, Carrot, (black & red type), Date palm, Pea, Clover and Grape.

Crops introduced by Spaniards: *Phaseolus vulgaris* (French bean).

Crops introduced from China: Soybean, Loquat, Walnut, Litchi.

Crops introduced from Latin America: Rubber, Pineapple.

Crops introduced from South-east Asia and Pacific islands: Sugar-palm, Breadfruit, *Citrus decumanus* (pomelo), *Citrus paradisi* (grapefruit), *Durio zibethinus* (durian) and *Metroxylon sagus* (sago).

Some recent introductions

Mentha arvensis (spearmint, USA) *Acacia senegal* (Australia),

Acacia mangium (Australia) and *Actinidia chinensis* (Kiwifruit, New Zealand).

Crops introduced by Portuguese: Groundnut, Tobacco, Potato and Agave.

Tobacco was introduced during the reign of Emperor Akbar. It seems that they first introduced it into Goa and then into Bijapur. The potato (*Solanum tuberosum*), a native of highlands of Chile and Peru, was introduced into India by the Portuguese in the seventeenth century. The first mention of potato in India occurs in Terry's account of a banquet given by Asaf Khan to Sir Thomas Roe in A.D 1615 at Ajmer. Portuguese introduced agave (*Agave Americana*) or the century-plant, which has now become naturalized throughout India. Its panicles of white flowers are highly ornamental, and its sword-like leaves protect our gradients.

2.10 HISTORY OF RICE

Rice was grown in China nearly 5000 years ago. Remains of rice were found in the Yung Shao excavations in China, dating as far back as 2600 B.C. According to one writer, Julien, it was reserved for the Emperor of China to sow seed of rice at a particular ceremony (established about 2800 B.C.) in the beginning of the cultivation season, and the sowing of the less important kinds of grain was relegated to the princes of his family. Archaeological excavation dated to 2300 B.C. at Lothal in Gujarat, a southward extension of the Harappa and Mohen-jo-daro culture indicated the rice cultivation. Do Condoile, affirms that rice had been a valued crop in India since Vedic times, though its cultivation in that sub continent might not be of the same antiquity as that of China. The archaeological rice sample from India was from carbonized grains excavated from Hastinapur, north to Delhi and from Atrajnjikera in Uttar Pradesh had revealed that rice was cultivated from 1500 to 700 B.C. One of the Indian names of rice dhanya, for instance, means the supporter and nursery of mankind. Dhanya means 'sustainer of the human race' which indicates its age-old importance. Various ceremonies in India include the use of dhanya and the kernel tandula since it is regarded as an emblem of wealth, fortune, and prosperity. Rice is a symbol of fertility and as such as originally used in China to pelt newly wed couples in order to bring them good luck and assure them of many children. The Sanskrit word Urihi which most writers accept as the most direct name for the grain in that language finds mention in Atharveda (1100 B.C.). It may be interesting to note that the name of rice kernel is 'arisi' in Tamil language and the Arabian name for it is alruzz, in the Spanish it is called arroz. What says that the Arabic word al-ruzz is not derived from the Tamil word (from which some people argue that the word rice is derived) but from the Greek word Aruza the name for rice. The famous Ayurvedic Doctor Susuta (1000 B.C.) mentions in his "materia medica" different groups of rice based on duration, water requirements and nutritional values,

recommended for particular ailments. The names of some of the ancient kings of India were derived from or associated with the word rice, thus about the sixth century B.C., the King of Nepal, father of Gautama Buddha, was known as Suddhodana, which means 'pure rice'. The Sanskrit word for wild rice 'neevara' is also used in Telegu language for the wild rice, which invades the fields and waterways. Rice spread eastward from India to China and then to Japan and westward into Iran, Iraq, Turkestan and Egypt. According to Green historians, Alexander the Great (about 300 B.C.) carried rice from India Europe and it went from there to Egypt and other countries in Africa. Large scale cultivation in Europe did not however begin till the close of the seventh century A.D. Because of the unsuitability of natural conditions available there. From India rice went to Persia, Arabia and Turkestan where its cultivation is still primitive, as they do not possess the right conditions for its culture.

2.11 HISTORY OF WHEAT CULTIVATION

Although wheat was introduced long before the Christian era, it attained its importance only after it. It was the chief food of the 'mlechcha' (non-believers in God), "the barbarians", perhaps the Greeks and the people living outside India, and received the name 'mlechcha-Bhojana' (food for the non-believers). It was for a long time known as 'Yavana' a kind of barley. A Greek writer has also mentioned about wheat. Parasara, in *Krishi-samgraha*, speaks of wheat being a winter crop.

2.12 HISTORY OF SUGARCANE CULTIVATION

Sugarcane was cultivated in India since prehistoric times and was an important crop there by the end of the fourth century B.C. The Rig Vedic Aryans had the cane, and possibly the family name Ikshaku, had connection with large plantation. Apparently the cane was mostly chewed only and sometimes pressed and the juice used as drink. The idea of drying up the juice over fire came later, and the earliest known product was 'gula', or 'guda', a ball. In Bengal it is known as 'bheri' or 'bheli', from its form resembling a kettle-drum. There was no attempt at crystallization. In course of time the next stage came, when crystals were allowed to form, culminating in the production of 'sitopala', white crystals like rock crystals. A thoroughly scientific classification of the products of manufacture will be found in our medical works. It is also interesting to note that while only two varieties were known to Charaka, the number had increased to twelve by the time Susruta came. Among the latter's twelve there was one called 'tapasa', evidently the wild ancestor of the modern forms. It is a remarkable fact that there is still a variety of cane known as 'Uri akh' in the north-west of Bengal which flowers freely, and the cultivators use the seed for propagation, the adjective, 'uri' meaning wild, as in 'Uridhan'. One of the twelve varieties of Susruta was 'paundraka', or 'paundra', the same as 'paunda' and 'punri' of our cultivators, undoubtedly the best of the indigenous canes. The commentators of *Amarakosha* tell us that the variety is so named because it grew in the country called Punara, or Northern Bengal. It seems the country derived its name from this fact just as the name Gauda from 'guda'. The people who cultivated the cane were known as Paundras. During the invasion of India (327 B.C.) Alexander's army found the local people obtaining 'honey' from reeds without the aid of bees. The methods of growing cane and making sugar diffused east to Indo-china and west to Arabian countries and Europe. Kautilya noticed that the cultivation of sugarcane involves trouble and expense. The difficulty was overcome by co-operation. The cultivators formed a 'grantha' or 'knot' or club among themselves both for the purpose of cultivation and manufacture of sugar. Co-operation was resorted to whenever the individual peasants were unable to meet the wants separately. It is known as 'ganta' in Bengali, and is not at all a new idea recently introduced. The share-produce system of cultivation so common in our country is a form of

co-operation. The name sugar is derived from the Sanskrit word 'Sarkara', meaning gravel or sand. The earliest crude sugar made from the juice of the sugarcane was like sand. The original name was changed during its journey, to 'Sukkar' in Arabic, 'Sakharon' in Greek, Sucre in French and finally to sugar in English. The next major event in the history of sugarcane was the importation of thick stemmed varieties of *Saccharum officinarum* from Thhiti to Jamaica in 1791 by Captain Bligh.

2.13 HISTORY OF COTTON CULTIVATION

Gossypium herbaceum var. africanum may be regarded as a wild ancestor of the domesticated plants. The development of cotton textiles appears to have taken place, not in Africa, but in the Indus valley in what is now Pakistan. Trade routes were opened between Africa and India at that time, and linted cotton may well have been introduced to India as a curiosity, used first as a trimming or for embroidery on linen and woollen fabrics. The earliest known cotton fabrics in the Old World belong to the Indus civilization, indicating that the development of cotton as major new raw material took place in Sind. Excavations in Mohen-jo-daro, Sind, Pakistan (Indus Valley) by Gulati and Turner (1928) revealed that occurrence of cotton in the form of strings and fragment of cloth covering the household articles, which archaeologists date to about 3000 B.C. The fragments discovered at Mohen-jo-daro were evidently made by competent craftsmen, and not by people experimenting clumsily with a new art, or with an unfamiliar raw material. In all hair characteristics that could be measured, the Mohen-jo-daro cotton was within the range of Indian cotton of the present day so it is certain that the major changes involved in the evolution of lint were complete at that time. The existence of cotton threads has also been mentioned in the Rig Veda the oldest scripture of the Hindus, written about 1500 B.C. and repeated references of cotton utilization have been recorded in the 'The sacred institute of Manu' and 'Asvalayana' (800 B.C.). From India, cotton was introduced eastward to China and Westward to Egypt around A.D. 600 but it was probably not cultivated there as a field crop for textile purposes until the thirteenth or fourteenth century. Arab traders introduced cotton cultivation to the rest of African continent. It was brought to southern Europe (Sicily and Spain) by the Arab conquerors in the ninth and tenth centuries A.D. The Greek and Roman civilizations depended largely on flax wool and silk. The inventions of the automatic power loom by Edmund Cartwright in 1785 in England and the cotton gin by Eli Whitney in 1793 in America revolutionized the cotton industry. Throughout the nineteenth century, cotton production expanded steadily and now it is cultivated in all tropical, subtropical and warm temperature parts of the world. Wool, silk and flax were used for spinning and weaving long before cotton became important. Purseglove (1960, 1963) suggested that *Gossypium herbaceum* could have reached South America in Tertiary times via the Antarctic, retreating northward as glaciation advanced. Fryxell (1965) showed that cotton seeds can survive floating in sea water for at least a year with undiminished viability and can thus be distributed by ocean currents. Purseglove (1968) agree that the most likely explanations were that cottonseeds floated across the Atlantic from Africa to South America.

2.14 CROP PRODUCTION IN ANCIENT INDIA

The most probably earlier cultivation of crops was started on the foothills of upland areas of easily worked soil and not in the valleys because development of agriculture in the valley implies water control which need more skill and relatively more advance stage of technological development. This hypothesis about the beginning of agriculture in the forested foothills was put forward by Sauer - the American biographer. Sauer (1952), in his hypothesis about the origin and development of agriculture, propounded that:

- Agriculture did not originate in communities desperately in short supply of food, but among communities where there was sufficiency of food resulting into relative freedom from want and needed.
- The hearths of domestication are to be sought in regions of marked diversity of Plants and animals.
- The primitive agriculture did not origin in the large river valleys, subject to the lengthy floods and requiring protective dams, drainage or irrigation, but in moist hill lands.
- The agriculture began in forested lands, which had soft soil easy to dig.
- The pioneers of agriculture had previously required special skills but the hunters would be least inclined towards the domestication of plants.
- The founders of agriculture were sedentary folks, because growing of crops requires constant attention and supervision and unless guarded properly, the crop will be lost.

Raising of crops was an important vocation even in the pre-Vedic period and it put an end to nomadic life. Animal husbandry was dominant and crop raising was combined with livestock and trees. The economy of the country, according to Patanjali, depended upon agriculture and cattle breeding. Farmers of the Vedic period possessed a fair knowledge about soil fertility, selection of seeds, seasons of sowing and harvesting and other practices including manuring of fields. In 'Arthashastra' there is mention about the suitability of different lands for cultivation of crops. Farmers of the Vedic period knew the methods of improving soil fertility through rotation of crops. They planted deep rooting plants, which served as natural aerators. Sweet potato was used to loosen the soil for the next crop. The swelling roots of the crop acted like mild explosives. As an incentive to the farmer, sweet potato was included in the diet specified for fasts, which indirectly helped in creating consumer demand for the crop. Most common rotations were of three years, which included deep rooted, shallow rooted and legume plants. These were wheat-chick pea; sugarcane-green manure crop; wheat-fallow; pigeon pea, sorghum, etc. Mixed farming which included a combination of crops and livestock components was already in practice. Mixed cropping was the accepted system for raising crops. Legumes such as chickpea and other pulses were often grown in combination with wheat in order to augment the nitrogen availability for wheat. Some of the important crop mixtures were sorghum + pigeon pea + cowpea; black gram or green gram (Mung bean) + sorghum or bajra; wheat + chickpea; and wheat + linseed. In general, monocropping was not the accepted practice.

2.14.1 Seasons

Six seasons mentioned in Rigveda are *viz.*, Grishma (May-June), Varsha (July-August), Hemant (September-October), Sharad (November-December), Shishir (January-February) and Vasanta (March-April). The seasons in temperate climate are given below:

<i>Winter</i>	<i>Spring</i>	<i>Summer</i>	<i>Autumn</i>
January	April	July	October
February	May	August	November
March	June	September	December

2.15 PLANTING TIME AND SELECTION OF LAND FOR DIFFERENT CROPS (KASYAPA)

The planting should be commenced with the beginning of the rainy season in several countries. Kashyapa has mentioned taking a crop even in summer if water was available. He divided arable lands into two major categories; *viz.*, lands suitable for growing rice (paddy) and lands suitable for other crops. Basically low-lying lands, which could be irrigated easily, were meant for rice, whereas the uplands where water supply was limited were meant for the crops such as pulses. Rice fields were to be of higher fertility than fields under other crops and were to be bunded to retain water but the bunds had to give openings to allow excess water to flow elsewhere. Rice soils were to be clayey and rice fields close to each other and to the threshing ground. Rice fields were always to have standing water. Kashyapa stated that fields for pulses, etc., were to be highlands and were considered of second quality. These crops needed less water.

2.16 LAND PREPARATION

In Rigveda, farmers are stated to have resorted to repeated ploughings of land before sowing seeds. Clearly the purpose of such ploughings must have been to remove weeds, loosen the soil and pulverize it to the extent required. Excavations made at Kalibangan, Rajasthan (India) revealed a ploughed field (2450–2300 B.C.) that showed a grid of furrows, with North-South furrows 1.9 m apart and East-West furrows 30 cm apart. This pattern probably indicates the practice of mixed cropping. Practice of incorporating sesame as green manure before land preparation has already been mentioned in Varha Mihira's *Brhat Samhita*. There is a reference to heavy and light ploughs in Vedic literature. These were probably used for deep or shallow ploughing as required. Sage Parasara had stated that Anila *i.e.*, Swati, Uttarashadha, Uttarabhardrapada, Uttarpahalguni, Rohini, Mrigashirsha (Mriga), Mula, Punarvasu, Pushya, Shravana and Hasta are good stars for ploughing. Plowing on Monday, Wednesday, Thursday and Friday results in good growth of crops. The second, third, fifth, seventh, tenth, eleventh, and thirteenth, day of the month are good for ploughing. Ploughing should be commenced on auspicious lagnas, such as Taurus (April 21), Pisces (February 20), Virgo (August 22), Gemini (May 21), Sagittarius (November 23) and Scorpio (October 23). Lagna is the moment of the Sun's entrance into the respective regions. Furrows should be single or in groups of three to five. Single furrows lead to success, in threes to wealth, and those in five yield plenty of harvest. One plough gold in Hamanta (December-January), silver and copper in Vasanta (April-May) only crops in summer (June-July), but in rainy season (August-September) one can plough only poverty.

2.17 SOIL AS A BASIC RESOURCE FOR SUCCESSFUL CROP PRODUCTION (KASHYAPA)

Kashyapa divided the agricultural land into two categories: shalibhu (=land fit for rice cultivation) and adhakadibhu (=land suitable for cultivation of pulses and other grains). A good quality land yields good results to everyone, confers good health on the entire family, and causes growth of money, cattle and grain. Thus the importance of a good soil can never be overemphasized. Kashyapa states that it is the responsibility of the king to appoint knowledgeable persons, regardless of their caste affiliation, to scrutinize the suitability of land for growing crops. Kashyapa points out that a good soil should be devoid of bones and stones, should be a plastic clay with reddish and black hue, full of essence (potency), and glossy with water, should not be too deep or shallow, should be conducive to speedy

seedlings emergence, should be easily absorb moisture and should be inhabited with beneficial living creatures (earthworms) and should have a substantial mass. Kashyapa states that the soil may possess Brahaminic qualities, qualities of Kshatriyas, as also those of Vaisyas and Sudra. Using traits normally associated with these castes, one could conjecture that a soil should be fertile and give stable yields; a soil should give yields by controlling enemies such as pests, a soil should give sometimes, bumper yields, and a soil should give good yield when looked after with close attention respectively.

2.18 THE PLOUGH AND OTHER IMPLEMENTS

Parasara provides information on construction details of the plough—a version called the desi plough ‘wooden plough’ as well as reference to a few other implements such as an abadha (disc plough) phalika (leaf shaped iron piece to replace the normal iron blade for deep ploughing), Viddhaka (spike tooth harrow with 21 spikes), and madika (wooden plant for levelling the field were provided. The use of a disc 54 angulas in diameter (approx. 1 m) in place of ploughshare for using on hard virgin soil is recommended. The dates for ploughing operation are suggested on 20, February; 21, April; 21, May; 22, August; 23, October and 23, November. A calendar for ploughing for taking the crops was only mentioned in Krishi–Parashara.

<i>Starting of ploughing</i>	<i>Crops</i>
20, February	Sugarcane, black gram
21, April	Rice (to be transplanted later)
21, May	Rice (to be directly seeded) and other warm season crops such as cotton and sesame
23, October	Late sown wheat and barley plus mustard
23, November	Field vacated by rice for planting sugarcane and fodder crops.

Kashyapa has specially indicated that use of strong wood for various purposes (*e.g.*, making a tying post) such as tinduka (*Diospyros melanoxylon*), tinisha (*Ougeinia oojeinensis*) or a sarjaka (*Vateria indica*). Manure should be available and used for increasing the ‘potency’ of the land. Besides plow, spades, lancets, small horns, (for breaking soils crust) knife, sickles, ropes, etc., were mentioned. Ploughing was to begin with the visibility of rain-bearing clouds and plots were to be filled with water for puddling to prepare for planting paddy. Kashyapa refers to worship of plough as well as bullocks.

Farm implements - Ancient literature of the subcontinent did not miss out on farm implements. Vedas describe a simple bullock drawn wooden plough, both light and heavy with an iron bar attached as a plough share to open the soil. Krishi Parashara (c. 400 B.C.) (Sadhale, 1999) gives details of the design of the plough with Sanskrit names for different parts. This basic design has hardly undergone any change over centuries. Even today the resource poor farmers use a similar bullock drawn plough. A bamboo stick of a specific size was used to measure land. Vedic literature and Krishi Parashara also mention disc plough seed drill, blade harrow (Bakhar), wooden spike, root harrow, plankers, axe, hoe, sickle, supa for winnowing, and a vessel to measure grain (udara). Pairs of bullocks used for ploughing in ancient days varied from one to eight. Plough was considered as the most sacred and essential implement in agricultural operations and was known by different names. The more commonly known desi plough was a multipurpose implement.

2.19 SEED COLLECTION AND PRESERVATION

Sage Parasara: All sorts of seeds should be procured in Magha (February) or Phalguna (March) and should then be dried well in the sun without putting those directly on the ground. To procure healthy seeds of panicles are located in the field, cut from the standing crop, and collected in a pouch. A mixture of different kinds of seeds causes great loss. Uniform seeds produce excellent results. *The origin of plentiful yield is the seed.*

Kashyapa: A good quality of seed is stated to be the first step towards the success in farming. Seeds of several trees specified for plantation are also to be procured and preserved. Seeds of wheat, pulses, fruits, vegetables and condiments such as turmeric, cumin, black pepper, etc., also need to be preserved for cultivation in the proper season. Kashyapa describes the procedure of preserving the seeds and advises farmers to dry the seeds in the sun, store them in different kinds of vessels, and protect them from stormy rains and moisture as well as from rats, cats, and rabbits.

2.20 CROP DIVERSITY

India had a large and wide diversity in cereals, millets, pulses, oil seeds, fibres, vegetables and fruits. The species and varietal diversity provided wide choices for selection according to soil type, climate and management practice. A variety of rice, which was ready for harvest in sixty days, was available in ancient India. Magadha grew another variety with large grains of extraordinary fragrance which was called rice of grandes. Manasollasa referred to eight varieties of rice distinguished by their colour, odor, size and period of growth. India had five wild species of rice from which there had been a regular trend of evolution from perennial to annual habit, from cross pollination to self-pollination and from lesser to greater fecundity. Wheat recovered from Mohen-jo-daro belonged to *Triticum vulgare*, *T. compactum* and *T. sphaerococum*. *T. sphaerococum* is a wheat of great antiquity (2300 B.C.) and was widely grown in north India. It has high resistance to drought. Barley was cultivated throughout the Harappans period. Aryans were accustomed to barley diet. They adopted wheat and barley in the Indus valley culture and generated new variability required for intensive cultivation. Millets such as sorghum, bajra and ragi were also important. They were primarily grown for grain but the straw was also regarded valuable as a cattle feed. About 25 species of sorghum were known to have been available. The use of ragi (*Eleusine coracana*) straw as a cattle feed was noticed in 1800 B.C. Pulses figured predominantly in crop rotations and crop mixtures in the early period. Being legumes they maintained and improved fertility of the soil. Lentil, black gram, green gram and Lathyrus (Khesari) are pulses of antiquity and were noticed in Narmada basin during 1657-1443 B.C. India is the original home of green gram. A wild variety of *Vigna sublobata* was found in Tarai forests. It was immune to yellow mosaic virus and was used in plant breeding. Black gram was widely accepted as a nutritious pulse crop in the ancient Indian culture since the Vedic period. It was used in socio religious ceremonies and even today its importance has not waned. Similarly lentil also enriched the traditional diet. In oil seeds, sesamum was the most important crop grown by Harappans in the Indus valley. The *Brassica* group covering brown mustard, yellow mustard and thoria is collectively known as Indian rape. The other important oil seeds comprised linseed and castor. Cotton cultivation was known to Harappans. Wild and weedy types of cotton have been recorded from Gujarat, Kathiawar and Deccan. They are perennial and known as tree cotton. Harappans also knew date palm, pomegranate, lemon, coconut and melon. Babar (before 16th century) mentioned in his memoirs the plants he saw in India. They were mango, plantain, tamarind, mahuwa, jamun, chironji, khirni, karonda, ber, anola and orange. It is obvious that the earlier people possessed a good knowledge of crops. The strategy for the selection of crops and the adoption of different

cropping and farming systems was decided on the basis of resources available with the individual and his immediate and long term needs. Through a continuous process of selection and elimination, promising plants or varieties were identified and their multiplication brought about by adopting diligent methods of seed collection, preservation and exchange within the social groups.

2.21 CHOICE OF CROPS AND VARIETIES

Kashyapa listed rice and other cereals as the first, pulses and other grains as the second vegetables (including fruits) the third, and creepers and flowers etc., the fourth. Kashyapa considered three main varieties of rice, Shali, Kalama, and Shastika. Shali rice is said to have twenty six varieties depending on the quality of land in different regions. Kalama is slightly thick white, and with a surplus sap. Shastika is tasteless. Vrihi is considered to be oldest name for rice. Shukla vrihi (white rice) mentioned in Krishna Yajurveda (300 B.C.). In the same Veda Krishnanam vrihini (black rice), asunam vrihinam (fast growing, 60 day rice), mahavrihinam (large seeded rice) and naivaram (wild rice) have been mentioned. Atharvaveda, naivaram became nivara and in addition to black rice, red rice, and the 60-day rice were mentioned. A new name for rice appeared in the Atharvaveda; *i.e.*, tandula (for dehusked rice). The word vrihi for rice was used in Upanishads. Shali was used for those rices, which were planted at the beginning of the rainy season and harvested in winter; these were probably the 6 month varieties. Vrihi, Shali, Nivara, Shastika as well as a new word Kalama appeared in Susruta Samhita (400 B.C.) and Amarkosha of Amarsinha (200 A.D.).

2.22 RICE VARIETIES—OTHER ASPECTS

Some of the other highlights under the topic collection and preservation of seed are: (i) it is the king's government in today's context (responsibility to ensure seed supply), (ii) seed must be properly dried in sun, (iii) giving a gift of seed is a superior act, (iv) different varieties of rice mature at different times taking 3 to 8 months, (v) farmers should respect traditional knowledge of the region and use it, (vi) Seeds of all kinds of other crops should be likewise collected, dried, and stored in pots, heaps, of husk or bowls and (vii) seeds must be protected from rabbits, rats, cats, and moisture. Taking care of good seeds religiously is conducive to the benefit of farmers (as has been) said by great sages.

Basmati Rice: The word 'basmati' has its origin in the Sanskrit words 'vaas' means fragrance and 'matup' means possessing. Thus vaasmati should mean something possessing fragrance in northern India, 'va' is often pronounced as 'ba' and thus the word 'basmati' should have been used for a kind of rice having fragrance of scent.

Golden rice: Kashyapa had claimed that Peetvarna vrihi (yellow rice) improved digestion or a sambaka variety called Hema (golden rice).

2.23 SEQUENCE OF CROPPING

In the Yajurveda, distinct references to the rotation of crops are found. Crops were grown in the same field by rotation and the system of fallowing was also known (Rigveda). The Taittiriya Samhita distinctly mentions that in the *course* of a year, two crops were harvested from the same field. It also mentions different seasons for ripening of different crops and the proper times for harvesting them. In a descriptive passage of the Ramayana sali, godhuma and yava are seen waiting for harvest with the advent of winter. But wheat and barley are winter or *rabi* crops sown in October and gathered at the end of May. Kautilya gives directions for seasonable cultivation and harvesting. The Arthashastra evinces not only thorough acquaintance with these two harvests but even with a third. A king is instructed to march

against his enemy in Margasirsa (January) in order to destroy his rainy crops and autumnal handfals, in Caitra (March) to destroy autumnal crops and vernal handfals, and in Jyesthamula (June) to kill vernal crops and rainy season handfals. Thus there were three crops—one sown in rainy season and garnered before Magha, another sown in autumn and garnered before Caitra and a third sown in spring and stored by Jyaistha (cf. Barley “ripened in summer being sown in winter, rice ripened in autumn being sown in the rains, while beans and sesamum ripened in winter and the cool season”). Arthasastra catalogues the crops of different seasons. Paddy, kodruva, sesamum, panic, daraka and varaka are sown in the first season (purvavapah), mudga, masa and saivya are sown in the second season (madhyavapah), kusumbha, lentil, kuluttha, barley, wheat, kalaya, linseed and mustard are sown in the last season. The Artha sastra agree with *kharif* and *rabi*-crops respectively. The Milinda speaks as well of a third monsoon-(pavllssako) besides the regular rains of the later Summer and early winter. The three monsoons of course did not uniformly visit every part of the country each year; and whether a locality grew one or two or three crops depended on-rainfall, climatic conditions and character of the soil. In many places the food crops as well as edible fruits and vegetables grew spontaneously without tillage. To the Greek observers these phenomena seemed strange. The description of the forest scenery in the Epics (Ramayana; Mahabharata) and the Jatakas frequently go at length over the crops and fruits growing in wild areas without human labour. In Arthasastra, it is stated that raising of a second crop by the cultivators was sometimes made compulsory as a last resource for taxation. After a careful observation of the meteorological charts, it suggests the quantity of rain required by a specific crop and the cultivator is instructed for the particular crop along the rain forests.

Crop rotation in Rigveda: Continuous cropping was a practice, but pulses (legumes) and other crops were also sown. “The cultivators harvesting the crops in general, separately and in due order” has been interpreted to be giving an idea of crop-sequence or crop-rotation and line-sowing and avoiding overlapping during harvest.

2.24 SEED AND SOWING

Ancient scholars showed awareness of the importance of good seed; *i.e.*, selection of the apparently healthy seed from a ripening crop, preserving it safely in storage, with or without treatments and sowing the good seed again with or without some treatment. About 2000 years ago, Parashara recommended (i) proper drying of seed, (ii) freedom from the seeds of weeds, (iii) visual seed uniformity, (iv) storing seeds in strong bags, and (v) storing seed where white ants would not have access and at a location where seed would not come in contact with substrates that would allow moulds to grow such as cowshed wastes, damp spots, or left over foods. Sage Parasara had stated that Uttrashadha, Uttarashadha, Uttarabhardrapada, Uttarpahalguni, Mula, Jeyshtha, Anuratha, Magha, Rohini, Mrigashirsha (Mriga), Rohini, Hasta, and Revathi are the good nakshatras for sowing. Two days should be avoided for sowing, transplanting; Tuesday, which portends threat from rats and Saturday, which foretells threat from locusts and insects. Sowing should not be done on ‘empty’ days (such as the fourth, ninth, and the fourteenth day of the lunar fortnight of a month) especially if the moon is weak. Seeds of grains should be planted at a distance of hand (approximately 1½ ft =45 cm) when the sun is in Cancer. In Leo the distance should be half of it. In Virgo it should be four fingers, (3–4 inches =7.6 –10.2 cm). Butter milk makes the seeds sprout earlier than the normal time. Salt would kill the embryo. Kautilya in Artha Sastra indicated that decision to sow seeds of specific crops should be taken on the basis of known rainfall patterns. He recommended that rice be sown first and mung bean and black gram later. He also suggested some seed treatments. (*e.g.*, cow dung, honey and ghee) to ensure good germination. Manu mentioned that a professional farmer (the Vysya) must be able to determine the quality of seed. The

most significant recommendation by Manu was severe punishment to a trader selling spurious seed. Kashyapa's procedure of sowing involves ploughing, levelling, furrowing, or digging pits. The procedure is said to depend on the characteristics of land, availability of water, sunshine, and also on additional wisdom. Varahamihira recommended pelleting of seed with flours of rice, black gram and sesame and fumigating them with turmeric powder to ensure good germination. Surapala listed several botanicals such as seed treatment materials for shrubs and trees. Even today cow dung, suggested by Kautilya in the 4th century B.C., is used for treating cotton and some other seeds by a large number of farmers. Sowing of seed was considered a very important event. Prayers and rituals were associated with the sowing operation. Primitive bamboo drills were used for sowing seed. Adjusting the inter-plant and inter-row spacing was done on the basis of sowing time; late sowing meant more seeds per unit area. A wooden plank was run over sown fields to ensure uniform seed germination. The art of sowing rice in small areas; *i.e.*, in nurseries and transplanting of the seedlings is not a recent practice. It was first perfected in the deltas of Godavari and Krishna rivers in 100 A.D.

The general practice of sowing seeds, according to Varahamihira, involved soaking them in milk for ten days, taking out daily with hand, smearing with ghee, rolling many times in cow dung and fumigating with the flesh of deer or hog. Then the seeds were sown in a soil which was already treated with sesamum crushed together with flesh and hog's marrow. They grew and bloomed when sprinkled with milk and water. Another method was to soak the seeds hundred times in a paste of Ankola (*Alangium salvifolium* Wang) fruit in its oil or in a paste or oil of Slesmataka (*Cordiarothii* Roem and Schult) fruit and sow in a soil mixed with hail. The seeds would sprout instantly and bear fruits. Hard seeds like tamarind sprouted when sprinkled with a mixture of the flour of rice, black gram and sesamum and wheat particles together with stale meat, and fumigated with turmeric powder, repeatedly. For Slesmataka the shell of the seeds was removed, then soaked in water, mixed with the paste of *Alangium* fruits and dried in the shade seven times, mixed with buffalo dung and stored in the dry dung. The seeds were then sown in a soil soaked with rain water. The bearing was good.

Seeds were treated in a special manner to get special results. Cotton seed was treated with red lac juice in a special manner to get red tinged cotton. It was also treated with cow dung paste to facilitate sowing and control of seed borne diseases. The seedlings for transplanting at a distant place were smeared from root up to the stem with a mixture of ghee, Usira or Khas (*Vetiveria zizanioides*), sesamum, honey, Vidanga (*Embllica ribes*), milk and cow-dung. Sali paddy was grown by transplanting (Kalidas in Raghuvamsha). Incidentally, the technique of transplanting rice was widely practice in Krishna-Godavari deltas in 100 A.D. It was the most important agricultural operation during the Sangam age (A.D. 300–600). Varahamihira has recorded two methods of grafting. They are: (i) inserting the cutting of a plant into the root of another, cut off from its trunk, and (ii) inserting the cutting of a tree into the stem of another. The junction of the two in both the cases was covered with a coating of mud and cow dung. Grafting was advocated for jackfruit, ashoka, plantain, rose apple, lemon, pomegranate, grape, jasmine, etc. Further, he recommended February-March for grafting those plants which have not developed branching; December-January for those which have developed branching and August-September for those which have developed large branches. The grafted trees were to be watered both in the morning and evening every day in summer, on alternate days in the cold season and whenever the soil becomes dry in the rainy season.

Kashyapa's view on rice cultivation: Rice is divided by experts into three main varieties based on their taste and colour; shali, kalama and shastika. The golden rice sambaka vrihi (rice) var hema and peetavarna vrihi (yellow rice), which removes indigestion. Kalama of red colour, kalama of thick form,

kalama of long form, vrihi (rice) of sambaka variety called hema (golden). Kala vrihi (sweet and nourishing rice), sit vrihi (white rice) and peetavarna vrihi (yellow rice), which removes indigestion. Kashyapa's procedure of rice cultivation starts with plowing, maintaining standing water, planting of seedlings, weeding, water management, crop protection, harvesting at the proper time, pounding on the threshing floor, cleaning and storing in the house. *Kashyapa for the first time has recommended transplanting of rice in ancient literature.*

2.25 WEEDS AND WEEDING

The role of weeds in reducing crop yields was well understood by our ancestors. Parashara pointed out the need to weed rice fields; as many as four weedings were suggested. Weeding as an essential practice in raising crops is stated in the Sangam literature. Parashara recommends collection of crop seeds free of weed seeds.

2.26 NUTRIENT MANAGEMENT

Kashyapa emphasized that the Brahmins proficient in Vedas should sprinkle the fivefold cow-products (milk, curd, ghee [clarified butter], urine, and dung) or may be simply sprinkle with clean water over the land (for the purpose of purifying the atmosphere) either in the morning or in the evening. This is known as 'Panchakowia'.

2.27 WATER MANAGEMENT

Sage Parasara: Construction of bunds to retain water in plots is recommended to rice. Bunding has not been recommended in low-level fields since there would be adequate moisture. Direct seeding of rice has been recommended for low-lying areas. Avoid flooding of rice once the panicles have come out, however the soil must remain moist.

Kashyapa was supportive of irrigated crop production: Kashyapa focused his attention on irrigated agriculture. Construction of wells and device for lifting water had been described. Kashyapa has given details about where how water reservoirs should be constructed. He stressed construction of a reservoir near farmers' fields, ensuring source of water for the reservoir, making strong causeways and thus taking steps to avoid flooding of inhabited areas, and regularly inspecting and repairing the reservoirs, especially during the rainy season. The last one is good reminder to present day, lazy, and indifferent staff of the government irrigation departments. Each farmer should have access to two reservoirs. Kashyapa's recommendations on buildings and maintenance of reservoirs are technically sound. Kashyapa recommended planting of trees around water reservoirs obviously to protect and beautify them. He suggested picnic spots around reservoirs, a feature that is considered 'modern' in the 21st century. Construction of canals has been indicated in verses 111 through 143 of section I. Kashyapa has mentioned four sources of canal. (i) river, (ii) tank, which could have been filled by a river, (iii) large lake, and (iv) canals collecting water from mountain cascades. Kashyapa has stressed provision of a proper gradient for the canals and a network of these canals surrounding villages. He emphasized selection of soil with right structure and profile for making canals and avoiding saline soils. Protection of the canal system, like the protection of reservoirs was also stressed. Kashyapa recommended construction of wells, especially in areas where canal water was not available. Best time for digging wells was the post rainy season. He suggested study of indicators for the presence of sub soil water such as existence of trees and course, water

divining. He stressed laying strong foundation with bricks and building walls with bricks and mortar. Even provision of steps to enter a well was recommended. Kasyapa has mentioned the use of ghatyantra (the so-called Persian wheel) with the help of bullocks, elephants, and humans. Harvesting of rain was stressed. A verse that says everything about water for farming is “it may be a canal, a well, a pool, or a lake, but find they must and acquire a guaranteed source of water.”

2.28 NEW CROPS AND OTHER PLANTS

Portuguese introduced new crops and fruit plants during the sixteenth century and enriched the agriculture of India. They were the greatest benefactors of India. Babar introduced the scented Persian rose. Similarly the botanical garden of Calcutta has performed a very useful function by introducing many important new plants. Following are some of the crops and plants which were introduced by Portuguese from Brazil, Chile, Peru and Mexico. These crops and trees now form important components of the common cropping systems followed in the country.

(a) Crops

- Groundnut (Peanut) - main source of edible oil in India. A native of Brazil.
- Tobacco - introduced by Portuguese during the reign of Emperor Akbar.
- Potato - widely accepted and grown in India as a favourite vegetable. It is a native of Chile and Peru.
- Amaranth - the colourful crop is grown along the whole length of Himalayas. It is a native of Brazil.
- Chillies - the ornament of Indian garden and soul of pickles. It is a native of Brazil and Peru.
- Agave - a century plant and has become acclimatized throughout India.
- Allamanda (*Allamanda cathartica* L. Mant) - a climber with beautiful flowers. It is a native of Brazil and South America.

(b) Fruits

- Cashew nut - widely grown in India and a native of Brazil.
- Guava - common fruit crop of India. It grows wild in Brazil.
- Custard apple - widely grown as a forest crop. Introduced by Portuguese.
- Sapota - a gift from Portuguese. Delicious fruit and native of Mexico.
- Pineapple - extensively grown in eastern parts of India. It is indigenous to Brazil. Indian people evinced keen interest in the introduced crops and gave a fair trial under close observation. This resulted in the spread of the selected crops throughout India.

2.29 GROWTH PROMOTERS

In respect of diseases, Varahamihira says the tree catches disease from cold weather, strong winds and hot sun. In such cases a paste made of vidanga, ghee and silt must be applied to the affected parts. Water and milk should be sprinkled on such trees. When there is a premature fruit drop, the tree should be watered with milk that has been cooled after being boiled with horse gram, black gram, green gram, sesamum and barley. After this treatment, the trees will produce abundant flowers and fruits. A mixture of powdered dung of goats and sheep, sesamum powder, wheat articles, beef and water, kept for seven nights should be sprinkled for increasing flowers and fruits of trees, creepers and shrubs. In the Sangam age, the dung of cow and sheep and green leaves were used to increase the yield of crops. Krishi

Parashara has prescribed the method of preparing manure from cattle dung and dry leaves. Sesamum, cow dung, barley powder, fish and water when mixed in fixed proportions formed an effective manure. According to Varahamihira, sesamum is sown and ploughed back when it blooms in order to mix it with the soil. Cow dung, dung of buffaloes, goats and sheep, clarified butter, sesamum, honey, horse gram, black gram, green gram, barley, roots of certain plants, ashes, stale meat, beef and marrow of hog were used as manure. The Indus valley produced surplus food. All important cities had large storage facilities for stocking grains. The rulers at that time had the wisdom of maintaining buffer stocks. One of the granaries stored enough barley to provide wages for 400 days. Another granary had the capacity to pay in kind for 10,930 man days. Trade was by barter and payment to labourer was in kind. The artisans, carpenters and others received their wages in kind from the farmers.

Agriculture without supervision was considered fruitless. The owner of the field was to look after the field himself. If he failed to supervise the agricultural operations, the belief was that the Goddess of prosperity would desert him and in her place adversity would enter his field. According to Arthashastra, if any farmer was found negligent in his duties of carrying on the agricultural operations in time, the King had the right to snatch away the land from him and hand it over to another man of the village. The foremost duty of the King was to protect agriculture and render assistance to the farmers. These directions show that the concept of management was known and practiced by everybody including the King.

2.30 HARVESTING AND MEASURING YIELDS

Sage Parasara: Aardra, Kritika, Chitra, Pushya, Hasta, Swati, Uttarashadha, Uttarabhadrapada, Uttaraphalguni, Mula, and Shravana are the nakshatras recommended for the token harvest. Harvest should not be done on 'empty' days. The fourth, ninth, and the fourteenth days of the lunar fortnight are Rikta or empty days. Grains should be measured from left to right and not the other way. Adhaka is a wooden vessel used to measure gains roughly equivalent to 7 lb and 12 oz (about 3.5 kg). It is equal to one fourth drona. Measuring the grains from the right leads to expenditure whereas from the left leads to happiness and enhancement of yield.

Measurement of crop produce (Kashyapa): He should also make arrangements of prastha, kunjja, drona, and small nadika for (proper) measurement of grains of cereals and adhaka (pigeonpea) etc., and other commodities. The first three are the measures of capacity, prastha = $\frac{1}{4}$ adhaka; drona = 4 adhakas, kunjja—should have been kunchi = $\frac{1}{32}$ adhaka, where one adhaka = 256 fistfuls = 32 kunchis, *i.e.*, 32 handfuls, nadika is a measure of length = 2 hastas, where one hasta is the distance between the elbow and the tip of the middle finger and is approximately equal to 18 inches. Pala (a weight of gold = 4 karshas = 64 mashas = 640 grain of masha (black gram).

2.31 STORAGE OF GRAINS

Sage Parasara: The auspicious Meena (Pisces) lagna (February) is the best for storing grains. Hasta, Sharavana, Dhanishtha, Shatabhishita, Pushya, Bharani, Uttarashadha, Uttarabharapada, Uttaraphalguni, Mula, and Magha are the auspicious nakshatras for storing grains. Monday, Thursday, Friday, and Saturday should of course be avoided.

2.32 FARMING SYSTEMS

The importance attached to food quantity in Anna Sukta shows that arable farming was given equal importance as stock farming. The praise of land, bullocks, seeds and peasants in various hymns clearly

indicates importance attached to arable farming, crop husbandry with different types of field grasses for food and fodder being considered for the dual purpose of man and animal. The traditional land use and occupational structures in Indian agriculture have invariably been site-specific based on available resources and sound ecology. In India for example people of Rajasthan developed nomadic and animals care based occupation because the land fragile and could not be used intensively. The people of Mizoram and Nagaland developed shifting cultivation as their system of survival because they had to live on slopes and this was the best way to sustain their soil fertility and productivity and conserve and use the bio-resources in sustainable manner. This highly organized agro-ecosystem called Jhum is based on empirical knowledge accumulated over centuries. It functions in harmony with environment and provides enough time for recovered of forest and soil fertility that is lost during cropping phase. It involves slashing of vegetation burning it before the on set of monsoon raising mixture of crops on temporarily enriched soil for a year or two leaving it fallow for a few needs fresh system like Zabo system a combination of forestry soil and water conservation, Alder system for soil health and Panikheti system of wet rice cultivation with judicious use of water have been developed. Shifting agriculture practiced in India has mixed cropping as a standard feature. It was once conceded primitive by scientists, however now it is being suggested as a means to increase world food production. During the cropping phase the farmers raise 8–35 crops species on a small plot of 2 to 2.5 ha with simultaneous sowing and sequential harvesting the crop mixture provides crop cover against loss of nutrients, optimisms resources facilitates recycling of biomass and nutrients and improves soil characteristics.

Zabo farming system is practiced in Nagaland. ‘Zabo’ means impounding of water. The system is a combination of agriculture, forestry, livestock, fishery and soil and water conservation. The Zabo system comprises protected forest land on the top of the hill, well planned rainwater harvesting tank on the top of the hill and indigenous methods of nutrient management in hill region, cattle yard and terraced rice fields towards foothills. The Soils of the area are salty clay loam in texture with grayish brown colors and there are no means of irrigation. Animal manure is the major source of crop nutrition. The silt deposited in the tanks is dug out during off-season and added to the fields. This silt is very rich in nutrients as it contains lot of forest litter. Farmers also add leaves and succulent branches to the fields and leave for decomposition. This helps in building up soil fertility and maintenance of soil health. This indigenous farming system is good example of integrated use of land, water and nutrient. Shifting cultivation, which otherwise causes soil and nutrients loss, the Zabo method of cultivation is ecofriendly, takes care of natural resources and soil erosion is negligible.

Shifting agriculture practiced in India, which has mixed cropping as a standard feature. It was once conceded primitive by scientists, however now it is being suggested as a means to increase world food production. During the cropping phase the farmers raise 8–35 crops species on a small plot of 2 to 2.5 ha with simultaneous sowing and sequential harvesting the crop mixture provides crop cover against loss of nutrients, optimisms resources facilitates recycling of biomass and nutrients and improves soil characteristics. The people of Mizoram and Nagaland developed shifting cultivation as their system of survival because they had to live on slopes and this was the best way to sustain their soil fertility and productivity and conserve and use the bio-resources in sustainable manner. This highly organized agro-ecosystem called Jhum cultivation is based on empirical knowledge accumulated over centuries. It functions in harmony with environment and provides enough time for recovered of forest and soil fertility that is lost during cropping phase. It involves slashing of vegetation burning it before the on set of monsoon raising mixture of crops on temporarily enriched soil for a year or two leaving it fallow for a few needs fresh system like Zabo system a combination of forestry soil and water conservation.

Farms yield gold if properly managed but lead to poverty if neglected. Only the capable (people are) to undertake farming for the welfare of people. An incapable farmer lands himself in poverty. An

agriculturalist who looks after the welfare of his cattle, visits his farms, daily has the knowledge of the seasons, is careful about the seeds, and is industrious is rewarded with the harvest of all kinds and never perishes. Farms should be never left to the care of anyone other than oneself. Kashyapa has recommended *cooperative farming* too for the first time. He also advises the farmers to take up second cultivation every year. This is said to be particularly beneficial on a fertile land with sufficient water supply throughout the year.

2.33 SOIL CLASSIFICATION

Physically, India may be divided more or less into three main regions *viz.*, (1) the mountainous borders of Himalayas in the north and of the Vindhya in the south with the linings of Ghats in the south-eastern and south-western coasts and the traverse range or Aravalli hills; (2) the Deccan plateau or table land; and (3) the plains or low-lands, a rich Indo-Gangetic alluvium overflown by the rivers—the Ganges, Jamuna and Brahmaputra. Although primordial mountains remained inaccessible for human settlement, the foothills have been increasingly brought under cultivation and settlement and the upland valleys striking the Himalayas include some of the most fertile of Indian lowland formations. The whole Indo-Gangetic alluvium consists of rich fertile *soil* and has contributed materially to the growth of civilization.

- (i) **The Himalayas** - The Himalayas (Sanskrit: hima, 'snow' and alaya, 'abode'), the loftiest mountain system in the world, form the northern limit of India. This great, geologically young mountain arc is about 1,550 miles (2,500 km) long, stretching from the peak of Nanga Parbat in Pakistan-held Jammu and Kashmir to the Namcha Barwa peak in the Tibet Autonomous Region of China. Between these extremes the mountains fall across India, southern Tibet, Nepal, and Bhutan. The width of the system varies between 125 and 250 miles.
- (ii) **The Indo-Gangetic Plain** - The second great structural component of India, the Indo-Gangetic Plain (also called the North Indian Plain), lies between the Himalayas and the Deccan. The plain occupies the Himalayan fore deep, formerly a seabed but now filled with river-borne alluvium to depths of up to 6,000 feet. The plain stretches from the Pakistani provinces of Sind and Punjab in the west, where it is watered by the Indus and its tributaries, eastward to the Brahmaputra valley in Assam. The Ganges basin (mainly in Uttar Pradesh and Bihar) forms the central and principal part of this plain. The eastern part is made up of the combined delta of the Ganges and Brahmaputra rivers, which, though mainly in Bangladesh, also occupies a part of the adjacent Indian state of West Bengal. This deltaic area is characterized by annual flooding attributed to intense monsoon rainfall, an exceedingly gentle gradient, and an enormous discharge that the alluvium-choked rivers cannot contain within their channels. The Indus River basin, extending west from Delhi, forms the western part of the plain; the Indian portion is mainly in the states of Haryana and Punjab. The Great Indian, or Thar, Desert, forms an important southern extension of the Indo-Gangetic Plain. It is mostly in India but also extends into Pakistan and is mainly an area of gently undulating terrain, and within it are several areas dominated by shifting sand dunes and numerous isolated hills.
- (iii) **The Deccan Plateau** - The remainder of India is designated, not altogether accurately, as either the Deccan Plateau or peninsular India. It is actually a topographically variegated region that extends well beyond the peninsula—that portion of the country lying between the Arabian Sea and the Bay of Bengal—and includes a substantial area to the north of the Vindhya range, which has popularly been regarded as the divide between Hindustan (northern India) and the Deccan (Sanskrit: daksina, "south").

Agriculturists in ancient India were quite conscious of the nature of soil and its relation to the production of a specific crop of economic importance. The vast knowledge acquired by experience has been handed over from generation to generation.

2.34 SOIL TYPES OF INDIA

The investigations of Voelcker in 1893, and those of Leather in 1898, led to a classification of India soils into four major types and three minor types: (i) the Indo-Gangetic alluvium; (ii) the black cotton soils; (iii) the red soils lying on metamorphic rocks; and (iv) the lateritic soils.

- (i) **Indo-Gangetic alluvium** - The Indo-Gangetic alluvium is by far the largest and most important of the soil groups of India. The soils of this group cover about 777,000 square kilometers. They are distributed mainly in the Punjab, Haryana, Uttar Pradesh, Bihar, Bengal and parts of Assam and Orissa. They produce bumper crops of wheat and rice. Geologically the alluvium is divided into: (i) *Khadar*, or new alluvium of sandy composition, generally light in colour, about 10,000 years old, and (ii) *Bhangar*, or the older alluvium of Pleistocene date, of more clayey composition, generally of dark colour, and full of pebbles or *kankar*. The soils differ in consistency from drift sand to loams, and from fine silts to stilted clays. A few pebble beds are also occasionally met with. The presence of impervious clays obstructs the drainage, and also promotes the accumulation of injurious salts of sodium and magnesium, which make the soils sterile. The formation of hard pans at certain levels in the soil profile as a result of the binding of soil grains by the infiltrating silica or calcareous matter is often observed in these alluvial soils. A majority of the soils are loams or sandy loams, with a soil crust of varying depth. Soluble salts are present in considerable quantities.

The alluvial soils of Tamil Nadu are transported soils, found mainly in the deltaic areas and on the coastal line. A section of the profile shows alternate layers of sand and silt. The composition of the strata varies with the nature of the silt brought by the rivers which, in turn, varies with the catchment areas and the tracts through which the streams flow.

- (ii) **Black cotton soils** - The typical soil of the Deccan Trap is the *regur* or black cotton soil. It is common in Maharashtra, in the western parts of Madhya Pradesh, Karnataka, and some parts of Tamil Nadu, including the districts of Ramnath and Tirunelveli in the extreme south. It is comparable with the chernozems of Russia and with the prairie soil of the cotton-growing tracts of the United States of America, especially the black adobe of California. It is derived from two types of rocks: the Deccan and Rajmahal Trap, and the ferruginous gneisses and schists occurring in Tamil Nadu under semi-arid conditions. The former attains sometimes considerable depths, whereas the latter are generally shallow. The black soil areas have, generally, a high degree of fertility, though some mainly in the uplands are of low productivity. The soils on the slopes and the uplands are somewhat sandy, but those in the broken country between the hills and the plains are darker, deeper and richer, and are constantly enriched by deposits washed down from the hills.
- (iii) **Red soils** - Red soils extend practically over the whole Archaean basement of Peninsular India, from Bundelkhand to the extreme south, covering 2,072,000 square km, embracing south Bengal, Orissa, parts of Madhya Pradesh, eastern Andhra Pradesh, Karnataka, and a major part of Tamil Nadu. These soils also occur in Santhal Parganas in Bihar, and in the Mirzapur, Jhansi and Hamirpur districts of Uttar Pradesh. They were produced as a result of meteoric weathering of

ancient crystalline and metamorphic rocks. These soils started developing around the Mesozoic and Tertiary ages. The colour of these soils is generally red, grading sometimes into brown chocolate, yellow; grey and even black. The redness is due more to a general diffusion than to a high proportion of iron content. The soils grade from the poor thin gravelly and light coloured varieties of the uplands to the much more fertile deep dark varieties of the plains and the valleys. They are generally; poor in nitrogen phosphorus and humus. Compared with regur, they are poor in lime, potash and iron oxide, and are also uniformly low in phosphorus. The clay fraction of the soils is rich in kaolinite. More than two-thirds of the cultivated area in Tamil Nadu is covered by red soils they are in-situ formations produced from the rock below under the influence of climatic conditions. The rocks are acidic, consisting of mica or red granites. The soils are shallow and open in texture. They have a low exchange capacity and are deficient in organic matter and plant nutrients.

- (iv) **Laterites** - Laterite is a soil type peculiar to India and some other tropical countries, characterized by the intermittent occurrence of moist climate. In formation it varies from compact to vesicular rock composed essentially of a mixture of hydrated oxides of aluminium and iron with small quantities of manganese oxides, titanium, etc. It is produced by the atmospheric weathering of several types of rocks. Laterites occur in Madhya Pradesh, the coastal region of Orissa, south Maharashtra, Malabar and part of Assam. All lateritic soils are generally very poor in lime and magnesia and deficient in nitrogen. Occasionally, the P_2O_5 content may be high, but there is deficient of K_2O . In Tamil Nadu, there are both high-level and low-level laterites which are formed from a variety of rock materials under certain climatic and weather conditions. The laterites at lower elevations grow rice whereas those at higher elevations grow tea, cinchona, rubber and coffee. The soils are rich in nutrients and contain 10 to 20 per cent organic matter.
- (v) **Forest and hill soils** - The soil formation is governed mainly by the character of the deposition of organic matter derived from the forest growth. Broadly, two conditions of soil formation may be distinguished: (i) soils formed under acid condition, with acid humus and low base status, and (ii) soils formed under slightly acid or neutral condition with high base status, which is favourable to the formation of brown earths. Forest and Hill soils occur in Assam and in Uttar Pradesh, the Sub Himalayan tract comprises three distinct parts *viz.*, *bhabar* area immediately below the hills, *tarai* and the plains. The *tarai* areas are characterized by extreme unhealthiness owing to excessive soil moisture and prolific growth of vegetation. The soils in Coorg has deep surface soil of great fertility, as it receives annually the decomposed products of the virgin forest. The areas towards the west are for the greater part reserved under forests and mountain areas. The land surface is full of pebbles, is easily drained, and has a laterite bed.
- (vi) **Desert soils** - A large part of the arid region of Rajasthan and the Punjab and Haryana, lying between the Sutlej and the Aravallis, is affected by desert conditions, which geologically are of recent origin. This part is covered under a mantle of blown sand, and is dominated by conditions, which inhibit soil growth. Some of the soils contain a high percentage of soluble salts and varying percentages of calcium carbonate, and possess high pH. They are, however, poor in organic matter. Reclamation is possible only if proper irrigation facilities are made available.
- (vii) **Saline and alkaline soils** - These soils are extensively distributed throughout India in all the climatic zones. These soils occur in Bihar, Uttar Pradesh, Punjab, Haryana and Rajasthan. The injurious salts are confined to the top layers, being deposited there by the capillary *transference of saline solutions from the lower strata. It has been estimated that nearly 850,000 hectares in Uttar Pradesh and over 200,000 hectares in the Punjab and Haryana have been affected by usar.*

Over 10,000 hectares are being affected every year in the Punjab and Haryana. Alkali soils are met with all over Maharashtra.

2.35 MAINTENANCE OF SOIL PRODUCTIVITY

A. Manures

Importance of manures in obtaining high crops yields was fully appreciated in ancient India. In Krishi-Parashara, it is stated that crops grown without manure will not give yield and a method of preparing manure from cow dung is described. Kautilya mentioned use of cow dung, animal bones, fishes, and milk as manure. Agnipurana recommends application of the excreta of sheep and goat and pulverized barley and sesame allowed to be soaked in meat and water for seven nights to increase flowering and fruiting of trees. In Varahamihira's *Brhat Samhita* growing of sesame to flowering stage and then incorporating it as green manure is recommended. The *Abhilasitarthacintamani* mentions a few such fertilizers—(1) The soil underneath a tree struck by lightning is good for warding off trouble for trees from snowfall. (2) Fumigation of trees by burning turmeric, Vidanga, white mustard, flowers of the Arjuna tree, mixed with fish and the flesh Rohita (a kind of deer) will not only help the growth of flowers and fruits but will destroy all worms and insects as well as diseases. Surapala (c. 1000 A.D.) describes the 'ancient' practice of preparing liquid manure (kunapa) prepared by boiling a mixture of animal excreta, bone marrow, flesh, and dead fish in an iron pot and then adding to it sesame oil cake, honey, soaked black gram, and a little ghee (or clarified butter). No fixed quantities of materials were required to prepare 'kunapa'. This liquid manure was mainly used in raising trees and shrubs. Traditional agriculture practiced in the Himalayas regions of the sub continent involves use of green leaf manure as the main fertilizer for the rice crop. Surapala and Sarangadhara recommended the use of kunapa for properly nourishing trees. The preparation of kunapa is described by Sarangadhara as follows: "One should boil the flesh, fat and marrow of deer, pig, fish, sheep, goat, and rhinoceros in water and when it is properly boiled one should put the mixture in an earthen pot and add into the compound milk, powders of sesame oil cake, masa (black gram) boiled in honey, the decoction of pulses, ghee, and hot water. There is no fixity as to the amount of any of these elements; when the said pot is put in a warm place for about a fortnight, the compound becomes what is called kunapa water which is very nutritious for plants in general". Prior to Sarangadhara, Surapala had referred to kunapa and ingredients included excreta, bone marrow, flesh, brain, and blood of boar mixed with water and stored underground. Surapala also referred to "available" materials and these could be animal fat, marrow, and the flesh of fish, ram, goat, and other homed animals. Other materials were more or less the same as mentioned by Sarangadhara, except that quantities of ghee and honey indicated were small. It should not be difficult to standardize and prepare kunapa water concentrates on mass scale and make these available in jars to users. Here is an opportunity for an enterprise to help farmers, especially the orchardists. Firminger (1864) who was a "Chaplain of the Bengal Establishment" mentions beneficial use of "liquid manure", prepared the way Kunapa was prepared, for vegetable cultivation. He has given no information about who first thought of liquid manure".

B. Green Leaf Manures

Farmers relied extensively on crop residues legumes and neem for enriching the soil fertility. Ancient Tamil texts, widely quoted the use of *Calotropis gigantea*, *Morinda tinctoria*, *Thespesia populnea*, *Jatropha gossypifolia* and *Adathoda sp.*, to be used as green leaf manure. Crop rotation and intercropping were practiced to restore soil fertility. Fauna such as ants, earthworms and frogs were used to improve

soil physical properties. Composting practices have also been documented in ancient literature on ideal farming practices. The farmers of Tamil Nadu manure the soil with farmyard manure (FYM), oil cakes, compost and green manures or green leaf manures is an age-old practice.

C. Recycling

Recycling of nutrients through pond excavation was achieved through tank silt or pond excavation in the foothill zones. The sediments from ponds coming from open spaces, field, etc., during the monsoon. The sewage slurry and dissolved minerals and nutrients in water coming from animal sheds and household washings are also diverted to the common village pond. All the flocculated clay and organic materials usually settle quickly to give clear water of the pond. Animals used to drink water from this pond. As soon as the ponds dry up in summer season, the farmers dig the pond base by lifting the soil and transport it to the fields. The surface layer of pond base usually removed is about 30 cm depth. This is a rich source of plant nutrients. The application of pond sludge to each field is done once in a span of 10–15 years. Tank silt increases clay content in light textured red soils, which helps to increase soil moisture content and finally the crop yield. In Coimbatore and Trichy districts, farmers apply tank silt to crops like banana, turmeric and jasmine where as in Ramanathapuram farmers apply it to rice @ 25 t/ha. The excavation of pond basin and its application to field was abandoned with the introduction of chemical fertilizers. Farmers excavate ‘murrum’ a uppermost weathered basalt rock and apply to the fields.

D. Compost

The compost becomes ready to use in five to six months. This partially decomposed farmyard manure after spreading evenly in the field is worked into the soil by ploughing followed by planking.

<i>Crop straw</i>	<i>Grain to straw ratio</i>
Rice	1:1:5
Pearl millet	1:2:0
Maize	1:1:5
Cotton	1:6:0
Wheat	1:1:5
Barley	1:1:5
Mustard	1:2:0
Pulses	1:1:0
Sugarcane	1:0:2

E. Penning

Penning of sheep, goat, cattle and pig in the fallow fields is common. One or two fields by rotation are kept fallow to receive the animal dung and urine during summer as well as winter months. Large herds of sheep, goat and cattle are kept in the fallow fields. The farmers used to feel obliged and usually come with a request to cattle herd owners for the night stays at their farm land. The litters of sheep get well mixed with soil during the period of penning. Light cultivation before the onset of monsoon makes it more effective. Sheep feed on the existing farm residue and drops litter in the same field during resting period. The excreta of sheep is acidic in reaction. On each piece of land, penning is continued for 2 to 4 days depending on the size of the flocks to gather or accumulate sufficient manure to improve the fertility status of the soil.

F. Rishi–Krishi Method of Vermiculture

The Amrit pani consists of 250 g ghee from cow milk + 500 g honey + 200 litre water + 10 kg cow dung. Firstly, ghee is mixed with cow dung thoroughly followed by honey and then water is added to it. Farmers collect 25 kg soil from the base of banyan tree which is sufficient for sprinkling well-prepared Amrit pani on an acre uniformly. Normal earthworm count in an acre gets double (87120) due to enhanced energy and congenial soil environment. If the weight of one worm is 20 g which eats about the same quantity of soil, in 100 days, one worm can excrete 1kg excreta. Then 87 thousand worms will excrete 87 t of excreta rich in mineral nutrients, organic carbon, microbial population, organic acids, growth hormones and growth promoting substances.

G. Dead Animals

Dead animals (pet or domestic) were buried under the fruit trees such as mango tree. The dead animal contains large amount of biomass, mineral matter in the form of structure and bones specifically nitrogen in protein, phosphorus in bones etc.

H. Crop Rotation

Crop rotation helps in efficient use of nutrients. Farmers usually change crop rotation in every three or four years to have a better growth and performance of the cropping system. Stubble mulching is common in the high rainfall areas. Mulching raised the organic matter and nutritional status of soil.

2.36 WATER MANAGEMENT

Rain is essential for cultivation and the latter is essential for life, so one should first acquire carefully the knowledge about rainfall. Over a large part of the country rain has always been unequally and irregularly distributed and that is why Indian cultivators have sought to supplement the rainfall by digging wells and conserve it by tanks and storage reservoirs.

A. Ancient Irrigation

Archaeological investigations in Inamgaon in Maharashtra, India (1300 B.C.), revealed a large mud embankment on a stone foundation for diverting floodwater from the Ghod river through a channel. Rigveda mentions irrigation of crops by river water through channels as well as irrigation from wells. In the Rigveda, the word “well” frequently occurs (videante) and is described as “unfailing and full of water”. Water was raised from the well by means of a wheel, a strap and water pails, and also perhaps by buckets tied by rope to one end of a long wooden pole, working about a fulcrum near the other end that carried a heavy weight. The same old crude method is still prevalent in some parts of Northern India. Another method largely employed is to raise water by a small canoe tied by four strings-two at each side and worked between two men standing on a wooden platform projecting over a shallow reservoir. The canoe is swung to and fro, and at each end of the swing, water rises and pours out into the main channel. Macdonell and Keith find clear references to artificial water channels used for irrigation as practiced in the times of the Rigveda and Atharvaveda.

B. References in Epics, Arthasastra, Law-books and Jatakas

Narada enunciates, “No grain is ever produced without water, but too much water tends to spoil the grain”. An inundation is injurious to crops and drainage has to be provided. Definite sources from which water can be had on earth are the canals, wells, lakes, reservoirs, etc. During the season of clouds rainfall is certain either accidentally or through the will power of the sages. The rain water ‘poured

down by clouds in rainy season should be stored by the king in ponds, reservoirs, etc., for the benefit of the people, and preserved by him with special care; for agriculture solely depends on water. Therefore, all the water that can be gathered in the (rainy) season should be well preserved both by the kings as well as other prominent persons—this is the injunction of the great sage Kasyapa. Arthashastra of Kautilyas refers to sluice gates of tanks and mentions that ‘persons letting out the water of tanks at any other place other than their sluice gate shall pay a fine of six panas’ and persons who obstruct the flow of water from the sluice gate of tanks shall also pay the same fine. It is further stated that ‘the water of a lower tank, excavated later on, shall not irrigate the field already irrigated by a higher tank and the natural flow of water from a higher to a lower shall not be stopped, unless the lower tank has ceased to be useful for three consecutive years. Costs were levied on irrigated water regardless of the source. About the same time, 4th century B.C., the large Sudarshan lake was constructed in Gujarat and it was subsequently provided with conduits. In western India, the tradition of constructing tanks for irrigation continued throughout the ancient period. Buddhist literature (500–300 B.C.) provides evidence of building small tanks for irrigation (Randhawawa, 1980).

Extensive tank irrigation systems were developed in Sri Lanka and southern India during the first two centuries of the Christian era. Availability of irrigation made it possible to extend cultivation of rice to large areas, and thus improve food security. Sri Lanka knowledge of tank irrigation technology was most advanced. They could build large tanks and control release of water by 3rd century B.C. (Brohier, 1934). It is most likely that the contemporary and subsequent kingdoms in southern India got the benefit of Sri Lanka expertise in building tanks. The philosophy about the efficient 12th century Sri Lankan king. He stated, “In such a country, let not even a small quantity of water obtained by rain, go to the sea, without benefiting man”. As many as 14 large irrigation tanks existed in the northern half of Sri Lanka in the ancient times.

Topography of the Telangana region of Andhra Pradesh and Karnataka in India is ideally suited for the construction of tanks. A special feature of tanks in Telangana is their construction in series, by bunding the same valley at several points. Surplus water from one tank fed the tank at a lower elevation and so on. In Tamil Nadu, the Chola king Karikalan (c. 190 A.D.) and his successors constructed irrigation tanks off the river Cauvery through canals and several of these exist to this day. For the maintenance of tanks, a committee of villagers called eri-variyaam was appointed. The committee ensured repairs and desilting of tanks and distribution of water. During Pallava times (200–900 A.D.) arrangements were made for their repair and maintenance of building dams, embankments, tanks and aqueducts in southern India. Ancient dynasties from Mauryans to Mughals evolved various systems for soil water management such as anaicuts, earthen dams, field bunds, check dams, canals, tanks, ponds, wells and reservoirs. Babur observed two methods of irrigation from wells were with the aid of a wooden Persian Wheel and a leather bucket drawn over a pulley in northern India prior to Arab invasions.

C. Locating Water Table - Keys to the Finding of Water Source

Chakrapani in his ‘*Visva Vallava*’ has dealt in detail as how one can have an approximate idea regarding water below the surface of different kinds of lands, based on certain characteristics on the land. Generally water is found near or below a marshy place, at sea side, just by its shore, and in the desert, rocky and mountainous country far deep. From a mountain or from the root of a tree the underground artery (sometimes) goes below into a spring. At some places all the arteries are seen to terminate in caves. While digging if stone-like hard earth is reached and when struck it sounds like a thin slab of stone, then there is sure to be plenty of water beneath it. If in a place devoid of any water reservoir, there is found a rank growth of *Vetasa* (rattan), then there would be an artery of water two cubits below the surface

flowing towards the west. If rattan plant is seen growing in a place where there is no pool of water, then three cubits towards the west of that plant an artery of water would be found after digging seven cubits deep. If the tree *Ficus oppositifolia* is seen growing in a place devoid of a water reservoir of any sort, then three cubits towards its west there will be found an artery of water two and a half man-lengths below the surface of the earth. Where there stands an *Udumbarika* tree, there three cubits towards its west will be found a dark artery of water two and a half man lengths below the surface. If there is an ant-hill towards the north of an *Arjuna* tree, then three cubits towards the west of the tree, water is sure to be found at the depth of three and a half man-lengths. If a *Badari* (jujube) tree stands to the west of an ant-hill, then two cubits towards the west springs of water would certainly be found at the depth of three man-lengths. If there be the plant *Bhargi* (*Clerodendrum siphonantus*), *Danti* (*Croton polyandrum*) or *Malika* (double jasmine), then there is water towards its south at the depth of three man-lengths.

D. Locating Water in Arid Areas

Agriculture in India mainly depended on rainfall since ancient times. People knew that much of the rain water percolates through the soil and flows under ground through aquifers. Observations about ground water and its exploration have been made by Saraswata Muni who was well versed with botany and zoology and Manava Muni who was a geologist. According to their observations, the presence of an ant hill or that of a serpent den was regarded as an indication of the underground water. A number of trees like Banyan, Gular, *Palas* (*Butea monosperma*), Bilwa (*Semicarpus anacardium*) has water at a particular depth in a particular direction. Manava Muni surmises presence of water by colour of the soil or of rocks and stones. He has given a list of the plants or trees, which indicates presence of water. Varahamihira was the greatest astronomer of the 6th century A.D. who had made certain observations on water exploration. According to him water in the ground is available in an arid place near Vetasa plant (*Calamus rotalg*); gular tree (*Ficus glomerata*), where current of sweet water many be found; in place where bilwa and gular trees are found growing together; if there is an ant-hill to the north of arjuna (*Terminalia arjzma*) tree; if there is a coconut tree with ant hill; if nirgundi tree (*Vitex negzmdo*) is found with an ant hill; if ant hill is inhabited by a serpent and is near to the north side of Mahuwa tree (*Madhuka indica*); near the milky trees having long branches; at spots where trees, shrubs and creepers are fresh and fine and leaves are unborn and near grasses of specific types. Digging of wells was not very common and people depended more on the monsoons and river water. Shallow wells were dug through human labour and water was lifted through indigenous devices which operated on man and animal power. These wells were dug after careful selection of site and after ascertaining availability of ground water through water diviners.

Ancient teachers have enumerated many methods of divining water in arid regions. If there is seen hot vapour (rising from the earth) then there would be found a stream of water at the depth of two man-lengths and underground vegetation. The two-man-deep water would turn pale-white and disappear. There are signs approved by (the astrologer) Sanmuni by which now it is possible to divine whether there is adequate supply of water underground or whether the water is sweet. For the facility of people living in desert places there generally exists underground a rich stream of water as big as the trunk of an elephant. If to the north of a *Karira* shrub there is an ant-hill then there would be found sweet water towards the south at the depth of ten man-lengths, and at the depth of one man-length there would be yellow frogs. And if on the west of a *Rohita* tree then water would be found at a distance of three cubits and twelve man-lengths below the surface, and towards the west there would be a profuse stream of salt water. If there is an ant-hill of white colour then close to it towards the west there would be a water-vein at the depth of five man-lengths, and towards the west stones and yellow clay at the depth of one man-length. If there is an ant-hill to the east of which stands a *Pilu* tree, then at a distance of one man-length

to the south there would be water at the depth of seven man-lengths. At the depth of first man-length there would be found a snake with black and white spots and plenty of salt (water) at the depth of three man-lengths. If an ant-hill stands to the east of *Indradru* (*Terminalia arjuna*), then just at one cubit to the west there would be found water at the depth of twenty man-lengths and an iguana only at the depth of one man-length. If there be a group of five ant-hills at one place - the middle one being white in colour - then there would be water under a depth of fifty five man-lengths. If there be *Kusa* grass growing over an ant-hill or there be pale-white *adurva* then twenty one man-lengths below it would be found water.

E. Locating Water in Marshy Lands

In a marshy country there are green herbs and the land is wet and full of mosquitoes. There is *Andropogon muricatus*. There is plenty of sweet water underground at the depth of one man-length. Where there are succulent herbs such as *Ipomoea turpethum*; creepers (garuda), *Jyotismati* (*Cardiospermum helicacabum*), *Cyperus*, there water is found very near (the surface). Towards the south of a grove of thick trees and creepers there is plenty of water at the depth of four cubits. In a valley the land is low, covered with green turf, sandy, resonant and rich in water.

F. Locating Water in Mountainous Country

Sarasvata and Varaha described clear formulae with respect to the mountainous country. Where there is a cluster of the *Bodhi* tree, *Udumbarika*, *Palasa* and *Nyagrodha*, at one place, water would be found three man-lengths below them even in arid and marshy lands. The place where the trees have glossy and thick foliage and shrubs and creepers have milky juice has sweet water very near (the surface) and is inhabited by sweet-voiced birds. In a place where there grow *Kharjuri*, *Jambu*, *Sata-patra*, *Nipa*, *Sinduvara*, *Vata*, *Naktamala*, *Andumbari*, *Kakaranva* and *Vibhitaka*, there water would be found at a depth of three man-lengths.

Water is said to exist underground in a place where flowering trees and plants like *Jati*, *Kusthaka*, *Campaka*, etc., and fruit-bearing trees like the pomegranate, lime (*Citrus acida*) and citron are found to grow. Where on a hilly place the *Tala* tree, the coconut, tree, *Kancanara*, *Vetasa* or any other trees are found to grow, sweet water is found there in plenty. What has been previously described as a *Nirjahara* (water-fall or cascade) is found in a mountainous country issuing from the crevices between the rocks or from the roots of the trees. In a wet mountainous country a stream with a copious flow of water is generally found to flow from under the vegetation. Sometimes such a stream is also found to exist underground at holy places with shrines. Near the rocks that glisten like a copper vessel facing the east (*i.e.*, sun), or like glass and *Vaidurya* (eat's eye) or are bright like the pearls, or grey like the *Patasa*, or brown in colour, there is plenty of water. Where the dark blue soil or the black soil is found in conjunction with gravel, or where there is white coloured soil and sand or where there is yellowish soil, there exists sweet water. In brown soil the water is acrid in taste and in polish soil (of smooth surface) it is salt.

G. Construction of Reservoirs

After the location of underground water, **Chakrapani** describes in his book "*Visva Vallabha*" the construction of reservoirs in the following paragraphs: "When water has been located, reservoirs of various shapes and sizes should be constructed outside the villages, their sites and measurements being determined by the availability of space. An artificial reservoir may be of six shapes, *viz.*, circular, quadrangular (*i.e.*, square), triangular, polygonal, oblong and semi-circular (half-moon-shaped). Its

capacity may be ascertained after it is dug. The best reservoir should measure one thousand poles (or 4000 cubits) in length, medium-sized would be half of it and the smallest one quarter. The size of other reservoirs is determined by the availability of space. A big reservoir, in which there will always remain a large store of water, can be constructed at a lesser cost by constructing a dam between two hills, or in a mountain valley or on a spacious place at the top of a hill. If there be a wide and high table land on all sides with great influx of water and a narrow outlet for the exit of water, then a big reservoir can be made by constructing a dam there. A wise person should provide a descent of steps from the top of the dam to the bottom of the reservoir and for making the dam strong he should have it plastered with lime cement both on the inner as well as outer face.

A land low from all sides when full of water turns into a pond and becomes a natural reservoir. There can be no prescribed measurements for it. In the middle of the lakes and on their banks, there are pleasure houses of the kings. For the purpose of pleasure-trip or frolicking in water a boat should be kept there or an approach to the pleasure-house be made by means of a bridge (or causeway). A tank with three peaks (? angles) and one opening is called *Nanda*, that with *Bhadra*, the one with nine peaks and three openings is *Jaya* and that with twelve peaks and four openings is called *Vijaya*. If at the bottom of the well there is found to be sand, a foundation pedestal made of hard wood should be placed below in a manner that it does not block its springs of water.

A *Kunda* (pit) is of four kinds, viz., *Bhadra*, *Subhadra*, *Parigha* and *Nanda*. The first is four-sided, the second is *Bhadra*, the third *Subhadra* and in the middle the fourth connected with *Peatibhadra*. They (*i.e.*, the *Kundas*) should measure one hundred and eight cubits on each side with four openings, one in each direction, and a half in one corner provided with a quadrangular courtyard and ventilators inside. A very deep natural pool which has come into existence of itself may be of various shapes. Its embankments may be paved as they are with stone and lime mortar.

H. Changing Water Quality

Chakrapani in his book “*Visva Vallabha*” describes the methods to change water quality. If the powder of *Khadira* is poured into a well whose water is saline or acrid in taste, the water would be turned sweet. The turbid and pungent smelling water of pools etc. would turn sweet and pellucid if the powder as well as the juice of *Kakubha*, *Musta*, *Usira*, fruits of *Dhatiri* and *Kanaka* and of *Rodhra* (*Symplocos racemosa*) and *Rajasana* is poured into them. The juice of *Abhaya* (*Terminalia chebula*) and the powder of *Pathya* (*Terminalia citrina*), *Kustha*, Cardamom and *Kataka* fruit (*Strychnos potatorum*) along with the essence of *Khadira* and the fruit of wood-apple, if thrown in the turbid water or the salt water of well, they would at once turn the water (clear) and sweet.

I. Ancient Irrigation Systems

Devices for irrigation water lifting range from age-old indigenous water lifts to highly efficient pumps. Pumps operated by electric motors or engines have come into prominence in all large-scale lift irrigation schemes. There are several types of indigenous water lifts are in use in India. They may be manually operated or animal-operated. Based on the optimum range in the height of lift, they may be grouped under devices for low lift, medium lift and high lift.

Low Head Water Lifts: The swing basket, *don*, Archimedian screw, and water wheel are suitable when the depth to water surface does not exceed 1.2 m.

Medium Head Water Lifts: Medium head lifts are suitable when the height of lift is within the range of 1.2-10 m. The Persian wheel, chain pump, leather bucket lift with self emptying bucket, circular two-bucket lift and the counterpoise-bucket lift fall in this category.

High Head Water Lifts: *Rope-and-bucket lift*. The only indigenous water lift suitable for deep wells is the rope-and-bucket lift (*Charasa*) operated by bullocks.

J. Rain Water Harvesting Techniques

The most common practices followed by the farmers to conserve the soil moisture are summer tillage, field boundary bund with vegetative cover, use of farm yard manure and intercultural operation with hand/bullock drawn equipments. Farmers have followed the surface water harvesting rainwater harvesting techniques such as local percolation tank, farm pond, Tanka, Nada, Nadi, Talai, Talba, Khadin, Sar, Sagar and Samand. The water-harvesting methods differ from region depending upon rainfall, topography and soil type.

Tanka is constructed on farm in courtyard fort, etc. The shape of the Tanka is generally kept circular; however square Tankas are also constructed in buildings, forts and palatial buildings etc., for harvesting roof water, 2 m diameter and 3 m deep Tanka (capacity 10000 liter) is common. The Tanka is made on sloping land to arrest run off water in the farm however in house the construction is made on an elevated place to avoid entry of water into it.

Talai is about 2–3 m deep, the soil scooped out from the Talai is spread around to make catchments area keeping its slope in mind special attention is paid for selection of locations such that there is adequate flow of rainwater into the Talai. Care is also taken so that loose soil does not flow along with water stream into the Talai. In contrast to the Tanka, the Talai is kept open from the top. A pucca masonry ram entrance is also provided on one side of the Talai to facilitate distribution of water using camel, donkey, bullock cart, etc. The stored water is generally used for animals.

Nada is a common method of conserving rainwater in villages. Low-lying area in between hillocks the catchments area of the Nada is 5 to 10 ha. The Nada is constructed on rangeland, barren land, pasture land and agricultural field. It provides short-term storage of rainwater and mainly used for animals.

Nadi - Compared to Nada high embankment is provided around the Nadi. Depth of Nadi is kept up to 6–8 m. Catchments area of 10 to 150 ha is common for a Nadi. However area as high as 200 ha is found in certain specific cases. Nadi is generally constructed on slopy area so that excess runoff water flows out without causing any damage to the embankment. Adequate cleanliness is maintained in the watershed to maintain purity or stored water. Bath is prohibited inside the Nadi. In the Nadi, water is available for whole of the year as a result it is shelter home for many wild animals and birds.

Talab - Talab is relatively shallow and spread over to more area compared to Nadi Runoff from hillocks is channels to a low-lying area in the vicinity and adequately bunded to form a Talab. It is generally constructed on rangeland.

Khadin - Khadin is the ancient indigenous rainwater harvesting method mainly found in jaisalmer district. Accumulation of runoff water in between hillocks is known as khadin. Khadin means cultivation of crops in about 60–70 ha area. The khandi water is generally used for crop cultivation under preserved moisture conditions and animals consumption.

7. Sar, Sagar and Samand: In certain district of Thar Dessert sar, sagar and samand are used to harvest rainwater for irrigation purposes.

K. History of Salinization in India – A Lesson for the Future

Though the dug wells and constructed canals to supply water for crop production (2000-6000 B.C.), no record of the rise of salinity irrigated tracts is documented with the development of canal irrigation from the era of sultan Feroz Shah Tughlak (1351–88) to the fall of Mughal Empire (1857) the salty patches in the soil said to have developed due to canal irrigation. Disappeared when the canals went into disuse. Irrigation is a mixed blessing water-logging and salinity closely follow. In the past all such lands that used to be unfit for agriculture were called as ushra in Sanskrit meaning sterile or barren also called usar. Usar lands were adversely affected with arid climate or scarcity of water. Lands adversely affected with excess of salts, neutral (NaCl) or alkali (NaHCO_3 , Na_2CO_3) were also called as reh by geologists in mid-nineteenth century to characterize the appearance of salt efflorescence on the surface of lands. In the chalcolithic period (c. 1300 B.C.) irrigated farming which was developed in hilly uplands shifted to lower river valleys. Floodwaters were stored in reservoirs for irrigation in the valleys and canals were dug. Hence chalcolithic period is also called the era of irrigated farming. Archaeologists have found a canal constructed dating back to the pre-harappan period (3000 B.C.) at Kunal (Hisar, Haryana). Which was linked to the Saraswathi River about 5000 years ago. During the Vedic period (3700–2000 B.C.) the peasants dug wells and constructed canals to supply water to the crops. There is reference to irrigation by canals taken from the rivers there is also reference to soil erosion by rivers. The Aryans being in Northern India had experience on ushara land, 'Alkali soil'. The Chola King Karikalani (190 A.D.) and his successors constructed Vennara and Arasil canals, which take off from Cauveri river by means of channels drawn from dams, called anaicuts or dike.

L. Canal Irrigation in India

The development of canal irrigation began in the 14th century at the initiative of Sultan Feroz Shah Tughlak (1351–88), a pioneer in canal irrigation in the medieval times. During his period five canals were dug among these the most important was the Western Jamuna Canal. The salty patches in the soil, which developed under canal irrigation disappeared when the canal went into disuse after the fall of Mughal Empire in 1817. Blane was appointed by the Government of India to restore the WJC, which took 3 years due to paucity of funds. Alignment of the old Mughal canal consisting of natural channels and depressions was adhered, which resulted in the formation of large swamps and extensive water logging. The Eastern Jamuna Canal (EJC) was taking off from the river on its eastern bank near Naushera in Uttar Pradesh, which was designed by Ali Mardan Khan in the days of Shah Jahan. It was abandoned soon after construction due to the declining power of Mughals, but re-opened in January 1830. The Ganga canal belongs to the last years of the East India Company's rule. Cautley, in 1839, a military engineer, proposed to adopt a direct line from Hardwar to Roorkee. The canal was opened in April 1854 and irrigated large areas of Uttar Pradesh and the Pre-partition Punjab. Other canals constructed for protection against famine, viz., Sirhind Canal (Punjab) 1873–82, Lower Ganga Canal and the Betwa Canal (North-West Provinces), 1881-93. Mutha Canal and Khadakwasa Dam (Bombay Presidency), 1869–79 and the Nira River Canals (Bombay Presidency) 1877–94.

M. Advancement in Irrigation Potential during 20th Century

When the benefits of canal irrigation in British India became apparent, interest arose for such projects in some princely states. The pioneer was the Mysore state that planned a Kannabadi Dam, later named the Krishna Raja Sagar Dam (after the ruler of Mysore, Krishna Raja Wodeyar II), constructed under confluence of three rivers, viz., the Kaveri, Hemavathi, and the Kakshmanatirtha. Two canals, namely, the north bank high-level canal (Visvesvaraya Canal) and the north bank low-level canal, took off from the reservoir. The Nizamsagar Project was another irrigation project executed by Government of

Hyderabad (1924–1931). The project comprised of a dam across the river Manjira, a tributary of Godavari river. The Gang canal (1922–27), which takes off from the Sutlej River at the Ferozpur barrage on its left bank, was to irrigate land in the princely state of Bikaner. It was built with the initiative of Maharaja Ganga Singh (1880–1943) of Bikaner. The Sardar Canal Project in the United Provinces of Agra and Oudh was started in 1915 during the Viceroyalty of Lord Hardinge, and was completed in 1926. Government of India through Indian Council of Agriculture Research (ICAR) launched the All India Co-ordinated Scheme for studies on soil salinity and water management at different locations in 1968. It set up Central Soil Salinity Research Institute (CSSRI) at Karnal and Water Technology Centre at New Delhi in 1969. A part from these, another co-originated scheme on use of saline water in agriculture came in operation in 1972 at 5 centers in the state of Uttar Pradesh, Rajasthan, Karnataka, Andhra Pradesh and Maharashtra.

2.37 PLANT PROTECTION

Plant protection began when man attempted to understand ailments affecting crops. Crop plants are affected through ‘abiotic’ and ‘biotic’ disorders. Insects came on the agriculture scene more than 250 million years ago well before the human beings who appeared only about one million years ago. The association of man with insects was well known to Indians who knew production of silk and lac in the days before 3870 B.C. The documents available on man’s efforts to protect crops are found in the Rigveda (c. 3700 B.C.), Krishi-Parashara (c. 100 B.C.), Sangam literature of Tamil (200 BC–100 A.D.), Agni-Purana (c. 400 A.D.) Varaha Mihir’s Brhat-Samhita (c. 500 A.D.) Kashyapiyakrishisukti (c. 800–900 A.D.) Suprapala’s Vrikshayurveda (c. 1000 B.C.) Someshwara Deva’s Manasollasa (c. 1100 A.D.), Sarangadhara’s Upavanavinoda (c. 1300 A.D.), Tuzuk-e-Jahangiri (c.1600 A.D.) Dara, Shikoh’s Nuskha Dar Fanni–Falahat (c. 1650 A.D.) Jati Jaichand’s diary (1689–1714 A.D.) an anonymous Rajasthani manuscript (1877 A.D.) and Watt’s Dictionary of Economic Products of India (1889–1893 A.D.). Since the agriculture has a very long history of more than 10000 years its gradual development can be discussed briefly in the following periods for greater clarity: (i) The Ancient Period 10,000 B.C. to beginning of anno Domini (A.D.); (ii) The Medieval period beginning of A.D. to 18th Century A.D. and (iii) The Modern period –19th Century A.D. to date.

A. The Ancient Period

One of the major events in human history is the transition from hunting, gathering to agriculture. Susruta Samhita (400 B.C.) emphasized the importance of protecting seeds from white ants and Kautilya (321–296 B.C.) was the first to suggest use of seed dressers for producing healthy plant stands. There is reference to algae and mushrooms in Rigveda only as saprophytes. In the Buddhist document Kallavagga (C. 100 B.C.) “mildew of paddy” and blight of sugarcane” is mentioned. In Krishi-Parashara (Sadhale, 1999) we find that the plant protection in ancient days was not covered in depth, except for prayers to God Indra and other supernaturals. However there were several reference to the crop losses caused by insect pests. For example in the verse 126 it is stated “Commencing plowing on the 14th day of the month in any agriculture season was not shown as auspicious and met with several loss through insect pests”. Also emphasized were the auspicious “lagnas” for initiating agriculture in a particular season such as Turus (21st April) based on the movement of the sun’s entrance into the respective zodiac signs.

B. Use of Organic Materials

The oldest documents on the use of organic materials to control crop disorders is probably the Kautilya’s

Arthashastra (c. 300 B.C.) (Shamasastri, 1961), cut ends of sugarcane setts meant for planting were plastered with a mixture of honey ghee, the fat of hogs and cow dung. Varahamihira (Bhat, 1981) suggested use of milk ghee and cow dung for dressing seeds and smoking them by burning animals flesh or turmeric before sowing. He also suggested sprinkling seeds with a mixture of flowers of cereals legumes and sesame as well as stable minced meat. Literature in agriculture during with knowledge on seeds storage crop protection and use of botanical pesticides Neem leaves were commonly used to contain the storage insects and seed infection during storage. There is also a mention about the use of seed treatment with coal ash before storage to prevent insect damage during storage. Pigeonpea seeds were before storage (Sun drying of seeds to reduce moisture content) was a common practice during Ancient Period for the management of insect pests (Jeyarajan, 1999).

C. The Medieval Period

The earliest specific reference to insects pests is found in Krishi-Parashara. Rice pest, the gandhi bug (*Leptocorisa varicornis* F.) has been mentioned. Another word, pandarundi (White ear head) possibly implied rice stem borer (*Trporyza inctulas walker*) (Sadhale, 1999). Jahangir, the Mughal Emperor in India (1605–1627) in his memories described a disorder of marigold that could be ascribed today to species of *Alternaria botrytis*, or *Sclerotia*. The occurrence of melon fruit fly *Dacus* sp. during 1620 A.D. and the non-availability of control measures during that time were discussed (Nene, 1998). Jati Jaichand's diary (1658–1714) mentions possibly botrytis gray mould of chickpea and ear blight (*Curvularia penniseti*) of pearl millet (Javalia et al., 2001).

D. Practices Using Inorganic and Organic Materials

It was Someshwara Deva (c. 1126 A.D.), a Chaluyka king, who suggested treatment of seed with ash, besides other materials to ensure good germination (Shamasastri, 1926): Use of ash however was suggested as far back as 120 B.C. by Varro a Roman encylopedist (Orlob, 1973), and was known to Tamils (Jeyarajan 1999). Dara Shikoh (Razia Akbar, 2000) mentioned the use of common salt solution for soaking fig cuttings prior to planting. Apparently salt was used to disinfect cuttings. Unfortunately concentration of salt solution was not mentioned.

Nuskha Dar Fanni-Falahat (Razia Akbar, 2000) has many recommendations to project plant species from insects, fruit-drop, fruit cracking heat, and cold. These are:

- Use of dung garlic, and pine oil should protect the cuttings from damage by some insects and pathogens. Burning of garlic was recommended for “expelling caterpillars” by the Roman author Palladius (Orlob, 1973).
- Resin application to roots has been recommended for preventing cracking of pomegranate is found in ancient literature.
- Application of excreta of sheep, pig and donkey and human urine can at best keep the apple tree well nourished which in turn perhaps keeps insect and diseases damage animals.
- A practice that is still followed to protect melons from excessive heat or cold has been mentioned. Covering melon fruits earthen pots is a practice that small farmers can follow today.

E. Fumigation

Diseases of cucurbits were controlled through smoking by burning the bones of cow and dog mixed the excreta of cat (Sadhale, 1996). For the control of insect pests several ancient recommendations available are given in Table 15 (Saxena and Choudhary 1996).

Table 2.9. Some Important Products used in Pest Management during Ancient and Medieval Periods in India

Root of vasika (<i>Justicia adhaatoda</i>)	Varahamihira (505–587 A.D.)	Soothing effect, insecticidal, antifungal antibacterial anthelmintic
Branches and leaves of atimuktaka (<i>Hiptage banghalensis</i>)	Varahamihira (505–587 A.D.)	Leaf juice insecticidal: bark contains glucoside (hiptagin and tannis)
Mustard (<i>Sinabis alba=Brassica alba</i>)	Surpala (1000 A.D.)	Insect antixenosis and antibiosis
Bidanga (<i>Vidanga Embelia ribes</i>)	Surpala (1000 A.D.)	acaricidal: nematocidal and antifungal
Ash	Someshwara Deva (1126 A.D.) Someshwara Deva (1126 A.D.)	Anthelmintic: antibacterial: Desiccated insects eggs on seed: speeds up germination by softening seed coat through mild alkalinity; provides micronutrients
Sesame (<i>Sesamum indicum</i>)	Surapala (1000 A.D.)	Allelopathic to rice insect repellent insecticidal
Mahua (<i>Madhuca spp.</i>)	Surapala (1000 AD)	Insecticidal oil; piscicidal antibacterial
Kusta (costus) (<i>Saussurea lappa</i>)	Surapala (1000 A.D.)	Insecticidal (repellents anti-feedant); antiseptic
Bhillata (Bhallataka) (<i>Semecarpus anarcardium</i>)	Surapala (1000 A.D.)	Insecticidal; antiseptic termite-repellent mildew and moth-proofing of cloth anthelmintic; antibacterial

- Insects infesting trees could be removed by smoking a mixture of white mustard, black pepper, asafoetida, *vidanga (Embelia ribes)*, *vaca (Zingiber zerumber)*, and water mixed with beef horn of buffalo flesh or pigeonpea and the powder of bhillata (*Semecarpus anacardium*)
- Sprinkling water mixed oil cake could control insects infesting creepers.
- Dusting cow dung ash and brick-dust could destroy leaf-eating insects.

Table 2.10. Information contained in Surapala's Vrikshayurveda, related to Kinds of Internal Disorders observed in Trees and Symptoms Attributes and Remedies Suggested

Symptoms	Caused elaborated	Possible causes
Vata Trunk slender and crooked, knots on trunk or leaves; hard fruits (less juice and sweet) gradual defoliation flower and fruits	Arid land on account of excessive supply of dry and pungent substances	Underground mechanical barrier: leaf insects, root infecting fungi or nematodes viruses saline/alkaline soils
Pita Leaf yellowing, premature drop/strong decay of flowers and fruits	Occurrence at the end of summer if trees are excessively watered with bitter, sour salty and sore substances	Viral disease salinity in irrigation water. Predisposal to blossom blight and fruit decays due to fungal/bacterial infections
Kafa Fruit bearing delayed and fruits are tasteless and ripen prematurely oozing without wounds	Appears in water and spring if trees are excessively watered and spring if trees are excessively watered with sweet, oily sour or cold substances	Fungal gummosis/rot: nutrient deficiencies or toxicities: excessive watering

Reproduced from Sadhale (1996) and interpretation of causes in the context of present-day knowledge

- Trees were watered with cold water for days to remove insects from the roots and branches.
- A wound caused by insects was healed if sprinkled with milk after being anointed with mixture of vidanga, sesame, cow's urine, ghee (clarified butter), and mustard.

Honey, mustard and licorice too possess antimicrobial properties cow dung which is unusually mixed with urine has antiseptic properties. In addition cow dung can promote biological control. Milk could act as good sticker and may also promote biological control of pathogens. In the 17th century, document of Dara Shikoh (Raizia Akbar, 2000) use of cow dung for smearing the cuttings of fig before planting is mentioned. Garlic finds a mention especially for insects control (Raizia Akbar, 2000). In a 19th century document from Rajasthan (Javlia 1999), some interesting practices mentioned are: (1) use of foliar and soil applications of oil (sesame) to trees from frost and termites; (2) Sprinkling of curd (91) mixed with asadoetida (112 g) on trees to prevent powdery mildew; and (3) use of *Asafoetida exbelia* ribes mixed with curd every 10 days to protect canker (or anthracnose of orange).

Use of cow dung for dressing seeds, pasting cut ends of vegetative propagating units such as sugarcane setts, dressing wounds sprinkling diluted suspension on plants and applying to soil has been indicated since the time of Kautilya (c. 300 B.C.). Indian farmers continue to use cow dung in various ways but the agriculture scientists have ignored use for purpose other than use as manure.

F. The Modern Period

G. Watt whose six volumes of "A dictionary of economic products of India" (published from 1889–1893), which include description of disorders of crops covering a period since 1820. Watt (1889–1893) mentions several fungal disease such as (i) ergots of barley oats, pearl millet and horse gram (?), (ii) smut and rust (*Puccinia sp*) of wheat (iii) leaf rot of coconut (*Pellicularia koleroga*), (iv) rust of barberry (v) rust (vi) rust (white rust) of mustard (vii) late blight of potato (viii) powdery and downy mildews of grape vine (ix) root blight of tea (x) bunt of wheat, (xi) smut and rusts of barely and maize, (xii) false smut of paddy, (xiii) blight of cotton (xiv) *Cercospora* leafspot of cotton in Madras (Chennai) (xv) powdery mildew of indigo (xvi) rust and smut of pearl millet in western united provinces (Uttar Pradesh) (xvii) mildew (*Cercospora sp*) of black gram (xviii) ring disease of betel vine in Bengal (xix) whip smut of sugarcane and (xx) rust and smut of sorghum. Dipping seed in salt solution was a practice in 19th century (Gupta and Raje, 1896). Ozanne was the first to use copper sulfate to control sorghum smut by dipping in solution (85 g copper sulfate in 1150 ml water) the use of Bordeaux mixture (copper sulphate and lime) developed in France in 1882 was first documented in India by Butler in 1906. Sulfur was also used in 1906–1907 in India (Bhagwagar and Patel, 1999).

G. Pesticides

Mustard paste or suspension is known to possess antifungal, acaricidal, nematicidal, and insecticidal properties. The sprouting mustard seeds around the packed betel leaves would release a volatile anti-fungal gas.

H. Increased use of Animal Wastes for Manure

Kunapa, the liquid manure, is better for plants than the composts from plant residues. There is always a danger of passing on dormant pathogens to fields with plant-based composts. There should be no such danger with application of kunapa water. Also the animal wastes are likely to provide micro flora that might give better biocontrol of plant pests and disease than plant-based composts, and also attract predators of plant pests. From the volumes of the dictionary of the economic products of India by Watt (1889–1893), the available information on the practices followed in the 19th century India are:

(i) application of cattle manure to pigeon pea to reduce frost damage; (ii) application of *Calotropis gigantea* for two years (seasons) to reclaim soils with salts efflorescing; (iii) sanitation, i.e., removal of all dead organic matter from the betel leaf sheds to prevent spread of diseases; and (iv) reduction in betel vine disease (gandi = collar rot) by soil application of onion juice mixed with cow dung.

I. Relevance to Present Day Sustainable Agriculture

The present day concept of integrated pest management (IPM) is mainly oriented towards the eco-friendly approaches considering the human and animals health and other profits. The use of botanicals and other safer chemicals. In fact this is not new and there was ample evidence that our ancestors had knowledge and experience and lived under healthier environments than the present situation. Though Indian agriculture in the modern age is making large strides of progress it is necessary to consider the treasure of ancient knowledge particularly the development and use of safer pesticides for the development of mankind.

J. Harvesting, Threshing and Storage

In Riveda, harvesting of barely with sickles was mentioned. Harvesting was done both by cutting down the crop at ground level and by cutting off the earheads. Threshing was done on the threshing floor and winnowing with a supa. Cleaned grain was stored in storage bins and a trash burned. In Krishi-Parashara, making of a levelled threshing pit and installation of a threshing pillar called medhi were mentioned. The wood for the pillar was obtained from a tree that produces milky sap, obviously to get wood that is not too hard lest the grain is broken. The pillar was treated with neem (*Azadirachta indica* A. Juss) leaves and mustard.

Parashara mentions adhaka, a wooden vessel with a capacity of about 3.5 kg (paddy rice). The grain was stored at a place safe from termites, rats, and other pests. Kautilya's Arthashastra states, "Grain and other crops shall be collected as often as they are harvested crops. When reaped, shall be heaped in high piles or in the form of turrets. The crops piles shall not be kept close. The threshing floors of different fields shall be in close proximity. Workmen in the fields shall always have water the stalks by beating them on the ground or by making the bullocks tread on them. Cleared paddy was collected, measured and stored in proper places. Sickles and swords were used for harvesting millet heads. For threshing, buffaloes were made to tread or men used to thresh the ears with their feet. Black gram was threshed with sickles. Women considerably contributed to threshing and cleaning. A common vessel for measuring grain was referred to as ambanam.

K. Post Harvest Storage Pest Management

A majority of farmers were found to do threshing of maize and paddy manually. To prevent food grains from insect infestation, use of neem leaves, ash, salt, camphor, etc., either singly or in combination was common. For storage of seed, use of kerosene + ash, and onion was popular. Some of the respondents were mixing neem paste, kerosene, or sheep or goat faces with mud for use as plaster of the storage structure. Use of indigenous practices for controlling the rats like live-traps keeping dogs and cats, filling the burrows with ash, pieces of glass, bunch of hair and then plastering them was common in the tribal as well as non-tribal areas. Indigenous practices used by the respondent in storage of produce are: (i) Cow dung cake + neem leaves, (ii) Neem + mud (for plastering), (iii) Mud + kerosene (for plastering), (iv) Mud + faces of goat/sheep (for plastering), (v) Neem + ash, (vi) Ash + mercury + Ash, (vii) Husk, (viii) Ash + salt (rice), (ix) Neem + ash + campher, (x) Neem + husk, (xi) onion for seed, etc.

2.38 GARDENING IN ANCIENT AND MEDIEVAL PERIOD

Gardens were an indispensable feature in house and town planning in ancient times. Excavations at Harappa have indicated that people were familiar with date palm, pomegranate, lemon, melon, and possibly coconut. Rigveda mentions several trees such as papal (*Ficus religiosa* L.), Khadir (*Acacia catechu* wild), Shisham (*Dalbergia sisoo* Roxb.), Shimbalam (*Bombax malabaricum* DC) and palasa (*Butea frondosa* Roxb.). The Aryans of Vedic times were quite understandably lovers of nature. The name they gave to flowers, sumansa, “that which pleases the mind”, reveals their aesthetic sensibilities. It is these sensibilities which were reflected in their gardens and a very refined art of gardening. In Artha Sastra, more than 30 tree species are mentioned as those found in forests and edible fruit trees are mentioned without qualification. Emperor Ashoka (274–237 B.C.) encouraged arbori-horticulture. Commonly grown fruit trees were plantain, mango, jackfruit and grapes. The Sangam literature refers to jackfruit, coconut, date palm, arecanut, plantain, and tamarind. Agnipurna mentions many trees; it has a separate PART on horticulture which formed the base of treatises that followed. Varahimihira wrote a PART on “treatment of trees” in his Brhat-Samhita. One of the highlights of Varahimihira writing is specific reference on grafting to be done on trees such as jack fruit, plantain, jambu (Black plum) Kapittaha (*Limnoia acidissima* L.) lemon and pomegranate. A method of grafting described was what is known today as the ‘wedge grafting’.

Gardens continued to be an equally important part of the urban landscape in subsequent periods. In Vatsayana’s *Kamasutra* (300–400 A.D.), “*Vrakshayur veda*” is mentioned as one of 64 kalas or arts recognized in ancient India. It included the construction and maintenance of gardens and parks for health, recreation and enjoyment. In Jain canonical texts too, among the important parts of a city mentioned are pleasure gardens (*arama*), gardens (*ujjana*) and tanks (*vapi*). Gardens continued to be viewed as a source of joy and happiness throughout the ancient period. As the very first verse of the ancient text *Vrkshayurveda* puts it: “He is indeed a monarch if his house has extensive gardens, spacious gardens containing large pools of water with lovely lotus blossoms over which humming bees fly . . . That may be regarded as the consummation of all happiness . . . (giving) intense pleasure to the mind.” The ancient texts have their share of information on the subject. The pleasure grounds surrounding Indraprastha are described in the *Mahabharata*. The Buddhist text Lalitavistara mentions 500 gardens around Kapilavastu, which were laid out for Prince Siddhartha. The divine Nandanakanan is the god of gardening in Indra’s paradise. The ancient Indian kings built pleasure gardens of immense beauty for themselves. Megasthenes admiring the palace of Chandragupta wrote, “In the Indian royal palace . . . in the parks tame peacocks are kept and pheasants which are domesticated, there are shady groves and pasture grounds planted with trees, . . . while some trees are native to the soil, others are brought from other parts and with their beauty enhance the charm of the landscape.” The early Buddhist period saw the transition from royal to public gardens at many places. The *Venuvana* and *Ambavana* in the vicinity of Rajagaha, the *Mahavana* near Vaishali, the *Nigrodharama* near Kapilavastu and the *Jetavana* in the outskirts of Sravasti were all royal gardens of early Buddhist times which later were opened to public and converted into permanent retreats for the monks of different orders. Subsequently many monasteries had their own gardens attached to monastic complexes.

Horticulture was well developed in the ancient times referred to in the Jaina canonical literature. Various types of gardens are mentioned in the canons. Examples are Ujjana (garden), Nijjana (the king’s private garden), Arama (garden with canopies as resting places), Sahasramravana (mango grove with a thousand mango trees), Agrodyana (home garden in front of the buildings), Ashokavana (garden with ashoka trees), Gunashila Udyana (ornamental garden) and Jeernodyana. These gardens had trees, bushes,

shrubs and creepers of various kinds some flowering and others fruit types. Aramas canopies covered with dense creepers that protected the gardens from sun rays and provided cool comfort to the dwellers therein.

This is how the Chinese pilgrim Hsieux Tsang who arrived at the monastic University of Nalanda in 630 A.D. saw it: “The temple arose into the mists and the shrine halls stood high above the clouds . . . streams of blue water wound through the parks; green lotus flowers sparkled among the blossoms of sandal trees and a mango grove spread outside the enclosure.”

As regards gardens attached to a private dwelling, obviously of the rich and opulent, we have a description in Vatasayan’s *Kamasutra*. It states: “attached to every house there should be a *vrksavatika* or *puspavatika*, a garden where flowering plants and fruit trees can grow, as well as vegetables. A well or tank, large or small, should be excavated in the middle.” The garden was to be in charge of the mistress of the house and she was to procure seeds of common kitchen vegetables and medicinal herbs every day. The garden was also to be designed with bowers and vine groves with raised platforms for rest and recreation. A swing was to be fitted on a spot well guarded from the sun by a canopy of foliage. She was to ensure that it was laid out with beds of plants that yield an abundance of flowers, with an emphasis on those with sweet perfume, like the *mallika* and the *navamalika*, as well as those “that delight the eye like the japa with its crimson glory or the *kurantaka* with its unfading yellow splendour. There should also be rows of shrubs yielding fragrant leaves or roots, like *balaka* and *usirs*”. As in all hot climates an expanse of water was an almost essential feature of the ancient garden. Gardens consist of the artificial lakes and pools as well as the steps leading down to them for bathing. Kalidas mentions a palace garden called *samudragrha*, which was a summer house, built in a cool place surrounded on all four sides by fountains. A further refinement, for cooling the air in the hot season, was the water machine, *variyantra* which, from Kalidasa’s description seems to have been a sort of revolving spray, rather like the one used to water lawns. The garden’s irrigation was taken care of by means of narrow drains (*kulya*) full of running water with water fountains as their source. Water wheels incessantly threw jets of water to flood the flower beds and the circular ditch (*alavala*) at the base of the trees. As noted earlier, along with the private gardens of the rich there were in due course public gardens (*nagarupvana*) as well. When situated outside the town they were termed *bahirupvana*. These were the favourite resorts of the townspeople for *udyanyatras* or picnics. The *Kamasutra* mentions how a party of well dressed *nagarakas* would go out of the town to these gardens early in the morning mounted on horses accompanied by *ganikas* and followed by servants to spend the day.

With gardens and parks emerging as an important backdrop to the social life in ancient India, horticulture (*udyanavyapara*) developed as a discipline and scientific knowledge was applied to the art of arbori-horticulture. In the post Vedic literature there is evidence to show that botany developed as an independent science known as *Vrkshayurveda* on which were based the science of medicine (as embodied in the *Caraka* and *Susruta samhitas*), the science of agriculture (as embodied in the *Krsi Prasara*) and the science of horticulture (as illustrated in the *Upavanavinoda*). While there are no treatises so far discovered on the subject of ancient horticulture as such, there is a small part, the *Upavanavinoda* as a branch of *Vrksayurveda*, in *Sarngadhara*’s encyclopedic work, the *Sarangadhara Paddhati* of the 13th Century, which is a compilation of relevant material from earlier classical sources.

A. Management in Gardens

Management and maintenance practices for parks and gardens too came to be formulated. In Kautilya’s time there was a separate department entrusted with the care of gardens and forests. The cultivation of

parks for public health and recreation was one of the duties of the forest officers. The *aramas* or gardens were kept in order by a number of junior officers known as *aramikas*. They were under a superintendent *aramaprekshaka* who supervised their work. There were settlements of park keepers known as *aramika gama*. Special classes of skilled artisans were patronized by the State. Vatsayana's *Kamasutra* mentions well trained experts, the *aramadhipatis* and a special class of skilled artists, gardeners and weavers, *malakars* and *malinis*. Gardens at times contained not only flowering plants but also fruit trees which used to bring considerable income to the exchequer. Gardening in ancient India through design forms and mechanisms and by combining scientific and artistic principles thus ensured an integration of nature with everyday life in urban areas.

2.38.1 Arborescence, Orchards, History and Diversity of Fruit Crops in India

A. Tree culture (*Vrksayurveda*)

The water reservoirs which have no shade on their banks are not pleasing. Hence gardens should be laid in the precincts of reservoirs of water. Soft soil is good for all kinds of trees. First, one should sow sesamum in that soil and when they grow and put forth flowers, they should be uprooted. This is the first process in preparing the land. The astrologers have declared the constellations such as Dhruva, Mrdu, Mula, Visakha, Brhaspati, Sravana, Aswini and Hasta to be auspicious for the planting of trees. The soap-nut tree, Asoka, Pumnaga, Sirisa, Pdyangu, are the auspicious trees and should be planted first in the gardens or the houses. The bread-fruit tree, Asoka, the plantain, the rose-apple, Lakuca, the pomegranate, the vine, Pativata, the citron and Atimuktaka-these are the trees that grow from scion plastered with mud. They should be carefully planted by taking their stem or by digging them up from the roots. Plants that have not put forth branches should be transplanted in the winter; those that have put forth branches, in the beginning of winter (*i.e.*, the dewy season); and those that have developed trunks, at the advent of the rainy season according to their respective quarters. Transplanting of the trees is done after plastering the root and branch with ghee, usira, sesamum, honey, vidanga, milk and cow dung. The rose apple, Vetasa, Vanira, Kadamba, Udumbara) Atjuna, the citron, the vine, Lakuca, the pomegranate, Vanjula, Natka-rnala, Tilakll, Panasa, Timira and Amrataka are the sixteen trees that grow in the wet or marshy soil. A pit one cubit wide and twice as much deep should be dug and filled with water. When it becomes dry it should be heated with fire and then plastered with honey and ghee mixed with ashes. It should then be filled with ground Masas, sesamum and barley mixed with soil. Then pouring the broth of the flesh of fish over the filling, it should be beaten down till it becomes hard and compact. If the seed is sown into it four fingers deep and is nurtured with fish-broth and gravy, it grows into a surprising creeper with glistening leaves and soon spreads over the entire bower. Seeds that are soaked in milk for ten days, kept in two hast as of ghee, fumigated with the fumes of the flesh of a hog and deer, and mixed with the fats of fish and hog, grow bearing flowers simultaneously, when sown in a prepared and cleaned soil and nourished with water mixed with milk. Cessation of bearing fruit (*i.e.*, sterility) is cured by Kulattha, Masa, Mudga, sesamum and barley. Along with this, nurturing with boiled and cooled down milk is conducive to the increase of fruit and flower. Two adhakas of the dung of sheep and goats, one adhaka of sesamum, one prastha of meal, a *drona* of water and beef equal in weight-all these (mixed together and) kept for a week (lit. 7 nights) should be administered as nurture to trees, creepers, thickets and plants for making them bear flower and fruit for all times. Diseases like the searing of leaves, all rest of the growth of leaves, drying up of the branches and excessive exudation of the sap afflict the trees owing to exposure to cold wind and the sun. Their remedy, according to scientific works, lies first in clearing them (of the diseased part) and then plastering them with the paste

of Vidanga and ghee and nurturing them with water mixed with milk.

Buddhism adopted the cult of tree worship from the older religions, which prevailed in the country (Sixth century B.C.). Gautam Buddha was born under 'ASHOKA' (*Saraca indica*), attained enlightenment under 'PIPAL' (*Ficus religiosa*), preached his new gospel in mango (*Mangifera indica*) groves and under the shady 'Banyan' (*Ficus benghalensis*) and died in the 'SAL' (*Shorea robusta*) grove. Most important trees of ecological value were identified with the name of saints who were revered and worshipped in the society during that period.

Name	Botanical name	Name of saint
Pipal	<i>Ficus religiosa</i>	Sakya muni
Banyan	<i>Ficus benghalensis</i>	Kashyapa
Gular	<i>Ficus glomerata</i>	Kanaka muni
Siris	<i>Albizia lebbek</i>	Krakuchhanda
Sal	<i>Shorea robusta</i>	Vishwa bahu
Ashoka	<i>Saraca indica</i>	Vipaswi

Buddha attained perfect wisdom under the PIPAL tree; hence it is called the "tree of knowledge". People during the period of Buddha were involved in tree planting and in every village 'Banyan' and 'Pipal' trees were planted. Never before or after has religion been so much associated with the tree culture and tree planting. During 237 B.C., emperor Ashoka actively promoted tree planting on large scale. For the first time in the Indian history, a monarch has encouraged tree culture and adopted it as a state policy. He encouraged planting of trees in the gardens, along road and in the form of avenues. Mughal emperor Jahangir (1616–1674) was the greatest builder of gardens in India. The famous gardens of Kashmir, Shalimar, Anantnag and Verinage owe their existence to him. In ancient India messages were given through religion to establish sound traditions based on the realization that partnership between the women and nature ensured sustenance. Women were therefore actively associated with tree culture and in many places trees like Pipal, Banyan, Gular, Siris, Sal, Ashoka, Aonla, Neem and Shami (*Prosopis cineraria*) were worshipped. The leaves of Mango and Neem were considered auspicious and leaves and flowers of Tulsi (*Ocimum sanctum*) and Marigold were used for worship. Tulsi' was the symbol of cosmos. All these traditions are practiced in India even today. The ancient Indian civilization was primarily dependent upon and intimately related with forests and flora in Sanskrit scriptures (like Vrikshayurveda, Upavana vinoda, Brhat Samhita, etc.) the science of plant life has been described and three indigenous fruits viz., mango banana and jackfruit are extensively mentioned.

Archaeobotanical indigence record wild date, jumbos, banana, jujube, apricot, breadfruit, etc. There is a rich heritage of mango varieties in India. Mango fruit had attracted the fancy of Moghul rulers especially there are choice varieties like Alphonso, Dashehari, Mulgoa, etc. In citrus natural interspecific and intervarietal hybrids occur extensively in rootstock material which have been found to carry tolerance to viruses and root diseases. Indigenous citrus germ plasm provides a good source of parents for rootstock breeding programs. In temperate fruit wild species of Prunus, Pyrus and Malus have been recorded in Himalayas and these carry resistance to root rot and collar and cold hardiness.

A Sanskrit treatise "Sarangathara Padhati" an anthology compiled by Sarangadhara—a courtier of king Hammira, contains Padhati" an anthology compiled treating arbori-horticulture (translated by

Majumder 1935). In *Brhat Samhita* (ca 500 A.D.) there are reference on the methods of propagation like cuttings, grafting and about plants suitable for different methods of propagating propagation of jackfruit, jamun and fact Sadhale (1996) draws a close parallel and resemblance among “*Vrikshayurveda*” of Surapala (ca 1000 A.D.) “*Upavana Vinoda*” of Sarangadhara and Varaha Mihira’s “*Brhatsamhita*” in respect of science of plant life. The *Brahma Vaivata Purana* (around 800 A.D.) lists some good fruits which include indigenous ones like mango (amra), banana (kadali) jackfruit (panasa), bael (sriphala) and introduced but ancient ones like pomegranate (dadima) date (khajura) and grape (draksa) (Sensarma, 1989) (Table 17). Four fruits, *viz.*, mango, banana, bael and jackfruit are considered as ancient and sacred fruits extensively used in pujas, religious festivals and ceremonial occasions.

Table 2.11. Fruits mentioned in the Puranas

Dadima (Pomegranate)	(E)	Vayu, Mastsya, Brahmavaivarta Brahma, Kurma
Khajura (Wild Date)	(E)	Vayu, Mastsya, Brahmavaivarta Brahma, Kurma
Jambu (Jamun)	(I)	Vayu, Kurma
Amra (Mango)	(I)	Vayu, Brahmavaivarta, Brahma, Agni, Mastsya, Kurma
Panasa (Jack fruit)	(I)	Brahmavaivarta, Vayu, Brahma, Mastsya, Kurma
Kadali (Banana)	(I)	Vayu, Mastsya, Brahmaviarta, Brahma, Agni
Narikela (Coconut)	(I)	Brahmavaivarta, Agni, Brahma
Sriphala (Vilva/Bael)	(I)	Brahmavaivarta, Vamana, Kurma

I = indigenous ; E = exotic

Source: Sensarma, 1989.

The Indian sub-continent is a center of domestication and diversity of wide array of plant materials and Vavilov (1949) designated this center as Tropical South Asian Center. Zevan and De wet (1982) assigned this as “Hindustani Center” as an important region of diversity of crop plants. The Moghuls Spaniards, Portuguese and the British introduced new fruit crops such as apple, pear, peach, apricot, grape, almond, date palm, cashew nut, litchiu, strawberry, blue berry and pine apple. Fruits plants introductions into India occurred during the ancient times through traders, invaders, travellers etc. Thus grape is reported to have been introduced in tropical India during 620 B.C. (Olma, 1976) and subsequently by invaders from Afghanistan and Persia in 1300 A.D. Pomegranate, sapota and loquat reached India so early that their exact period of introduction is difficult to trace. Hiuen Tsiang, the Chinese pilgrim, mentioned the presence of pomegranate in 629 A.D. stated that loquat was not present. He also saw grapes, pear, peach, plum, apricot and *Diospyros sp.* Custard apple was perhaps introduced into India even before Portuguese brought the other species of *Annona*. Pineapple reached India as early as 1548. Both pineapple and custard apple are recorded in *Ain-i-Akbari*. Fruits like guava and papaya introduced in the sixteenth century and litchi in seventeenth century naturalized so much that these appear to be native in India. Most of the present day commercial cultivars of these fruits are selections from the variability generated by the introduced types.

After 1870, European and American settlers and Missionaries carried out introductions of pome, stone and nut fruits. During this period, Captain Lee in Kullu valley, Coutts in Shimla and Stokes in Kotgarh made valuable introductions in Himachal Pradesh (Singh 1669). A Frenchman, Pychard introduced many varieties in Kashmir between 1910 and 1920. Consequently, several varieties of different temperate fruits namely apple, pear, peach, plum, apricot, walnut and almond fully adapted

and established in India temperate regions. The prominent cultivars among these were red Delicious, Golden Delicious, Cox's Orange Pippin, Red Gold, Richared, Starkings Delicious, Granny Smith and Yellow Newton of apple besides Ambri introduced from Central Asia. William's Bartlett, Conference, Winter Nelis, Keiffer, Fertility and Beurre Hardy of pear; Stark Lambert, Biggarreau Noir Gross, Redford Prolific and Early rivers. Crawford's Early and C.O Smith of Peach, Santa Rosa, Beauty, Green Gage, Mariposa, Maynard and Grand Duke of Plum; New Castle, Royal Moorpark, St. Ambrose and Turkey of Apricot and Thin Shelled. Not Pareil and California Paper Shelled of almond.

2.38.2 Important Finds of Fruits from Archaeological Sites

Fruits - Wild date, tamarind, Indian jujube, Indian jambos, vine, apricot, Indian cherry, emblica myrobalan, wild banana, wild canarium, wild breadful Indian almond (Kajale, 1991, 1996).

A. Mango

A pre-eminent tropical fruit—has been described as the “choicest fruit of hindustan” by Moghuls History records the fact that mangoes have been cultivated in India nearly 4 to 5 thousand years ago. It has been closely associated with Indian way of life since time immemorial and has a universal appeal to all sections of the society. Hindus considered mango tree as the symbol of “Prajapati Lord of Creation. Mango tree is believed to be useful in scaring away evil spirits (Malla, 2000). The nutritive value of mango has been mentioned in Kurma Purana.

Brahadaranyaka Upanishad (1000 B.C.) and a little later Shatapatha Brahmana mention the mango tree. Lord Buddha (563–483 B.C.) was accustomed to resting under the shade of mango tree. In Jataka literature of Buddhists reference to mango has been noted. Similarly in Jain literature written after Lord Mahaveera (540–468 B.C.) mango trees are called Sahasramravana”. Mango fruit has attracted Babar the founder of Moghul Empire in Indian. He dot established “Lakh Bagh” near Darbhanga in Bihar and description of mango in “Ain-i-Akbari” is very detailed His son Jahangir, a Naturalist was an admirer of mango fruits. Mango orchard became a prerogative of Nawabs during Moghul period especially in Uttar Pradesh and Bengal and grafting was permitted only in royal gardens. Europeans especially Portuguese French and British traders and travelers took a fancy for mango fruits. Early foreign travelers Hieuntsang (632–645 A.D.) Ibn Hankul (902–968 A.D.) Ibn Batuta (1325–1349 A.D.) and Ludo bici Verthena (1503–1508 A.D.) all praised the mango fruits as they made mention of it their travelogues. Grafting method of vegetative propagation become a common practice by then, mango varieties Alfonso, Pairi safeda, Fuzlee, Langra, Mulgoa, Banganpalli etc., have become popular. Mango originated in northeastern India along with the adjoining region of Myanmar.

B. Date (*Phoenix sp.*)

A mention has been made of wild date in Ramayana as growing in panchaavati and it is also seen in the potters of Mohen-jo-daro.

C. Fig (*Ficus sp.*)

Bruhadaranyaka Upanishad has recorded this tree, indicating its antiquity. Besides it has been recorded in Ramayana and Mahabharata.

2.38.3 The History of Gardening: A Timeline from Ancient times to 1600

35,000 BCE (BCE = Before the Common Era or Christian-Roman Era) - Homo sapiens at the end of the period had knowledge of many plants derived from food gathering techniques. Different kinds of fruits, nuts, and roots were only gathered, not cultivated.

4000 BCE - Indus Valley agriculture is very extensive: wheat, peas, sesame seed, barley, dates, and mangoes.

3500 BCE - Cotton growing and cotton textiles quite advanced in India, and remained so until the 13th century.

3000 BCE - Farming in Ancient India: Most of the crop grown in the ancient times in the Indus Valley is likened to monsoon type crops such as cotton, sugarcane, rice wheat, barley, sesame, bananas, apples and dates.

200 BCE - King Dutthagamani in India has a large artwork of the Sacred Fig Tree (Buddha's tree) made of precious materials and placed in the Great Gold Dust Dagoba park and gardens. Cultivation and trade of coconuts between East Africa and India.

460 A.D. - Egg plants were cultivated in China and India. Portuguese introduced the grafting technique into Indian horticulture about A.D. 1550.

Crops

Pineapple (*Ananas comosus*) is indigenous to Brazil. The Portuguese introduced it into India in the middle of the sixteen century. In A.D 1578, Acosta mentioned that this fruit was grown profusely in western India.

Cashew nut (*Anacardium occidentale*) is a native of Brazil. Its red fruit the so-called apple, is acrid and to it is appended the nut like a bud. It is certainly a Portuguese introduction into India. Its earliest mention is by Acosta (A.D 1578), who found it in gardens in the city of Santa Cruz in the kingdom of Cochin.

Chillies (*Capsicum annum*) is a native of Brazil and Peru which has been introduced in the sixteen century as the ornament of Indian garden and soul of pickles.

- Portuguese introduced the *Allamanda cathartica* is a climber with beautiful yellow flowers. It was introduced into India from Brazil.
- Amaranth (*Amaranthus caudatus*) was introduced by the Portuguese into Malabar from Brazil.
- Guava is also a Portuguese introduction into India, possibly from Brazil.
- Sharifa (*Annona squamosa*) or custard-apple was introduced by the Portuguese into India in the sixteenth century. It grows wild in the Deccan Plateau, custard-apple is the bullock's-heart (*Annona cherimola*), a delicious fruit which grows in Karnataka and Bengal.
- Chiku (*Manilkara kauki*; Syn. *Achras zapota*) is a native of Mexico and its cultivation is spreading in India. Chiku is also a gift of the Portuguese to India.
- To India, Brazil gave two most beautiful ornamental plants, viz., Jacaranda mimosifolia, with violet-blue flowers, and solanum macranthum, the brinjal-tree with purple and white flowers.
- Portuguese introduced Amaranth (*Amaranthus caudatus*) into Malabar from Brazil.

2.39 VEGETABLE FARMING-FLORICULTURE-PERFUMES

2.39.1 Vegetable Farming

Kashyapa's Krishi-Sukta (800-900 A.D.) listed rice and other cereals as the first, pulses and other grains as the second, vegetables (including fruits) the third, and creepers and flowers etc., the fourth. Seeds of wheat, pulses, fruits, vegetables and condiments such as turmeric, cumin, black pepper, etc., also need

to be preserved for cultivation in the proper season. Kashyapa has advised four types of cultivation *viz.*, (i) rice, (ii) pulses, (iii) vegetables and (iv) creepers and flowers. The farmers should cultivate delicious vegetables like Jatika, Rasijatika, Valkika, Vana-vallika, Patolika, egg-plants, Savaka, pumpkin-gourd, Kalata, Kustumburu, Surana, Sakuta, and turmeric and ginger-both cultivated and wild-as well as various other luscious plants for the sake of cooking. In the writer's opinion these are the principal vegetables. In some countries the varieties of vegetables are different depending on their species, shape, taste and colour. The cultivators should grow vine, Indian spikenard, cardamom, etc., in their respective regions of cultivation. A Wiseman should grow indigenous vegetables on low as well as high land according to the season and country after learning the method of cultivation. Of the cultivable commodities the varieties of paddy occupy the first place, the pulses the second, and the vegetables the third. In the fourth place come ghee, milk, curds, etc. These four kinds of products comprise the entire foodstuff. This stuff promotes the happiness of all the gods and is the means of sustenance of the whole humankind. This gives nourishment, health and long-life and was created by Brahma at the beginning of creation all over the earth.

In the spring, the summer and at some places in the dewy season the cultivation of vegetables is sure to bring rich reward. The seeds of the egg-plant, *Valli*, *Jatika*, pepper, *Savaka* etc., dried in the sun should be sown in ploughed field for the sake of sprouting. The seeds of the egg-plant, etc., dried in the sun, should be sown in the soil dressed with cow-dung, etc., for sprouting. They should be regularly watered and then covered with the straw-shed. In three days the sprouts appear in the depressions where the seeds were sown. After twenty days when the sprouts have taken firm roots, the wise cultivator should transplant them in a properly ploughed field. Watering the roots at that very time promotes the life of the plants.

The cultivation of vegetables is good in low land in the summer and not in the rainy season. It is successful in other seasons also. In the same manner the bulbs of *Sakuta*, *Surana* and turmeric should also be implanted in hollow depressions or in a bed of hot soil and they will thrive. In this way, the cultivation of creeping plants is manifold. Pumpkin-gourds, wild pumpkins, cardamom, spikenard and *agavalli* (Piper Betel) may also be grown on high land. Of *patolika*, egg-plant, *Saka* (leafy vegetables), and *Savaka*, the unripe young fruit is tasteful and is therefore, highly commended. He should cultivate, nourish and protect the various *sakas* (pot herbs), which are fit for eating, sucking and chewing.

The cultivators should after making depressions etc., in their various fields, cultivate seasonably in spring, summer, rains, autumn, dewy season and winter pot-herbs and other vegetables whose leaves, rind, flowers or bulbous roots are (edible and) delicious, nourishing and health-giving, and reap the rich fruit of their labourers. They should grow, seasonably and according to usage, instructions of former sages and the nature of the soil, cardamom, cloves, ginger, arecanut, betel plant, sugarcane, plantain trees and other life-promoting and beneficial herbs like the long-pepper in their field-beds or on high land (*i.e.*, wet or dry land) as the case may be. The Brahmanas, Ksatriyas, Vaisyas, Sudras, men of mixed castes, hunters and soldiers (*vim*) should all grow to their best efforts (*coriander*, *surana*, *valli*, pumpkin-gourd, and *Patolika*) in their own land of whatever sort it may be. Experienced cultivators carry out all the processes needed for the infixing of the seeds, weeding of the ill-growth and protection of the plants till the time of inflorescence, under their own supervision according to the traditional usage. Of these vegetables, leaves, flowers, fruit, unripe fruit or bulbous roots are taken for use either at the beginning of efflorescence, or in the middle or end of it, as the case may be. The king should also introduce balances with a beam and scales made of bronze or brass for the weighing of vegetables. Whatever help in the cultivation of food grains and vegetables, etc., and in the procurement of oils, cloth, etc., is recommended by former sages in their treatises that the king should render for the

happiness of his subjects in every village and every house as well as for his own welfare. He should promote agriculture by regulating cultivation, sowing, etc., according to time and season, and cold and hot places.

Betel stimulates love, reveals-physical charm, enhances personal magnetism (*i.e.*, makes one attractive), gives good smell to the mouth, strengthens the body, and dispels diseases arising from the vitiation of phlegm. It also bestows many other advantages. Betel leaves are used with a moderate dose of lime imparts red-colour (or love); an extra quantity of betel-nut spoils colour (or passion); excessive lime produces bad smell in the mouth; while an extra quantity of betel-leaf, pleasant smell. At night it is beneficial to have an over-dose of betel-leaf white by day, of areca-nut, to change this order is a mere farce of betel-chewing. When betel-leaf is made fragrant by means of kakkola (*Luffa echinata*), areca nut the fruit of Levali (*Cicca acida*) and Jatiphala (*Myristica fragrans*), it makes one happy with the joy of amorous odour.

Quest for spices (A.D. 1498–1580): Europeans had to pay extortionate prices for species, particularly pepper, which not only made their food tasty, but was also used as a preservative for meat. Pepper was also used in wine and pastry.

2.39.2 Floriculture in Ancient India

The divine character of the trees has been depicted in a number of seals, sealing potteries, potsherds and some rock paintings as archeological evidence of the Mohen-jo-daro and Harappa period (3500–1750 B.C.). A few trees such as pipal or asvatta (*Ficus religiosa*), neem (*Azadirachta indica*), katha or khadira (*Acacia catechu*) and jhand or sami (*Prosopis cineraria*) were held sacred by the ancient people of the Indus Valley. There are vivid descriptions of trees in the Rigveda (3700–2000 B.C.). Methods of plant multiplication by seed and vegetative means were prevalent and find mention in the Vedas, Arthasasthra and Brhat Samhita. Plants were also featured in personal adornment and beautification of the home. Girls wore flower to Champaka (*Michelia champaca*) and jasmine in their hair and those of Siris (*Albizzia labbek*) in their ears. They made garlands of many kinds of flowers and painted their foreheads and cheeks with sandal paste obtained from Santalam album. Poet Kalidasa has made frequent references to these in his writings. In his Ritusamhara, Kalidasa gave charming descriptions of indigenous beautiful trees of India with flowers in different months. According to Vatsyana all big houses and palaces of kings had to pleasure garden—vrksavatika and pushpavatika. Among the trees, one of the most beautiful was the red flowered Saraca indica popularly known as Asoka. It was said that Sita was confined by Ravana in a grove of asoka trees. Another favourite tree of those days was Kadama (*Anthocephalus cadamba*) and its flower appears in golden balls. It was closely associated with the life of Lord Sri Krishna.

Of the climbers, Madhavalata (*Hiptage madhavalata*) received frequent mention in Kalidasa's play (5th century) and among sweet scented shrubs the mask-mallow (*Hibiscus abelmoschus*) and the garland flower (*Hedichium coronarium*). Description of flowers and gardens and the garland flower (*Hedichium coronarium*). Description of flowers and gardens had been presented in ancient Sanskrit classics like Rig Veda (3000–2000 B.C.), Ramayana (1200–1000 B.C.) and Mahabharata (500 B.C.). Other Sanskrit books of early days written by Shudraka (100 B.C.), (Asvaghosha (100 A.D.) and Sarnghara (1283–1301 A.D.) also mentioned about flowers and gardens. Among the flowers the sacred lotus (*Nelumbo mucifera*) was the most important and numerous references to it occur in Sanskrit literature. In the days of Mohen-jo-daro, lotus blossoms were wreathed over the head of Sun-God.

After rise of the Mauryas in the 4th to 5th century B.C., there has been vast secular literature and texts both vedic and post-vedic like vedas Brahmanas, Aranyakas Upanishads sutras smritis Mahakavyas puranas Buddhists texts (Jataka) and jain literature (Sutras) the sagas of the Upanishads have described

the Cosmic Tree rooted in the Brahman the ultimate whose branches are space, wind, and earth the cosmic tree is the world mother the goddess of nature which have been a part of flock cult in Hindu mythology. Kalpavarska is mentioned in Ramayana, Mahabharata, Jatakas, Divyavadana and the Jain sutras. In Brahmanical religion, vata (*Ficus benghalensis*) was identified with Shiva asvatha (*Ficus religiosa*) with Vishnu lotus with Surya (Sun) and nine leaves of nine trees (navatatrika) with nine different aspects of Durga. The art of gardening and kinds of gardens were described by Sarangdhara (1300 A.D.) and Vatsyayana (300–400 A.D.) respectively. Vatsyayana (A.D. 300–400) has also rendered interesting accounts of four kinds of gardens namely pramadodyam udyan vrishavatika and nandanvana. The science of plant life. (Vrikshayurveda) on arbori-horticulture and usefulness of trees and gardens were well-known in ancient India. In the Ramayana mention is made of Ashokavana or Panchavati, in which Sita was held captive Ashoka tree (*Saraca asoca*) were predominant in this garden. In the Panchavati, five trees were planted. Asvattha (*Ficus benghalensis*) on the west amla (*Embllica officinalis*) on the south and the Ashoka (*Saraca asoca*) on the south-east. A description of the layout of gardens and parks and artificial lakes in the city of Indraprastha is given in the Sabha-Parva of the Mahabharata. The association of Lord Krishna with the Kadamba tree (*Anthocephalus indicus*) is well known.

During the Buddhist period gardens were laid out around the monasteries and stupas and there were beautiful gardens in Nalanada the Taxila. It is said that Lord Buddha was born under the papal tree in a garden. The planting of roadside avenue trees (margeshuvriksha) was an important contribution of the king Asoka (233 B.C.). He was the first king in Indian History who encouraged Arboriculture and adopted it as a state policy. Mathura sculptures of Kashi period-depicted Kadamba tree (*Anthocephalus cadamba*), Champaka (*Michelia champaca*), *Mesua ferra* and *Ixora aborea*.

The Hindus were so fond of ornamental plants that some of them were actually worshipped. Besides Asoka (*Saraca indica*), Padma (*Nelumbo nucifera*) and tulsi (*Ocimum sanctum*), the pipal (*Ficus religiosa*) and banyan were given a very high place. The tree and Buddha Gaya under which Lord Gautama Buddha attained enlightenment, was a pipal, its branches were taken far and wide and planted to be given rise to new trees. The life of Lord Buddha (56 B.C.) was intimately associated with numerous trees. The art of gardening was spread to neighbouring east from India with preaching of Lord Buddha. The trees which were associated with Lord Buddha are Sal (*Shorea robusta*), Asoka (*Saraca indica*) and plaksha (*Butea monosperma*). Concept of identifying trees with gods and goddesses and threats and punishments against the destruction of useful trees helped to save the trees and flora which is a remarkable contribution of our ancient people. In Ramayana stated "I have not cut down any fig tree in the month of Vaisakha why then does the calamity befall me". Felling of trees as an offence has been mentioned in several old texts like Kautilya's Arthashastra, Agni Purana, Varsha Purana Matsya Purana and Buddhist and Jain literature. During the Mughal period (16th and 17th centuries A.D.) and the British period (18th and 19th centuries) several ornamental plants were introduced into India. Indian native flora has made significant contributions to the gardens of the world and also to the improvement of a few flowers like orchids and Rhododendrons.

A. Mughal Period

The Mughals in India introduced the concept of developing a garden in an enclosed space during 16th and 17th centuries. Babur mentioned in the Baburnama some indigenous ornamental trees like hibiscus (*Hibiscus rosasinensis*), oleander (*Nerium indicum*), Keora (*Pandanus odoratissimum*) and white jasmine. He is credited with the introduction of scented Persian rose in India. Babur (1483–1530), the Mughal emperor had established gardens in Persia and India. Akbar the Great (1556–1605), the Mughal

emperor of India was the garden lover. Abu-i-Fazi provided a list of 21 fragrant flowering plants along with flower colour and season of flowering in *Ain-i-Akbari*. He also gave another list of 29 plants with flowers notable for their beauty. From the *Tuzuk-i-Jahangiri*, it appears that Jahangir was familiar with nearly all important fragrant plants of India like *Michelia champaca*, *Pendanus odoratissimum*, *Mimusops elengi*, and *Jasminum officinale*. Mughal gardens were developed in Agra, Delhi, Pinjore (near Simla), Srinagar, Kashmir and a few places during the 16th and 17th centuries A.D. The most important Mughal gardens are the Taj Mahal Garden Agra (1654 A.D.); Shalimar and Nishat Gardens, Srinagar, Pinjore Gardens, Pinjore and the Garden at Hamayun's tomb, Delhi the rose was introduced into our country via the port of Bussorah by Babur in around 1526. Jahangir and Nurjehan were ardent lovers of the rose and encouraged rose growing in gardens. Apart from planting garden. Jahangir popularized *char-chenars* *i.e.*, planting four *chenars* at the corners of a square, so that there may always be shade at the centre. The most important plants the famous Shalimar Bagh in Srinagar were the majestic China tree (*Platanus orientalis*), the Cyprus (*Cupressus sempervirens*) and the weeping willow (*Salix babylonica*) and flowers like rose narcissus daffodil, iris, lilies tulip and carnation. The Arabs terraced the slopes with vineyards. The Arabs specialized in the culture of *data-palm*. According to Swindle, the *data-palm* produces more well mineralized, highly flavored and nutritious human food per acre than any other temperate zone crop. While it has its feet in running water, its head is in the fires of heaven. Information on agriculture and horticulture especially gardening of Arabs could be obtained from the book '*Abu Zakariya*' written by Yahya bin Muhammad. Abu Zakariya says that all garden doorways should be flanked by clipped evergreens, that cypresses should be used to line paths and grouped to mark the junctions of paths. He objected to the mixing of evergreen with deciduous trees. Plants named in his text include lemon and orange trees, pines and most of our common deciduous trees, cypresses, oleander, myrtle and rose as the only flowering shrubs, violets, lavender, balm, mint, thyme, marjoram, iris, mallow, box and bay laurel. He lays much stress on aromatics, as, indeed, did all the Islamic gardeners. His climbing plants are vines, jasmines and ivy. The *mahua* (*Madhuca indica*) tree bears fruit twice a year and from its kernels they make oil, which they use for lamps.

Betel vines - Ibn Battuta also saw betel vines in Kerala. He states, Betel-trees are grown like vines on cane trellises or else trained up *coco-palms*. They have no fruit and are grown only for their leaves. The Indians have a high opinion of betel, and if a man visits a friend and the latter gives him five leaves of it, you would think he had given him the world, especially if he is a prince or notable. A gift of betel is a far greater honour than a gift of gold and silver.

B. European Period

Missionary priests, Englishmen, Portuguese, Amateur and professional gardeners from Europe, Asia and Africa, introduced a large number of plants into Indian gardens. Portuguese introduced *Agave americana* and *Allamanda cathartica*, which have now been naturalized throughout India. Several botanical gardens were established during 18th and 19th centuries in various parts of India, where indigenous and exotic plants were introduced and maintained. Roxburgh, the father of Indian Botany, was the first Botanist to adopt the Linnaean system of binomial nomenclature in relation to the plants of India. His pioneering work, *Flora indica*, *Plantae coromandelianae* and his portfolio of paintings of 2,382 plants mainly the work of Indian artists formed the basis of Hooker's '*Flora of British India*'.

Portuguese control the spice trade in the Indian Ocean during 1497 A.D. The term '*herbal*' was put in use in 1516 as per the Oxford English Dictionary. Robert Fortune (1852) sent tea plants from China to Indian Himalayas. *Cinchona* trees (for quinine) sent from Kew NBG to India in 1861. One of the important missionaries who introduced a number of exotic plants was Dr. Firminger, an Englishman

who wrote a book on gardening giving descriptions of various species of flowers in 1863. The book entitled "Firminger's manual of Gardening in India is an authoritative reference book on ornamental flowering plants even today.

With the establishment of Government Botanic Gardens by the British rulers during 18th and 19th centuries such as Lalbagh Botanical Garden, Bangalore (1760); the Government Botanic Garden, Saharanpur (1779); the Indian Botanic Garden, Sipbur Calcutta (1783); the Lloyd Botanic Garden, Darjeeling (1878) and the Government Botanic Garden, Ooty (1884), numerous economic plants as well as ornamentals were introduced in these gardens. Among the noteworthy introductions of that period are the mahogany (*Swietenia mahogany*) from Jamaica in 1795 and the Giant Amazon lily, *Victoria regia* from Sipbur gardens. Joseph Hooker brings 65,000 species of plants from India to Kew NBG in 1851. *Grevillea robusta* and *Araucaria excelsa* in 1857 and *Amherstia nobilis* in 1859 were introduced in the Lalbagh Botanical Garden, Bangalore. In the Government Botanic Garden, Saharanpur, *Canna glauca*, *Jatrophia multifida* and few other plants were introduced in 1817. *Bougainvillea spectabilis* was introduced by the Agni-Horticultural Society, Calcutta in 1858 from South Africa. The Lalbagh Botanical Garden, Bangalore introduced flower seeds from the Royal Botanical Garden Kew (England) in 1864.

2.40 PERFUMES

India has a perfumery tradition that dates back to over 5,000 years to Indus Valley civilization. In the excavations of Harappa and Mohanjodaro, a 'water distillation still' and 'receiver' have been recorded whose shape resemble to the 'deg' and 'bhabka' currently used by 'attarss' (traditional perfumers) of Kannauj in India. There was competition in the preparation of aromatic essence. The roots, flowers and leaves were used in perfumery. The Sanskrit Encyclopedia 'Manasollasa' composed by Someshwara in A.D. 1127 deals with the blending of perfumes, which were used in royal baths and for the rituals and worship. The Ain-i-Akbar (17th century) provides a list of twenty one fragrant flowering plants along with season and colours.

A. Preparation of Perfumes (Brhat Samhita)

The word 'yukti' means combination and composition. Perfumes and scents are manufactured for the benefit of royal personages and inmates of harems. All these things show that the level of scientific and industrial enterprise was pretty high in ancient India. In fact civilization grows if people desire increases for a happier livings, which in turn finds new avenues of getting luxury goods.

B. Hair Colouration

Cook the grains of Kodrava (*Paspalum scrobiculatum*) in sour gruel or vinegar in an iron dust and make a fine paste. After washing the hair with sour gruel (or vinegar) apply this paste to the head. Then, covering the head with green (juicy) leaves, remind for six hours. Thereafter remove the paste from the head and apply a paste of myrobalan (*Embllica officinalis*). Cover it again with green leaves and retain it for another six hours. On being washed, the hair will become black.

C. Royal Head-bath

A scented water fix for the washing of kings' head is prepared with equal quantities of woody cassia, coctus (*Saussurea lappa*), Renuka (*Piper aurantiacum*), Nalika (*Hibiscus cannabinus*), Sprkka (*Bryonopsis laciniosa*) Rasa or Bola (*Commiphora myrrha*), Tagara (*Valeriana wallichii*), Valaka (*Aprorosa lindieyana*), Nagake-sara (*Mesua ferrea*) and Patra (*Laurus cassia*). Betel stimulates love,

gives good smell to the mouth, improves digestion and dispels diseases arising from vitiation of phlegm. Betel leaves used with moderate dose of lime imparts red colour (or love); extra quantity of betel nut spoils colour or passion; excessive lime produces bad smell in the mouth; while an extra quantity of betel-leaf produce pleasant smell. At night, it is beneficial to have an over dose of betel leaf, while by day, of arecanut. To change this order is a mere farce of betel chewing.

D. Perfume from Roses

Here is an account in Jahangir's own words about the famous rose scent, **Jahangiri**: "This itr (*i.e.*, Jahangiri itr- so called otto of roses) is a discovery which was made during my reign through the efforts of the mother of Nur-Jahan Begam. When she was making rose water a scum formed on the surface of the dishes into which hot rose water was poured from the jugs. The scum was collected. It is of such strength in perfume that if one drop be rubbed on the palm of the hand it scents a whole assembly and it appears as if many red rosebuds had bloomed at once. There is no scent of equal excellence to it. It restores hearts that have gone and brings back withered souls. In reward for that invention I presented a string of pearls to the inventories. Salima Sulthan Begam (may the lights of God be on her tomb) was present, and she gave this oil the name of "its-i-Jahangiri".

2.41 MEDICINAL PLANTS AND THEIR RELEVANCE TODAY

The World Health Organization (WHO) estimated that 80% of the population of developing countries still relies on traditional medicines, mostly plant drugs, for their primary health care needs. Also, modern pharmacopoeia contains at least 25% drugs derived from plants. Many other are synthetic analogues built on prototype compounds isolated from plants. Demand for medicinal plant is increasing in both developing and developed countries due to growing recognition of natural products, being non-toxic, having no side-effects, easily available at affordable prices. There has been resurgence in the consumption and demand for medicinal plants. These plants are finding use as pharmaceuticals, nutraceuticals, cosmetics and food supplements. According to an all India ethno-biological survey carried out by the Ministry of Environment and Forests, Government of India, there are over 8000 species of plants being used for medicine in India.

2.42 THE SIDDHA SYSTEM OF MEDICINE

The Siddha system of medicine owes its origin to the Dravidian culture, which is of the Pre-vedic period. An examination of the ancient literature would reveal that the vedic Aryans owed allegiance to the cult of Shiva and the worship of the phallus (linga), which was later on absorbed by, and incorporated into the Vedic culture. The Shiva Cult is associated with its medical counterpart, the Siddha system of medicine, which is mainly therapeutic. Mercury, sulphur, iron, copper, gold, bitumen, white, yellow and red arsenic and other materials as well as vegetable poisons are extensively used in the pharmacopoeia of the Siddha tradition. The Siddha system of medicine is prevalent in the Southern States of India, Sri Lanka, Malaysia, and Singapore, where the Dravidian civilization was documented. In the North of India, the Siddhar-Kalpa system (Siddha means one who has attained immortality and Kalpa means panacea) is known as Tantric Science. Siddha Science considers nature and man as essentially one. One who knows the anatomy of nature and its five elements knows well the anatomy of men. Nature is the foremost physician. The Tamils who are inhabiting the Southern peninsula of the sub-continent of India have an impressive and venerable past, as ancient as that of perhaps the Egyptians. They undertook a systematic study of nature and its elements and from what they were able to grasp, they had developed a highly systematized medicine, which is now known as Siddha system.

It is well founded on the basic principles of nature and its elements offer a careful and thorough study of the human system.

A. Origin of Siddha Medicine

Siddha system is one of the oldest systems of medicine in India. The term 'Siddha' means achievement and the 'Siddhars' were saintly figures who achieved results in medicine through the practice of Yoga. Eighteen 'Siddhars' seem to have contributed towards the development of this medical system. Siddha system's literature is in Tamil and it is practiced in Tamil speaking parts of India. The system is also called Agasthiyar system in the name of its famous exponent sage Agasthya. A number of medical works of this system are ascribed to him but it may be difficult at this time to say the exact number that can be credited to him. This system of medicine developed within the Dravidian culture, which is of the pre-vedic period. The Siddha system is largely therapeutic in nature.

B. The Siddhars

The ancient Tamils in their quest for knowledge for longevity developed two ways by which man can achieve mastery over nature. One is the Yogic way and the other is through medicines. The persons who dedicated themselves to this task were themselves great yogis known as Siddhars. Hence the system of medicine propounded by them came to be known as Siddhars system of Medicine. This system can be traced to the prevedic period. Siddhar, a Tamil word that is derived from its root 'chit' means perfection in life or heavenly bliss. It generally refers to eight kinds of supernatural powers attainable to man. Siddhars are the persons who had attained such miraculous powers attainable to man. The persons who had attained such miraculous powers in life are known as Siddhars. They are men born with great talents who lived thousands of years ago in Tamil country, who by their devotion and search for truth, achieved perfection in their life time.

C. Ancient Siddha Medical Works

The earliest mention the use of medicinal plants is to be found in Thirumular Thirumantiram-Ennayiram, Tholkappiam and the ancient Tamil works of Sangarm Literature, which are believed to have been written thousands of years before the Christian era. There are now more than 500 works in Tamil dealing with various subjects such as science of life, nature of universe, astronomical data, cosmic dance, atomic theory, space travel, alchemy, 'Kaya Kalpa' medicine, etc.

D. The Neem Tree

The Neem tree was regarded as sacred in Mohen-jo-daro Civilization. In the annals of the ancient Siddha System of Medicine, the first medicinal plant mentioned as well as found a place, in ancient Tamil literature is Margosa or Neem. This has been used by Tamils from time immemorial as a deterrent for smallpox and other infectious diseases and also considered to possess powers to ward off evil spirits. Perhaps they were aware of the germicidal action and the medicinal properties of the Margosa, Tirumular, the great siddha is said to have been in deep penance for several thousands of years before the Christian Era in eternal bliss under a sacred pipal tree.

E. Basis of the Siddha System

According to Siddha medical science the universe consists of 5 elements. Earth, Water, Fire, Air and Ether which correspond to the five senses of the human body. Man consumes water and food, breathes the air and then maintains the heat in the body. He is alive because of the life force given by ether. The earth is the first element, which gives fine shape to the body, including bones, tissues, muscles, skin, hair etc. Water is the second element representing blood, secretions of the glands, vital fluid etc. Fire

the third element that gives emotion, vigour and vitality to the body. It also helps digestion, circulation and stimulation besides respiration and the nervous system. Above all other is the characteristic of man's mental and spiritual faculties. A suitable proportion of these five elements in combination with each other, produces a healthy person. These elements are divided into two halves, namely physical and subtle. And this subtle part is further sub-divided into two equal parts of which one is retained as such and the other part is again subdivided into four equal parts. This is what is known in Siddha system of Medicine as the theory of Panchikarnam (Fivefold combination). It is fact the functioning of the five elements in the human body. The ideal of the unification of energy and matter and the synthesis of the various phenomena of sound, light, heat, etc., which modern science has been endeavouring to establish were achieved by the ancient Siddhas, when modern equipments was not available for research. Siddhas also held that he who knows the secret doctrine of the five elements, could change a baser metal into gold. And Siddhas alchemy is based on this theory.

Kalpa Treatment - Ancient Siddha devoted time in finding out suitable remedies rather than describing the causes of a disease in detail. The scope of 'Kaya Kalpa' treatment is two-fold; one is to cure degenerative diseases and the other is to prolong the life span. Kalpa serves as an anti-degenerative elixir—that can cure cancer and heart diseases is itself rejuvenation.

F. Culture and History of Siddha Medicine

The original home allotted to mankind by the Creator was in the temperate and fertile region of the East and pointedly in India. It is from here that the human race began its culture and career. India may, therefore, be safely stated as that the first country from which human culture and civilization originated and spread. According to Indian history prior to Aryans migration, the Dravidian was the first inhabitant of India of whom the Tamilians were the most prominent. The Tamilians were not only the earliest civilized but also those who may more considerable progress in civilization than any other early people. The languages of India were divided into two great classes, the northern with Sanskrit as the pre-pondering element and the southern with Dravidian language as independent bases. The science of medicine is of fundamental importance to man's well being and his survival and so it must have originated with man and developed as civilization. It is, therefore, rather pointless to try to determine the exact point of time to which the beginning of these systems could be traced. They are eternal; they began with man and may end with him. The Siddha was flouriest in south and Ayurveda prevalent in the north. Instead of giving the name of any of individual as the founder of these systems our ancestors attributed their origin to the creator. According to the tradition it was Shiva who unfolded the knowledge of Siddha system of medicine to his consort Parvati who handed it down to Nandi Deva and he the Siddhars. The Siddhars were great scientists in ancient times.

According to tradition, the origin of Siddha system of medicine is attributed to the great Siddha Agastiyar. Some of his works are still standard books of medicine and surgery in daily use among the Siddha Medical practitioners. The science of medicine is of fundamental importance to man's well being and his survival, and so it must have originated with man and developed as civilization advanced. It is therefore rather pointless to try to determine the exact point of time when any system of medicine was evolved and codified. A system of medicine is not a discovery but a gradual evolution during successive periods of history. It owes its progress to great men, who have not only enriched the science, but also society and civilization as a whole.

There are two ancient systems of medicine in India, the Siddha that flourished in the South and the Ayurveda prevalent in the North. Instead of giving the name of any one individual as the founder of either system, our ancients wisely attributed their origin to the Creator. According to tradition, it was Shiva who unfolded the knowledge of Siddha system of medicine to his consort, Parvati, who handed

it down to Nandideva and he, to Siddhars. Therefore, it is called 'Saiva Sampradayam' (tradition of Shive), or 'Siddha Sampradayam'. In the case of Ayurveda it was Brahma, the Creator of the Universe, who taught the science to Prajapati, he to Aswini Devatas and they, in their turn, to Atreya etc. So this tradition is called the Brahma or Arsha Sampradaya (the tradition of Rishis). The inference to be drawn from these traditions is that, there is no exact point of time to which the beginning of these systems could be traced. They are eternal, without a beginning or end; they began with man. The Tamils have a distinct civilization, which is not disputed by historians. The recorded history of the Tamils is thousands of years old. Apart from the literature of the first, the middle and the last Sangam periods, which bears ample testimony to the extent of Tamil civilization and its eminence, mention is made even in contemporary Sanskrit literature about Cholas, Pandiyas and Cheras and their kingdoms. A civilized society must naturally have had a system of medicine, which catered to the health needs of its people. This was the Siddha system. The term 'Siddhi' means 'achievement' and the Siddhars were men who achieved certain results in medicine, as well as in yoga or tapas. The results in medicine were achieved by the Siddhars through their mental powers, they bequeathed to their 'Chilas' or pupils, who preserved and propagated the science. Eighteen Siddhars seem to have existed. They should have lived at different periods and bequeathed their experiences in medicine and yoga to posterity. The names of these eighteen Siddhas differ from one source to another. It is not necessary to dogmatise which of these enumerations is correct. Some of the Siddhas, for example, Kapila and Kakabujanda have written treatises both in Tamil and in Sanskrit. It is possible that the originals were written in Tamil and that they were translated into Sanskrit later. The following is the list of eighteen Siddhas according to one recession: 1. Nandi 2. Agasthiyar 3. Thirumular 4. Punnakkeesar 5. Pulasthiyar 6. Poonaikannar 7. Idaikadar 8. Bogar 9. Pulikai Isar 10. Karuvurar 11. Konkanavar 12. Kalangi 13. Sattainathar 14. Azhuganni 15. Agappai 16. Pambatti 17. Theraiyar and 18. Kudhambai. The names like Bogar, Idaikadar and Theraiyar are of recent origin and these Siddhars lived probably in the middle ages. There are also authors of Siddha treatises like Sattaimuni, Yugimuni, Macha Muni, Kakabusundar etc., whose works are available in parts at the present day and are being used.

G. Important Tamil Books in Siddha Medicine

Siddha Vaidya Thirattu, Therayar Maha Karisal, Brahma Muni Karukkadia 300, Bhogar 700, Pulippani 500, Agasthiyar Paripuranam 400, Therayar Yamagam, Agasthiyar Chenduram 300, Agasthiyar 500, Athmarakshmrutham, Agasthi Pin 80, Agasthiyar Rathna, Hurukkam, Therayar Karisal 300, Veeramamuni Nasa Kandam, Agasthiyar 600, Agasthiyar Kanma Soothiram, 18 Siddhar's Chillari Kovai, Yogi Vatha Kaviyam, Therayar Tharu, Agasthiyar Vaidya Kaviyam 1500, Bala Vagadam, Chimittu Rathna (Rathna) Churukkam, Nagamuni 200, Agasthiyar Chillari Kovai, Chikicha Rathna Deepam, Agasthiyar Nayana Vidhi, Yugi Karisal 151, Agasthiyar Vallathi 600, Therayar Thaila Varkam, Siddha Formulary of India (Part I).

The Rigveda (5000 years B.C.) mentioned 67 medicinal plants, Yajurveda 81 and Atharvaveda (4500-25000 B.C), 290 species. Later the Charak Samhita (700 B.C.) and Sushrut Samhita (200 years B.C) have described properties and uses of 1100 and 1270 plants respectively, in compounding of drugs and these are still used in classical formulations in the Ayurvedic system of medicine.

H. Timeline of Indian Medicine

1000 B.C.	–	Atharva Veda.
600 B.C.	–	Codification of medical knowledge into Ayurveda.
400 B.C.	–	Caraka Samhita by Caraka.

400 B.C.	–	Susruta Samhita by Susruta.
700 A.D.	–	Ashtanga Samgraha by Vagbhata.
700 A.D.	–	Ashtanga Hridya Samhita by Vagbhata.
800 A.D.	–	Rasaratnakara by Nagarjuna.
900 A.D.	–	Rug Vinishchaya by Madhakara
1000 A.D.	–	Siddha Yoga by Vrinda.
1000 A.D.	–	Nava Nitaka by Navanita.
1300 A.D.	–	Sharangadhar Samhiti by Sharangadhar.
1550 A.D.	–	Bhavaprakasha by Bhava Misra.
1563 A.D.	–	Garcia da Orta's Coloquios dos simples e Drogas e cousas medicineis da India (A.D 1563) includes description of many Indian medicinal plants.
1591 A.D.	–	Christophoras Acosta's Aromaticum et medicamentorum in Orientali India nascentium liber and Historia Natural R moral de las Indias scuilla (Barcelona, A.D. 1591) are important works on medicinal plants of India.

I. Distribution of Medicinal Plants in Tamil Nadu

Analysis of habits of medicinal plants indicates that they are distributed across various habitats. One third are trees and an equal portion shrub and the remaining one-third herbs, grasses and climbers. A very small proportion of the medicinal plants are lower plants like lichens, ferns, algae, etc. Majority of the medicinal plant are higher flowering plants. The State of Tamil Nadu is endowed with a very rich flora. Due to the various physiographic features and physiognomic factors, different types of vegetation exist in the state: 1. Coastal vegetation, 2. Island vegetation and 3. Vegetation of hills and mountains comprising of:

1. Dry deciduous forests
2. Moist deciduous forests
3. Semi-evergreen forests
4. Wet evergreen forests
5. Sholas (Southern montane wet temperate forests)

The altitude varies from sea level to 2637 m including the well known mountain ranges—the Nilgiri, the Anamalais and the Cardamom hills which harbours different types of ecological niches, ecosystem and innumerable medicinal plants. A few ethnic tribes like the Irular, Kaanikkara, Karumpar, Palliyan, Paniyar, Sholagar, Thodar and others dwell in these ecosystems and still depend on naturally occurring or cultivated from the state. Out of this, it is found that 1474 are medicinal plants. A total number are found to be used in Siddha system of medicine, which is commonly practiced throughout the state.

Tampcol has two medicinal farms, one in Chennai city at Arumbakkam and at Valavandinadu, Kolli hills, Namakkal district. In Chennai farm six varieties of medicinal plants are cultivated in five acres to meet the fresh herb requirements for the production of herbal hair tonic, other medicated oils and also supplied to pharmacy at Arignar Anna Govt. Hospital for Indian medicine and Homoeopathy, Chennai. Another 150 varieties of medicinal plants are maintained in the parks as reference material. The farm is also visited by the students of all systems of Indian Medicine. Leading practitioners of Indian

Medicine also make use of this farm as their reference for medicinal plants. This farm is very popular and has contributed for herbal awareness in Chennai City. The farm participates in the exhibitions conducted by Educational Institutions, Trade fairs and seminars/conferences in the city. The public is also encouraged to buy the medicinal plants at low prices to enhance the importance and awareness of herbal medicines.

The Kolli Hills medicinal farm is situated in Valavandinadu at the altitude of 3600 ft. The land is undulating with rocky slopes. Out of 105 acres year-marked, the corporation has developed 55 acres and cultivating a dozen species of medicinal plants on large scale and another 50 varieties which includes trees, climbers, perennials are cultivated on bunds, hedges, fence line etc., as per suitability of the species. Further, the farm has a large nursery in which seedlings/saplings/cuttings/graftings are raised for own cultivation and to supply to the government institutions concerned and also to progressive farmers in the state and outside.

J. Raw Drugs Trading

The corporation is handling 400 varieties of raw drugs of plant, metal/mineral, animal and marine origin for the production of its own products and to supply to four government pharmacies of ISM in the state and also for the outside sales. The corporation is experienced in the All India raw drug trade and can source raw drugs for domestic and overseas markets.

K. Tampcol Products

Tamil Nadu Medicinal Plant Farms and Herbal Medicine Corporation Ltd. (TAMPCOL) was established in 1983 by the Government of Tamil Nadu at Chennai. The corporation has been manufacturing 50 medicines of Siddha, Ayurveda and Unani systems and supplying to all the ISM wings in PHC's/Dispensaries/Hospitals and Taluk/District hospitals in the state of Tamil Nadu apart from supplying to TNEB dispensaries and CGHS dispensaries in Chennai city. The products are also sold in the open market through dealers and Tampcol's outlets in Chennai and Palayamkottai. The particulars of medicinal plants cultivated in Tamil Nadu are presented in Tables 18, 19 and 20.

Table 2.12. Medicinal Plants under Cultivation in Tamil Nadu

<i>Sl.No.</i>	<i>Botanical name</i>	<i>Tamil name</i>	<i>Trade name</i>
1.	<i>Piper longum</i>	Thippili	Long pepper
2.	<i>Alpinia speciosa</i>	Sitrathai	Galangal
3.	<i>Centella asiatica</i>	Vallarai	Gotucola
4.	<i>Bacopa monnieri</i>	Neer birammi	Birammi
5.	<i>Phyllanthus amarus</i>	Keelanelli	Phyllanthus
6.	<i>Eclipta alba</i>	Vellai karisalai	Brhingraj
7.	<i>Phylla nodiflora</i>	Poduthalai	–
8.	<i>Wedelia calandulaeae</i>	Manjal karisalai	–
9.	<i>Ocimum sanctum</i>	Thulasi	Thulasi
10.	<i>Ocimum kilimanjariacum</i>	Karunthulasi	Krishna Thulasi
11.	<i>Ruta graveolens</i>	Aruvatha	Burke-Sadaf
12.	<i>Desmodium gangeticum</i>	Orilai	Desmodium
13.	<i>Uraria picta</i>	Moovilai	Uraria
14.	<i>Pogostemman patchouli</i>	Patchilai	Pogostemman

15.	<i>Acorus calamus</i>	Vasambu	Sweet flag
16.	<i>Adathoda zeylanica</i>	Adathoda	Adathoda
17.	<i>Vetiveria zynoides</i>	Vettiver	Vettiver
18.	<i>Gymnema sylvestre</i>	Siru kurunjan	–
19.	<i>Decalepis hamiltonii</i>	Malai nannari	Decalepis
20.	<i>Melina arborea</i>	Perungkumil	Kumbi
21.	<i>Embilica officinalis</i>	Nellikkai	Amla
22.	<i>Aegle marmelos</i>	Vilvam	Bel
23.	<i>Saraca asoka</i>	Asokam	Asok
24.	<i>Terminalia arjuna</i>	Marutham	Arjuna
25.	<i>Syzigium Jambolanum</i>	Naval	Jambolanum
26.	<i>Croton tiglium</i>	Nervalam	Jamal got
27.	<i>Michalia Champaka</i>	Senbagam	Champak
28.	<i>Syzigium aromaticum</i>	Elavangam	Cloves
29.	<i>Piper nigrum</i>	Milagu	Black pepper
30.	<i>Cinnamum tamala</i>	Elavanga pattai	Cinnamum
31.	<i>Myristica fragrance</i>	Jathikkai	Nutmeg
32.	<i>Steriospermum suaveolens</i>	Pathiri	Pata
33.	<i>Cichorium intybus</i>	Kasini	Kasini
34.	<i>Andrographis paniculata</i>	Nilavembu	Kalameg
35.	<i>Tinospora cardifolia</i>	Seenthil	Guduchi
36.	<i>Asparagus recimosus</i>	Thanneervittan kilangu	Asparagus
37.	<i>Psoralea corilifolia</i>	Karbogalarisi	Babchi

Table 2.13. Agrotech of Medicinal plants

S.No.	Botanical name	Trade name	Type and duration of crop
1.	<i>Centella asiatica</i>	Vallarai	Perennial Crop - 3 Months
2.	<i>Eclipta alba</i>	Vellai karisalai	Seasonal Crop - 3 Months
3.	<i>Wedelia calandulaceae</i>	Manjal karisalai	Perennial Crop - 3 Months
4.	<i>Ruta graveolense</i>	Aruvatha	Annual Crop - 1 Year
5.	<i>Alpinia speciosa</i>	Sittrathai	Annual Crop - 1 Year
6.	<i>Andrograpis paniculata</i>	Nilavembu	Seasonal Crop - 6 Months
7.	<i>Phyllanthus amarus</i>	Keelanelli	Seasonal Crop - 3 Months
8.	<i>Moranta arundunaecae</i>	Arrow root	Seasonal Crop - 1 Year
9.	<i>Cichorium intybus</i>	Kasini	Seasonal Crop - 5 to 6 Months
10.	<i>Solanum nigrum</i>	Manathakkalai	Seasonal Crop - 5 to 6 Months
11.	<i>Psorelia corilifolia</i>	Karbogalarisi	Seasonal Corp - 5 to 6 Months
12.	<i>Adathoda zeylanica</i>	Adathoda	Perennial Crop - 3 Months
13.	<i>Ocimum sanctum</i>	Thulasi	Seasonal Crop - 6 Months
14.	<i>Gymnima sylvastre</i>	Sirukurinjan	Perennial Crop - 1 Year
15.	<i>Bacoppa monnieri</i>	Neer Birammi	Perennial Crop - 3 Months

Table 2.14. Plants Cultivated and Exported from Tamil Nadu

S.No.	Botanical name	Trade name	Area of cultivation in Tamil Nadu
1.	<i>Gymnima sylvestre</i>	Gymnima	Dindugal, Kolli Hills, Tuticorin.
2.	<i>Centella asiatica</i>	Gotucola	Salem, Erode, Hosur.
3.	<i>Cichorium intibus</i>	Kasini	Ooty, Hosur, Kolli Hills
4.	<i>Eclipta alba</i>	Bhringraj	Trichy, Salem, Madurai
5.	<i>Coleus forskholii</i>	Forskholii root	Thiruvannamalai, Salem, Madurai.
6.	<i>Gloriosa superba</i>	Gloriosa	Salem, Krishnagiri, Moolanoor, Ottanchathiram, Sivakasi.
7.	<i>Cassia angustifolia</i>	Senna	Tirunelveli, Tuticorin, Virudhunagar.
8.	<i>Indigofera tinctoria</i>	Indigo	Viluppuram, Tindivanam, Vandavasi, Thiruvannamalai, Thiruvallur.
9.	<i>Ocimum sanctum</i>	Thulasi	Salem, Hosur
10.	<i>Ruta graveolense</i>	Burk-e-sathaf	Hosur, Ooty, Kolli Hills.
11.	<i>Decalepis hamiltonii</i>	Decalipis	Kolli Hills.
12.	<i>Phyllanthus amarus</i>	Phyllanthus	Thiruvallur, Salem, Hosur, Madurai.

L. Medical Education in Ancient India

Medicinal knowledge gained over trial and error over the thousands of years in India and neighbouring regions has been systematized thousands of years ago in a system of medicine called Ayurveda. Ayurveda is a Sanskrit word, derived from two roots: ayur, which means life, and Veda, knowledge. Knowledge arranged systematically with logic becomes science. During the due course of time, Ayurveda became the science of life. It has its root in ancient Vedic literature and encompasses our entire life, the body, mind and spirit. In ancient India, Medical education was available in the larger cities such as Taxila, Kasi (Varanasi) and Nalanda. Taxila situated about 20 miles west of Rawalpindi (now in Pakistan) was the most important seat of learning in ancient India dating from the sixth century B.C. It attracted students from all corners of India viz., from Rajagriha, Mithila, Kashi, Ujjain, Kuru, Koshala, etc. Its fame had spread far and wide in foreign countries; students from there were said to come here to learn. Nalanda was another center of learning, which flourished from the fifth to twelfth century A.D. The plant wealth of forest was utilized through 'Ayurveda' for the welfare of human beings. The most important trees extensively used in medicinal preparations were Neem (*Azadirachta indica*), Anola (*Phyllanthus officinalis*), Harra (*Terllinalia chebula*), Behda (*Termlinalia bellirica*), and Bael (*Aegle marmelos*). The city of Ayodhya was inhabited by a good number of vaidyas or physicians. Proficient and skilled surgeons known as 'salyakrt' (v. 28.6) existed at the time of Ramayana. Physicians accompanied royal well developed and surgeons were in special demand. Surgeons of the structure of the human body as can be inferred from the many anatomical terms used in the epic.

M. Siddha Education

There are two Government Siddha medical colleges with a total admission capacity of 150 students at the Under Graduate level. One at Palayamkottai with admission capacity of 100 and the other at Chennai with an admission capacity of 50. In addition to the above another 3 private Siddha medical colleges are also there in Tamil Nadu with an admission capacity of 30 students each. Admissions are purely on the basis of Common Entrance Test conducted by the Govt. of Tamil Nadu after 10+2. These

colleges are affiliated to Dr. MGR Medical University, Chennai. Both the Government colleges are having the facilities for post-graduate education with total admission capacity of 80 (Palayamkottai : 60 and Chennai : 20).

The Government has constituted the Tamil Nadu Medicinal Plants Board to address the issues connected with conservation and sustainable use of Medicinal Plants, cultivation of Medicinal Plants and export of such products. An international organization, called ICMAP (International Council for Medicinal and Aromatic Plants) was initiated and located in Paris, France. The Government of Tamil Nadu has established the National Institute of Siddha at Tambaram, Chennai. This institute has teaching facility in 6 Siddha subjects as mentioned below:

- *Siddha Maruthuvam - Pothu (General Medicine)*
- *Gunapadam (Pharmacology)*
- *Sirappu Maruthuvam (Special Medicine)*
- *Pillaippini Maruthvam (Paediatrics)*
- *Noi nadal (Pathology)*
- *Nanju nool (Toxicology)*

The Central council of Indian Medicine regulates the education of Siddha system in the country. Within the council, there is a separate education committee for this system. The education committee is charged to deal with all matters pertaining to Siddha education including the development of a detailed curriculum and syllabus both at under-graduate levels.

2.43 ROLE OF CATTLE AND OTHER DOMESTIC ANIMALS

A. Domestication of Animals

The raising of animals is as old as civilization itself, for, our common domestic animals were domesticated before the beginning of written history. Paleolithic man hunted animals for food and raiment; his successor, the Neolithic man, tamed and confined them. It was in the Neolithic or New Stone age that men first practiced agriculture, which included the raising of domestic animals. Carbon-14 testing of animal and plant remains showed the domestication of sheep at 9000 B.C. in northern Iraq; cattle in the 6th millennium B.C. in northeastern Iran; goats at 8000 B.C. in central Iran; pigs at 8000 B.C. in Thailand or asses, at 7000 B.C. in Jarmo, Iraq; and horses at 4350 B.C. in Ukraine. The domestication of sheep and goat took place in the pre-agricultural phase when nomadic man with the help of dog brought them under his control. Small ruminants like sheep and goat constituted the important dietary source of the early man. This was probably the first step towards secured food production in his adventurous life. The early man had the wisdom to distinguish between sheep and goat and their varying ecological requirements. The sheep is essentially a grass eater preferring protection of open woods. The goat is a browser preferring foliage of shrubs and trees and is content with sparse forest. To the early man, sheep and goat provided milk, meat and clothing. Sheep scored over the goat in respect of wool and quality of meat while goat provided more milk.

Animals like horses, elephants, camels, sheep, goats, bullocks, cows and buffaloes played vital role in the development of human civilization from early time. The large ruminants like cows and buffaloes were wild animals of the forest and they used to invade the fields of river valley civilization as crop robbers. The early men judged the utility of these animals for power (energy), food (milk and meat), manure (dung and urine) and hide (shoes and shields). These crop robbers were, therefore, captured and domesticated to meet the day-to-day needs of life.

B. Life Span of Animals

The life span of some animals mentioned by Shalihotra is given below:

Elephant	120 years
Horses	32 years
Cows	24 years
Asses and camels	25 years
Dogs	16 years
Jackals	25 years
Bees	14 days

C. Livestock in Agriculture

“When *Prajapati* created cattle, he made them over to the *Vaisya*; and if a *Vaisya* is willing to keep them, it must not be kept by any other caste.” (*Manu Samhita*). *Vaisyas* were primarily agriculturists, formed a wealthy and respectable section of the community and produced fine breeds of cattle. Agriculture, cattle rearing, trade and commerce constituted the four fold *vartha* or pursuits suitable for making fortune. Cattle rearing have been noted in the Epics as important and universal an occupation as farming in *Ramayana* and *Mahabharata*. The famous cow “*Kamdhenu*” (meaning producing according to desire) of *Bashistha* existed in *Mahabharata*. In the *Mahabharata* is given that lion, tiger, boar, buffalo, elephant, bear, and ape are the seven wild animals (*aranya*); and cow, goat, sheep, horse, mule and ass are seen domestic animals. Of the former group, boar, buffalo and elephant are reared. The kings themselves, the *Ksatriyas*, owned and reared the cattle and cattle-wealth was the mainstay of their house-hold finances. The outstanding examples are the emperor of *Kosala* (*Ramayana*) or of the prince of *Kasi* (*Jataka*). The kings maintained buffaloes, camels, asses, mules, swine and dogs for a variety of purpose (*Arthashastra*) besides horses, elephants, cows, sheep, and goats. In the *Dhumakari Jakti*, the high bred Brahmin is a goat keeper. The *sethis* or merchants mentioned in *Jataka* were also keeper of cattle. The art of weaving gradually developed and is considered as a further adaptation of basket making from bamboo, which was a natural resource of the forest. The fibre used was the wool of sheep, which was woven into carpets and fabrics for garments. The *Rigveda* mentions about the fine quality of wool of sheep and the domestication of the animal by the ‘*Gandhars*’ in the north-east of India.

The Vedic Aryans were primarily pastorals and grazed their cattle in the forests. The Kings were required to make ample provision for pastures by setting apart suitable land at the time of forming villages. The *Arthashastra* mentions about the breeding policy for animals. It has also defined the duties of graziers. The graziers were asked to attach bells to the necks of their cattle so as to scare away snakes and tigers. The sound of the bell helped the graziers in locating the whereabouts of the herd. Cow was the principal wealth and symbol of Aryans and most of the wars were fought for acquiring cows. The cows were milked three times a day and castration of bull was practiced. Zebu bull was the symbol of Gupta dynasty (240 B.C.). The coins during the Gupta period bore the image of ‘*Nandi bull*’, which is a humped Zebu. Improvement of Zebu cattle was the most important step taken by man in the development of agriculture. The preference of Zebu for dry land and its aversion for water indicate its origin in the dry mountainous environment. Similarly buffalo played an important role in the economy of ancient India. In the Mauryan age, the buffalo became a recognized dairy animal. The female buffalo gave plenty of milk and male was ideal for transport and for ploughing in the muddy rice-fields. One of the centres of domestication of buffalo in India was the Indus valley. In India, buffalo is valued on

account of its higher milk yield and higher fat content in milk, which is suitable for the preparation of Ghee (butter-oil). Ghee is one of the important components of diet and widely used in religious functions also. During the Mughal rule, large parts of the country were pastoral and rearing of sheep was a flourishing occupation of many people. Emperor Akbar (1555–1605) promoted the wool industry particularly related to the manufacture of ‘Shawls’ and carpets. Shawls made from ‘TUS’ were famous for lightness, warmth and softness.

D. Breeding of Cattle

In the Agnipurana we find the king enjoined to preserve the breed of cattle in the country. There were certain restrictions on castrating bulls. Emperor Asoka issued an order that a bull, a goat or a ram must not be castrated on the 8th, 10th, 15th and 13th day of each fortnight, neither on the *Punarvasu* day, on a festival day and in every fourth month of the year. A herd of 100 head of asses and mares shall contain five stallions, that of goats and sheep ten rams, and those of cows, buffaloes and camels shall contain four breeding males each.

E. Sacredness of Animals

The cow is the foremost of all quadrupeds as surely as the Brahmana is among the four castes. The deification of bull is considered as the animal of Siva. The Siva with his bull is represented in the coins of the Kusanas and Scytho-Sassanian kings and in a coin of Sasanka, king of Gauda. But it is for the first time and as late as in a coin of the Huna Mihiragula that a bull-emblem of Siva is seen with the legend. ‘Jayatu vrsah’ on the reverse. Touching a cow with feet is in (Ramayana and Mahabharata) is to be read with the crimes indicated for cruelty to cows. Cows have been mentioned as a symbolical representation of the Earth rays of sun or the Goddess of speech. In the *Matsya Purana*, the earth is represented as taking the form of a cow. At the root of the (cow’s) horn sits Brahma, in its middle sits *Kesava* (Lord Visnu) and at the end sits Siva—thus, the triad of gods resides there permanently. At the tip of the (cow’s) horn are all the holy places as well as personages and all the gods reside in her body. Thus cow is the very embodiment of all the gods. At the top of her forehead resides the goddess (Parvati), in her nostrils the god *Kartikeya*, and in her ears the two Naga (serpent) chief *Kambala* and *Asvatara*. In the eye of that divine *Surabhi* (cow) and the sun and the moon, in the teeth the eight *Vasus* and in her tongue sits the god *Varuna*. The Sarasvati resides in her lowing, Yama and Yaksa (Kubera) on her temples, the *risis* (sages) in her pores and the water of the Ganges in her urine. The Yamuna along with other goddesses resides in her dung. Twenty-eight crores of gods dwell in down.

F. Dairying in Ancient India

In the Indian mythology, the cow has been termed as the “mother” and the whole body of the cow has been described as the permanent abode of various Gods and Goddess. Cow is the mother of Rudras, daughter of Vasus, sister of Aditi’s sons, and is “Ambrosia” in the form of ghee. Lord Krishna used to call his cows by name (a method of identification of animals). In Garg Samhita (Golak Khand) three titles, which used to be conferred upon persons possessing cowherds namely, (i) Brakh Bhanu—the person who reared 10 lakh (one million) cows, (ii) Nand—the person who reared 9 lakh cows and (iii) Upnand—the person who reared 5 lakh cows.

Regarding the milk processing and its conversion into different products, sufficient evidence is available in the Mahabharata regarding items such as curd, butter and ghee, and these were prepared in every household. The traditional technology of milk heating (simmering), *i.e.*, slows heating for a longer time on the fire of dried cow dung cakes is prevalent even today. The Westerners could know the importance of heating milk much later and the process of pasteurization came into being only after

1862 A.D. During the rainy season, autumn, and the dewy season they should milk the cattle both the times (morning and evening); and during the winter, spring and summer, only once (*i.e.*, in the morning). He who milks the cattle a second time during these seasons shall be punished by having his thumb cut off. If he allows the milking-time to lapse, he shall forfeit his remuneration for that time. A 'drona' of a cow's milk will yield one 'prastha' of ghee; the same quantity of buffalo's milk will yield one-fifth more; and that goats and sheep will yield two-fifths more.

G. Rearing and Care of Cows (Brhat Parasara Samhita)

The householder should milk the cows in the morning as well as in the evening. They do not, as a rule, make increase in their yield of milk if the milking man is changed. The cow is the very congregation of all the gods, for in her head sits the god Brahma, on her shoulders Siva, on her back Vishnu, in her feet the Vedas and whatever other gods are left, they occupy every hair on her body. The Lord Hari (Vishnu) is pleased with devotional attentions paid to her. A cow should not be milked without her calf, nor when she is pregnant. One who milks her prior to ten days after her delivery, goes to hell.

H. Therapeutic Aspects in Dairy

Human milk has been considered as remedy for '7-fold doshas'. The milk of black complexioned women is considered for the treatment of eye diseases whereas the milk of fair complexioned women is used for the treatment of 3 doshas. The cow milk in general is strength giving. Milk of white cows cures "Vaata" (rheumatic and cardiac complaints) and the milk of black cows cure kafa (lung infections). The milk of black teats possess highest medicinal value which no other kind of milk approach. Like this, there are many mentions of medicinal value of cow milk in Rigveda and Atharvaveda.

In ancient medical treatise Charak Samhita, ten characteristic of cow milk, *i.e.*, tasty, cooling, soft, oily, thick, mild, viscous, bulky, and resistant to external effects and has pleasant flavour have been described. Not only this, the morning cow milk (pratardoha) midday cow milk (saganv) and evening cow milk (samandoha) possess different characteristics and properties. This type of analysis has been mentioned in an old treatise 'Bhava Prakash' as under: Before-noon milk is appetizing, digestive and improving semen quality, at-noon milk gives strength and destroys cough and liver ailments and increases hunger. In childhood it stimulates growth and in old age prevents wasting, and increasing sperms by daily consumption in night the milk cures many diseases. Hence, milk can be consumed at any time. In 'Susruta Samhita' the properties of cow milk and dahi (curd) have been described as flavored, tasty, digestive, strength giving, restorative, pure and pleasant, and anti-rheumatic. Given with equal proportion of honey, butter, peepal, dry ginger, black pepper, Vacha and rock salt (sendha namak) together and mixed them with same quantity of cow curd, removes the ill effects of snake poison. The malai (thin accumulate on milk surface after heating) of milk has been known to possess immense capability of completely eradicating of ailments associated with the imbalances of Vaata (rheumatic) and pitta (liver disorder) in addition to providing vigour and strength. Ancient literature states that there is a nerve in the spine of a cow termed as suryaketu which when exposed to sun synthesizes gold, imparting anti-poisonous properties to the milk. This is cow ghee is supreme in characteristics. It cures all the three doshas (imbalance of humours) and inactivates toxins and improves eyesight.

I. Animal Management

During post-Vedic era medicines occupied an honorable position and Samhitas by Charaka and Shusruta were followed from about 700 B.C. At that time there was development of materia medica. The only source of use of indigenous drugs in veterinary medicine is Agni Purana, which reveals the real picture

of practice of veterinary medicines during the Gupta dynasty (300-500 A.D.). The ancient system of Indian medicine is termed Ayurveda (Gavyayurveda for cattle, Hastyayurveda for elephants, and Ashvayurveda for equines). Shalihotra lectured on the subject of horse and its treatment, the "Ashvayurveda" or "Turangama shatra". Garuda Purana also describes the treatment of horses. King Nala had a surname 'Ashvavit', *i.e.*, versed in the science of horses. Nakula and Sahadeva, the twin sons of Madri, were taught by Drona the art of training, management and treatment of horses and cattle respectively. In the Mahabharata, Virata Parva, third PART, when the Pandavas entered into services of King Virata, Nakula declared himself well versed in the science of management and treatment of horses, and Sahadeva referred to his scientific knowledge about the cows. To Nakula is ascribed the work called Ashvachikitsa or "Treatment of diseases of the horse" which is still in existence. This book is also called "Shalihotra". In the Mahabharata, Virata Parva (PART III) Sahadeva, the fifth Pandava, has described himself as well versed in the science of management and treatment of cows. He also mentions that he knows such type of cows and bulls whose urine when smelled by a barren woman, the conception occurs (Mahabharata, Virat III.12). Perhaps the cow urine contains some type of hormone, which needs to be investigated. Nakula Samhita is considered the first treatise dealing with treatment of animals with herbal preparations and was compiled during the Mahabharata period. During the early medieval period drugs of vegetables and animals origin and minerals have been used for treatments. Jayadeva also wrote on the treatment of horses and he is quoted by Jayadatta. Shalihotra, father of veterinary science in India, flourished in Shalatur, a town near Kandhar or old Gandhara. According to an incomplete manuscript of Shalihotra (India Office Library, London), he is described as the father of Susruta. Hastyayurveda or Gahayurveda is also an important branch of veterinary medicine. The source of the science is Palakapya's Hastyayurveda which is now available (Published in Anandashran Sanskrit Series, Poona, 1894). Susruta Samhita. Thus it may be assumed that this work also belongs to 1000 B.C.

Kautilya, the prime minister of Chandragupta Maurya (325–260 B.C.) in his Artha-sastra refers to the duties of military surgeons to treat and protect the infantry horses and elephants from diseases, epidemics, and food problems. The camel and the dog are conspicuous in royal stables and kennels (the mention of dogs in royal house-hold is frequent in the Ramayana). The ducks are not seen in domestic animals. Cow, buffalo, goat and sheep were reared for dairy as well as for meat supply and skin. Swine and fowl were meant entirely for consumption. The ox alone drew the plough. The bull, mule, ass and camel were used for draught (on rare occasions also horse and elephant (Arthasastra). The dog assisted herdsmen to reconnoitre grazing forests (Arthasastra) or guarded royal apartments or served as hunting accomplices to the king or nomadic huntsmen (Dasabrahmana Jataka). The horse and elephant were employed according to their varied nature for draught riding and war. Animals used for draught purposes were generally castrated and sometimes their horns were cut off (Mahabharat). The beasts, wild and domestic yielded a large variety of animal produce *viz.*, skin, claw, horn, hoof, plume, tusk, wool, etc.

Every villager also used to keep a few animals for draught purposes or for doing or to meet the supply to his own household. The village maintained common on pay or on a share of produce, shepherds, who were entrusted with the work of taking the animals to the pasture ground in the morning and bring them back in the evening (*Anguttaranikaya; Rigveda*). The Arthasastra rule requires of Herdsmen is the knowledge to treat cow diseases and ford them safely. The Arthasastra wants the best herd to be entrusted for a fixed wage for otherwise they may be spoiled by over milking. Herds of the next grade are surrendered for a fixed amount of dairy produce, *viz.*, 8 varakas of ghee per year, which the owner will receive. Black, red or black and red bulls are, commended for yoking to the plough.

Therefore at the commencement of tilling the land one should take care to select bulls of this kind and smear the sides of the mouths with butter or ghee.

J. Animal Feed

The breeds were fed on barley and corn, and in the Agnipurana, a calf marvellously thriving on a food consisting of masa (*Phaseolus radiatus*), sesame, wheat, clarified butter, the cream of milk and salt. For bulls which are provided with nose strings and equal horses in speed and in carrying loads, half a *bhara* of meadow grass, twice the above quantity of ordinary grass, one *tula* (100 *palas*) of oil cakes, 10 *adhakas* of bran, 5 *palas* of salt, one kudumba of oil for rubbing over the nose, one *prastha* of drink, one *tula* of pulp of fruits, one *adhaka*, of curd, one *drona* of barley or cooked *masa*, one *drona* of milk or half an *adhaka* of *sura* (liquor), one *prastha* of oil or ghee (clarified butter), 10 *palas* of sugar, and one *pala* of the fruit of *sringavera* which may be substituted for milk. The same commodities less by one quarter each will form the diet for mules, cows and asses and twice the quality for buffaloes and camels. All cattle should be fed with fodder and water to their satisfaction. For draught oxen and cows yielding milk, the feed shall be provided in proportion to the duration of time the oxen are put to work and the quantity of milk, which the cows yield.

K. Protection of Cattle

Cattle must be protected from brutes and thieves. Instances of taking flesh except on ceremonial functions are available in ancient literature. Taking of animal food is strictly forbidden in ancient laws under the threat of expiable sin and eternal perdition unless taken in conformity with the law, *i.e.*, Vedic rites and sacrifices. Fines are enjoined for neglecting nasal perforation in proper time for stringing draught beasts to the yoke. Milking of cattle is allowed twice a day during the rains and the autumns, but in the dry winter and summer seasons only once on pain of the cowherd losing his thumb. Once in six months sheep and other animals shall be shorn of their wool. Stud bulls, bulls let out in the name of village deity (*gramadevavrshah*) and cows within ten days of calving are exempt from penalization for trespass. Ropes and whips only are to be used in case of stray cattle and any injury to them incurs the penalty for assault. Livestock is protected along with other properties of a householder by laws of torts. "For causing pain with sticks, etc., to minor quadrupeds, one or two *panas* shall be levied; and for causing bleeding to the same, the fine shall be doubled. In the case of large quadrupeds not only double the above fines, but also an adequate compensation shall be levied. A person who himself kills or steals the cattle or instigates another to do so, should be punished with death.

L. Indigenous Knowledge for Management of Livestock Diseases

In ancient India people had sufficient knowledge of the diseases of farm animals and the methods of curing them. Vishnudharmottara Mahapurana (500–700 A.D.) contains information on the medical practices of treating the diseased animals. Dipping the food of animals in its urine for the control of food and mouth disease. Dipping the tail in hot water or by applying powdered camphor for overcoming tail neurosis feeding ground neem leaves for internal parasites. Feeding sprouted whole wheat for 10–15 days continuously for anoestrus, etc.

1. **Mastitis** - Mastitis is caused by injury of the udder and by subsequent invasion by pathogens. The udder is inflamed and becomes hard. Sometimes a tumor is formed in the teats and during milking the animal feels severe pain and does not allow milking. For curing this disease the livestock owners follow mainly three practices. They either apply a mixture of ghee, sugar, and curd on the inflamed portion or sometimes milk froth around the teat. Both these practices according to scientists are effective as the ingredients used to act as soothing agents and soothe

- the hard teat with cracks. Another practice is to give hot bath to the affected animal. This helps in reducing inflammation, pain, and swelling, and also increases blood circulation.
2. **Foot-and-mouth disease** - Foot-and-mouth is an acute infectious disease caused by a virus and occurs in animals at any time round the year. The common symptoms of this disease are high fever, sluggishness, smacking of the lips, abrupt reduction of milk yield, and abortions. For treating this disease the livestock owners follow many practices. They wash the affected portion with fitkari (alum). Alum acts as an antiseptic; it checks secondary infection by inhibiting pathogens. It is an astringent and also helpful in coagulation of blood. Sometimes the foot of animal is dipped in its urine as the latter has germicidal property. Also, application of ground custard apple leaves or sprinkling camphor powder on affected area is practiced. Both act as a fly-repellent, and are anti-inflammatory and give soothing effect. Sometimes the livestock owners warm garlic pieces in hot mustard oil and after the oil cools, apply it on the affected area. Scientists opined that due to pungent smell it acts as a fly-repellent. It also acts as an antiseptic and disinfectant. Another practice is to wash the affected area with hot water, as it has cauterization property, which is helpful in checking bleeding.
 3. **Tail neurosis** - Tail neurosis is treated by dipping the tail of the animal in hot mustard oil or by applying powdered camphor on the affected area. Both these practices are scientifically correct as camphor acts as a fly-repellent whereas hot mustard oil is antiseptic, fly-repellent, irritant, and also helpful in fast healing.
 4. **Pneumonia** - The traditional treatment followed by villagers for curing pneumonia is to drench local liquor 3–4 times a day and apply mustard oil on the chest of the affected animal. The disease symptoms are shivering and rise in body temperature. Both these practices provide warmth to the body and are helpful in eliminating cold from the body. Also, the animal is made to inhale turpentine or eucalyptus oil. Inhalation of the oil is effective in easing respiration.
 5. **Anoestrus** - Anoestrus is a reproductive disorder where the animal does not have regular heat cycle, i.e., either it does not come in heat or remains continuously in heat thus prolonging calving interval. It may be due to hormonal imbalance or improper feeding or persistent corpus luteum or presence of cyst in ovary thus hindering proper ovulation and heat cycle. For curing this disease, livestock owners follow mainly two practices, which are scientifically correct, i.e., the animal is fed with a mixture of methi (*Trigonella foenum graecum*), gur (Gaggery), and bajra (Pearl millet). These substances act as stimulants and help in stimulating estrogen hormone. Also, sprouted whole wheat is fed for 10–15 days continuously. The sprouts are rich in vitamins and minerals and thus help in increasing fertility.
 6. **Retained placenta** - The indigenous practice followed by villagers is to drop the placenta by hand with the help of experienced people. According to scientists if the placenta does not fall within 48 hours it must be dropped by hand. Another practice is to feed the animal its own milk. Animal milk is rich in calcium, vitamins etc. It helps in maintaining uterine tone, which is helpful in retention of placenta. Some villagers use ten mango (*Mangifera indica*), leaves, two pieces each of jaiphal (*Myristica fragrans*) and kaiphal (*Myrica magi*). All these materials are ground and made into paste and then heated gently. The nearby area of vagina and thigh of the affected animal is then massaged with the warm paste. The placenta is expelled from the uterus within one hour of application. According to scientists, mango leaves have laxative and anti-hemorrhagic properties. Both the properties are essential for the removal of placenta. Kaiphal acts as antiseptic and farmers use it for the removal of placenta where presence of infective organisms is always expected. Jaiphal works as febrifuge and narcotic.

7. **Diarrhea** - Frequent expulsion of profuse loose watery bowel content is termed as diarrhea. This condition always involves abnormality in stomach and intestine. Farmers reported that they feed the mixture of mustard oil, water, and edible soda. Scientists considered the practice correct as sodium bicarbonate balances pH of the body and water helps to check the fluid loss.
8. **Indigestion** - The traditional treatment followed by villagers for curing this disease is to feed the mixture of dhania (*Coriandrum sativum*) and jeera (*Cuminum cyminum*). These are carminatives and help in easy digestion of food. Also, the animal is fed with overnight soaked mixture of yellow mustard oil cake, jaggary, and salt after thorough cooking. Scientists reported that yellow mustard oil cake is rich in calcium and phosphorus, which helps in secreting digestive juices and increasing enzymatic activity. Salt improves the secretion of digestive juices and jaggary provides energy. Black salt, jeera, adrak (ginger; *Zingiber officinale*) and garlic paste is given to the animal. These substances increase the appetite by increasing motility of intestine and help in rapid digestion. Black salt is a mild laxative.
9. **Tympany** - The traditional practice followed by farmers for treating tympany is to feed turmeric powder in curd; ajwain (*Trachyspermum ammi*), and salt in water; mixture of ajwain, heeng (*asafoetida*), garlic salt, methi, and turmeric; and garlic and ginger paste with common salt and mustard oil. Scientists opined that all these substances are carminative and antifatulent, help in improving appetite, and do not cause constipation. Another practice followed is to make the animal to run fast as it helps in expulsion of gases.
10. **Hemorrhagic septicemia** - Hemorrhagic septicemia is an infectious disease, usually acute in nature caused by bacteria (*Pasteurella multocaeda*) and affects mostly cattle and buffaloes. The informants mentioned that they give hot ash massage to the affected animal. The scientists reported that this practice is helpful in reducing inflammation and swelling. Sometimes a sharp cut on a swollen portion is also given, which decreases blood supply, reduces swelling, and facilitates respiration.

The livestock owners practice different techniques, which have been inherited over generations, and developed by indigenous trial and error methods. Most of the livestock owners in rural areas had a tendency to treat their livestock through traditional knowledge of medicinal properties of herbal products available locally (Table 2.16).

Table 2.15. Indigenous Animals Management practices (pregnancy and delivery) followed in parts of Rajasthan and their Scientific Validity

<i>Area/Sub area</i>	<i>Indigenous practice</i>
Heat identification in animals	Through mucous discharge from vagina from bellowing, eating less food, frequent urination, mounting on another cow, raising its tail, swelling inlets etc.
Breeding	Prefer first or second day of heat for getting animal crossed. Get the animals crossed with available (desi) bull of the village.
Way of recognizing that animals has conceived	By observing sings of animals <i>i.e.</i> , does not come in next heat, dull temperature stops jumping, kicks by legs, milk production decreases etc.
Care of pregnant animals	Allow pregnant animals to go out for grazing. Dry the animals 2-3 months before parturition.
Feeding during pregnancy	Concentrate is fed to pregnant animals, which includes several grasses, barley water, moong and moth, chui guar, churi wheat and methi dalia.

(Contd.)

<i>Area/Sub area</i>	<i>Indigenous practice</i>
Area/Sup Area	Indigenous practice.
Symptoms before actual parturition	Pelvic hip bones look depressed skin near the tail regions looks relaxed enlarged teats full with milk uneasiness and frequent sitting and standing.
Facilitating delivery	Give mixture of jaggary ajwain methi dried and crushed ginger and waste of oilseeds.
Care during parturition	Clean the place of calving. Give comfort to pregnant animals by spreading something underneath <i>i.e.</i> , dry grasses, jute bags etc. House pregnant animals in separate place or room.
Expulsion of placenta	Give “hot” food as jaggary sugarcane leaves/bamboo leaves/rice bran, animal’s own milk etc.
Postnatal care	Mixture of dried and crushed ginger ajwain, cumin seeds, jaggary and oil is prepared and given up to 15 days. Mixture of green gram dhal and turmeric in water is given.

M. Use of Animals Flesh as Human Food

The usefulness of cattle in India for power, food and manure was fully realized with the development of agriculture. The earlier practice of animal sacrifice was given up under the influence of Buddhism and bullocks became the companion of man in the conquest of virgin lands. Indian farmers regard cattle as members of their own social group and treat them with reverence on different occasions during the year. The virtues of ahimsa and abstention from meat-diet are followed by exceptions made in favour of sacrifice and hunting for the royal race in the Mahabharata. Buddha himself allows fish and flesh to his disciples. Strabo’s remark on Megasthenes authority that the Brahmanas “eat flesh but not that of animals employed in labour”, whatever truth it may contain, reflects at any rate a sound economic sense which in some quarters regulated animal diet. Animals are to be slaughtered for flesh only in the abattoir (parisunam) on pain of fine. The varieties of animal flesh were also disposed of from separate stalls in the market place and different sets of stockists and butchers thrived on them; *e.g.*, the cattle-butcher, sheep-butcher, pig-sticker, fowler, deer-stalker, etc. In its rules on cow slaughter, the Arthashastra wants the immunity of only calves, milch cows and stud bulls. In the Satapatha Brahmana, Yajnavalkya is fond of tender beef. According to Panini ‘goghna’ means a ‘guest’ because a cow is killed for him. Apastamba permits the slaughter of a cow at the reception of a guest, at the worship of the *manes* and at nuptial celebrations (Grhyasutra; Manu). In Bhavabhuti’s Uttararamacarita a heifer is stated to be slain by Valmiki in honour of Vasistha’s visit to his *asrama*. According to the Dasabrahmana Jataka, Slaughter of ox for flesh was very common and there were special slaughter-houses for beef. Even cows did not necessarily find exemption. In a Vinaya list of unpalatable and inedible food to which the people fell only in famine, occur, elephant, horse, dog and snake. Fowl, swine and cow never come in the list of animals and birds forbidden even for the Brahmana’s table. Beef and ham are classed among non-edibles. High-crested cocks born of Vrtra’s blood (sikhandah) occur as non-eatable to the twice-born and the initiated in the Mahabharata. Cocks and pigs occur in an exhaustive list of animals prohibited for the Snataka Brahmana in Gaut. XXIII. 5 and Manu. In the Ramayana cow-killing and milking a cow just delivered are sins.

N. Use of Cow Dung as Plant Food

If one wishes the prosperity of his cattle, one should not even by mistake allow the cow dung to be removed on Sundays, Tuesdays and Saturdays. Barring the above three days one may give away the

cow-dung to anybody. The removal of cow dung on Tuesdays and Saturdays is detrimental to cattle. A successful cultivator should worship the heap of cow dung in the month of *Magha*, 'and on an auspicious day he should turn up the manure with spades. Reducing the manure, which is drying in the heat of the sun, into the powder, should deposit it in pits, in each field in the month of *Phalguna*. Then at the time of sowing, he should dress the field with manure or without manuring the crop neither thrives nor yields fruit.

2.44 DESCRIPTION OF INDIAN CIVILIZATION AND AGRICULTURE

2.44.1 Indus Valley Civilization

Allchins, relying on Lambrick, who, according to them, had personal knowledge of Sind, describe as follows how crops were grown in the riverain tract of the Indus. "The principal food grains, that is wheat and barley, would have been grown as spring (*rabi*) crops: that is to say, sown at the end of the inundation upon land which had been submerged by spill from the river or one of its natural flood channels, and reaped in March or April. In modern practice such land is neither ploughed nor manured, nor does it require additional water. Lambrick remarks that 'the whole operation involves an absolute minimum of skill, labour and aid of implements. Other crops, including cotton and sesamum, would be sown as autumnal (*kharif*) that means they would be sown at the beginning of the inundation and harvested' at its close, in autumn. For this fields surrounded by earth embankments would be required, most probably along the banks of natural flood channels. Although this method is more precarious than the former, both exploit the natural fertility of the alluvium, and the annual inundation. Both systems are still in use. According to my experience of cultivation in the riverain areas of the Punjab, when the land has appropriate moisture, land is ploughed, seed is sown and the soil is smoothed with a plank. The practice followed by the Harappans could not have been different. For the proper sowing of crops, soil has to be stirred and seed has to be covered.

Alexander and his successors and Megasthenes set the stage in the history of Greek presence in India and the 'Indica of Megasthenes' analyzes the Greek account of India. Seleucus was the ambassador to Chandragupta Maurya. The book covers the history of the Greek kingdoms and northern India and the development of the Indian Ocean trade. Sandwiched between these two historical sections lies the core of the book: two massively detailed PARTs surveying Greek knowledge of India. The first deals with the physical geography of India, its hydrology and meteorology, and the second with the natural history of the subcontinent including its biology and geology and their military, commercial, and even medical implications. Megasthenes states that Maurya officers were concerned with the measurement and supervision of alluvial deposit for revenue purpose.

The Greek writers highly praised the fertility of Indian soil and favourable climate condition and inner-system while describing the principal agricultural products of the land. Since there is double rainfall in the course of each year, one in the winter season, when the sowing of wheat takes place as in other countries, and the second at the time of the summer solstice which is the proper season for sowing rice and 'bosporum', as well as sesamum and millets-the inhabitants of India almost always gather in two harvests annually (Diodorus, II. 36). The Greek writers also affirm that India has a double rainfall and the Indians generally gather two harvests-Megasthenes witnesses-the sowing of wheat in early, winter rains and of rice, 'bosporum', sesamum and millets in the summer solstice (Diodorus, II, 36). **Megasthenes** adds further to the winter crops, *viz.*, "wheat, barley, pulse and other esculent fruits unknown to us".

1. The Chinese pilgrim **Hsieun Tsang** who arrived at the monastic University of Nalanda in

630 A.D. mentioned the gardening as: "The temple arose into the mists and the shrine halls stood high above the clouds . . . streams of blue water wound through the parks; green lotus flowers sparkled among the blossoms of sandal trees and a mango grove spread outside the enclosure." What the Arab gardeners regarded as correct rules for planting, and some of the garden plants which they favored, says Hyams, can be gathered from an authoritative twelfth-century work on agriculture and horticulture written by Yahya bin Muhammad (Abu Zakariya). Abu Zakariya says that all garden doorways should be farmed by clipped evergreens, that cypresses should be used to line paths and grouped to mark the junctions of paths. He observed an object to the mixing of evergreen with deciduous trees. He observed loss of water through evaporation. Plants named in his text include lemon and orange trees, pines and most of our common deciduous trees, cypresses, oleander, myrtle and rose as the only flowering shrubs, violets, lavender, balm, mint, thyme, marjoram, iris, mallow, box and bay laurel. He lays much stress on aromatics, as, indeed, did all the Islamic gardeners. His climbing plants are vines, jasmines and ivy.

2. **Babur-NAMA** - An Autobiography and a Book on Natural History: Babur-nama reflects the character and interests of the author, Zehir-ud-din Muhammad Babur. Babur, the founder of the Mughal dynasty in India, is regarded as one of the most romantic and interesting personalities of Asian history.
3. **Alberuni** (Abu Raihan Muhammed bin Ahmed), a Central Asian scholar, with keen perception, came to northern India early in the eleventh century, and made a remarkable observation on the structure and formation of the Indo-Gangetic alluvium. "If you have seen the soil of India with your own eyes and meditate on its nature," wrote Alberuni, 'if you consider the rounded stones found in the earth, however deeply you dig, stones that are of smaller size at greater distance from the mountains, and where the streams flow more slowly, stones that appear pulverized in the shape of sand where the streams begin to stagnate near their mouths and near the sea, if you consider all this, you could scarcely help thinking that India has once been a sea which by degrees has been filled up by the alluvium of the streams.'

Protection of cultivators - Sher Shah had genuine concern for the peasantry and safety of their crops. Abbas Khan states, One of the regulations Sher Shah made, was this: That his victorious standards should cause no injury to the cultivations of the people; and when he marched he personally examined into the state of the cultivation, and stationed horsemen round it to prevent people from trespassing on anyone's field. I have heard from Khan-i-Azam Muzaffar Khan, who said he often accompanied Sher Shah, that he used to look out right and left, and (which God forbid) if he saw any man injuring a field, he would cut his ears with his neck, would have him to be paraded through the camp. And if farm the narrowness of the road any cultivations was unavoidably destroyed and give compensation in money to the cultivations. If he enters an enemy's country, he did not enslave or plunder the peasantry of that country nor destroy their cultivation. 'For, said he, the cultivators are blameless, they submit to those in power; and if I oppress them they will abandon their villages, and the country will be ruined and deserted, and it will be a long time before it again becomes prosperous.

As regards the peasantry and their condition, there is reliable evidence in the observations of the European travellers who travelled in India in the seventeenth century. **Peter Mundy** tells us that the peasants near Agra were treated 'as Turks treat Christians', 'taking from them all they can get by their labour, leaving them nothing but their bad, mud-walled, ill-thatched houses and a few cattle to till the ground, besides other miseries.'

Pelsaert, who was in Agra during the rule of Jahangir, observed: 'The land would give a

plentiful, or even an extraordinary, yield if the peasants were not so cruelly and pitilessly oppressed; for villages which, owing to some small shortage of produce, are unable to pay the full amount of the revenue-farm, are made prize, so to speak, by their masters or governors, and wives and children sold on the pretext of a charge of rebellion. Some peasants abscond to escape their tyranny, and take refuge with rajas who are in rebellion, and consequently the fields lie empty and unsown, and grow into wildernesses. Such oppression is exceedingly prevalent in this country.' Bernier, commenting on the state of the northern part of the country, its agriculture and peasantry, states: 'Of the vast tracts of country constituting the empire of Hindustan, many are little more than sand, or barren mountains, badly cultivated, and thinly peopled; and even a considerable portion of the good land remains untilled from want of labourers, many of whom perish in consequence of the bad treatment they experience from the Governors. These poor people, when incapable of discharging the demands of their rapacious lords, are not only often deprived of the means of subsistence, but are benefit of their children, who are carried away as slaves. Thus it happens that many of the peasantry, driven to despair by so execrable a tyranny, abandon the country and seek a more tolerable mode of existence, either in the towns or camps, as bearers of burdens, carriers of water, or servants to horsemen. Sometimes, they fly to the territories of a Raja, because there they find less oppression, and are allowed a greater degree of comfort.

4. In Vijayanagar, **Abdul Razzak** (A.D. 1336–1646) saw that palm leaves were used for writing and paper was not known. He observes, 'the inhabitants of cambay alone use paper. All other Indians write on the leaves of trees. Abdul Razzak observed that chewing of pan (betel leaf) was a common practice at Vijiyanagar, and he attributes virility of the king to its stimulating properties.
5. **Quest for Spices** (1498–1580 A.D.): The Europeans had to pay extortionate prices for spices, particularly pepper, which not only made their food tasty, but was also used as a preservative for meat. Pepper was also used in wine and pastry.
6. **Domingo Paes**, a Portuguese merchant, who visited Vijiyanagar in A.D. 1520. Domingo Paes presented a pair of spectacles to Vyasraya, guru of Krishnadevaraya. Krishna Deva of Vijayanagar constructs the great dam and channel at Korragal, also the Basavanna channel.
7. Garcia da Orta's *Coloquios dos simples e Drogas e cousas medicineis da India* (A.D 1563) includes description of many Indian medicinal plants. Christophoras Acosta's *Aromaticum et medicamentorum in Orientali India nascentium liber* and *Historia Natural R moral de las Indias scuilla* (Barcelona, A.D. 1591) are important works on medicinal plants of India.
8. **Stevens** is famous as the first Englishman known to have set foot on Indian soil. Born in Wiltshire and educated in Winchester, he made his way to Rome and there entered the Jesuit order. Being desirous of serving in India, he obtained a passage at Lisbon in the spring of 1579 and reached Goa in October of that year. He was the first European to make a scientific study of Konkani, and he wrote two religious works, one of which was a long epic in Marathi. Describing a visit to Malabar he mentions a number of crops including pepper and coconut. "Here grows the pepper; and it springs up by a tree or a pole, and is like our ivy berry, but something longer, and at the first the bunches are green, and as they wax ripe they Cut them off and dry them. The leaf is much lesser than the ivy leaf and thin to zero. All the inhabitants here have very little houses covered with the leaves of the coco-trees. All the pepper of Calicut and coarse cinnamon grows here in this country. The best cinnamon comes from Ceylon, and is pilled from the young trees. Here are very many palm or coco-trees, which is their chief food; for it is their meat and drink, and yields many other necessary things.

9. **Jeane-Baptiste Tavernier**, a French jeweller and merchant, visited India six times, between the years 1638 and 1688. He corroborates the account given by Bernier. He states: 'The peasants have for their sole garment a scrap of cloth to cover those parts which natural modesty requires should be concealed; and that they are reduced to great poverty, because if the Governors become aware that they possess any property they seize it straightaway by right or by force. You may see in India whole provinces like deserts from whence the peasants have fled on account of the oppression of the Governors.' The flight of peasants from the land intensified during the reign of Aurangzeb. With the decrease in the number of peasants, the income of the assignees, the *jagirdars*, was reduced. The *jagirdars*, to make good their loss, put increased pressure on the working peasants. Moreover, the practice developed of selling governments of provinces for immense sums in hard cash. Hence, it naturally became the principal object of the individual thus appointed Governor, to obtain repayment of the purchase-money, which he had borrowed at a ruinous rate of interest. This in turn resulted in more repression on the cultivators.
10. **Betel vines:** Ibn Battuta also saw betel vines in Kerala. He states, Betel-trees are grown like vines on cane trellises or else trained up coco-palms. They have no fruit and are grown only for their leaves. The Indians have a high opinion of betel, and if a man visits a friend and the latter gives him five leaves of it, you would think he had given him the world, especially if he is a prince or notable. A gift of betel is a far greater honour than a gift of gold and silver. Evidence of the structure of the Mughal gardens and plants grown in them is in the Persian classics illustrated during the reign of Akbar. Among them is *Diwan-i-Anwari*, a collection of poems by the Persian poet Anwari, who flourished in the latter part of twelfth century. It contains some excellent paintings on gardens and gardening. **Abu-l-Fazl** mentions three kinds of sugarcane, viz., *paunda*, black and ordinary. **Abu-l-Fazl** provides a list of twenty-one fragrant flowering plants along with the colour of their flowers and the season of flowering in the **Ain-i-Akbari**. After describing the indigenous flowering trees and shrubs, Abu-l-Fazl mentions the names of those introduced from foreign countries. Abu-l-Fazl mentions that Akbar imported gardeners' from Iran and Turan. Abu-l-Fazl provides a detailed account of fruits grown in India during the reign of Akbar in the *Ain-i-Akbari*. 'His Majesty looks upon fruits as one of the greatest gifts of the Creator, and pays much attention to them,' states Abu-l-Fazl. 'The horticulturists of Iran and Turan have, therefore, settled here, and the cultivation of trees is in a flourishing state.' 'Melons and grapes have become very plentiful and excellent; and water melons, peaches, almonds, pistachios, pomegranates, etc., are everywhere to be found. Abu-l-Fazl mentions the names of eighteen vegetables and the seasons in which they were grown. Food and fodder for royal horses was standardized. Abu-l-Fazl states, 'In winter, they give boiled peas or vetch; in summer, grain. 'The betel leaf is, properly speaking, a vegetable, but connoisseurs call it an excellent fruit,' states **Abu-l-Fazl**. 'The eating of the leaf renders the breath agreeable, and repasts odorous. It strengthens the gums, and makes the hungry satisfied, and - the satisfied hungry. I shall describe some of the various kinds. 1. The leaf called *Bilahri* is white and shining, and does not make the tongue harsh and hard. It tastes best of all kinds. After it has been taken away from the creeper it turns white, with some care, after a month, or even after twenty days when greater efforts are made. 2. The *Kaker* leaf is white with spots, and full, and has hard veins. When much of it is eaten, the tongue gets hard. 3. The *Jaiswar* leaf does not get white, and is profitably sold mixed with other kinds. 4. The *Kapuri* leaf is yellowish, hard, and full of veins, but has a good taste and smell. 5. The *Kapurkant* leaf is yellowish-green, and pungent like pepper; it smells like camphor. You could not eat more than ten leaves. It is to be had at Banaras; but even there it does

not thrive in every soil. 6. The *Bangla* leaf is broad, full, hard, plushy, hot, and pungent. There are several kinds of leaves known under different names: 1. The *Karhan* leaf, which they separate for seedlings and call *Peri*. The new leaf is called *Gadauta*. 2. The *Nauti* leaf. 3. The *Bahuti* leaf. 4. The *Chhiw* leaf. 5. The *Adhinida* leaf. 6. The *Agahniya* or *Lewar* leaf. With the exception of the *Gadauta* (i.e., new leaf), the leaves are taken away from the creeper when a month old. The last kind of leaf is eaten by some others keep it for seeding: they consider it very excellent, but connoisseurs prefer the *Peri*. 'A bundle of 11,000 leaves was formerly called *Lahasa*, which name is now given to a bundle of 14,000. Bundles of 200 are called *Dholi*; a *Lahasa* is made up of *Dholis*. In winter they turn and arrange the leaves after four or five days; in summer every day. People also put some betel nut and *kath* on one leaf, and some lime paste on another, and roll them up; this is called a *hira*. Some put camphor and musk into it, and tie both leaves with a silk thread. Others put single leaves on plates, and use them thus. They are also prepared as a dish.

The *Ain-i-Akbari* tells us that fish formed an important part of the people's food in Bengal and Orissa, and also in Sind. Travellers record that its use was common in the south of India, and that it was sometimes dried and salted for provisioning ships. Fish-oil was prepared in Sind, the use of fish manure was established in Gujarat when Thevenot visited Surat in 1666, and, speaking generally, it may be reasonably assumed that the fisheries were conducted very much on the familiar lines.

11. **Terry**, an English traveler, writes, 'The country was abounding with muskmelons. One could also find watermelons, pomegranates, lemons, oranges, dates, figs, grapes, coconut, plantains, mangoes, pineapples, pears, apples, etc.' Terry also mentions the use of coffee by some people. He writes, 'Many religious people drank a "wholesome liquor" which they called coffee. Black seeds were boiled in water, which also become black. It altered the taste of water very little. It quickened the spirit and cleansed the blood.'
12. **Francois Bernier**: Of the European travelers who come to India during the Mughal rule, the most intelligent and learned was Francois Bernier a Frenchman. Bernier gives a vivid description of Bengal its landscape people and its plant and animals products. With extensive fields of rice, sugar, corn, three or four sorts of vegetables, mustard, for oils and small mulberry trees two or three feet (61 to 91 cm) in height, for the food of silk worms. Goose and ducks are cheap. There are also goats and sheep in abundance and pigs are obtained at so low a price that the Portuguese settled in the country live almost entirely upon pork.
13. **Meadows Taylor** states "The Bahmanis constructed irrigation works in the eastern provinces, which incidentally did good to the peasantry while primarily securing the crown revenue. **Vincent Smith** points out that those items to their credit weigh lightly against the wholesale devastation wrought by their wars, massacres, and burnings. Their rule was harsh and showed little regard for the welfare of Hindu peasants, who were seldom allowed to retain the fruits of their labour much more than would suffice to keep body and soul together.
14. **Herodotus** (484-425 B.C.) the father of history reported in his writings that the wild Indian (cotton) trees possessed in their fruits fleeces, superseding those of sheep in beauty and excellence from which the natives used to weave cloth. Herodotus further wrote that "trees which grow wild in India and the fruit of which bear wool exceeding in beauty and fineness that of sheep wool Indians make their clothes with this tree wool". Some traveller writers fabricated stories of a lamb sitting inside the fruit. **Marco Pola**, a Venetian, who traveled widely throughout

the Asia in A.D. 1290 said that the coast of Coromandel (Madras, India) produced the finest and most beautiful cotton in the world. Indian cloth, particularly the Dacca muslin was renowned all over the world and has been described as 'webs of woven wind' by oriental poets. It was so fine that it could hardly be felt in the hands. It is said that when such muslins were laid on the grass to bleach and the dew had fallen, it was no longer visible. A whole garment made from it could be drawn through a wedding ring of medium size. There is also the often repeated tale of Moghul princes who put on seven layers of muslin and still the contours of her body were so visible that she had to be admonished by her father, Muhamed Bin Thughlak.

2.45 OUR JOURNEY IN AGRICULTURE

Indian history can be broadly divided into five phases based on archeological findings:

- Period of Saraswati (Harappan) civilization - 6500 B.C – 1000 B.C or also called 'Vedic period'
- Golden period of Indian History - 500 B.C – 800 A.D
- Muslim influence in India - 1000 A.D – 1700 A.D
- British period in India - 1700 A.D – 1947 A.D
- Modern India - 1947 – till date

The famine from 1876–78 led to institution of Famine Commission of 1880. George Nathaniel Curzon succeeded Lord Mayo as Viceroy of India. The horrors of Famine (1889–90) convinced Lord Curzon that urgent attention must be paid to agriculture. Lord Curzon passed the Land Alienation Act (1900) and Cooperative Societies Act (1904). Lord Curzon, the Viceroy of India with the generous donations from Henry Phipps of the USA had founded the Imperial Agriculture Research Institute in 1905 at Pusa, a village in the Darabhanga district of Bihar. The main building at Pusa was named after its donor as the Phipps Laboratory. [PUSA stands for the donor of the Institute, Phipps of the USA]. There was a disastrous earthquake in 1936 and Pusa suffered heavily. After careful consideration the Government of India rebuilt the institute at New Delhi. The transfer to New Delhi was completed by October 1936. The Marquess of Linlithgo, the then Viceroy of India, opened this Institutes in November 1936. This Institute (IARI) in Delhi is popularly known as the Pusa Institute. Under the University Grants Commission Act 1956, the Institute (at New Delhi) got the status of the Deemed University and Teaching and Research activities were intensified from 1958. In 1947, India had about 27 Agricultural and Veterinary Colleges including the Indian Agricultural Research Institutes, Indian Veterinary Research Institute and five other Agricultural Colleges established during the first decade of the century. These Colleges were purely teaching institutions affiliated to traditional universities and contributed little to research. Agriculture Colleges were started at Poona (Pune) and Kanpur. Teaching was the main mandate. The Civil Veterinary Department was established in 1889, the main attention was on horse and male breeding. Systematic investigation on animal breeding began in 1890 with the Imperial Bacteriologist at the College of Science, Poona. Which was shifted to Mukteswar where the Imperial Bacteriologist Laboratory was established in 1895. This institution has been pioneer in the field of Veterinary research in the Country. Veterinary Colleges were started at Bombay, Lahore (now in Pakistan), Calcutta and Madras. The Indian Central Cotton Committee (ICCC) (1921) was formed as per recommendation of the Indian Central Cotton Commission (1917–18).

The Government of India appointed a Royal Commission in 1926 to examine the condition of agricultural and rural economy in India. The Imperial Council of Agricultural Research (ICAR) was established in 1929 as a Society under the Societies Registration Act, 1860. The Society was registered

on July 16, 1929. [After Independence, the name of the society was changed to Indian Council of Agricultural Research (ICAR)]. The food crisis created by the Second World War and the Bengal famine in 1943 deepened and become the matters of great concern to Government of India. To meet the food shortage the Grow More Food campaign was started in 1943. On the recommendation of the Royal Commission on Agriculture in India (1927-1928), the Indian Lac Cess committee, though it had its origin in Lindsay-Harlow Committee (1921) got its statutory enactment in 1931 and the Indian Central Jute Committee (ICJC) on the line of cotton committee was set up in 1936. To undertake improvement and development of sugarcane, Jaggery (gur), Sugar and other by-products the Indian Central Sugarcane Committee (ICSC) was constituted in 1944. The Development Council for sugar industries was formed in 1951. The ICSC was entrusted with responsibility of Research on Sugarcane. The development of Gur was entrusted to the All India Village Industries and Khadi Commission. The Indian Central Coconut Committee and the Indian Central Tobacco Committee were formed in 1945. The Indian Central Arecanut Committee was formed in 1949 and the Indian Central Spices and Cashew nut Committee were formed in 1958. Regional stations\sub-station on cotton, Jowar, Finger millet, setaria, castor, groundnut, linseed, bajra were established and the PIRRCOM (Project for Identification of Regional Research on Cotton, Oilseeds and Millets) were started.

Agricultural development has to be guided not only by compulsion of improving food and nutritional security but also by the concern for environmental protection, sustainability, profitability and even export. Crop productivity has to be improved in comparison with other countries. Further following the WTO agreement and liberalization process, the consequent liberalization process, the consequent globalization of markets would call for competitiveness and efficacy of agricultural production. The process of agricultural development could be accelerated and sustained only through investments on research and education.

A. All India Coordinated Research Projects (AICRP)

The AICRPs were born from the coordinated project on maize developed with the Rockefeller Foundation's assistance in 1957, ICAR has now about 70 All India Coordinated Research projects covering various disciplines and commodity crops, livestock, fisheries, home science, and agricultural engineering. An AICRP enables effective utilization of the resources in man and material anywhere in the country to tackle some of the important national problems. The Indian Council of Agricultural Research is an autonomous apex body responsible for the: organization and management of research and education in all disciplines of agricultural sciences. It has been reorganized twice. In 1963 an expert committee (M.W. Parker Committee), was appointed by the Government of India to inquire into the present set up and to suggest suitable changes in the ICAR. The Committee submitted its report in 1964. As per recommendations of the committee the ICAR become an autonomous body; its rules and by-laws were revised. A scientist heads as Director General (DG). To assist the DG, four posts of Deputy Director General (DDG)-Crop Science, Soils, Agronomy, Irrigation and Agricultural Engineering, Animal Sciences and Agricultural Education were created. The Institute of Horticultural Research (Hassarghata), and Central Soil Salinity Research Institute (Karnal) were started. By this time there were 33 Research Institutes (25 in agriculture, 7 in Veterinary and animal husbandry and fishers and one in statistics) under the ICAR. In 1965, the ICAR became the nodal agency for coordinating agricultural research in the country. It gained administrative control over the various institutes and commodity research institutes. Late Dr. B.P. Pal took over as the first scientist as Vice President of ICAR. Dr. Pal instituted the All-India Coordinated Research Projects on various crops to integrate different disciplines and different institutions and universities for an effective national grid of coordinated experiments. He has been

internationally acclaimed for this contribution. In 1973, the Agricultural Research Service (ARS) was started by Dr M.S. Swaminathan, the first Director-General and Secretary of the Government of India and Dr Pal's, successor; to enable scientist's to move to other institutes within the system or sister organizations *viz.*, the CSIR, BARC, etc., ICAR started the National Agricultural Research Project (Phase I) in 1983-94. NARP Phase II was wound up in 1992. Intensive Agricultural Area Programme (IAAP) was initiated in 1964. From 1966-67, High Yielding Variety Programme (HYVP) in crops like rice, wheat, maize, jowar, bajra, was started. The Krishi Vigyan Kendras (KVKs) and Trainers 'Training Centres (TTCs) were established on the recommendations of the Education Commission (1964-66). The Lab to Land Programme was launched by the ICAR in 1979 to extend and promote adoption of new technology among the small and marginal farmers and agricultural laborers to test the relevance of Technology under their socio-economic conditions.

B. ICAR Institutes

The ICAR is directly responsible for administering 32 research institutes in the fields of agriculture, animal sciences and fisheries. Some of these are single commodity-oriented crop institutions while a few of them undertake work on a number of crops. The Indian Agricultural Research Institute (IARI), New Delhi, the Indian Veterinary Research Institute (IVRI), Izatnagar, and the National Dairy Research Institute (NDRI), Karnal are the three national institutions which have responsibilities both for research and post-graduate education. However, only the IARI has been given the status of a deemed university by virtue of which it awards its own post-graduate degrees in the field of agriculture. NDRI and IVRI are performing this function through affiliation with other universities. The recent establishment of the National Academy of Agricultural Management at Hyderabad as a constituent unit of the Council is an important landmark in institution building. This Academy would be responsible for providing quality training to various categories of personnel involved in agricultural research all over the country. Establishment of an Agricultural Research Service (ARS) started on October 1st, 1975 marks yet another landmark in the history of research management of ICAR.

C. Agricultural Universities

The responsibility for research in most of the States is now with the 21 agricultural universities, which perform in an integrated way the functions of teaching, research and extension education. The ICAR has recently taken major steps to further strengthen the agricultural research capabilities of the agricultural universities through the National Agricultural Research Project (NARP), which is being implemented through the assistance of IBRD.

D. Krishi Vigyan Kendras (KVKs)

The ICAR has sponsored a programme known as the Krishi Vigyan Kendras, designed to provide skill oriented vocational training to practicing farmers, in-service field level extension. Workers or those who intend to go in for self-employment.

E. Other ICAR Schemes

- National demonstrations and Operational Research Projects in 1964-65
- Scheme of Professors of Eminence/National Fellows
- National Research Centres
- Advanced Centres of post-Graduate Education and Research

F. Timeline of Agricultural Activities in India Since Independence

<i>Year</i>	<i>Events</i>
1947	Central Tobacco Research Institute established at Rajmundry, (Andhra Pradesh). Central Marine Fishers Research Institute established at Cochin (Shifted to Mandapam in 1949). Central Island Fisheries Station (now an Institute) established at Barrackpore (West Bengal).
1949	Turlock Singh invents the concept of standard acre. Central Potato Research Institute established at Patina (It was transferred to Simla in 1956). The University Education Commission under the Chairmanship of Dr. S. Radhakrishnan, recommends the creation of rural universities.
1950	Indian Agricultural Research Institute started in Delhi. Intensive Cultivation Scheme in 19 Villages at the initiative of K.M. Munshi. Garden Colony Scheme Launched in Punjab.
1951	Fertilizer factory set up at Sindri (Bihar). The Japanese mint, source of menthol, introduced into India by Sir R.N. Chopra. A factory established at Calcutta to manufacture BHC. Indian Institute of Sugarcane Research started at Lucknow.
1953	Jute Agriculture Research Institute started at Barrackpur, West Bengal.
1955	National Dairy Research Institute started at Karnal. Fertilizer Association of India organized. Lower Bhavani Project completed in Madras (Tamil Nadu).
1956	All-India Soil Survey Scheme started in the IARI. Central Potato Research Institute started at Simla.
1957	Central Institute of Fisheries Technology started at Cochin.
1958	All-India Soil and land Use Survey Organization started.
1959	Institute of Agriculture Research Statistics, which made a modes beginning in 1933 as a Statistics, Wing of the ICAR, comes into being. (It was strengthened and renamed Indian Agricultural Statistics Research Institute in 1978). Central arid zone research institute established at Jodhpur (Rajasthan).
1960	International Rice Research Institute established at Los Banos, Philippines. Over the years, this institute actively collaborated with rice research in India. Govind Ballabh Pant University of Agriculture and Technology set up at Pantnagar, Uttar Pradesh.
1961	Fertilizer Corporation of India set up at New Delhi. Intensive Agricultural District Programme (IADP) stated in seven districts. Package of agricultural practices prepared for wheat and rice cultivation in the States. Dwarflines of wheat incorporating Norin Genes released by N.E. Borlaug at CIMMYT, Mexico. These varieties later had a major impact on India's Green Revolution.
1962	Central Sheep and Wool Research Institute started at Avikanagar, Rajasthan. Punjab Agricultural University set up at Ludhiana, Punjab (inaugurated on 8 July 1963). Orissa University of Agriculture and Technology set up at Bhubaneshwar, Orissa. Indian Grassland and Fodder Research Institute established at Jhansi, Uttar Pradesh.

(Contd.)

<i>Year</i>	<i>Events</i>
1963	<p>N.E. Borlaug visits India, On return to Mexico he sends 100 kg seed of each of the dwarf and semi-dwarf wheat varieties and 613 primary selections in advanced generation to the IARI. The IARI arranged multi-location testing programme at Delhi, Ludhiana, Pusa, Kanpur, Pantnagar, Bhowali and Wellington. Out of these, 'Kalyan Sona' was independently selected at Delhi and Ludhiana, and 'Sonalika' at Delhi.</p> <p>Central Tuber Crops Research Institute started at Trivandrum, Kerala .</p> <p>The National Seeds Corporation set up.</p>
1964	<p>Intensive Agricultural Areas Programme (IAAP) started in 114 blocks, with M.S. Randhawa as Director-General.</p> <p>C. Subramaniam appointed Minister for Food and Agriculture and Community Projects Government of India.</p> <p>India faces food crisis due to prolonged drought.</p>
1965	<p>About 250 t of wheat seed imported from Mexico.</p> <p>B.P. Pal appointed Vice-President of the ICAR. He was the first agricultural scientist to hold this post.</p> <p>Andhra Pradesh Agricultural University set up at Hyderabad, Andhra Pradesh.</p> <p>University of Agricultural Sciences set up at Bangalore, Karnataka.</p> <p>National Dairy Development Board formed at Anand, Gujarat.</p> <p>Agricultural Prices Commission established.</p> <p>Warehousing Corporation set up.</p>
1966	<p>The Report of the Education Commission (Headed by Dr. D.S. Kothari) recommends the setting up of at least one agricultural university in each State.</p> <p>Agro-industries Corporations set up in Bihar, Punjab and Tamil Nadu.</p> <p>Start of the Green Revolution.</p> <p>'Rojo 69' and 'Sonora 64' imported from Mexico.</p> <p>Neyveli Fertilizer Plant commissioned.</p>
1967	<p>Indian Institute of Horticultural Research started at Bangalore, Karnataka.</p> <p>International Rice Research Institute, Philippines, enters into an agreement with the ICAR and the USAID to participate in the development of rice research in India. This led to development of many high-yielding varieties of rice.</p> <p>All-India co-ordinated Research Project on Soybean started by the ICAR.</p> <p>C.T. Patel develops hybrid cotton, 'H 4'. Which gave a yield of 6,918 kg per hectare.</p>
1969	<p>Wealth tax imposed on agricultural land.</p> <p>Assam Agricultural University set up at Jorhat, Assam.</p> <p>Central soil Salinity Research Institute started at Karnal, Haryana.</p>
1970	<p>Central Plantain Crops Research Institute started at Kasargod, Kerala.</p> <p>Haryana Agricultural University set up at Hissar, on account of bifurcation of the Punjab Agricultural University.</p> <p>Indian Dairy Corporation started with V. Kurien as Chairman.</p> <p>Operation Flood started by the National Dairy Development Board.</p>
1971	<p>Directorate of Agricultural Aviation started by the Government of India.</p>

(Contd.)

<i>Year</i>	<i>Events</i>
	Tamil Nadu Agricultural University set up at Coimbatore.
	Rajendra Agricultural University set up at Patna, Bihar.
1972	Ceiling on Land-holdings fixed at 4–7 hectares of double-cropped land per family.
	International crops Research Institute for Semi-arid Tropics established at Hyderabad , Andra Pradesh, with R.W. Cummings as its first Director.
	Kerala Agricultural University set up at Mannuthy, Kerala.
1974	Central Soil and Water Conservation Research and Training Institute started at Dehradun.
1976	Central Institute of Agricultural Engineering started at Bhopal.
	Central Institute for Cotton Research started at Nagpur.
	National Bureau of Plant Genetic Resources set up at New Delhi.
	National Bureau of Soil Survey and Land-Use Planning started functioning independently at New Delhi; shifted to Nagpur in 1978.
	Integrated Rural Development programme started.
1977	Prakash Singh Badal appointed Minister, Food and Agriculture, Government of India.
	Surjit Singh Barnala appointed Minister, Food and Agriculture, as Parkash Singh Badal becomes Chief Minister of Punjab.
	Production of Potatoes in India rises to 7,287 thousand tones.
1978	Central Agricultural Research Institute for Andaman and Nicobar Group of Islands started at Port Blair.
1979	Brahm Parkash Choudhary appointed Minister, Food and Agriculture, Government of India.
	Central Avian Research Institute comes into being at Izatnagar, Uttar Pradesh.
1980	Ramagundam Fertilizer project completed to manufacture ammonia and urea.
	Wealth tax on agricultural lands-an iniquitous, Vexatious and anti-improvement measure-abolished.

2.45.1 Vision for Agriculture in 2020 A.D.

Every country needs a vision statement, which stirs the imagination and motivates all segments of society to a greater effort. It is an essential step in building a political consensus on a broad national development strategy, which encompasses, inter-alia, the roles and responsibilities of different agents in the economy, such as Central, State and local government, the private corporate sector, the small and tiny sector, people's organization etc. It must identify potential risks and bottlenecks and their possible solutions in order to mobilize efforts in a focused manner. It is clear, therefore, that to meet these objectives, a vision statement has to operate at several levels of generality and specificity. A vision is a picture of what is possible or what is desired in a longer-term future. It could be of one individual in origin or it could be a collective in its conception.

President A.P.J. Abdul Kalam's address to the joint session of Parliament in 2003: The people to strive towards the goal of transforming India into a Developed Nation by 2020. This vision captures our people's heightened self-confidence, rooted in India's impressive achievements in many fields. It also reflects the increased expectations of our people at the beginning of the new century, that India no longer be categorized as a developing, much less, a poor country. Nearly 260 million people, who are below the poverty line, want to join the mainstream of development. Our people are impatient to

achieve 100 percent literacy, health for all, shelter for all, prosperity through knowledge-driven productivity, and a better quality of life—all of these enriched with our value system. Hence, it is time India launched a new vision, which I would call “Vision–2020”. To achieve this, they should concentrate on two mantras: Effective Implementation with People’s Participation; and Effective Communication for People’s Participation. A key element of “Vision 2020” would be “*Providing Urban amenities in Rural Areas (PURA)*”. More than two-thirds of India’s population lives in rural areas. We need to give a new thrust to their all-round development through a mega mission for their empowerment. The richness and diversity of India’s bio-resources are a major gift of nature to us. The Biological Diversity Bill 2002, passed in the Winter Session, marked a major milestone in India’s commitment to conservation and sustainable utilization of our bio-resources. An ambitious afforestation programme with people’s participation that establishes Joint Forest Management Committees in all the 1.73 lakh villages located on the fringes of the forest areas has been launched. The scope of the National River Conservation Plan has been considerably broadened to include works in 155 towns along polluted stretches of 29 rivers spread over 17 States. India successfully hosted the Eighth Conference of Parties to the United Nations Framework Convention on Climate Change in New Delhi last year. The successful adoption of the Delhi Declaration helped to raise awareness of developing country concerns in climate change. India welcomes the adoption of the Plan of Action at the World Summit on Sustainable Development, which was held in Johannesburg last year. India’s first meteorological satellite was successfully launched. The forthcoming launches of satellites in the INSAT-3 series will add further capacity to the INSAT system, which is already one of the largest domestic communication satellite systems in Asia. An exclusive satellite for education, EDUSAT, is also under development. ISRO has taken up the task of tele-medicine connectivity to provide medical services to remote areas. The Indian Remote Sensing Satellites continue to provide valuable data for our resources survey and management. Groundwater prospect maps for six States were released recently to help locate sites for drilling bore wells.

The Nation has been searching for a lasting solution to the recurring problem of droughts and floods, which have been taking a huge human and economic toll. Networking of our river systems to transfer water from the surplus basins to the areas of deficit has engaged people’s attention for many decades. The Government has set up a Task Force to prepare a practical blueprint for this project, without compromising environmental safety and the interest of displaced people. This initiative will bring significant benefits in drinking water, irrigation, power generation, inland navigation, and tourism. I must emphasize that this mega project does not negate the need for promoting small and micro programmes for water conservation at local levels. The two are mutually complementary. The National Water Resources Council has adopted a new National Water Policy emphasizing integrated water resources development and management for optimal and sustainable utilization of available surface and groundwater. The Centre has launched a Fast Track Programme for the completion of those major and medium irrigation schemes that can be completed in one year. Subsequent to the approval by the Narmada Control Authority, the dam height was raised, and this has mitigated the problem of drinking water and irrigation in arid areas of Saurashtra and North Gujarat. The policy of procurement at the Minimum Support Price, while ensuring remunerative prices for wheat and rice farmers in surplus States, has resulted in huge stocks of rice and wheat with the public agencies. As a response to this, the Government has been encouraging exports of food grains. The wide-ranging recommendations on long-term food management made by the High Level Committee are being examined. There is an urgent need to review the current policies, which have impeded crop diversification and led to unsustainable food subsidies, and to ensure crop neutral support to our farmers without excessive procurement. Fertilizers are a critical component in our scheme of food security. The new pricing policy

for urea to be implemented from April 2003 aims at greater transparency, efficiency, and fiscal discipline. While the Government is committed to deregulate the marketing and distribution of fertilizers, it would ensure that major fertilizers are available in the country both in adequate quantity and quality at affordable prices to farmers in all the States. The sugar industry has lately faced serious difficulties, constraining the capacity of sugar factories to make timely payment to sugarcane farmers. Several steps have been initiated to protect the interests of sugarcane growers, while ensuring viability of sugar mills. Sustained efforts are being made to promote horticulture as a major area of diversification in agriculture. The cold storage scheme is working well and has created an additional capacity of 28 lakh t. A new scheme of construction, renovation, and expansion of rural godowns called Grameen Bhandaran Yojana has been launched. This scheme will help prevent distress sales by small and marginal farmers. A new National Policy on Cooperatives has been announced. A National Seeds Policy has been finalized. Under the scheme of Agriclincs and Agribusiness Centres, launched last year, unemployed agriculture graduates provide extension services to the farmers on payment. Recognizing the need for value-addition in agricultural and horticultural produce, the Government has given high priority to the development of food processing industries. A Group of Ministers has been constituted to propose a single modern integrated food law and related regulations, to replace the existing myriad laws, which have affected the growth of this sector.

A. Agricultural Education in India

Greater coverage and better quality education at all levels from basic literacy to hi-tech science and technology is the essential prerequisite for raising agricultural productivity. The Education Division is headed by the Deputy Director General (Education). Five Assistant Directors General (ADGs)-ADG (HRD-I), ADG (HRD-II), ADG (Education Planning and Development), ADG (Accreditation), ADG (Home Science), and Deputy Secretary (Education), assist the DDG (Edn). Each is supported by a Section Officer (SO) and other staff. The Examination Cell established to conduct All India Entrance Examination is functioning under a revolving fund scheme from the current financial year, and is headed by ADG (HRD-I). The Education Division provides administrative support to the National Academy of Agricultural Research Management (NAARM).

B. Thrust Areas

- Accreditation for quality assurance.
- Global competitiveness in HRD.
- Distance education for reaching the unreached.
- Fellowship as a tool for HRD, National integration and reducing inbreeding.
- Women technological empowerment.
- Faculty competence improvement.
- Networking for access to information.

“A developed country is one which is able to utilize its core strength to the best possible extent. If a country is not able to use its core strengths or is underutilizing its core strengths it remains underdeveloped”. Utilization of core strengths is finally the utilization of strengths of its people. Empowering each Indian with right skills and knowledge (to enable him/her to add value addition) is crucial for national development. If people are poor, it is because they have not been empowered with right skills, which can provide value addition in the competitive world of market economics.

We cannot afford to ignore the rights of our children to live prosperously in a world which is going to pay only those who have the right skills. Education and skill imparting is not a slot machine—it

requires gestation periods for a person who enters it to come out with reasonable skills and knowledge base. So we need to bold in our approach to expand skill and knowledge delivery systems to our people on a massive scale to enable them to be productive in a competitive globalised world. That will in turn and would also spread entrepreneurship thus creating a virtuous cycle of economic acceleration and knowledge-skill base growth.

C. Agricultural Research in India

The research thrust areas identified for immediate future are:

- Increasing the productivity of crops
- Micro-propagation of agricultural and horticultural plants through tissue culture techniques, biotechnology, etc.
- Forage crops for various agro climatic regions
- Achieving sustainable agriculture through integrated farming systems, integrated nutrient management, biofertilizers, etc.
- Optimal cropping system in accordance with resource base in dry land agriculture
- Organic farming
- Wasteland development through agro forestry, agri-horticulture, silvipasture, insitu soil moisture conservation, and technologies for problem soils
- Evolving eco-friendly, low cost technologies including biopesticides and biocontrol agents
- Production of quality seeds of agricultural and horticultural crops including hybrids seeds
- Strengthening post harvest research and protected cultivation from crop produce losses
- Developing suitable farm machineries and tools to manage labour scarcity in farm operations
- Strengthening research on new irrigation methods, developing drought tolerant crop varieties to manage water scarcity
- Developing low cost packing and processing technologies to agricultural and horticultural commodities
- Non-conventional energy resources
- Research on productivity and processing of medicinal plants. Commercial exploitation of medicinal plants in domestic and foreign markets
- Setting of agri-clinics and agri-business centres in areas such as soil, water quality and input laboratory service centre, plant protection, horticulture, marketing, farm machinery and primary processing, etc.

The Department of Biotechnology (DBT) has unveiled a document “Biotechnology-A Vision”. The document outlines time-bound mission oriented inter-agency, inter-disciplinary projects to achieve the objectives. The mission would be a well-directed effort for the generation of products, processes and technologies to provide food, environment, health and nutritional security. India and Switzerland have taken up a wheat research programme to develop high-yielding improved varieties, resistant to fungal diseases. The DBT and the Indian Council of Agricultural Research (ICAR) are working towards a Swiss proposal for joint research on Golden Rice *i.e.*, a pro-vitamin-A rich rice variety. Collaborative arrangements have also been entered into with the National Institute of Mental Health, USA and the Brain Research Centre, Riken, Japan, for research in neuro-sciences. There is a major mission for technology for bamboo products recently approved. This will greatly facilitate rural poor to earn through selling bamboo with value addition.

D. National Textile Policy

Deciding to redefine the goals and objectives, focus on thrust areas and sharpen strategy in tune with the times, the National Textile Policy–2000 is enunciated as follows: The Indian Textile Industry shall be the policy to produce cloth of good quality at acceptable prices to meet the growing needs of the people; increasingly contribute to the provision of sustainable employment and the economic growth of the nation; and compete with confidence for an increasing share of the global market. The strategic thrust areas will be on technological upgradation, enhancement of productivity, quality consciousness, strengthening of the raw material base, product diversification, increase in exports and innovative marketing strategies, financing arrangements, maximizing employment opportunities and integrated human resource development. The important endeavour will be to achieve increase in cotton productivity by at least 50% and upgrade its quality to international standards, through effective implementation of the Technology Mission on Cotton; launch the Technology Mission on Jute to increase productivity and diversify the use of this environment-friendly fibre; strengthen and encourage the handloom industry to produce value added items and assist the industry to forge joint ventures to secure global markets; facilitate the growth and strengthen HRD Institutions including NIFT (National Institute of Fashion Technology) on innovative lines; review and revitalize the working of the TRAs (Textile Research Associations) to focus research on industry needs. The textile sector is grappling with the challenges of a globalized market and problems created by slow modernization. Nine Apparel Parks have been sanctioned for setting up garment units with state-of-the-art machinery. Several new schemes have been approved to improve facilities in major textile centres in the country. At the same time, the problems of the traditional handloom and handicraft sectors, which provide livelihood to vast numbers of our weavers and artisans, are also being comprehensively addressed through a special package of measures.

E. Agricultural Extension in India

The farming community needs to increase their productivity through the mission Second Green Revolution using technological advances. Also dry land cultivation needs a thrust. The technology is the base item for the action plan to bring India into a developed nation in reality. Grooming ‘technology’ from seed up to a fruit-bearing tree is an art, science and a specialized enterprise in itself. The key to success lies in assessing where, when and how to facilitate entry for money in the process of technological project realization. There are many other prior activities, which need to be done if technology development can mature into a good business activity. Another important development was that in addition to rapid spreading of interest within the actual farmers, the whole community (in the benefited areas) got involved. For example, a women ‘Self Help Group’ is being formed for certain joint cooperative efforts for better quality of life.

Farmers get considerable earnings (and substantial returns on their investment in Agro processing) per hectare. Stabilizing the agro technologies for the well chosen (market sharewise) medicinal herbs and placing them in the correct places of value chain. Ever since the Agreement on Agriculture of the World Trade Organization (WTO) began to be debated in the country, increasing agricultural productivity and improving food quality are being tossed as the only solutions for farmers’ survival. Invariably, at every conference and seminar on WTO, the common refrain is that farmers are left with no choice but to increase productivity and thereby reduce the cost of production to remain competitive in a globalised world. The productivity bug has bitten not only the agricultural scientists but also the policy-makers, planners and, of course, the politicians.

Crops and Crop Production

In general, crop is an organism grown or harvested for obtaining yield. Agronomically, crop is a plant cultivated for economic purpose.

3.1 CLASSIFICATION OF CROPS

Classification is done to generalize similar crop plants as a class for attaining better understanding of them. Field crops are classified in the following ways.

- According to range of cultivation
- According to the place of origin
- Botanical classification
- Commercial classification
- Economic/Agricultural/Agrarian classification
- Seasonal classification
- Classification based on ontogeny
- According to cultural requirement
- According to important uses

3.1.1 Range of Cultivation

- (a) **Garden crop** - Grown on a small scale in gardens. *e.g.*, Onion, Brinjal etc.
- (b) **Plantation crop** - Grown on a large scale in estates and perennial in nature. *e.g.*, Tea, Coffee, Cacao, Rubber etc.
- (c) **Field crop** - Grown on a vast scale under field condition. They are mostly seasonal such as rice, wheat, cotton etc.

3.1.2 Place of Origin

- (a) **Native** - Crops grown within the geographical limits of their origin, for *e.g.*, rice, barely, black gram, green gram, mustard, castor, sugarcane and cotton, grown in India, are native to India.
- (b) **Exotic or Introduced** - Crops introduced from other countries, such as tobacco, potato, jute, maize, apple, etc.

3.1.3 Botanical/Taxonomical Classification

According to systematic botany plants are classified as order, family etc. Similarly crop plants are grouped into families as,

(a)	<i>Poaceae (Graminae)</i>	:	Cereals, millets and grasses
(b)	<i>Papilionaceae (Legumes)</i>	:	Pulses, legume fodders, vegetables, groundnut, berseem, green manures etc.
(c)	<i>Cruciferae</i>	:	Mustard, Indian rape seed, radish cabbage, cauliflower etc.
(d)	<i>Cucurbitaceae</i>	:	All gourds, cucumber, pumpkin etc.
(e)	<i>Malvaceae</i>	:	Cotton, lady's finger, Roselle etc.
(f)	<i>Solanaceae</i>	:	Potato, tomato, tobacco, chillies, brinjal
(g)	<i>Tiliaceae</i>	:	Jute
(h)	<i>Asteraceae (Compositae)</i>	:	Sunflower, safflower, niger
(i)	<i>Chenopodiaceae</i>	:	Spinach, sugar beet
(j)	<i>Pedeliaceae</i>	:	Sesame
(k)	<i>Euphorbiaceae</i>	:	Castor, tapioca
(l)	<i>Convolvulaceae</i>	:	Sweet potato
(m)	<i>Umbelliferae</i>	:	Coriander, cumin, carrot, anise
(n)	<i>Liliaceae</i>	:	Onion, garlic
(o)	<i>Zingiberaceae</i>	:	Ginger, turmeric

3.1.4 Commercial Classification

Based on the plant products which come into the commercial field are grouped as:

- (a) **Food crops:** Rice, wheat, green gram, soybean, groundnut, etc.
- (b) **Food crops/Forage crops:** All fodders, oats, sorghum, maize, napier grass, stylo, Lucerne etc.
- (c) **Industrial/Commercial crops:** Cotton, sugarcane, sugar beet, tobacco, jute, etc.
- (d) **Food adjuvants:** Turmeric, garlic, cumin, etc.

3.1.5 Economic/Agrarian/Agricultural Classification

This classification is based on use of crop plants and their products. This is an important classification as far as agronomy is concerned (*Agronomic classification*) (For botanical names of crops, refer annexure-II).

- (a) **Cereals** - They are cultivated grasses grown for their edible starchy grains (one seeded fruit-caryopsis). Larger grains used as staple food are cereals—rice, wheat, maize, barley, oats etc. The word cereal was derived from the word *ceres*, which denotes a goddess who was believed as the giver of grains by Romans.

rice, wheat

Bread wheat	-	<i>Triticum aestivum, Triticum vulgare</i>
Macaroni wheat	-	<i>T. durum</i>
Emmer wheat	-	<i>T. dicoccum</i> (Mysore and Nilgiri)
Bean	-	Var. lignosus

maize, barley and oats

- (b) *Millets* - Small grained cereals, which form the staple food in drier regions of the developing countries, are called millets. *e.g.*
Major - Sorghum, pearl Millet or cumbu and finger millet or ragi.
Minor - Fox tail millet, little millet, common millet, barnyard millet and kodomillet
- (c) *Oil seeds* - Crops that yield seeds rich in fatty acids, are used to extract vegetable oils. *e.g.*, groundnut or peanut, sesamum or gingelly, sunflower, castor, linseed or flax, niger, safflower, mustard and cotton.
- (d) *Pulses* - Seeds of leguminous plants used as food. They produce dal rich in protein. *e.g.*, red gram, black gram, green gram, cowpea, bengal gram, horse gram, dew gram, soybean, peas or garden pea and garden-bean.
- (e) *Feed/Forage* - It refers to vegetative matter, fresh or preserved, utilized as feed for animals. It includes hay, silage, pasturage and fodder. *e.g.*, bajra napier grass, guinea grass, fodder-sorghum, fodder-maize, lucerne, desmanthus, etc.
- (f) *Fibre crops* - Plants grown for their fibre yield. There are different kinds of fibre. They are:
(i) seed fibre—cotton, *(ii)* stem fibre—jute, mesta, *(iii)* leaf fibre—agave, pineapple.
- (g) *Sugar and starch crops* - Crops grown for production of sugar and starch. *e.g.*, sugarcane, sugar beet, potato, sweet potato, tapioca and asparagus.
- (h) *Spices and condiments* - Crop plants or their products used to season, flavour, taste, and add colour to the fresh or preserved food. *e.g.*, ginger, garlic, fenugreek, cumin, turmeric, chillies, onion, coriander, anise and asafetida.
- (i) *Drug crops/medicinal plants* - Crops used for preparation of medicines. *e.g.*, tobacco, mint etc.
- (j) *Narcotics, fumitories and masticatories* - Plants/products used for stimulating, numbing, drowsing or relishing effects. *e.g.*, tobacco, ganja, opium poppy.
- (k) *Beverages* - Products of crops used for preparation of mild, agreeable and stimulating drinking. *e.g.*, tea, coffee, cocoa.

3.1.6 Seasonal Classification

Crops are grouped under the seasons in which their major field duration falls.

- (a) *Kharif or South West Monsoon season crops* - Crops grown during June–July to September–October, which require a warm wet weather during their major period of growth and shorter day length for flowering. *e.g.*, rice, maize, castor and groundnut.
- (b) *Rabi crops/post monsoon crops* - Crops grown during October–November to January–February, require cold dry weather for their major growth period and longer day length for flowering. *e.g.*, wheat, mustard, barley, oats, potato, Bengal gram, berseem, cabbage and cauliflower.
- (c) *Zaid or summer crops* - Crops grown during February–March to May–June which requires warm dry weather for growth and longer day–length for flowering. *e.g.*, black gram, green gram, sesame, cowpea etc.

This classification is not a universal one. It only indicates the period when a particular crop is raised. *e.g.*, kharif rice, kharif maize, rabi maize, summer pulse etc.

3.1.7 According to Ontogeny

It is a classification based on the life cycle of a plant.

- (a) *Annual crops* - Crop plants that complete life cycle within a season or year. They produce seed and die within the season. *e.g.*, wheat, rice, maize, mustard.

- (b) *Biennial crops* - Plants that have life span of two consecutive seasons or years. First year/Season these plants have purely vegetative growth usually confined to rosette of leaves. The tap root is often fleshy and serves as a food storage organ. During the second year/season they produce flower stocks from the crown and after producing seeds the plants die. *e.g.*, sugar beet, beet root, cabbage, radish, carrot, etc.
- (c) *Perennial crops* - They live for three or more years. They may be seed bearing or non-seed bearing. *e.g.*, sugarcane, napier grass. In general perennial crops occupy land for more than 30 months.

3.1.8 According to Cultural Requirement of Crops

Certain group of plants is alike in cultural requirements due to their similar agro-botanical or morpho agronomical characters.

A. According to suitability of toposequence

- (i) **Crops grown on upland** - Levelled elevated land with drain all around or unbunded levelled land with drains or drops. Crops that cannot tolerant water stagnation come under this group. *e.g.*, red gram, groundnut, maize, sorghum, cotton, sesamum, napier etc. Crops that require sufficient soil moisture but cannot tolerate water stagnation. *e.g.*, Potato, sugarcane, upland rice, ragi, wheat, black gram, Bengal gram.
- (ii) **Crops grown on lowland** - These lands are provided with dykes or bunds all around to stagnate water. Crops that require abundant supply of water and can withstand prolonged water logged conditions. *e.g.*, rice, daincha, Para grass and jute.

B. According to source of water

- (i) **Irrigated crops** - The crop cultivation primarily depends upon the irrigation water for a part/ entire growth period of the crop. All crops irrespective seasons are possible to be raised in this category.
- (ii) **Rainfed crops** - The crop cultivation entirely depends upon the rainfall received. Crop varieties depend upon the season and the rainfall pattern.

C. According to moisture availability the soil

- (i) **Wet lands** - The soil moisture is allowed to occupy both macro and microspores. Anaerobic field condition prevails here. Crops suitable are those crops, which tolerate water stagnation. *e.g.*, green manures like sesbania group, grasses etc.
- (ii) **Dry lands** - The soil moisture is allowed only on to microspores. Macro pores are filled with air. Magnitude of soil moisture varies according to the crop. Crops like maize, highly sensitive to excess moisture and drought, crops tolerant to drought and temporary stagnation, sorghum are cultivated in this type of field condition.

D. According to the suitability of the textural groups of soils

- (i) **Crops suitable to sandy to sandy loam (light) soils** - Sorghum, bajra, green gram, sunflower, potato, onion, carrot etc.
- (ii) **Crops suitable to silty loam (medium) soils** - Jute, sugarcane, maize, cotton, mustard, tobacco, bengal gram, red gram, cowpea, etc.
- (iii) **Crop suitable to clay loam (heavy) soils** - Rice, wheat, barley, linseed, lentil, para grass, guinea grass, marvel grass etc.

E. According to tolerance to problem soils

- (i) **Tolerant to acidic soils** - Wet rice, potato, mustard.
- (ii) **Tolerant to saline soils** - Chillies, cucurbits, wheat, sorghum, bajra, cluster beans, barley etc.
- (iii) **Tolerant to alkali/sodic soils** - Barley, cotton, bengal gram, berseem, sunflower, maize, etc.
- (iv) **Tolerant to waterlogged soils** - Wet rice, daincha, para grass, napier grass, guinea grass.
- (v) **Crops tolerant to soil erosion** - Marvel grass, groundnut, black gram, rice bean, moth bean, and horse gram.

F. According to tillage requirement

- (i) **Arable crops** - Require preparatory tillage. *e.g.*, Potato, tobacco, rice, maize.
- (ii) **Non-arable crops** - May not require preparatory cultivation/tillage. *e.g.*, para grass.

G. According to the depth of root system

- (i) **Shallow rooted crops** - Rice, potato, and onion.
- (ii) **Moderately deep rooted** - Wheat, groundnut, castor, and tobacco.
- (iii) **Deep rooted** - Maize, cotton, and sorghum.
- (iv) **Very deep rooted** - Sugarcane, safflower, lucerne, and red gram.

H. According to the tolerance to hazardous weather condition

- (i) **Frost tolerant** - Sugar beet, beet root.
- (ii) **Cold tolerant** - Potato, cabbage, and mustard.
- (iii) **Drought tolerant** - Bajra, jowar, barley, safflower, castor.

I. According to method of sowing/planting

- (i) **Direct seeded crop** - Where the seeds are sown directly either dry or sprouted. upland rice, wheat, jowar, bajra, groundnut etc.
- (ii) **Planted crops** - Where plant parts are planted directly. *e.g.*, sugarcane, potato, sweet potato, napier, guinea grass.
- (iii) **Transplanted crops** - Where seedlings are raised in the nursery, pulled out and planted in the field: rice, ragi, bajra, tobacco, bellary onion, brinjal.

J. According to inter-tillage requirement specially earthing up

- (i) **Intertilled crops** - Potato, sweet potato, groundnut, maize, sugarcane, and turmeric.
- (ii) **Non-intertilled crops** - Fodder sorghum, deenanath grass, para grass etc.

K. According to length of field duration of crops

- (i) Very short duration crops (upto 75 days) : pulses
- (ii) Short duration crops (75–100 days) : sunflower, cauliflower, upland rice
- (iii) Medium duration crops (100–125 days) : wheat, jowar, bajra, groundnut, sesame, jute
- (iv) Long duration crops (125–150 days) : mustard, tobacco, cotton
- (v) Very long duration crops: above 150 days : sugarcane, red gram, castor.

L. According to the method of harvesting

- (i) Reaping : rice, wheat,
- (ii) Uprooting by pulling : bengal gram, black gram, lentil, rapeseed
- (iii) Uprooting by digging : potato, sweet potato, groundnut, carrot etc.

- | | | |
|---------------|---|---|
| (iv) Picking | : | cotton, vegetables, brinjal, bhendi, chillies |
| (v) Priming | : | tobacco |
| (vi) Cutting | : | berseem, napier, amaranthus |
| (vii) Grazing | : | para grass, kolukkattai grass, and stylo. |

M. According to post harvest requirement

- | | | |
|--------------------------|---|---------------------------------------|
| (i) Curing | : | tobacco, mustard |
| (ii) Stripping | : | jute, sunnhemp |
| (iii) Shelling | : | groundnut |
| (iv) Ginning | : | cotton |
| (v) Seasoning | : | turmeric, chillies |
| (vi) Grading and sorting | : | potato, rice, wheat, fibre crops etc. |

N. Based on crops growing soil condition

- | | | |
|---------------------------------|---|---------------------|
| (i) Psammophytes (Sandy soil) | : | castor |
| (ii) Lithophytes (Rock surface) | : | ferns |
| (iii) Chasmophytes (Rock crack) | : | potato |
| (iv) Acedophytes (Acid soil) | : | potato |
| (v) Basophytes (Alkali soil) | : | rice |
| (vi) Calciphytes (Basic soil) | : | asparagus |
| (vii) Halophytes (Saline soil) | : | sugar beet, alfalfa |

O. Based on climatic condition

- | | | |
|------------------------|---|----------------------------|
| (i) Tropical crop | : | coconut, sugarcane |
| (ii) Sub-tropical crop | : | rice, cotton |
| (iii) Temperate crop | : | wheat, barley |
| (iv) Polar crop | : | all pines, pasture grasses |

3.1.9 According to Important Uses

Though plants are useful in many ways only certain uses are given below.

- (a) **Catch crops/contingent crops** are those crops cultivated to catch the forth coming season. It replaces the main crop that has failed due to biotic or climatic or management hazards. Generally, they are of very short duration, quick growing, harvestable or usable at any time of their field duration and adaptable to the season, soil and management practices. They provide feed, check weed growth, conserve soil, utilized added fertilizer and moisture. *e.g.*, green gram, black gram, cowpea, onion, coriander and bajra.
- (b) **Restorative crops** are those crops, which provide a good yield along with enrichment or restoration of soil fertility or amelioration of the soils. They fix atmospheric nitrogen in root nodules, shed their leaves during ripening and thus restore soil conditions. *e.g.*, legumes.
- (c) **Exhaustive crops** are those crop plants, which on growing leave the field exhausted because of a more aggressive nature. *e.g.*, gingelly, brinjal, linseed, sunflower etc.
- (d) **Paira crop/residual crops** are those crop plants which are sown a few days or weeks before the harvest of the standing mature crops to utilize the residual moisture, without preparatory tillage. The standing crop and the later sown (paira) crop become simultaneous (forming a pair) for a short period. For *e.g.*, rice fallow pulses black gram, lathyrus, lentil etc. Paira crops in succession may constitute relay cropping.

- (e) **Smother crops** are those crop plants which are able to smother or suppress the weed growth by providing suffocation (curtailing movement of air) and obscuration (of the incidental radiation) through their dense foliage developed due to quick growing ability with heavy tillering or branching, planophyllic or procumbent or trailing habits. *e.g.*, barley, mustard, cowpea, etc.
- (f) **Cover crops** are those crop plants, which are able to protect the soil surface from erosion (wind, water or both) through their ground covering foliage and or root mats. *e.g.*, groundnut, black gram, marvel grass, sweet potato.
- (g) **Nurse crops**: A companion crop, which nourishes the main crop by way of nitrogen fixation and or adding the organic matter into the soil. *e.g.*, cowpea intercropped with cereals, glyricidia, tephrosia in tea.
- (h) **Guard/barrier crops** are those crop plants, which help to protect another crop from trespassing or restrict the speed of wind and thus prevent crop damage. Main crop in the centre surrounded by hardy or thorny crop. *e.g.*, mesta around sugarcane; sorghum around cotton; safflower around gram.
- (i) **Trap crops** are those crop plants grown to trap soil borne harmful parasitic weeds. For *e.g.*, orabanche and striga are trapped by solanaceous and sorghum crops respectively. Nematodes are trapped by solanaceous crops (On uprooting crop plants, nematodes are removed from the soil). Castor in cotton, groundnut act as crop for army worm pest.
- (j) **Augmenting crops** are those sub crops sown to supplement the yield of the main crop. *e.g.*, Mustard or cabbage with berseem to augment the forage yield of berseem.
- (k) **Alley crops** are those arable crops, which are grown in 'alleys' formed by trees or shrubs, established mainly to hasten soil fertility restoration, enhance soil productivity and reduce soil erosion. They are generally of non-trailing with shade tolerance capacity. For *e.g.*, growing pulses in between the rows of casuarina.

3.2 CROP ADAPTATION AND DISTRIBUTION

3.2.1 Adaptation

Adaptation may be defined as any feature of an organism, which has survival value under the existing condition of its habitat. Such features or feature may allow the plants to make fuller use of nutrients, water, temperature or light available or may give protection against adverse factors such as temperature extremes, harmful insects and diseases. Adaptation may be morphological or physiological.

- (a) **Morphological adaptation** such as growth habit, strength of stalk, radial symmetry, or rhizomes.
- (b) **Physiological adaptation**, which result in resistance to parasites, greater ability to compete for nutrients or ability to withstand desiccation. However both morphological and physiological adaptation represents the expression of physiological processes.

3.2.2 Principles of Plant Distribution

Environmental factors are highly influential in determining the natural distribution of plants.

There are eight principles of plant distribution

- Evolution
- Climatic factors like light, temperature, moisture, wind etc.
- Edaphic factors like soil, parent material, physiography
- Dispersal of flora

- Plant migrations
- Climatic variations or change
- Relative distributions of land and sea (occurrence in geological time) and it exerts a high degree of control over distribution of flora
- Biotic factors like obligate insect pollination, seed dissemination by animals and grazing by live stock directly influence the plant distribution.

3.2.3 Theories Governing Crop Adaptation and Distribution

Theory of tolerance - Each plant or living organisms is able to thrive well in certain climatic conditions below which and above which the plant can't grow, *i.e.*, it requires optimum climatic conditions. Temperature is one of the most common limiting factors in plant distribution. Many tropical crops such as rubber, cocoa, banana will not with stand freezing temperature (0°C). In these rubber probably has the narrowest tolerance range and banana the widest range for temperature tolerance.

Theory of avoidance - It may be accomplished through rapid completion of the life cycle, as in ephemerals, dormancy in seeds to avoid effects of the hottest and driest periods, dormancy in vegetative parts or roots of all the perennials, water accumulation in succulents and extremely deep root systems to avoid moisture deficiency.

Theory of factors replaceability - One factor that can be replaced by another or substituted by another. For *e.g.*,

- Elevation can be substituted for latitude because of its temperature effects. The climatic conditions at the latitudes of 35–45° N resembles to that of tropical regions at elevation of 4000–6000 ft.
- The angle direction of slope may be substituted for latitude. This is also a temperature adjustment, depending on the angle of exposure to solar radiation, wind etc.
- Parent materials may compensate for climate.
- Rainfall may be replaced by fog and to some extent by dew.
- Soil texture may be substituted for moisture.

3.2.4 Major Crops of Indian Sub-continent

The packages and practices of different crops are given in the chapter 15. The origin, adaptation, altitude, rainfall and temperature, soil and distribution of different crops are given below.

1. **Rice** - In India rice is the most important food crop and it is the staple food in tropical and subtropical regions of Asia and Africa.

Origin: Indo-Burma (Indo-Myanmar).

Adaptation: Grown in the world between 39°S (Australia) 50°N latitude (China). In India it is grown between 8°N to 34°N latitude.

Altitude: From below sea level (Kuttanad region of Kerala) to 3000 m (Jammu and Kashmir) above MSL.

Rainfall and Temperature: Rice is classified as a hydrophyte. A heavy rainfall (R.F.) of 125 cm is required during its growing period. There should be a monthly R.F. of 200 mm to grow lowland rice and 100 mm to grow upland rice respectively. Deep water rice requires one meter height of standing column of water. Rice requires high humidity and high temperature (18–32°C). The critical mean temperature for flowering and fertilization is 16–20°C.

Soil: Though rice can be grown in variety of soils, ideal soil is heavy alluvial soils of river valley and delta. The best is soils with slightly acidic nature 5.5 to 6.5 pH, but rice is commonly grown in soils of 4.5 to 8.5 pH. Rice is also grown in acidic peaty soils of Kerala with pH of 3.0 and

highly alkaline soils of Punjab and Haryana with pH 10.0.

Distribution: Rice is widely distributed in India, Pakistan, Bangladesh, Malaysia, Taiwan, China, Japan, Australia, USA, Spain, Korea. In India rice is grown in the states of Tamil Nadu, Kerala, Bihar, Uttar Pradesh, Madhya Pradesh, West Bengal, Orissa, Andhra Pradesh etc.

2. **Wheat** - Wheat is the most important and widely cultivated crop in the world. It occupies a prime position in terms of production. India ranks second in production next to China. In India, wheat is the second most important food crop next to rice.

Origin: Central Asia.

Cultivated species

Common/bread wheat—95% production.

Durum/macaroni/samba wheat—3-4% production.

Emmer wheat—1% production

Indian dwarf wheat—less than 1% production

Distribution: Widely distributed in USSR, China, USA, Switzerland, France, Germany, India etc. In India wheat is grown in the states of Uttar Pradesh, Madhya Pradesh, Punjab, Rajasthan, Bihar, Haryana, Maharashtra and Gujarat.

Adaptation: It can be cultivated from sea level to as high as 3,300 m above MSL.

Climate: Cool winter and dry hot summer is required. Wheat requires a rainfall of 40–90 cm. But high temperature and high humidity are harmful.

Soils: Though grown in wide range of soil, well drained loams and clay loams are better suited. It is grown in soils with pH above 5.8 and the most suitable pH is 6.5–7.5.

Seasons

Winter wheat: Long duration wheat varieties are grown in this season, which require low temperature during early growth for flowering and fruiting. It is grown from October, November to May, July.

Spring wheat: These varieties do not require low temperature for flowering the fruiting. Normally grown from March, May to August, September.

In India, spring wheat is grown in winter (October, November to March, April). There are two seasons for wheat in hills of Tamil Nadu (i) October–April, and (ii) May–September.

Wheat zones of India

1. North Western plains, 2. North Eastern plains, 3. Central zone, 4. Peninsular zone.

3. **Maize** - It is a multipurpose cereal, grown in USA, Brazil, China, Mexico, India and Canada. In India it is grown in states of Uttar Pradesh, Madhya Pradesh, Bihar, Rajasthan, Punjab, Karnataka, Himachal Pradesh. It requires a mean temperature of 24°C and night temperature more than 15°C. Summer temperature below 19°C is not suitable. It requires a well distributed rainfall of 50–75 cm. It can be grown from sea level to 3000 m above MSL.

4. **Sorghum (Jowar)** - It is a cereal crop for food in underdeveloped countries and it is grown in USA, China, Nigeria, Sudan and Argentina. In India, it is grown in states of Maharashtra, Andhra Pradesh, Karnataka, Gujarat, Madhya Pradesh, Tamil Nadu, Rajasthan and Uttar Pradesh. The Temperature requirement is minimum 8 to 10°C, optimum 26-29°C and maximum 35-40°C. Sorghum can tolerate high temperature throughout its life cycle better than any other cereal crops. Sorghum can tolerate drought condition. Because (a) it remains dormant during moisture

stress and resumes growth when favourable condition reappear, and (b) it possesses (i) high resistance to desiccation, (ii) low transpiration rate, and (iii) largest number of fibrous roots.

5. **Chick pea/Bengal gram** - It is number one pulse in area, production and economic importance in India. It is grown in India, Pakistan, Ethiopia, Burma, Turkey. In India, it is grown in states of Madhya Pradesh, Uttar Pradesh, Rajasthan, Punjab, Haryana and Maharashtra. It is a winter season crop but severe cold and frost are injurious to it. It requires a moderate rainfall of 60-90 cm.
6. **Pigeonpea (arhar)** - A pulse crop of India with high demand. It is the second most important pulse crop of India and foremost in Southern India. It is a crop with great resilience and withstands water stress and association of short duration crops without any considerable adverse effect on yield. It is grown as pure crop, intercrop border crop etc.
7. **Groundnut (peanut)** - It is an introduced important oilseed crop of India. It is a tropical crop grown in India, China, U.S.A. and Brazil. In India, it is grown in the states of Gujarat, Andhra Pradesh, Tamil Nadu and Punjab. It is grown between 45°N and 30°S latitude with R.F: 370-600 mm, minimum temperature: 14-16°C and optimum temperature : 21-26.5°C.
8. **Sunflower** - It is also an important oil seed crop of India. It requires a rainfall of 380 mm in summer and 550 mm in sandy loam soils. Sunflower has a heliotropic response. It is grown in U.S.A, Argentina, Romania, Spain, Yugoslavia, Turkey and former USSR countries. Being thermo and photo insensitive it can be grown throughout the year.
9. **Mustard** - An oilseed of Indian origin. It is grown in India, China, Pakistan and Bangladesh. In India, it is grown in Uttar Pradesh, Madhya Pradesh, Rajasthan, Punjab, Haryana, Bihar, Orissa, West Bengal and Gujarat. It requires cool climate and rainfall of 35-45 cm.
10. **Cotton** - It is a fibre crop of commercially important and an industrial crop. It is grown in India, U.S.A, former USSR countries, China, Brazil, Egypt, Pakistan, Mexico, Turkey and Sudan. In India, it is grown in Maharashtra, Gujarat, Karnataka, Andhra Pradesh, Tamil Nadu, Punjab, Rajasthan, Haryana and Uttar Pradesh. Cotton is a heat loving plant requires a minimum rainfall of 175-200 mm (well distributed). It requires a minimum of 180-200 frost free days.
11. **Jute** - It is also a fibre crop. It is grown in India, Bangladesh, China, Thailand, Brazil, Peru, Burma, Nepal and Vietnam. In India, it is grown in West Bengal, Bihar, Orissa, Uttar Pradesh, Meghalaya and Tripura. It requires an optimum temperature of 25-38°C, rainfall of 150 cm/annum and relative humidity of 55-90%.
12. **Tobacco** - It is grown in India, China and USA. In India, it is grown in Andhra Pradesh, Gujarat, Karnataka, Tamil Nadu, Orissa, West Bengal, Bihar, Maharashtra and Uttar Pradesh. It is a day neutral plant. It requires a rainfall of 500 mm and 90-120 frost free days. The temperature requirement is, minimum temperature 13-14°C, Optimum temperature 27-32°C and maximum temperature 35°C.
13. **Sugarcane** - It is an important commercial cash crop, grown in India, Cuba, Brazil, Mexico, Pakistan, China, Philippines, Thailand and USA. In India, it is grown in the states of Andhra Pradesh, Gujarat, Orissa, West Bengal, Bihar, Maharashtra, Karnataka and Tamil Nadu. (It is grown in 30°N-30°S latitude) Frost causes injury to sugarcane buds. It requires an annual rainfall of 1250-2500 mm. It is a short day plant, flowering can be photoperiodically controlled. It requires an optimum temperature of 26-32°C for growth.
14. **Potato** - Being a crop of temperate crop, requires a cool temperature. Ideal temperature for vegetative growth is 24°C and that for tuberisation is 18-20°C. It is susceptible to frost and requires bright sunny weather. High humidity coupled with cloudy days is injurious to potato because the crop is attacked by fungal diseases (late blight).

- 15. Sugar beet** - It is grown in former USSR countries, USA., France, Germany, Italy, Turkey, Poland, Czechoslovakia etc. In India, it is grown in Jammu and Kashmir, Punjab, Rajasthan, Uttar Pradesh and Maharastra. It requires an optimum temperature of 20–22°C and maximum temperature of 30°C and the crop is highly tolerant to frost and cold.
- 16. Banana** - It is grown in India, Taiwan, Equator, Coasto rica, Panama, Mexico, Ivory coast, Columbia and Guatemala. In India, it is grown in Tamil Nadu and Kerala. It is grown with rain fall of 1800–2500 mm. It requires a minimum temperature of 8–9°C and optimum temperature of 24–29°C.

3.2.5 Factors Governing Choice of Crop and Varieties

(i) Climate

(a) Seasons

Kharif season crops: Rice, maize, sorghum, bajra, ragi, minor Millets.

Rabi season crops: Wheat, barley, oats, chickpea, sorghum, potato, safflower, rapeseed and mustard.

Summer season crops: Gingelly, black gram, green gram.

(b) Rainfall

(i) > 30 cm/month for at least 3 months	rice
(ii) 20-30 cm/month for not less than 3 months	maize/black gram
(iii) 10-20 cm/month for at least 3 months	bajra, small millets
(iv) Rainfall 5-10 cm/month	grasses
(v) < 5 cm	Not suited for crop production

(c) Length of crop season

<i>Effective crop growing period</i>	<i>cropping system</i>
< 20 weeks	Sole crop
20-30 weeks	Sole crop + Inter crop
> 30 weeks	Two crops in sequence

(ii) Natural resources

(a) **Soil** - Cropping pattern is governed by rainfall and soil characteristics.

<i>Rainfall (mm)</i>	<i>MHC-moisture holding capacity of soil (mm)</i>	<i>cropping pattern</i>
<350	–	Not suited for crop production
350-650	100	Single crop
650-750	100	Intercropping
750-900	150	Sequential cropping (Relay cropping)
>900	200	Double cropping assured

(b) **Irrigation facilities/water** - According to water release in the canal it is decided whether single (late release of water) or double crop (early release of water) can be grown in a year. Depending upon the availability of water from river, canal or well source the crops are selected based on

their water requirement. For *e.g.*, the following is the water requirement of some crops; Banana 2000-2200 mm; Rice 1100-1150 mm; Sorghum 400-450 mm; Cotton 550-650 mm.

- (iii) **Socio-economic aspects of the farmer** - Big farmers and rich farmers can purchase inputs like fertilizers, pesticides and apply in time, but poor small and marginal farmers cannot do so. Education status, knowledge about principles and practices of crop production, technological know-how and skill also plays a major role in crop selection and management.
- (iv) **Marketing facilities** - Mostly marketing facilities are available near the town, cities and agro based processing industries. Farmers prefer a crop, the produce of which will fetch high price in the market. In earlier days sunflower and soybean were grown in limited areas due to lack of processing industry. Now, due to industrial development they are grown in large scale.
- (v) **Economics** - The ultimate objective of commercial farming is to produce more produce per rupee invested. Based on this criteria farmers select the high yielding varieties of maize, sorghum, sunflower and hybrid maize, hybrid cotton that produce more yield than local varieties. Generally farmers are interested to grow the hybrids to get maximum monetary benefits *i.e.*, more income per rupee invested.

3.3 INTENSIVE CROPPING

Definition: Intensive cropping is the process of growing a number of crops on the same piece of land during the given period of time.

Method of intensive cropping - The following methods have been developed to make intensive cropping a success.

3.3.1 Multiple Cropping

Growing two or more crops on the same field in one year. The intensification of cropping is in temporal and spatial dimensions. Double, triple and quadruple cropping refers to growing two, three and four crops respectively, on the same land in a year in sequence.

- (a) **Sequential cropping** - Multiple cropping may be of the following types growing two or more crops in sequence (in succession) on the same field in an year. The succeeding crop is planted after the preceding crop has been harvested. The crop intensification is only in time dimension. *e.g.*, Rice-Rice-Cotton, Ragi-Cotton-Sorghum.
- (b) **Relay cropping** - It refers to planting of the succeeding crop before harvesting the preceding crop. *e.g.*, (i) Rice-Black gram (rice fallow pulse), (ii) Rice-Lathyrus, (iii) Rice-Lucerne, (iv) Rice-Berseem and (v) Cotton-Berseem. Here the seeds of black gram, lathyrus, lucerne or berseem are broadcasted in standing rice or cotton crop just before they are ready for harvesting. Thus the field is never left fallow or there is no gap at all between two successive crops.
- (c) **Ratoon cropping or ratooning** - It refers to raising a crop with regrowth coming out of roots or stalks after harvest of the crop although not necessarily for grain. *e.g.*, Sugarcane, Banana, Sorghum.
- (d) **Overlapping system of cropping** - In this system the crop is harvested in phases and the vacated area is sown by next crop. *e.g.*, forage crops, part of the crop is harvested for feeding to the cattle and vacated area is sown with alternate crops like berseem or lucerne.

3.3.2 Intercropping

Growing two or more crops simultaneously on the same field. The crop intensification is in both temporal and spatial dimensions. There is intercrop competition all or part of crop growth (as opposed to intercropping, sole cropping is growing one crop alone in pure stand at normal density).

A. Principles of Intercropping

- The associating crop should be complimentary to the main crop.
- The subsidiary crop should be of shorter duration and of faster growing habits, to utilize early slow growing period of main crop.
- The component crops should require similar agronomic practices.
- Erect growing crops should be intercropped with cover crop.
- Erosion permitting crop should be intercropped with erosion resisting crop.
- The component crops should have different rooting pattern and depth of rooting.

B. Types of intercropping based on Interactions

1. **Parallel cropping** - Under this two crops are selected which have different growth habits and have a zero competition between each other and both of them express their full yield potential. *e.g.*, black gram with maize, soybean with cotton.
2. **Companion cropping** - Usually a short duration crop is grown along with a long duration crop as a companion crop *i.e.*, the base crop gets the company of another crop for a certain period. *e.g.*, Cotton + black gram/Green gram.
3. **Synergistic cropping** - Here the yield of crops, grown together is found to be higher than the yield of their pure crops on unit area basis. *e.g.*, Sugarcane and potato.

C. Advantages of Intercropping

- It offers similar benefits to that from rotational cropping.
- The total biomass production/unit area/unit time is increased because of the fullest use of land as the inter row spaces are utilized which otherwise would have been used for weed growth.
- The fodder value in terms of quantity and quality becomes higher when a non-legume is intercropped with legume. *e.g.*, Napier + desmanthus, sorghum + cowpea..
- It provides crop yields in different times, which reduces the marketing risks.
- It offers more employment and better utilization of labourers, machine and power throughout the year.
- It is an insurance against drought.

D. Difference between intercropping and mixed cropping

<i>Intercropping</i>	<i>Mixed cropping</i>
1. The main objective of intercropping is to utilize the space between rows of main crop and to produce more grain per unit area	The main objectives of mixed cropping are insurance against crop failure. Purpose is to get at least one crop under any climatic, disease or insect hazards
2. There is no competition between main and subsidiary crops	There is competition between crops. Here all crops area given equal care and there is no main or subsidiary crop
3. In intercropping, the main crop is of long duration and subsidiary crop short duration/early maturing	Generally crops are of the same duration (and may be of different duration also)
4. Main and subsidiary crops are sown in rows with definite row and special arrangement	Mixed cropping, generally crop seed are mixed and broadcasted without any row and spatial arrangement
5. The sowing time of both the crops may be the same or the main crop is sown earlier than the subsidiary crop	The sowing time for all crops is same

E. Types

- (a) **Mixed Intercropping (mixed cropping)** - Growing two or more crops simultaneously with no distinct row arrangement.
- (b) **Row Intercropping (intercropping)** - Growing two or more crops simultaneously where one or more crops are planted in rows.

3.3.3 Multistoried Cropping

Growing crops of different heights in the same field at the same time. It is practiced in orchards and plantation crops for maximum use of solar energy even under normal planting density. *e.g.*, Sugarcane, potato and onion, coconut, pepper, cocoa and pineapple.

3.4 CROP ROTATION

Crop rotation may also be defined as a process of growing different crops in succession on a piece of land in a specific period of time with an object to get maximum profit from minimum investment without impairing the soil fertility.

A. Principles and Advantages

If the same crop is repeatedly grown on the same land it is referred as *monoculture* or *monocropping* (*e.g.*, rice-rice-rice) whereas *crop rotation* is the repetitive cultivation of an orderly succession of different crops and crops and fallow on the same land. One cycle may take several years (one year or more than one year) to complete *e.g.*, rice-rice-pulse (one year), sugarcane-ratoon sugarcane-Rice (2 or 3 years), banana-ratoon banana-rice (3 years).

B. Principles of Crop Rotation

- The crops with tap roots (deep rooted) should be followed by those, which have fibrous (shallow) root system. This helps in proper and uniform use of nutrients from the soil.
- The leguminous crops should be grown before non-leguminous crops because legumes fix atmospheric N into soil and add more organic matter to the soil.
- More exhaustive crops should be followed by less exhaustive crops because crops like potato, sugarcane, maize etc., need more inputs such as better tillage, more fertilizers, greater number of irrigations etc.
- Selection of the crop should be demand based.
- The crop of the same family should not be grown in succession because they act as alternate hosts for insect pests and diseases.
- An ideal crop rotation is one, which provides maximum employment to the farm family and labour and permits efficient use of machines and equipments and ensures timely agricultural operations simultaneously maintaining soil productivity.
- The selection of the crops should be problem based *i.e.*
 - One sloppy lands, which are prone to erosion, an alternate cropping of erosion promoting and erosion resisting crops like legumes should be adopted.
 - In low-lying and flood prone area, the crops, which can tolerate water stagnation, should be selected.
 - Under dry farming the crops, which can tolerate the drought, should be selected.

- The selection of crops should suit farmer's financial conditions.
- The crop selected should also suit the soil and climatic conditions.

C. Advantages of Crop Rotation

- Crop rotation helps in maintaining of soil fertility, organic matter content and recycling of plant nutrients. All crops do not require the plant nutrients in the same proportion. If different crops are grown in rotation, the fertility of land is utilized more evenly and effectively.
- Restorative crops like heavy foliage crops and green manure crops included in rotation increase the nitrogen and organic matter content of the soil.
- Helps in control of specific weeds like bermuda grass, cyprus (sedges) and *Trianthema portulacastrum*.
- Avoids accumulation of toxins and maintains physical properties of soil.
- Controls certain soil borne pests and disease.
- Reduces the pressure of work due to different farm operations in a stipulated period of time.

3.5 CROPPING PATTERNS AND CROPPING SYSTEMS

Cropping pattern is the yearly sequence and spatial arrangement of crops or crops and fallow on a given land area (District, part of a state, a state or part of the country).

Cropping system: Cropping patterns used on a farm and their interactions with farm resources, other farm enterprises and available technology that determine their make up.

Individual crops are the components of a given cropping pattern/system.

A. Factors determining the Cropping System

Prevailing or existing crops and varieties in a cropping system are the cumulative results of past and present decisions of individuals, communities and Government and their agencies. These decisions were based on experimentation, tradition, expectation, profit (economics) personal preferences and resources, political and social pressures and so on. In general, cropping system is developed taking into account:

- availability of resources (input) and managerial skill of farmers suggested for each crop or variety and in crop combination,
- ecologically practicable pest and disease control methods to the existing cropping system and the proposed cropping system,
- interaction of the existing and chosen crop or introduced crops individually or in combination,
- economics of a cropping system prevailed in a region,
- influence of infrastructure facilities including marketing on the ecologically feasible crops of a regional and
- operational factors deciding the existence of economically preferable crops or cropping system in a region.

To describe the cropping pattern of a region the crop occupying the highest percentage of the sown area in a particular season or year of the region is taken as the base crop.

- a substitute for base crop in the same season.

- crop which fit in with the rotation in the subsequent seasons.
- supplementary crops-which are grown in addition to base crop as intercrops.

B. Factors determining the Cropping Pattern

Climate - (a) Atmospheric temperature, (b) Occurrence of rainfall : (i) Quantity of rainfall, and (ii) Period of rainfall.

Topography - Altitude and slope will decide the crops and cropping pattern of a locality.

Soils - (a) Black soil–cotton (b) Red soil–sorghum, red gram, groundnut (c) Laterite and Lateritic soils–rice/tea, (d) Alluvial soils, (e) Sierozemic soils, (f) Chesnut or brown soils.

C. Cropping Patterns

1. Cropping Patterns in India

India may be broadly divided into five agricultural regions.

Rice region: North East, South West and West Coast regions of India.

Wheat region: North, West and Central India.

Millet region (sorghum): Maharashtra, Rajasthan, Gujarat, Madhya Pradesh and Deccan Plateau, Southern peninsula.

Temperate Himalayan region: Kashmir, Himachal Pradesh, Uttar Pradesh.

Plantation crops region: Assam and hills of South India.

(a) Kharif season cropping patterns

1. *Rice based cropping patterns* - On all India basis thirty rice based cropping patterns has been identified in different states. Rice is grown in sequence with cotton, pulses, gingelly, jute, wheat, sugarcane, banana, turmeric, betel vine etc.
2. *Millets based cropping patterns*–
 - (a) *Maize based cropping patterns* - Maize is grown in sequence with sugarcane, groundnut, cowpea, cotton etc. In India twelve cropping patterns were identified with maize.
 - (b) *Sorghum based cropping pattern* - Seventeen patterns were in practice in India.
 - (c) *Pearl millet based cropping patterns* - Twenty cropping patterns were identified.

Both sorghum and pearl millets are grown mostly under identical environmental conditions. Sorghum and pearl millet or growth with red gram, groundnut, etc.

3. *Cotton based cropping patterns* - On All India basis sixteen cropping patterns are identified with cotton. It is grown with groundnut, sorghum, minor millets, rice, sugar cane and tobacco.

(b) Rabi season cropping patterns

Among rabi crops wheat, barley, oats, bengal gram, sorghum are the main base crops. Generally wheat and gram are concentrated in the sub-tropical region in the North India, where as rabi sorghum is grown mostly in deccan.

Wheat and gram based cropping system : On all India basis, nineteen cropping patterns were identified with wheat and seven with gram. Wheat and gram are grown in sequence with maize, rice, sorghum, millets, groundnut, pearl millet, cotton etc.

Rabi sorghum based cropping system : 13 cropping patterns were identified with rabi sorghum which are grown in sequence with pulses, oilseeds, rice, tobacco, groundnut etc.

(For more details refer Annexure IV).

2. Cropping Pattern in Southern India - Tamil Nadu

(a) Wetland cropping patterns

Rice (June-September)	–	Rice (October-February)	–	Rice (February-July)
Rice (July-October)	–	Rice (October-February)	–	Cotton (February-July)
Rice	–	Rice	–	Black gram/Green gram/Gingelly
Rice	–	Rice	–	Groundnut

(b) Irrigated dry cropping patterns

Cotton (August-February)	–	Sorghum (February-March)	–	Ragi (June-August)
Sorghum (August-November)	–	Fodder sorghum (November-January)	–	Cotton (February-July)
Maize (June-September)	–	Sunflower (October- December)	–	Green gram (January-March)

(c) High intensive cropping system for irrigated drylands

It can be achieved by inclusion of an intercrop in each component crop of the cropping pattern.

- sorghum + cowpea (February–May) – onion + ragi (June–August)
- cotton + onion/black gram (August–February)

(d) Rainfed dryland cropping patterns

- sorghum + cowpea/black gram - (South West Monsoon)
- sorghum + red gram (SWM)
- sorghum (SWM) – ratoon sorghum/fodder sorghum (NEM)
- sorghum (SWM) – horsegram/Lablab (NEM)
- groundnut + red gram (SWM)
- finger millet + lablab (SWM)
- cotton + black gram/green gram (SWM)

(e) Multi-tier cropping in rainfed drylands

Three tier cropping of castor, red gram and groundnut and castor-cotton-coriander or black gram mixtures is popular for a number of years.

3.6 CROP PRODUCTION

3.6.1 Factors Affecting Crop Production

The factors are classified under the following types.

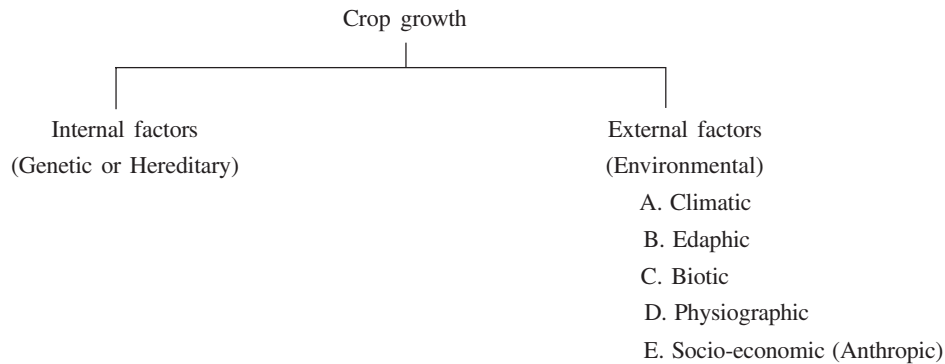

3.6.1.1 Internal Factors

The increased yield and other desirable characters are related to the genetic make up of the plant. The following are the areas to improve the potential of crop plants through genetics and plant breeding techniques.

- High yields under given environmental conditions.
- Early maturity (in some cases late maturity).
- Resistance to lodging.
- Drought, flood and salinity tolerance.
- Tolerance to insects and diseases.
- Chemical composition of grains (high percentage of oil, increase in protein quantity or quality, etc.).
- Quality of grains (fineness, coarseness, etc.).
- Quality of straw (sweetness, juiciness, etc.).

3.6.1.2 Environmental Factors

Life of crop is so intimately related with the environmental factors of a place. Environmental factors do not act in isolation from one another. All these environmental factors as discussed below interact with one another to influence the crop growth and production.

A. Climatic factors

The atmospheric factors, which affect the crop plants, are called climatic factors. They are:

- Precipitation
 - Atmospheric humidity
 - Wind velocity
 - Temperature
 - Solar radiation
 - Atmospheric gases
- (i) **Precipitation** - Precipitation includes all forms of water, which falls from the atmosphere to the earth's surface, in a variety of forms such as rainfall, snow, hail, fog and dew. Fog particles, which contact vegetation, may adhere, coalesce with other droplets and eventually form a drop large enough to fall to the ground. Condensation of the water vapour present in the air in cool nights results in a deposit as dew.

Rainfall is one the most important factors influencing the vegetation of a place. Most of the crops receive their water supply from rainwater. Rainwater is the source of soil moisture so essential for the life of a plant. The yearly precipitation, both in total amount and seasonal distribution greatly affects the choice of cultivated crops of a place. Low and ill-distributed rainfall are common features of dry farming wherein drought resistant crops like sorghum, pearl millet, Italian millet and other minor millets are commonly grown. On the other hand in places of heavy and regular rainfall areas such as in the Western Ghats of India crops like rice are grown in flat areas while tea, coffee, rubber etc., are grown in the slopes. The interaction of rainfall with temperature has a very profound effect on the vegetation and soil of a place. Very heavy rainfall and high temperature in the equatorial and tropical zones cause the formation of most highly developed vegetation of the world.

Relationship between Climate, Natural Vegetation and Soil

<i>Dry cold</i>			<i>Wet cold</i>
Perpetual snow and ice	–	–	Perpetual snow and ice
Tundra	–	–	Tundra soils
Taiga	–	–	Podzol soils
Arid	Semi arid	Subhumid	Humid rain forests
Desert grasses and shrubs	Steppe	Grassland	
Sierozems and desert soils	Chestnut and brown soils	Prairie soils and chernozems	Podzol, grey brown/red podzol soils laterite soil
Dry hot			Wet hot

It may thus be seen that while desert grasses and shrubs are found in desert soils of dry hot climate, rain forests are seen in laterite soils of wet hot climate.

- (ii) **Temperature** - Temperature is a measure of intensity of heat energy. The range of temperature for maximum growth of most of the agricultural plans is between 15 and 40°C. The temperature of a place is largely determined by its distance from the equator (latitude) and the altitude. Based on the above, the vegetations are classified as tropical, temperate, taiga, tundra and polar. Some investigators have classified the vegetative of the world into four classes on the basis of prevailing temperature conditions as shown in the following Table 3.1.

Table 3.1. Classification of Vegetation based on Temperature

<i>Class</i>	<i>Region</i>	<i>Temperature conditions</i>	<i>Type of vegetation</i>	<i>Common crops cultivated</i>
Megatherms	Equatorial and tropical	High temperature throughout the year	Tropical rain	Tropical crops like cassava, varieties of rubber, rice, etc.
Mesotherms	Tropical and sub tropical	High temperature alternating with low temperature of winter	Tropical deciduous forests	Sub-tropical crops like maize, sorghum etc.

(Contd.)

<i>Class</i>	<i>Region</i>	<i>Temperature conditions</i>	<i>Type of vegetation</i>	<i>Common crops cultivated</i>
Microtherms	Temperate and altitude plants (upto 12,000 ft of tropical and sub-tropical)	Low temperature	Mixed coniferous forests	Temperate crops like wheat, oats, potato
Hekistotherms	Arctic and Alpine regions (above 16,000 ft in tropics and 12,000 ft in temperature regions)	Very low temperature	Alpine vegetation	Pines, Spruce, etc.

Every plant community has its own minimum, optimum and maximum temperature known as their **cardinal points** (Table 3.2). Apart from the reduction in yield many injuries on the plants and adverse effect on soil conditions occur under both extremes on temperature.

Table 3.2. Cardinal Temperature of certain Crops for Germination

<i>Crops</i>	<i>Minimum °C</i>	<i>Optimum °C</i>	<i>Maximum °C</i>
Wheat	4.5	20	30–32
Barley	4.5	20	29–30
Oats	4.5	20	29–30
Maize	8–10	20	40–43
Sorghum	12–13	25	40
Rice	10–12	32	36–38
Tobacco	12–14	29	35

B. Daily cycle of temperature (Diurnal Variation)

From sun rise until 2-4 pm, when the energy is being supplied by incoming solar radiation is faster than it is being lost by earth by re-radiation, the air temperature rises. From about 2-4 pm when the loss of radiation by earth exceeds receipt of solar energy the temperature falls. It is noticeable that the time of highest temperature (2-4 pm) does not, however, exactly coincide with that of noon solar radiation. This lag occurs because temperature continued to rise as long as the amount of incoming solar radiation exceeds the outgoing earth's radiation. Although the energy receipts being to decline in the afternoon they continue to exceed the energy losses until about 3 pm. The energy gained during the day is slowly lost to the atmosphere by re-radiation, resulting in the reduction of temperature. Hence, minimum temperature is reached between 2 to 6 am. Diurnal = pertaining to action that are completed within 24 hours and that recur every 24 hours. This variation is known as diurnal variation. The temperature distribution varies with latitude, altitude and the seasons. It varies diurnally at a given location because of the rotation of the earth.

C. Vertical distribution (altitude)

As a general rule throughout the troposphere, the temperature decreases with elevation. The rate of decrease with altitude is not uniform; it varies with time of the day, season and location. The average decrease is approximately 0.65°C/100 m. (6.5° C/km). This is known as **normal lapse rate or vertical temperature gradient**.

D. Temperature inversion

Although normally, the lower several miles of atmosphere show a decrease in temperature with increasing altitude, this condition is reversed at certain levels so that temperature temporarily increases with altitude when the colder air lies below warmer air and closer to earth's surface the normal lapse rate is reversed and this is called temperature inversion.

E. Horizontal distribution (Latitude)

The lines connecting places, which have same air temperature, are called **isotherms**. Thus, all the points on a map through which any one isotherm passes have identical average temperature for the period indicated. There is general decrease from equator to poles (increase in latitude).

- Irregular distribution of land and water on earth's surface breaks the latitudinal variation in temperature.
- Land areas warm and cool rapidly than water bodies.
- Mountain barriers influence horizontal distribution of temperature by restricting movement of air masses.
- On local scale topographic relief exerts an influence on temperature distribution.

F. Seasonal variations

Temperature (diurnal, mean and range) varies according to the season. The main factors contributing to seasonal variations are:

- The angle of inclination of solar rays, which decides the intensity of radiation.
- Distance between earth and sun.
- The movement of seasonal winds which contributes to rain and precipitation.

G. Effect of temperature

Air temperature is the most important weather parameter, which affects the plant life. The growth of higher plants is restricted to a temperature between 0–60°C and the optimum 10°C–40°C. Beyond these limits, plants are damaged severely and even get killed. The maximum production of dry matter occurs when the temperature ranges from 20 to 30°C. Apart from yield reductions, many visible injuries on the plants are seen due to very low or very high temperature.

I. Low temperature effects

(a) **Cold injury** - Plants are injured due to very low temperature in the following ways:

Chilling injury - Plants growing in hot climate, if exposed to low temperature (which is above the freezing point) for some time, are found to be killed or injured severely. *e.g.*, Chlorotic condition or bands on leaves of sugarcane, sorghum and maize when exposed for 60 hours at 2–4°C.

Freezing injury - This is generally caused in plants growing in temperate region. When the plants are exposed to very low temperature, water is frozen into ice crystals in the intercellular spaces. With further fall in temperature, water is withdrawn from the cells, resulting in increase in the size of ice crystals in the intercellular spaces. The protoplasm of the cell is dehydrated, and mechanical distortion takes place resulting in killing of the cells. Frost damage to potatoes, tea etc., in winter in the hilly areas like the Nilgiris is a typical *e.g.*, of the freezing injury.

Suffocation - During winter the ice or the snow form a thick cover over the ground and the crop suffers for want of oxygen. Ice in contact with roots inhibits diffusion of carbon dioxide and the respiratory products may become harmful to plants.

Heaving - Injury to plants is caused by a lifting upward of the plant along with the soil from its normal position in temperate regions where snowfall is common.

II. High temperature effects

Cells of most plant species get killed when the temperature ranges from 50 to 60°C. This point of temperature is called **thermal death point**. But it varies with the species, the age of tissue and the time of exposure to high temperature. It is reported that most plant cells are killed at a temperature of 45 to 55°C. Some plants tissues withstand a temperature of up to 105°C. The aquatic plants and shade loving plants are killed at comparatively, lower temperature (40°C); where as, for xerophytes it is 50°C. High temperature results in desiccation of the plants and disturbs the balance between photosynthesis and respiration. Higher temperature increases the respiration leading to rapid depletion of reserve food in plants resulting in growth stunted due to incipient or starvation.

Heat injury - Very high temperature often stops growth. The plant faces incipient starvation due to high respiration rates. The plant is stunted and if such a condition persists for a long period the plant is killed. Direct temperature effects are noticeable in young seedlings and transplanted crops. High temperature causes sterility in flowers. The general effects of excessive heat are defoliation, premature dropping of fruits and in extreme cases death of plants.

- (i) **Sun clad:** Injury caused by high temperature on the sides of bark is known as sun clad. This is nothing but exposure of barks of the stems to high temperature during daytime and low temperature during nighttime.
- (ii) **Stem girdle:** It is another injury associated with high temperature. High temperature at the soil surface scorches the stems at ground level. This type of injury is very common in young seedlings of cotton in sandy soil where the after noon soil temperature exceeds 60°C to 65°C. The stem girdle injury is first noticed through a discoloured band a new millimeter wide. This is followed by shrinkage of the tissues, which have been discoloured. The stem girdle causes the death of the plant by destroying the conductive and cambial tissues or by the establishment of pathogens in the injury. As direct effects on crop plants high temperature causes sterility in flowers. The general effects of excessive heat are defoliation, pre-mature dropping of fruits. In extreme cases, death of the plants may also occurs.

A. Effects of Temperature on Crop Production

Plants can grow only within certain limits of temperature. For each species and variety there are not only optimal temperature limits, but also optimal temperatures for different growth stages and functions, as well as lower and upper lethal limits. During photosynthesis there are certain biochemical processes preceding and following the reduction of carbon dioxide, which are affected mainly by temperature. As long as light is limiting, temperature has little effect on the rate of photosynthesis. When light is not limiting, it has a profound effect on the rate of photosynthesis. In general, high temperature accelerates growth process. Rarely are high temperatures *per se* the direct cause of death of plants, provided the water supply is adequate. Retardation of growth and difficulties in fertilization are observed even in heat loving crops such as sorghum, at extremes of temperatures. The harmful effects of excessive temperatures are usually aggravated by lack of available moisture. Hot dry winds will further increase the damage. Increasing temperatures increases evapotranspiration. The daily alternations of high and low temperature may effect grain production.

B. Factors Affecting Air Temperature

Latitude - The time of occurrence of maximum monthly mean temperature and minimum monthly

mean temperature also depends on latitude of a place. (*e.g.*) The coldest month is January in northern regions of India while December in the south. Similarly, the warmest month is May in the south while June in the north across the country.

Altitude - The surface air temperature decreases with increasing altitude from the mean sea level as the density of air decreases. Since the density of air is less at higher altitudes, the absorbing capacity of air is relatively less with reference to earth's long wave radiation.

Distribution of land and water - Land and water surfaces react differently to the insolation. Because of the great contrasts between land and water surfaces their capacity for heating the atmosphere varies. Variations in air temperature are much greater over the land than over the water. The differential heating process between land and sea surfaces are due to their properties. It is one of the reasons for Indian monsoon.

Ocean currents - The energy received over the ocean surface carried away by the ocean currents from the warm areas to cool areas. This results in temperature contrast between the equator and poles. The occurrence of El Nino is due to change in sea surface temperature between two oceanic regions over the globe.

Prevailing winds - Winds can moderate the surface temperature of the continents and oceans. In the absence of winds, we feel warm in hot climates. At the same time, the weather is pleasant if wind blows.

Cloudiness - The amount of cloudiness affects the temperature of the earth's surface and the atmosphere. A thick cloud reduces the amount of insolation received at a particular place and thus the daytime temperature is low. At the same time, the lower layers in the atmosphere absorb earth's radiation. This results in increasing atmospheric temperature during night. That is why, cloudy nights are warmer. This is common in the humid tropical climates.

Mountain barriers - Air at the top of the mountain makes little contact with the ground and is therefore cold while in the valley at the foothills makes a great deal of contact and is therefore warm. That is, the lower region of the earth's atmosphere is relatively warmer when compared to hillocks.

III. Atmospheric humidity

Water is always present in the atmosphere in the form of invisible water vapour, normally known as humidity of the air. When the atmosphere contains the maximum possible amount of water vapour it is said to be saturated at the particular temperature and pressure. Any increase in temperature, water remaining constant, will make the air unsaturated. In unsaturated condition, the water vapour content of air is usually expressed as *relative humidity*, which is the ratio between the actual humidity present and the saturation humidity possible at that temperature. The relative humidity of a place, is being affected by temperature and pressure. It is also affected by wind, exposure to radiation, vegetation and water content of the soil. The evaporation of water from plants or a body of water is directly dependent on the relative humidity of the atmosphere.

Humidity: The terminology related to humidity and concerned with gaseous form of water *i.e.*, water vapour, several expression of the amount of water vapour in the air is used.

Absolute humidity: It denotes the actual mass of water vapour in given volume of air. It may be expressed as the number of grams of water vapour in a cubic meter of moist air or mass of water vapour per unit volume of air.

Specific humidity: It is defined as the moisture content of moist air as determined by the ratio of the mass of water vapour to the mass of moist air in which the mass of water vapour is contained.

Relative humidity: Relative humidity is a common parameter for expressing water vapour content

of the air. It is the percentage of water vapour present in the air in comparison with saturated condition at a given temperature and pressure. The R.H. can be expressed as

$$RH = \frac{100r}{rw}$$

Where “*r*” is the mixing ration of moist air at pressure (*p*) and temperature and “*rw*” is the saturation-mixing ratio at same temperature and pressure.

Mixing ratio: The mass of water vapour per unit mass of dry air is a convenient parameter to express the relative composition of the mixture. It is defined as the ratio of the mass of water vapour to the mass of dry air with which the water vapour is associated.

Dew point: The temperature at which saturation occurs in a given mass of air. The dew point temperature is often compared with the temperature of free air and also used to predict the occurrence of fog, dew, frost or precipitation.

Vapour pressure: This is the amount of partial pressure created by water vapour in the air expressed in the units of millibar (or) inches of mercury.

Evapotranspiration of crop plants increases with temperature but decreases with high relative humidity affecting the quantity of irrigation water. Moist air favours the growth of many fungi and bacteria and these affect seriously the crop. The blight diseases of potato and tea are common examples of diseases spread under moist weather. Similarly many kinds of insect parasites such as aphids and jassids thrive well moist conditions.

RH on Plant growth

Increase in RH - decreases the temperature. This phenomenon increases heat load of the leaves. Since transpiration is reduced - not much heat energy used. Excessive heat due to closure of stomata entry of CO₂ is reduced. Reduction in transpiration reduces the rate of food translocation and uptake of nutrients.

Very high RH is beneficial to	–	Maize, Sorghum, Sugarcane (C ₄ Plants)
Harmful to	–	Sunflower, Tobacco.

For almost all the crops it is always safe to have a moderate R.H. of above 40%. 60–80% conducive for growth and development of plants. The humidity is not an independent factor. It is closely related to rainfall, wind and temperature. It plays a significant role in crop production.

- The humidity determines the crops grown in a given region.
- It affects the internal water potential of plants.
- It influences certain physiological phenomena in crop plants including transpiration
- The humidity is a major determinant of potential evapotranspiration. So, it determines the water requirement of crops.
- High humidity reduces irrigation water requirement of crops as the evapotranspiration losses from crops depends on atmospheric humidity.
- High humidity can prolong the survival of crops under moisture stress. However, very high or very low relative humidity is not conducive to higher yields of crops.
- There are harmful effects of high humidity. It enhances the growth of some saprophytic and parasitic fungi, bacteria and pests, the growth of which causes extensive damage to crop plants. *e.g.*, (a) Blight disease on potato. (b) The damage caused by thrips and jassids on several crops.
- High humidity at grain filling reduces the crop yields.

- A very high relative humidity is beneficial to maize, sorghum, sugarcane etc, while it is harmful to crops like sunflower and tobacco.
- For almost all the crops, it is always safe to have a moderate relative humidity of above 40%.

IV. Solar radiation

The sun is the primary source of heat to the earth and its atmosphere. The heat received from other celestial bodies as well as the interior of the earth is rather too insignificant to merit our attention. The distance that separates the earth from the sun is about 1,49,000,000 km. The diameter of the sun measures roughly about 13,82,400 km. The surface temperature of the sun is estimated between 5500°C and 6100°C (or 5762°K). Solar radiation provides more than 99.9% of the energy that heats the earth. Undoubtedly, the radiant energy from the sun is the most important control of our weather and climate. The most astonishing fact about the incoming solar radiation (insolation) that strikes the earth's surface is that it is equal to about 23 billion horsepower. Actually it is this amount of energy received from the sun that acts as the driving force for all the atmospheric as well as biological processes on the earth. Besides, all other sources of energy found on earth such as coal, oil and wood etc., are nothing but converted form of solar energy. The word 'insolation' is contraction of "incoming solar radiation". Radiant energy from the sun that strikes the earth is called insolation.

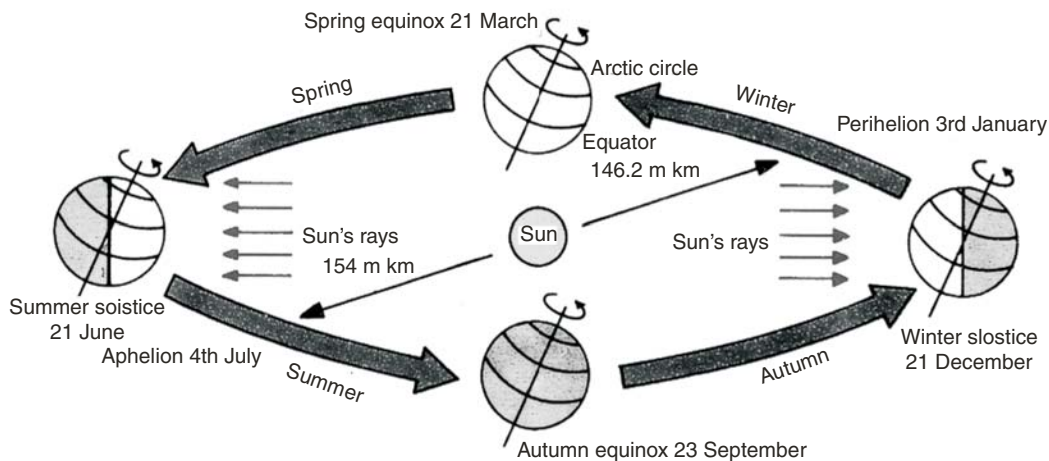

Fig. 3.1

Solar energy provides two essential needs of plants (a) **light**, required for photosynthesis and for many other functions of the plant-including seed germination, leaf expansion, growth of stem and shoot, flowering, fruiting and even dormancy, and (b) **thermal conditions** required for the normal physiological functions of the plant.

Solar radiation consists of a bundle of rays of radiant energy of different wavelengths. The sun emits radiant energy in the form of electromagnetic waves. The visible portion of the solar spectrum appears as light. Light travels with a speed of 2,97,600 km/sec. It takes 8 minutes and 20 seconds to reach the earth. Light is the total effect of the combination of the seven different colours, namely red, orange, yellow, green, blue, indigo and violet. (VIBGYOR). The waves that produce the effect of red colour are the longest and those producing the violet are the shortest. Waves shorter than the violet are called ultraviolet rays, while those longer than the red are known as infrared rays. The ultra violet waves form only 6% of the insolation, but have strong photochemical effects on some substances. The infrared rays, even though invisible, form 43% of the insolation. They are largely absorbed by water vapour that is concentrated in the lower atmosphere.

Solar constant is defined as the rate at which solar radiation is received outside the earth's atmosphere on a surface perpendicular to the sun's rays when the earth is at an average distance from the sun. The Smithsonian Institute, USA has come to the conclusion that the standard value of solar constant is 1.94 gram calories per cm²/minute. Since there is fluctuation in the amount of radiant energy emitted by the sun due to periodic disturbances on the solar surface, the amount of solar constant, therefore, registers a slight increase or decrease. However, this variation hardly exceeds 2-3%.

Light is one of the most important climatic factors for many vital processes of the plant. It is indispensable for the synthesis of the most important pigment of the plant, *i.e.*, the green chlorophyll. The chlorophyll is capable of absorbing radiant energy and converting it into potential chemical energy of carbohydrates. The carbohydrates manufactured by the plants during photosynthesis are the only link between the solar energy and the living world. It regulates the rate of transpiration by controlling the opening and closing of stomata. Light affects the plants through its intensity, quality (wave length), duration (photoperiod) and direction.

1. **Light intensity** - The variations in light intensity are always accompanied with change in temperature and relative humidity and therefore it is difficult to evaluate light effects alone. Generally speaking light intensity falling at a particular place is normally enough for the plants and their physiological phenomena *viz.*, photosynthesis.

In photosynthesis about one percent of the light energy is converted into potential chemical energy. Very low light intensity reduces the rate of photosynthesis and may even result in the closing of the stomata. This results in reduced vegetative growth of the plants. Very high light intensities are detrimental to plants in many ways. It increases the rate of respiration and thus disturbs the photosynthesis-respiration balance. It causes rapid loss of water resulting in the closure of stomata. The most harmful effect of high light intensity is the phenomenon of "Solarization" in which all the cell contents are oxidized by atmospheric oxygen. This oxidation is different from respiration and is termed as **photo oxidation**.

Based on the response to light intensities, the plants are classified as follows:

- (i) *Sciophytes* (Shade loving plants) - The plants that grow better under partially shaded (low light) conditions *e.g.*, betel vines, buckwheat, turmeric etc.
- (ii) *Heliophytes* (Sun loving plants) - Many species of plants produce maximum dry matter under high light intensities when the moisture is available at the optimum level, *e.g.*, maize, sorghum, rice etc. Except under glass house or shaded conditions, intensity of light cannot be controlled.

Depending upon the nature of the crops, the dry matter production is affected. Many species produce maximum dry matter under high light intensity if water is available in plenty. However crops like betelvine, turmeric, buckwheat, and tobacco grown during summer produce greater dry matter if slightly shaded.

2. **Quality of light** - When white light is passed through a prism it is dispersed into wavelengths of different colors; violet 400-435 mill microns (m μ); blue 435-490; green 490-574; yellow 574-595; orange 595-626 and red 626 to 750 m μ . Visible rays 390-760 micron μ , nm

$$\begin{aligned} \text{Micron} &= \frac{1}{1000000} = 10^{-6} \text{ meter} \\ &= \frac{1}{1000} = 10^{-3} \text{ mm} \end{aligned}$$

Milli micron : 10^{-9} m = nanometer

The principle wavelength absorbed in photosynthesis is in the violet-blue and the orange red regions. Among these short rays beyond the violet such as Ultra Violet rays, X rays and Gamma rays and longer rays beyond red such as infrared are detrimental to growth. Red light seems to be the most favourable light for growth followed by violet-blue. Ultraviolet and shorter wavelengths of the visible light are scattered and infrared and longer wavelengths are absorbed by moisture of the atmosphere. Such a light is called diffused light or skylight. Ultraviolet and shorter wavelengths kill bacteria and many fungi.

3. **Duration of light** - It is important from the farmer's point of view in selecting the variety of a crop. The length of the day has greater influence than the intensity. The response of plants to the relative length of day and night is known as '**photo periodism**'. Plants which develop and produce normally when the photoperiod is greater than a critical minimum (more than 12 hours of illumination) are called '*long day plants*' (sugar beet, wheat, barley) and those develop normally when the photoperiod is less than a critical maximum (less than 12 hours of illumination) are called '*short day plants*' (soybeans, maize and millets). Some plants are found to be unaffected by photoperiod and are called as '*day-neutral*' plants (Tomato, asparagus etc.) Plant characters like floral development, floral initiation, bulb formation, rhizome production etc. are all influenced by photo-periodism. If a long day plant is subjected to short day periods the internodes may be shortened to give a rosette appearance and flowering will not take place. In the same way when a short day plant is subjected to long day period, the growth of the plant becomes abnormal and there is no floral initiation (For *e.g.*, CO 36 rice variety).
4. **Direction of light** - Shoots, roots and leaves show different orientation to the direction of light. In temperate regions, the southern slopes show better growth of crops than the northern slopes due to the direction of light contributing more sunlight towards the southern side.
 - (i) *Orientation of leaves* - The change of position or orientation of organs of plants caused by light is usually called as "Phototropism". For *e.g.*, the leaves are oriented at right angles to incidence of light to receive maximum radiation.
 - (ii) *Photomorphogenesis* - Change in the morphology of plants due to light. This is mainly due to ultra violet and violet rays of the sun.

Instruments used for measuring solar radiation - Bellanis pyranometer, Sunshine recorder, Line quantum sensor, Photometer, Lux meter measures the light intensity and Radiometer.

V. Wind velocity and its effect on crop production

Air in horizontal motion is known as wind. Vertical movement is noticed but negligibly small compared to horizontal movement as the height of the atmosphere is only for few km. However vertical movement or uplift of air only causes significant weather changes in cloud formation and rain. The velocity of wind at a place depends on various factors such as geographical situation, topography, altitude, distance from seashore, flat plains, vegetation etc. Wind affects crop growth mechanically (directly) and physiologically (indirect).

Wind speed in different seasons

Winds represent air in motion. The primary cause of all winds is regional differences in temperature, producing regional differences in pressure. When these pressure differences persist for several hours, the rotation of the earth modifies the direction of motion, till the winds blow along lines of equal

pressure. Wind direction and speed are modified frequently due to seasonal variation in solar radiation and differential heating of the earth's surface.

1. **Wind speed:** The winds are generally measured over level, open terrain at 3 metres about ground. Yet, a general idea of the distribution of the mean daily wind speed, on an annual basis as well as on a monthly basis, would be useful. The mean daily wind speed is the value obtained by averaging the wind speed (irrespective of direction) for a whole day. This averaged for all the days of a month is the mean daily wind speed for that month. The daily values averaged for all the 365 days of the year is the annual mean daily wind speed.
2. **Wind Direction:** Winds are always named after the direction they come from. Thus, a wind from the south, blowing towards north is called south wind. The wind vane is an instrument used to find out the direction of the wind. Windward refers to the direction wind comes from, and leeward refers to the direction it blows to. When a wind blows more frequently from one direction than from any other, it is called a prevailing wind.
3. **South West Monsoon wind direction:** During South West Monsoon period of June to September, the westerly winds prevail on the west of Kerala and south winds on the west of northern Circars, Orissa and Bengal. During April and May the region of high temperature is shifted to north *viz.*, upper Sind, lower Punjab and Western Rajasthan. This area becomes the minimum barometric pressure area to which monsoon winds are directed.
4. **North East Monsoon wind direction:** During North East Monsoon period of October to December, on account of the increase in barometric pressure in Northern India, there is a shift in the barometric pressure to the South East and North Easterly winds begin to flow on the eastern coast, by the end of September. These changes bring on heavy and continue rainfall to the Southern and South Eastern India.

(a) *Mechanical effects*

- Wind causes mechanical lacerations and bruises on the tissues of crop plants,
- Violent winds causes lodging of crop plants such as wheat, maize, sugarcane, rice etc.,
- A very high velocity of wind (gale, blizzard, hurricane, cyclone etc., breaks dead and living branches of trees and even uproots them completely,
- In bare deserts, high velocity of wind causes constant soil erosion and this makes it difficult for plants to grow,
- Wind has a powerful effect on the humidity of atmosphere.

(b) *Physiological effects*

- Wind increases the rate of transpiration in plants.
- Hot dry winds causes much damage to crops at the time of flowering.
- The internal water balance of plants is affected resulting in poor seed setting.
- Another form of damage in *blossom injury* caused by evaporation of secretions from the stigmas.

(c) *Beneficial effects*

- Wind is also responsible for causing rainfall to a very large extent. In India the monsoon type of rainfall is largely determined by particular patterns of wind movement. (Trade winds)
- Wind helps in pollination of flowers and dispersal of seed, fruits and microorganisms.
- The hot, dry wind may reduce the incidence of dangerous yellow rust of wheat.
- Moderate wind has a beneficial effect on photosynthesis by continuously replacing the carbon dioxide absorbed by the leaf surfaces.

(d) Remedy

Velocity of wind can be reduced by growing tall, sturdy trees across the direction of the wind as *wind breaks*.

To arrest the movement of soil by wind erosion *shelterbelts* of vegetation are raised.

VI. Atmospheric gases

The atmosphere surrounding the earth contains a mixture of gases *viz.*, carbon dioxide (0.03%), oxygen (20.95%), nitrogen (78.09%), argon (0.93) and miscellaneous gases (0.02%) in a constant proportion.

- (a) **Carbon dioxide** - The CO₂ is the main source of carbon for the various types of organic compounds in the body of the plants. It is the main raw material for the manufacture of carbohydrates by the photosynthetic process of the green plants. Photosynthesis is approximately proportional to the concentration of CO₂ in the air surrounding the foliage of the crop. The CO₂, which gets incorporated into the organic compounds of the plants, returns to the atmosphere by respiratory break down of these compounds and by the death, decay and combustion of plants (carbon cycle). Increased growth and greater yield of vegetables are possible under green house conditions by increasing the content. Aquatic plants utilize the dissolved CO₂, from water.
- (b) **Oxygen** - Life sustains because of oxygen. The amount of O₂, is normally constant in the air because plants give off O₂, during photosynthesis.
- (c) **Nitrogen** - Lightning, rainfall and nitrogen fixing microorganism contributes nitrogen to the soil from the atmosphere. Symbiotic bacteria like rhizobium, free-living bacteria like azotobacter, blue green algae etc., fix a good amount of nitrogen in the soil. The decomposition of dead plants and animals also adds N to the soil. The N in the soil is made available to the crops by the activity of nitrifying bacteria. Certain gases like SO₂, CO and HF when released into the air in sufficient quantities are toxic to plants.

A. Edaphic factors

Plants grown in a land are completely dependent on the soil in which they grow for anchorage, water and mineral nutrients. The soil factors, which affect the crop growth, are:

1. Soil moisture; 2. Soil air; 3. Soil temperature; 4. Soil mineral matter; 5. Soil organic matter;
6. Soil organisms, and 7. Soil reaction.

Table 3.3. Composition of Soil

<i>Composition</i>	<i>Percent</i>
Mineral matter	30
Soil moisture	30
Soil air	30
Soil organic matter	5–10

Soil moisture - In plant tissues water constitute about 90%. The moisture lost through transpiration is made up only by absorbing water from the soil. The moisture is held within the soil by the attractive forces of the soil particles. The capillary moisture held in the pF range of 2.54–4.2 is available for plants. It is the available soil moisture range between saturation point and wilting point. The moisture with about pF 2.54 is very favourable for plant growth. The moisture near pF 4.2 (wilting point) is

absorbed by plants only with great difficulty and the plants may not be able to make vigorous growth near this moisture level. pF : is the logarithm of height (in cm) of a water column that represents total stress with which water is held by the soil.

Soil air - Aeration of the soil is absolutely essential for the absorption of water by roots. O_2 is required for respiration of roots and microorganisms. In poorly aerated soil the CO_2 get accumulated and is detrimental, for absorption of water by the roots. Soil air is also useful in increasing the nutrient availability of the soil by,

- breaking down the insoluble mineral into soluble salts;
- decomposing organic matter, and
- bringing out nitrifying (nitrogen releasing) and nitrogen fixing processes of bacteria.

Soil temperature - It affects the physical and chemical processes going on in the soil. It influences the rate of absorption of water and solutes, the germination of seeds and the rate of growth of the underground portions of the plant body.

The maximum absorption of water by the roots takes place generally between $20^\circ C$ and $30^\circ C$. Temperature below $20^\circ C$ causes appreciable reduction in the rate of absorption of water. Cold soils are therefore not conducive for rapid growth of most agricultural crops. Soil temperature controls micro-biological activity and processes involved in the availability of nutrients to plants. Nitrification begins in the soil when the temperature reaches about $5^\circ C$.

Soil mineral matter - The mineral content of the soil is derived from the weathering of the rocks and minerals as particles of different sizes. These are sources of plant nutrients such as Si, Ca, Mg, Fe, K, Na and Al. Minor elements (trace elements) like B, Mo, Zn, Cu, Co, Iodine and Fe are also present in very small quantities.

Soil organic matter - The soil organic matter content varies from less than 1% in arid sandy soils to as much as 90% of dry weight of well developed soil. It has a marked influence on the soil properties and growth of crops. The organic matter of the soil is derived from (i) dead and decaying roots of plants and living organisms present in the soil, and (ii) dry leaves, twigs, dead plants and animals added to the soils.

Advantages of soil organic matter

- It is the source of essential plant nutrients for crop growth. It contains 95% of total N, 50–60% of total P and 10–20% of the total S;
- It increases water holding capacity of the soil due to its organic colloids;
- It increase the cation exchange capacity (CEC) of the soil; and
- It is a source of food for most of the soil organisms.

Soil organisms - Raw organic matter in the soil is not directly used by the plants as food. It must be broken down first into humus and then into simpler products before it can be utilized. This work is done by different kinds of organisms as given below, which inhabit the soil in billions.

Flora -	Macro flora -	Roots of higher plants
	Micro flora -	Bacteria, Actinomycetes, Fungi, Algae
Fauna -	Macro fauna -	Earthworms, Burrowing vertebrates (moles, gophers, rats, etc.)
	Micro fauna -	Protozoa, Nematodes, Mites, Insects

Soil reaction - Soils may be neutral, acidic or alkaline depending upon their content of basic salts and acidic components. Neutral soils are the best for growth of most crops. Soil acidity beyond a particular limit (**soil with low pH**) is injurious to the plant growth due to:

- Aluminium toxicity under high acidity.
- Interferes with the absorption of several nutrients particularly cation like K, Ca and Mg.

Effects of high soil pH

- P gets fixed in acidic soils.
- Organic matter decomposition is reduced.
- Activities of nitrifying and nitrogen fixing bacteria may be checked.
- Favours fungal diseases like potato scab.

Similarly high alkalinity of the soil (soil with high pH) also adversely affects crop growth. Presence of high amount of sodium interferes with nutrient and water absorption. Soil aeration and infiltration are also reduced due to poor physical condition.

B. Biotic factors

Beneficial or harmful effects caused by other plants and animals on the crop plants are the effect of biotic factors.

Plants

- (a) **Competitive and complimentary nature among field crops** - Competition between plants occurs when there is demand for nutrients, moisture and sunlight, particularly when they are in short supply or the plants are closely spaced. Optimum spacing of crops is an important agronomical practice. When different crops such as cereals and legumes are grown together as in mixed cropping there is mutual benefit resulting in better yield.
- (b) **Competition between weed and crop** - Weeds reduce crop yields due to competition with crops for water, soil nutrients and light. In dry farming condition weeds compete with crops for water. In irrigated tracts, the competition is severe for nutrients. Weeds in fallow land deplete the soil of both moisture and nutrients.
- (c) **Plants as Parasites** - A plant parasite is dependent on its host plant for its existence. Parasitic plants like striga, orabanche, cuscuta and loranthus live on the host plants and affects growth of the crop plants. Parasitic fungi, bacteria, virus etc., causes different kinds of diseases on agricultural crops.
- (d) **Symbiosis** - Different organisms have mutual relationship with each other and with the environment. This biological inter relationship among the organisms is termed as symbiosis. *e.g.*, Legumes and rhizobia–nodule forming; Azotobacter–free living (it fixes elemental N present in the atmosphere and supplies to the plants).

Animals

- (a) **Soil animals or Soil fauna** include protozoa, nematode, rotifers, snails and insects. They help organic matter decomposition while using the organic matter for their living.
- (i) **Harmful organisms** - Insects and nematodes cause considerable damage as crop pests during the growth of plants and in storage of grains. The average loss due to insects is about 20% throughout the world.

(ii) **Beneficial organisms** - Many plants are pollinated primarily by insects. The examples of beneficial organisms are:

1. Bees and wasps are important for pollination.
2. Moths, butterfly and beetles also do pollination. Beetle (*Elaeis kaemeniricus*) is necessary to have good pollination in oil palm crop.
3. Burrowing of earthworm facilitate aeration and drainage of the soil, Ingestion of organic matter and mineral matter results in a constant mixing of these materials in the soil there by favours better growth of plants.

(b) **Small animals** - Small animals like rabbits, squirrels and field rats also cause excessive damage to field and garden crops.

(c) **Large animals** - Large animals like domestic animals and wild animals cause damage to crop plants by grazing and browsing habits.

C. Physiographic factors

It can be studied under two categories such as:

- (1) **Geological Strata** - It accounts not only for the kind of parent material utilized in soil formation but also on the nature of crops grown in these soils for proper utilization.
- (2) **Topography** - The nature of the surface of earth is known as topography. Topographic factors affect the crops indirectly by modifying climatic and edaphic factors of a place. It includes:
 1. *Altitude of the place*: Increase in altitude causes decrease in temperature and increase in precipitation and wind velocity.
 2. *Steepness of slope*: It causes swift run off of rainwater resulting decreased moisture content of soil. The organic matter of the soil increases resulting in high N content and acidity of the soil.
 3. *Exposure of the slope to light and wind*: A mountain slope exposed to weak intensity of light and strong dry winds as the case of northern slopes of temperate regions and the Himalayas may have poor crops due to want of moisture and sunlight. Similarly the western slopes of Tamil Nadu hills poor crops due to damage caused by heavy winds.
 4. *Direction of the mountain chains*: It governs the distribution of the rainfall during monsoon and also the type of crops in dry farming.

D. Anthropic (socio economic) factors

- Man/women produce changes in plant environment and are responsible for scientific crop and soil management,
- breeding varieties for increased yield, and
- introduction of exotic plants

These factors affect the management of soil and crop, which leads to higher production. In addition to the above the socio economic factors affecting the crop production are: (i) the economic conditions of the farmer greatly decides the input/resource mobilizing capacity, (ii) the educational status and technical know-how of the farmer, (iii) the resource allocation ability and social values of the farmer, (iv) government price policy, and (v) marketing and storage facilities etc.

Agricultural Meteorology

Meteorology is derived from a Greek word “*Meteoro*” means ‘above the earth’s surface’ (atmosphere) and “*logy*” means “*indicating science*”. It is a branch of physics dealing with atmosphere and it is often quoted as the “Physics of the lower atmosphere”. It studies the individual phenomenon of the atmosphere. In other words, it is concerned with the study of the characteristics and behaviour of the atmospheres. It explains and analyses the changes of individual weather elements such as air pressure, temperature and humidity that are brought about due to the effect of insolation (radiation from the sun received by earth’s surface).

Agricultural meteorology is a branch of applied meteorology, which investigates the physical conditions of the environment of growing plants or animal organisms. It is an applied science, which deals with the relationship between weather/climatic conditions and agricultural production or it is a science concerned with the application of meteorology to the measurement and analysis of the physical environment in agricultural systems.

4.1 IMPORTANCE

The word ‘**Agrometeorology**’ is the abbreviated form of agricultural meteorology to study the interaction between meteorological and hydrological factors on the one hand and agriculture in the widest sense, including horticulture, animal husbandry and forestry on the other (WMO). Agrometeorology deals with the behaviour of the weather elements, which have direct relevance to agriculture and their effect on crop production. Weather and climate are the important factors determining the success or failure of agriculture. Weather influences agricultural operations from sowing of a crop to the harvest and particularly rainfed agriculture depends on the mercy of the weather. In India every year there is a considerable damage by floods in one part of the country and a severe drought causing famines in another part. The total annual pre harvest losses for the various crops are estimated from 10 to 100%; while, the post harvest losses are estimated between 5 and 15%. Hence, Agrometeorology is very important in the following ways:

- Helps in planning cropping patterns/systems.
- Selecting of sowing dates for optimum crop yield.
- To go for cost effective ploughing, harrowing, weeding etc.
- Reducing losses of applied chemicals and fertilizers. Avoid fertilizer and chemical sprays when rain is forecast
- Judicious irrigation to crops.

- Efficient harvesting of all crops.
- Reducing or eliminating outbreak of pests and diseases.
- Efficient management of soils, which are formed out of weather action.
- Managing weather abnormalities like cyclones, heavy rainfall, floods, drought etc. This can be achieved by weather forecasting.
- Mitigation measures such as shelterbelts against cold and heat waves, effective environmental protection. etc.
- Avoiding or minimizing losses due to forest fires.

4.2 NEED AND SCOPE

The agrometeorology is needed since, the crops are to be sown at the optimum period for maximum yield. In dry lands, the time of receipt of rainfall decides the sowing date. Predicted onset of monsoon for premonsoon sowing. Study of agrometeorology helps to minimize the crop losses due to excess rainfall, cold/heat waves, cyclones etc. It helps in forecasting pests and diseases, choice of crops, irrigation and other intercultural operations through short, medium and long-range forecasts. It helps to identify places with same climatic conditions (Agroclimatic zones). This will enable to adopt suitable crop production practices based on the local climatic conditions. It also helps in the introduction of new crops and varieties, which are more productive than the native crops, and varieties. It helps in the development of crop weather models, which enables to predict crop productivity under various climatic conditions. It helps in the preparation of crop weather calendars for different locations. It enables to issue crop weather bulletins to farmers. It enables to forecast the crop yield based on weather to plan and manage food production changes in a region. It is needed to make the farmers more “weather conscious” in planning their agricultural operations.

The study of agrometeorology is needed for the following reasons:

- To study climatic resources of a given area for effective crop planning.
- To evolve weather based effective farm operations.
- To study crop weather relationships in all-important crops and forecast crop yields based on agro climatic and spectral indices using remote sensing.
- To study the relationship between weather factors and incidence of pests and diseases of various crops.
- To delineate climatic/agro ecological/agro climatic zones for defining agro climatic analogues so as to make effective and fast transfer of technology for improving crop yields.
- To prepare crop weather diagrams and crop weather calendars.
- To develop crop growth simulation models for assessing/obtaining potential yields in different agro climatic zones.
- To monitor agricultural droughts on crop-wise for effective drought management.
- To develop weather based agro advisories to sustain crop production utilizing various types of weather forecast and seasonal climate forecast.
- To investigate microclimatic aspects of crop canopy in order to modify them for increased crop growth.
- To study the influence of weather on soil environment on which the crop is grown
- To investigate the influence of weather in protected environment (*e.g.*, glass houses) for improving their design aiming at increasing crop production.

4.3 CLIMATOLOGY

Climatology is compounded of two Greek words, “*klima + logos*”; *klima* means slope of the earth, and *logos* means a study. In brief, climatology may be defined as the scientific study of climate. In the early civilization, Gods were often assigned to the climatic elements, Indians still hold ceremonial worships/dances to God’s to produce rains at times of drought. The Greek philosophers showed a great interest in meteorological science. It concerns with the integration of day-to-day weather over a period of time. It is very essential to differentiate the terms climate and weather.

A. Weather and Climate

In Climatology, the terms “Weather” and “Climate” have different connotations. **Weather** refers to the state of atmosphere at any give time denoting the short-term variations of atmosphere in terms of temperature, pressure, wind, moisture cloudiness, precipitation and visibility. It is highly variable, constantly changing, sometimes from hour to hour and at other times from day to day. The afore-mentioned properties of the atmosphere are subject to constant change and their state at any time determines the state of the weather. However, weather elements are not separate rather they are closely related with each other.

Climate on the other hand, is the sum or total of the variety of weather conditions of place or an area. It may be defined as the sum of all statistical weather information of a particular area during a specified interval of time, usually several decades. The WMO has suggested standard period of 31 years for calculating the climatic averages of different weather elements.

B. Factors affecting Weather and Climate

Latitude - Based on latitude, the climate has been classified as: (i) Tropical, (ii) Subtropical, (iii) Temperate and (iv) Polar. The tropical climate is characterized by high temperature throughout the year. Subtropical is also characterized by high temperature alternating with low temperature in winter. The temperate climate has low temperature throughout the year. The polar climate is noted for its very low temperature throughout the year.

Altitude (Elevation) - The height from the mean sea level creates variation in climate. Even in the tropical regions, the high mountains have temperate climate. The temperature decreases by 1.8°C for every 300 m from the sea level. Generally, there is a decrease in pressure and increase in precipitation and wind velocity. The above factors alter the kind of vegetation, soil types and the crop production.

Precipitation - The quantity and distribution of rainfall decides the nature of vegetation and the nature of the cultivated crops. The crop region are classified on the basis of average rainfall which are as follows:

<i>Rainfall (mm)</i>	<i>Climatic region</i>
Less than 500	Arid
500 - 750	Semi Arid
750 - 1000	Sub humid
More than 1000	Humid

Soil Type: Soil is a product of climatic action on rocks as modified by landscape and vegetation over a long period of time. The colour of the soil surface affects the absorption, storage and re-radiation of heat. White colour reflects while the black absorbs more radiation. Due to differential absorption of heat energy, variations in temperature are created at different places. In black soil areas, the climate is hot; while in red soil areas, it is comparatively cooler due to lesser heat absorption.

Nearness to large water bodies (Nearness to sea) - The presence of large water bodies like lakes and sea affects the climate of the surrounding areas. *e.g.*, Islands and coastal areas. The movement of air from earth surface and from water bodies to earth modifies the climate. The extreme variation in temperature during summer and winter is minimized in coastal areas and Islands.

Topography (relief) - The surface of landscape (leveled or uneven surface areas) produces marked changes in the climate. This involves the altitude of the place, steepness of the slope and exposure of the slope to light and wind.

Vegetation - Kind of vegetation characterizes the nature of climate. Thick vegetation is found in tropical regions where temperature and precipitations are high. General types of vegetations present in a region indicate the nature of climate of that region.

Other factors that affect the weather and climate are

- Semi permanent high and low pressure systems.
- Winds and air masses.
- Atmospheric disturbances or storms
- Ocean currents and mountain barriers.

C. Scales of Climate

- (i) **Microclimate** - Microclimate deals with the climatic features peculiar to small areas and with the physical processes that take place in the layer of air very near to the ground. Soil-ground conditions, character of vegetation cover, aspect of slopes, and state of the soil surface, relief forms—all these may create special local conditions of temperature, humidity, wind and radiation in the layer of air near the ground which differ sharply from general climatic conditions. It is concerned with the study of the properties of air near the ground and surface layer of soil, which falls under the microclimate.
- (ii) **Mesoclimate** - The scale of mesoclimate falls between micro and macroclimates. It is concerned with the study of climate over relatively smaller areas between 10 and 100 km across.
- (iii) **Macro climate** - Macroclimate deals with the study of atmosphere over large areas of the earth and with the large-scale atmospheric motions that cause weather. The scales of air motion in different climates are given in the Table 4.1 below.

Table 4.1. Scales of Air Motion in Different Climate

<i>Type of Climate</i>	<i>Horizontal scale (km)</i>	<i>Vertical scale (km)</i>	<i>Time scale (hrs)</i>
A. Macroclimate			
1. Planetary scale			
2. Synoptic scale	2000-5000 and more 500-2000	10 10	200-400 100
B. Mesoclimate	1-100	1-10	1-10
C. Microclimate	<100m	200 m	6-12 minutes

If any weather system develops under different types of climate, it persists longer periods under the macroclimate while smaller periods under microclimates.

4.4 COORDINATES OF INDIA AND TAMIL NADU

A. Definition

Coordinates: Latitude, longitude and altitude of a place as coordinates.

Latitude: Angular distance, measure in degrees, north or south from the equator.

Equator: An imaginary circle around the earth, equally distant at all points from both the North pole and the south pole. It divides the earth's surface into the northern hemisphere and the southern hemisphere.

Longitude: (Length) The distance of a place east or west on the meridian of Greenwich, England or the prime meridian as an angle is known as longitude.

Meridian: A great circle of the earth passing through the geographical poles and any given point on the earth's surface. (Geographical)

Altitude: Height of a place above the earth's surface or above sea level.

Coordinates of India

Area	: 3.28 m sq. km or 328 million ha
Longitude	: 68° E - 98° E
Latitude	: 8° N - 37° N
Distance form North to South	: 3214 km.
Distance form East to West	: 2933 km.
Land frontiers	: 15200 km.
Coast line	: 6083 km.

Coordinates of Tamil Nadu

Latitude	: 8°5' and 13° 10' N latitude
Longitude	: 76° 15' and 80° 20' E longitude
Costal line	: Approximately 1000 km.
Temperature range	: 29-38°C (maximum), 19-27°C (minimum)

4.5 ATMOSPHERE

Earth is elliptical in shape and has three spheres viz., 1. Hydrosphere—the water portion, 2. Lithosphere—the solid portion, and 3. Atmosphere—the gaseous portion. The atmosphere is the colourless, odourless and tasteless physical mixture of gasses, which surrounds earth on all sides. It is mobile, compressible and expandable. The uses of atmosphere are as follows:

- Provides oxygen which is useful for crop respiration
- Provides CO₂ to build biomass in photosynthesis.
- Provides N, which is essential for plant growth.
- Acts as a medium for transportation of pollen.
- Protects crops and human beings from harmful UV rays.
- Provides rain to field crops.

A. Composition

The atmosphere is a mechanical mixture of many gases, not a chemical compound. In addition, it

contains water vapour volume (4% of atmospheric composition) and huge number of solid particles, called aerosols. Some of the gases (N, O₂, Ar, CO₂) may be regarded as permanent atmospheric components that remain in fixed proportions to the total gas volume. Other constituents vary in quantity from place to place and from time to time. If the suspended particles, water vapour and other variable gases are excluded from the atmosphere, the dry air is very stable all over the earth up to an altitude of about 80 km. The principal gases comprising dry air in the lower atmosphere is given as follows:

<i>Constituents</i>	<i>% by volume</i>
Nitrogen (N ₂)	78.08
Oxygen (O ₂)	20.94
* Argon (Ar)	0.93
Carbon dioxide (CO ₂)	0.03
* Neon (Ne)	0.0018
* Helium (He)	0.0005
Ozone (O ₃)	0.00006
Hydrogen (H ₂)	0.00005
* Krypton (Kr)	Trace
* Xenon (Xe)	Trace
Methane (Me)	Trace

*Inert chemically never found in any chemical compounds.

(a) **Gases** - N and O₂ make up about 99% of the clean, dry air. The remaining gases are mostly inert and constitute about 1% of the atmosphere generally homogeneous and it is called as homosphere. At higher altitudes, the chemical constituent of air is changed considerably. The layer is known as the heterosphere.

N₂ - Relatively inactive chemically. It regulates combustion by diluting O₂ and indirectly helps oxidation. Mainly diluent.

CO₂ - Plants take CO₂ in the process of photosynthesis. It is an efficient absorber of heat from upper atmosphere as well as the earth. It emits half of the absorbed heat back to earth. It influences flow of energy through the atmosphere. The probation remains same but percentage increases due to burning of fossil fuels. From 1890 to 1970, CO₂ content has been increased more than 10 times, result in warming of lower atmosphere and climatic changes.

Ozone (O₃) - It is a type of oxygen molecule formed of three atoms rather than two. It is found only in very small quantity in the upper atmosphere. It is less than 0.0006% by volume. The maximum concentration of ozone is found between about 30 and 60 km. Although it is formed at higher levels and transported downward. It is the most efficient absorber of the burning UV radiation from the sun and acts as a filter. Absence of ozone layer will make the earth's surface unfit for human habitation - for all living organisms. Of all the gases, oxygen happens to be the most important for it is essential to all living organisms.

(b) **Water Vapour** - Water vapour is one of the most variable gases in the atmosphere, which is present in small amounts, but is very important. The water vapour content of air may vary from 0.02% by volume in a cold dry climate to nearly 4% in the humid tropics. The variations in this percentage over time and place are very important considerations climatically. Like CO₂, water vapour has insulating action of the atmosphere. It absorbs not only the long wave terrestrial radiation, but also

a part of the incoming solar radiation. Thus, it regulates energy transfer through the atmosphere. It is the source of all clouds and perceptions.

(c) **Dust particles:** Dust particles are a major contributory factor in the formation of clouds and fogs. It is responsible for the red, orange colour of the sky at sunrise and sunset.

B. Structure

The earth's atmosphere consists of zones or layers arranged like spherical shells based on altitude above the earth's surface. The atmosphere is divided into the following more significant spheres.

- Troposphere
- Stratosphere
- Ozonosphere (also called Mesosphere)
- Ionosphere, and
- Exosphere

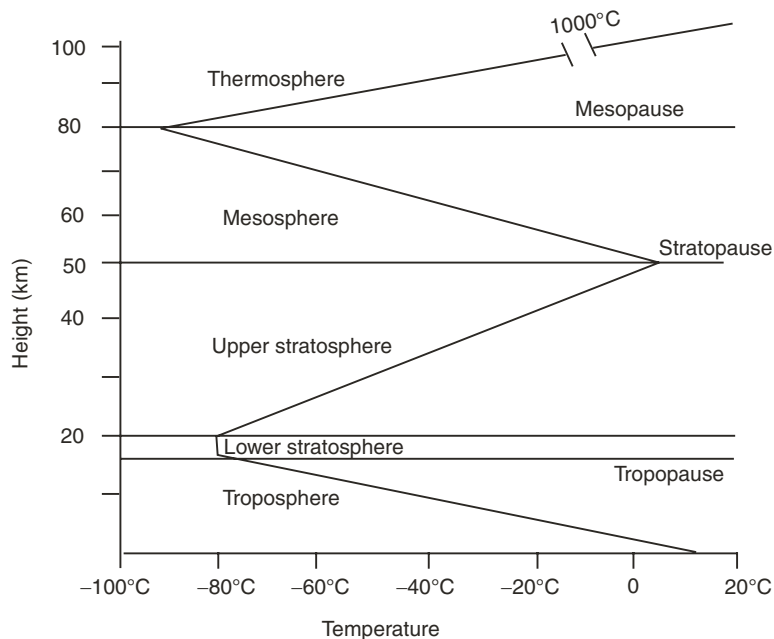

Fig. 4.1

Troposphere - It contains about 75% of the total gaseous mass of the atmosphere. It has been derived from the Greek word 'tropos' meaning "mixing" or turbulence. The average height of this lowermost layer of the atmosphere is placed at about 14 km above sea level. Under normal conditions, the height of the troposphere at the poles is about 8 km, while at the equator, it is about 16 km. A shallow layer separating troposphere from the next thermal layer of the atmosphere (stratosphere) is Tropopause. It is marked by turbulence and eddies. It is also called connective region. Various types of clouds, thunderstorms as well as cyclones and anticyclones occur in this sphere because of the concentration of almost all the water vapour (4% of the atmosphere composition) aerosols in it. Wind velocities increase with height and attain maximum at the top. Most important is decrease in temperature with increasing elevation up to 14 km.

Stratosphere - The stratosphere begins at the troposphere, which forms its lower boundary. The lower stratosphere is isothermal in character (16-30 km). There is a gradual temperature increase with

height beyond 29 km *i.e.*, upper stratosphere. There is no visible weather phenomena occur above tropopause.

Ozonosphere or Mesosphere - There is maximum concentration of ozone between 30 and 69 km above the surface of the earth. Because of the concentration of ozone in this layer, it is called the ozonosphere. It is a warm layer because of selective absorption of ultra violet radiation by ozone. In fact, it acts as a filter for ultra violet radiation from the sun. In this layer, the temperature increases with height @ 5°C/km. The maximum temperature recorded in the ozonosphere is higher than that at the earth’s surface. Because of the preponderance of chemical processes, this sphere is sometimes called as chemosphere.

Ionosphere - Ionosphere lies beyond the ozonosphere at a height of about 60 km above the earth’s surface. At this level, the ionization of atmosphere begins to occur. Above ozonosphere, the temperature falls again reaching a minimum of about 100°C at a height of 80 km above earth’s surface. Beyond this level, the temperature increases again due to the absorption of short wave solar radiation by the atoms of N in this ionosphere.

Layers of ionosphere

D Layer	:	60-89 km
E Layer	:	90-130 km
Sporadic Layer	:	110 km
E2 Layer	:	150 km
F1 Layer	}	150-380 km
F2 Layer		
G Layer	:	400 km and above.

Exosphere - The outer most layer of earth’s atmosphere is known as the exosphere, which lies between 400 and 1000 km. At such great height, density of atoms in the atmosphere is extremely low. Hydrogen and helium gases predominate in the outer most region. Kinetic temperature may reach 5568°C.

In modern view regarding the structure of atmosphere, the atmosphere is divided into two broad spheres on the basis of composition.

I. Homospheres

Homosphere means zone of homogenous composition height-up to 88 km. The proportions of the component gases of the sphere are uniform at different levels. It is sub-divided into:

- Troposphere – Very shallow transition layer - Tropopause
- Stratosphere – Stratopause
- Mesosphere – Mesopause

II. Heterosphere

The atmosphere above the homosphere is not uniform in composition. Different layers of the atmosphere in this part differ from one another in their chemical and physical properties. In this sphere, gases are said to be arranged into the following four roughly spherical shells, each of which has its own distinctive composite.

- (a) Nitrogen layer - 200 km above earth's surface -molecular N.
- (b) Oxygen layer - Average height 1120 km. - atomic oxygen
- (c) Helium layer - 3520 km
- (d) Hydrogen layer - Arranged based on the weight of the gases.

C. Lapse Rate

The decrease in air temperature with height is known as the normal/environmental lapse rate and it is 6.5°C/km.

Adiabatic lapse rate - The rate of change of temperature in an ascending or descending air mass through adiabatic process is called as adiabatic lapse rate. The thermodynamic transformation, which occurs without exchange of heat between a system and its environment, is known as adiabatic process. In adiabatic process, adiabatic cooling accompanies expansion, and adiabatic warming accompanies compression.

4.6 CLIMATE OF INDIA

Thorntwaite during 1931 and 1948 classified the climate using precipitation and evaporation/Potential evaporation and was subsequently modified by Mathur (1955) for the Moisture Index (Im) and is given below:

$$Im = 100 [(P-PE)/PE]$$

Where P = Precipitation, PE = Potential evapotranspiration

Using the moisture Index (**Im**), the following classification was made

<i>Im quantity</i>	<i>Climate classification</i>
100 and above	Per humid
20 to 100	Humid
0 to 20	Moist sub humid
-33.3 to 0	Dry sub humid
-66.7 to -33.3	Semi arid
-100 to -66.7	Arid

Another classification by Troll (1965) based on number of humid months, said to be of more agricultural use was modified by ICRISAT for India. Humid month is one having mean rainfall exceeding the mean PET.

<i>Climate</i>	<i>Number of humid months</i>	<i>% Geographical area of India</i>
Arid	< 2.0	17.00
Semiarid-dry	2.0-4.5	57.17
Semiarid-wet	4.5-7.0	12.31
Humid	> 7.0	1.10

The ICAR under All India Coordinated Research Project on Dry land Agriculture adopted classification based Moisture Deficit Index (MDI)

$$MDI = \frac{P - PET}{PET} \times 100$$

Where P is annual precipitation (cm) and PET is Potential Evapotranspiration. Based on MDI, the climate is divided into three regions as below.

Type of climate	MDI
Sub humid	0.0 to 33.3
Semi arid	-33.3 to -66.6
Arid	> -66.6

Temperature based Classification

The tropic of cancer, which passes through the middle of the country, divides it into two distinct climates. The tropical climate in the South where all the 12 months of the year have mean daily temperature exceeding 20°C; and in the North where a sub-tropical climate prevails. In sub-tropics during the winter months, it is cool to cold. Frosts occur sometime during the months of December and January. Some areas in the Northern India have a temperate climate. Here, it snows during the winter months and freezing temperatures may extend to two months or more during the year. Three main climatic zones of India based on temperature are shown in the map.

The weather elements affecting crop production are discussed in detail in the Chapter 3.

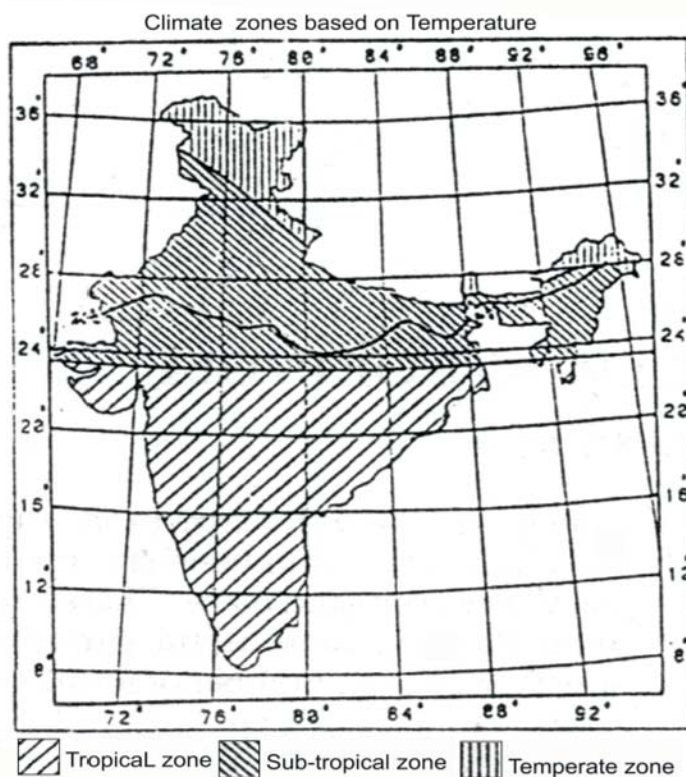

4.7 CLOUDS

Clouds have been defined as a visible aggregation of minute water droplets and/or ice particles in the air, usually above the general ground level.

A. Classification of Clouds

Clouds are usually classified according to their height and appearance. For convenience, we can list them in descending order *viz.*, high clouds, middle clouds and low clouds. We must exercise some caution in relying on height data. There is some seasonal as well as latitudinal variation and there is some overlapping form time to time. However, the appearance of clouds is quite distinctive for each height category.

WMO cloud classification (1957) - The WMO classified the clouds according to their height and appearance into 10 categories. From the height, clouds are grouped into 4 categories (*viz.*, family A, B, C and D) as stated below and there are sub categories in each of these main categories.

A. High clouds (mean heights 5–13 km) (Mean lower level 20000 ft)

- Cirrus (ci)
- Cirrocumulus (cc)
- Cirrostratus(cs)

B. Middle clouds (Mean heights 2–7 km) (6500–20000 ft)

- Altostratus (As)
- Altocumulus (Ac)

C. Low (clouds mean heights 0–2 km) (Close to earth's surface–6500 ft.)

- Nimbostratus (Ns)
- Stratocumulus (Sc)
- Stratus (St)
- Cumulus (Cu)
- Cumulonimbus(Cn)

Family A - The clouds in this category are high clouds. The mean lower level is 7 km and the mean upper level is 12 km in tropics and sub-tropics. In this family, there are three sub-categories:

1. **Cirrus (Ci)** - In these clouds ice crystals are present. It looks like wispy and feathery, and it is delicate, desist, white fibrous, and silky appearance. Sunrays pass through these clouds and sunshine without shadow. It does not produce precipitation.
2. **Cirrocumulus (Cc)** - Like cirrus clouds, ice crystals are present in these clouds also. It looks like rippled sand or waves of the seashore. It contains white globular masses and transparent with no shading effect. The sky is mackerel sky.
3. **Cirrostratus (Cs)** - Like the above two clouds, ice crystals are present in these clouds also. It looks like whitish veil and covers the entire sky with milky white appearance. It produces "Halo".

Family B - The clouds in this category are middle clouds. The mean lower level is 2.5 km and the mean upper level is 7 km in tropics and sub-tropics. In this family, there are 2 sub-categories.

1. **Altocumulus (Ac)** - In these clouds ice water is present. It has grayish or bluish globular masses. It looks like sheep back and also known as flock clouds or wool packed clouds.

2. **Alto-stratus (As)** - In these clouds, water and ice are present separately. It looks like fibrous veil or sheet and grey or bluish in colour. It produces coronas and cast shadow. Rain occurs in middle and high latitudes.

Family C - The clouds in this category are lower clouds. The height of these clouds extends from ground to upper level of 2.5 km in tropics and sub-tropics. In this family, there are 3 sub-categorizes.

1. **Strato cumulus (Sc)** - These clouds are composed of water. It looks soft and grey, large globular masses and darker than altocumulus. Long parallel rolls pushed together or broken masses. The air is smooth above these clouds but strong updrafts occur below.
2. **Stratus (St)** - These clouds are also composed of water. It looks like for as these clouds resemble grayish white sheet covering the entire portion of the sky (cloud near the ground). It is mainly seen in winter season and occasional drizzle occurs.
3. **Nimbostratus (Ns)** - These clouds are composed of water or ice crystals. It looks thick dark, grey and uniform layer, which reduces the daylight effectively. It gives steady precipitation. Sometimes, It looks like irregular, broken and shapeless sheet like.

Family D - These clouds form due to vertical development *i.e.*, due to convection. The mean low level is 0.5 km and means upper level goes up to 16 km. In this family, there are two sub-categories.

1. **Cumulus (Cu)** - These clouds are composed of water with white majestic appearance with flat base. Irregular dome shaped and looks like cauliflower with wool pack and dark appearance below due to shadow. These clouds usually develop into cumulo-nimbus clouds with flat base.
2. **Cumulonimbus (Cb)** - The upper levels of these clouds possess ice and water is present at the lower levels. These clouds have thunderhead with towering anvil top and develop vertically. These clouds produce violent winds, thunderstorms, hails and lightning, during summer.

B. Cloud Formation

Air contains moisture and this is extremely important to the formation of clouds. Cloud is formed around microscopic particles such as dust, smoke, salt crystals and other materials that are present in the atmosphere. These materials are called “Cloud Condensation Nucleus” (CCN). Without these, no cloud formation will take place. Certain special types known as “ice nucleus” on which cloud droplets freeze or ice crystals form directly for water vapour. Generally, condensation nuclei are present in plenty in air. But there is scarcity for special ice forming nuclei. Generally, clouds are made up of billions of these tiny water droplets or ice crystals or combination of both. There are two rain forming process, *viz.*, 1. Warm rain process (rain fall process in the tropics), and 2. Cold rain process.

Warm rain - Rain occurs when the temp is above 0°C never colder than 0°C and when larger droplets collide and absorb smaller cloud droplets. They grow larger and larger and become raindrops. This process is known as “Coalescence cold rain process”.

Cold rain - It occurs when the cloud temperature is colder than 0°C. Clouds are usually with ice crystals and liquid water droplets. These crystals grow rapidly drawing moisture from the surrounding cloud droplets until their weight-causes them to fall. Falling ice crystals may melt and join with smaller liquid cloud droplets. Resulting in raindrops if ice crystals do not melt, they may grow into large snowflakes and reach the ground as snow.

C. Conditions Favourable for the Occurrence of Precipitation

- The cloud dimension (vertical - 7 km horizontal 60–70 km).
- The lifetime of the cloud (at least 2–3 hrs.)

- The size and concentration of cloud droplets and ice particles.
- RH should be 75%.
- Wind velocity (20 km).
- Cloud seeding.

D. Principles of Rainmaking

Clouds are classified into warm and cold clouds based on cloud top temperature. If the cloud temperature is positive, these clouds are called warm clouds and if it is negative, they are called as cold clouds. The nucleus needed for precipitation differs with type of clouds. Hygroscopic materials are necessary as nucleus for warm clouds.

Cloud seeding - It is the process by which the conditions of the cloud, (dimension, life time and size) are modified by supplying them with suitable nucleus at proper time and place. For accelerating the warm rain process, seeding with very large nuclei such as salt crystals can be used. In the case of cold rain process, seeding with ice nuclei such as silver iodide are used.

Cloud seeding is one of the tools to mitigate the effects of drought. It is defined as a process in which the precipitation is encouraged by injecting artificial condensation nuclei through aircrafts or suitable mechanism to induce rain from rain bearing cloud. The raindrops are several times heavier than cloud droplets. These mechanisms are different for cold and warm clouds.

(a) Seeding of cold clouds

This can be achieved by two ways as given below:

1. **Dry ice seeding** - Dry ice (solid carbon-dioxide) has certain specific features. It remains as it is at -80°C and evaporates, but does not melt. Dry ice is heavy and falls rapidly from top of cloud and has no persistent effects due to cloud seeding. Aircrafts are commonly used for cloud seeding with dry ice. Aircraft flies across the top of a cloud and 0.5-1.0 cm dry ice pellets are released in a steady stream. While falling through the cloud, a sheet of ice crystals is formed. From these ice crystals, rain occurs. This method is not economical as 250 kg of dry ice is required for seeding one cloud. To carry the heavy dry ice over the top of clouds special aircrafts are required, which is an expensive process.
2. **Silver Iodide seeding** - Minute crystals of silver iodide produced in the form of smoke acts as efficient ice-forming nuclei at temperatures below -5°C . When these nuclei are produced from the ground generators, these particles are fine enough to diffuse with air currents. Silver iodide is the most effective nucleating substance because; its atomic arrangement is similar to that of ice. The time for silver iodide smoke released from ground generator to reach the super cooled clouds was offer some hours, during which it would draft a long way and decay under the sun light. The appropriate procedure for seeding cold clouds would be to release silver iodide smoke into super cooled cloud from an aircraft. In seeding cold clouds, silver iodide technique is more useful than dry ice techniques, because, less quantity of silver iodide is required per cloud. There is no necessity to fly to the top of the cloud, if area to be covered is large.

(b) Seeding of warm clouds

1. **Water drop technique** - Coalescence process is mainly responsible for growth of rain drops in warm cloud. The basic assumption is that the presence of comparatively large water droplets is necessary to initiate the coalescence process. So, water droplets or large hygroscopic nuclei are

introduced into the cloud. Water drops of 25 mm are sprayed from aircraft at 30 gallons per seeding on warm clouds.

2. **Common salt technique** - Common salt is a suitable seeding material for seeding warm clouds. It is used either in the form of 10% solution or solid. The spraying is done by power sprayers and air compressors or even from ground generators. The balloon burst technique is also beneficial. In this case, gunpowder and sodium chloride are arranged to explode near cloud base dispersing salt particles.

4.8 MONSOON RAINFALL VARIABILITY

India receives its annual rainfall by the peculiar phenomenon known as monsoon. It consists of series of cyclones that arise in Indian Ocean and Bay of Bengal. These travel in north-east direction and enter the Peninsular India along its west coast. The most important of these cyclones usually occur from June to September resulting in summer monsoon or south-west monsoon. This is followed by a second rainy season from October to December. A third and fourth rainy seasons occur from January to February and from March to May respectively. Of the four rainy seasons, south-west monsoon is the most important as it contribute 80–95% of the total rainfall of the country.

- (a) **South West Monsoon (SWM)** - In the beginning of the year, temperature of the Indian Peninsular rapidly rises under the increasing heat of the sun. A minimum barometric pressure is established in the interior parts of the Peninsular by the month of March. Westerly winds prevail on the west Kerala and south winds on the west of Orissa and Bengal. During April and May, the region of high temperature is shifted to north viz., upper Sind, lower Punjab and western Rajasthan. This area becomes the minimum barometric pressure area to which monsoon winds are directed. The western branch of SWM touches north Karnataka, southern Maharashtra and then it make its way to Gujarat. When the South West Monsoon is fully operating on the Western India, another branch of the same is acting in the Bay of Bengal. It carries rains to Burma, Northern portions of the east coast of India, Bengal, Assam and the whole of North India in general.
- (b) **North East Monsoon (NEM)** - During September end, the SWM penetrates to north western India but stays on for a full month in Bengal. On account of the increase in barometric pressure in Northern India, there is a shift of the barometric pressure to the South East and North Easterly winds begin to flow on the eastern coast. These changes bring on heavy and continuous rainfall to the southern and south eastern India.
- (c) **Winter rainfall** - It is restricted more to northern India and is received in the form of snow on the hills and as rains in the plains of Punjab, Rajasthan and central India. Western disturbance is a dominant factor for rainfall during these months in northwestern India.

Table 4.2 Rainfall Distribution in Tamil Nadu in Different Seasons

<i>Rainfall Season</i>	<i>Quantity (mm)</i>	<i>Share (%)</i>
South West Monsoon	311.7	32
North East Monsoon	457.8	47
Cold weather period	48.7	5
Hot weather period	155.9	16

- (d) **Summer rainfall** - The summer rainfall is received from March to May as local storms. It is mostly received in the South-east of Peninsular and in Bengal. Western India does not generally receive these rains.

4.9 EVAPORATION, TRANSPIRATION AND ET

A. Evaporation

The change of state of water from solid and liquid to the vapour and its diffusion into the atmosphere is referred to as evaporation. In agricultural meteorology, evaporation is defined as the maximum possible loss of moisture from a wet, horizontal, flat surface exposed to weather parameters, which exist in the vicinity of plants. Evaporation is an important process of hydrologic cycle. The evaporation from the soil is an important factor deciding the irrigation water requirements of a crop. In modifying the microclimate of a crop, the evaporation from the soils is an important factor. It is the most important of all the factors in the heat budget, after radiation and in the water economy. Since, a certain amount of evaporation also demands a definite amount of heat, it provides a link between water budget and heat budget.

Factors affecting evaporation - The evaporation from a fully exposed water surface is the function of several environmental factors.

1. Environmental factors

Water temperature - With an increase of temperature, the kinetic energy of water molecules increases and surface tension decreases which increases evaporation.

Wind - The evaporation from fully exposed surface is directly proportional to the velocity of wind and vice-versa, because dry wind replaces the moist air near water. The process of evaporation takes place continuously when there is a supply of energy to provide latent heat of evaporation (540 calories/gram of water).

Relative humidity - The evaporation is greater at low RH than at high RH.

Pressure - The evaporation is more at low pressure and less at high pressure.

2. Water factors

Composition of water - The dissolved salts and other impurities decrease the rate of evaporation. The evaporation is inversely proportional to the salinity of water.

Area of evaporation - The larger the area of exposure, greater will be the evaporation. Those affecting water supply at the evaporating surface. *i.e.*, soil and plants including soil storage capacity, rainfall and irrigation and those affecting energy supply to the evaporating surface like solar radiation.

B. Transpiration

Most of the water absorbed by plants is lost to the atmosphere. This loss of water from living plants is called transpiration. It can be stomatal, cuticular or lenticular. It plays an important role in dissipation of radiant energy by plant parts, translocation of water in the plants and translocation of minerals in the plant.

Factors affecting transpiration

(i) Environmental factors

Light: By directly opening and closing of the stomata, there is periodicity in the transpiration rate. Indirectly by increasing the temperature of leaf cells, the transpiration is increased.

Atmospheric humidity: The rate of transpiration is almost inversely proportional to atmospheric humidity.

Air Temperature: Increase in temperature results in opening of stomata, which in turn increase transpiration.

Wind velocity: The higher the wind speed, higher the transpiration.

(ii) *Plant factors*

Plant height: Water need of the crop varies with height.

Leaf characteristics: Reduction in leaf area brings reduction in transpiration.

Availability of water to the plant: If there is little water in the soil, the tendency for dehydration of leaf causes stomatal closure and a consequent fall in transpiration.

C. Evapotranspiration (ET)

Evapotranspiration denotes the quantity of water transpired by plants or retained in the plant tissue plus the moisture evaporated from the surface of the soil. As long as the rate of root uptake of soil moisture balances the water losses from the canopy, evapotranspiration continues to occur at its potential rate. When the rate of root water uptake falls below the transpiration demand, actual transpiration begins to fall below the potential rate. This is either because the soil cannot supply water to roots quickly or the plant can no longer extract water to meet the evaporation demand.

D. Reference Evapotranspiration (ET_0)

This represents the maximum rate of evapotranspiration from an extended surface of 8–10 centimeters tall green grass cover, actually growing and completely shading the ground under limited supply of water.

Potential evapotranspiration (PET) - Potential evapotranspiration (PET) for any crop is obtained from reference evapotranspiration and crop factors (K_c) when water supply is unlimited.

$$PET = K_c \times ET_0$$

Evapotranspiration is also called water use (WU) or consumptive use (CU). The factors influencing ET are climate and management practices.

(a) *Importance of ET and PET*

- Estimation of the soil moisture thereby planning irrigation schedule of crops.
- Understanding the relationship between the crop yield and irrigation water.
- Guiding for the production of a crop with a fully developed canopy.
- The evapotranspiration can also help to demarcate soil climatic zones including the drought prone areas.
- These will form the base for developing suitable soil and crop management practices, crop varieties, water conservation techniques, cropping pattern and ways to improve productivity rainfed crops.

(b) *Factors affecting ET*

- Those affecting water supply *i.e.*, soil storage capacity, rainfall and irrigation.
- Those affecting energy supply.
- Light
- Temperature
- Relative Humidity

- Wind
- Plant character - root/shoot-ratio, leaf characteristics and thick cuticle.

4.10 HYDROLOGIC CYCLE

Hydrologic cycle involves four major steps *viz.*, evaporation, transpiration, condensation and precipitation. Though the cycle has neither a beginning nor an end, the concept of cycle begins with the water of the oceans, since it covers nearly $\frac{3}{4}$ of the earth's surface. Radiation from the sun evaporates the water as water vapour from the oceans into the atmosphere. The water vapour rises and collects to form clouds. Under certain conditions, the cloud moisture condenses and falls back to the earth as rain, snow, hail etc. Precipitation reaching the earth's surface may be intercepted by vegetation, enter into the soil, may flow as run or may evaporate. Evaporation may be from the surface of the ground or from free water surface. Transpiration may be from plants.

A. Monsoons of India

The term monsoon is derived from an Arabic word 'Mausim' or from Malayan word 'monsin' which means 'season'. The word monsoon is applied to such a circulation, which reverses its direction every six months *i.e.* from summer to winter and vice-versa. The economic significance of monsoon is enormous, because a population of more than 2000 million lives, *i.e.*, roughly about half the world's population (54%), depends on the monsoon rains for their crops. Moreover, a large percentage of total population in the monsoon region derives its income from agriculture. In India, monsoon means life-giving rains. Failure of monsoon rains cause loss of food crops. Erratic behaviour of monsoon cause disastrous floods in some parts of the country while in other parts there is severe drought.

During the hot, dry season (April-May), when temperatures rise rapidly and pressures over land decrease, the warm and moist air form over the adjacent seas starts blowing, towards the above-mentioned low pressure centre. However, in the beginning the maritime, air masses are drawn only from a short distance. But by the end of May or the first week of June, when the low pressure centre has fully developed, the pressure-gradient is steeped so that even the trade winds from southern hemisphere are drawn towards the thermal low positioned in north-western region of the sub-continent. The southerly trades on crossing the equator are deflected to their right in accordance with Ferrell's Law. Now, the originally south-east trade winds become southwesterly blowing towards north-east. Southwesterly on-shore winds blowing towards the centre of low pressure over northern India traverse thousand of miles over the warm tropical ocean. They are, therefore, full of moisture and have a great potential for heavy precipitation. The south-west monsoon, as it is called in this region, is split into two branches by the shape of Peninsular India. They are known as: (a) the Arabian Sea branch, and (b) the Bay of Bengal branch.

- (a) **Arabian Sea branch** - The Arabian sea branch strikes the elevated western ghats of India at almost right angles. The windward slopes of western ghats receive heavy orographic precipitation. However, the westerly current from the Arabian Sea continues its journey across the Indian Peninsula, but the amount of rainfall on the leeward side goes on diminishing with increasing distance from the sea coast. The western ghats have 100–250 cm of rainfall on their windward slopes, while there is a well-marked rain-shadow to the leeward. Towards the north, where western ghats are not very high, the difference in the amount of rainfall between the windward and leeward side is rather negligible. Some of the air currents from the Arabian sea branch manage to proceed towards Chhota Nagpur plateau through the Narbada and Tapit gaps. These air currents ultimately unite with the Bay of Bengal branch.

- (b) **Bay of Bengal branch** - One current of the Bay of Bengal branch moves towards Assam where Mawsinram (near Cherapunji), situated on the southern slope of Khasi hills, has the unique distinction of recording the highest annual average precipitation (965 cm) in the world. This is because of its peculiar geographical location. A current of the Bay of Bengal branch recurves westward and advances up to the gangetic plain towards the Punjab. It may be mentioned that the westward movement of monsoon current takes place around the eastern end of a trough of low pressure developed over northern India. The movement of winds is, of course, parallel to the Himalayan ranges. The rainfall occurring in the Gangetic plain is partly controlled by the relief, and partly by the cyclonic storms or monsoon depressions, which followed the track of low relief and low pressure along southern fringe of the plains. It is to be noted that in this region, the monsoon current blows from a south-east direction. The rainfall decreases from east to west and from north to south. The main reason for decrease in amount of rainfall westwards is the increasing distance from the source of moisture. The southward decrease in rainfall is due to the increasing distance from the Himalayas, which cause the forced ascent of rain bearing air currents.
- (c) **Winter Monsoon** - A secondary high pressure system develops over Kashmir and the Punjab. The high pressure area controls the prevailing wind direction over the rest of the subcontinent. Contrary to the pressure condition over land, there are low pressure centres formed over the Indian ocean, the Arabian sea, and northern part of Australia. In the cool season, therefore, there is pressure gradient from land to sea as a result of which winds begin to move from land to sea. These are the north-east or winter monsoons of northern hemisphere. The southern part of Indian Peninsula receives rainfall from north-east monsoon currents. These currents while traveling over the Bay of Bengal pick up moisture from warm ocean surface. The amount of winter rainfall on the eastern side of the peninsula is much heavier than that on the other side. It is also known as retreating monsoon.

4.11 FLOOD

Years in which actual rainfall is 'above' the normal by twice the mean deviation or more is defined as years of floods or excessive rainfall. Like droughts, the definition of floods also varies one situation to another and from one region to other or high degree of runoff is known as flood. Runoff is that portion of precipitation that returns to the oceans and other water bodies over the land surface or through the soil and water table. The factors affecting runoff are the amount and intensity of precipitation, temperature, characters of the soil, vegetative cover of the area and slope of the land. It may be a direct return of rainfall or the flow from melted snow and ice fields-which have temporarily stored water. When rain occurs, the proportion of runoff will depend on capacity of the soil and vegetation to absorb. Plants retain some rainfall on their external structures and slow the velocity of raindrops. They also detain water in its horizontal movement. Plants improve soil structure and their roots provide channels to move water to greater depths. The high humus content of soils with dense grass cover enhances absorption than impervious sub-soil.

Some of the flood years due to high and intense rainfall in India are as follows.

1878, 1872, 1917, 1933, 1942, 1956, 1959, 1961, 1970, 1975, 1983, 1988, 2005, 2006

Flood differs from simple runoff only in degree. Distinction between the two depends upon how they affect surface features. River floods occur whenever the channel capacity is exceeded by the runoff due to excessive runoff of rainfall or snow melt. But, the channel capacity may also be affected by

barriers to flow, sudden change of direction of stream, siltation of the streambed, or sudden release of water due to broken dam.

(a) **Climatic causes** - The predisposition of a climate to storms producing excessive precipitation is the fundamental basis of the flood. In some cases, storms occur irregularly; in others they follow a seasonal pattern. Two types storms causing flood are:

- Violent thunder showers, which is of short duration and produces a flash flood.
- Prolonged wide spread rain which through sheer quantity of water, creates extensive flooding over entire watersheds.

(b) **Damages** - The damages due to flood are:

- Loss of human life, cattle wealth and properties.
- Loss of field crops, soil-may vary according to the duration and intensity of flooding.

Not all floods are “bad” for agricultural areas in the lower-Nile flood plain and Mesopotamia depend on annual river flooding and the accompanying deposits of fertile silt.

(c) **Management of flood** - For managing flood, the following measures may be taken.

- Conserve water in the soil where it falls by increasing porosity of the soil and growing vegetations to reduce runoff.
- Increase the capacity of channels (rivers) to carry excess water direct to the ocean or to the water bodies for storage.
- Avoid silting of water courses to conserve soil by adopting soil conservation techniques such as by vegetative barriers, counter bunding, contour cultivation, allowing grassy water ways etc.

The most injurious aspects of flooding or too much of water are lack of aeration and reduction in oxygen supply. In wet soil, nitrification suffers which causes yellowing and sticky appearance of plants. The following measures may be taken for the crops affected by flood.

- Drain away excess water as early as possible.
- Give a foliar spray of nutrients especially N for immediate relief *e.g.*, rice: 1.0% urea + 0.5% ZnSO₄.
- Spray fungicides to protect the crop from fungal diseases, which are common under high moisture condition.

4.12 WEATHER ABERRATIONS

1. **Dry spells** - The interval between the end of a seven day wet spell, beginning with the onset of effective monsoon and another rainy day with 5 e mm of rain (where “e” is the average daily evaporation) or the commencement of another seven day rainy spell with four of these as rainy days (satisfying the third criterion) and with a total rain of 5 e mm or more during this spell is called the **first dry spell**. If the duration of this dry spell exceeded certain value, depending on the crop-soil complex of the region, this dry spell was called a **critical dry spell**. Criteria for forecasting rainfall characteristics (like onset of effective monsoon) are as follows:

- The first day rain in the 7-day spell signifying the onset of effective monsoon, should not be less than “e” mm.
- The total rain during the 7-day spell should not be less than 5 e + 10 mm.
- At least four of these seven days should have rainfall, with not less than 2.5 mm of rain on each day.

2. **Wet spell** - A wet spell is defined as a rainy day with “X” mm of rainfall or a 7 day spell where the total amount of rainfall equals “x” mm or more and the condition that three out of these seven days must be rainy with rainfall more than 2.5 mm on each day. In this, “x” is the amount of rainfall, which brings the top 50 cm soil layer to field capacity. The water holding capacity varies with the type of soil. For example, the value of “x” is equal to 83 mm for light soils, 125 mm for medium soils and 166 mm for heavy soils of Punjab.
3. **Critical Dry Spell (CDS)** - CDS is defined as the duration between the end of a wet spell and the start of another wet spell during which a 50% depletion of available moisture occurs in the top 50 cm soil layer. It is calculated by the following formula.

$$\text{CDS} = \frac{\text{AMD}}{\text{ET}}$$

Where CDS in day; AMD = 50% of the available soil moisture in the top 50 cm soil layer, expressed in terms of depth (mm); ET = Average maximum daily ET of a crop (mm/day).

4. **Drought** - Drought has varied meanings for different people. In general, drought may be defined as a complex phenomenon, which results from the prolonged absence of precipitation in conjunction with high rate of evaporation. This causes abnormal loss of water form water bodies, lowering of the water table and dehydration of the root zone of the soil, thus upsetting water supply to plants. The term drought can be defined by several ways.
 - The condition under which crops fail to mature because of insufficient supply of water.
 - The situation in which the amount of water required for transpiration and evaporation by crop plants in a defined area exceeds the amount of available moisture in the soil.
 - A situation of no precipitation in a rainy season for more than 15 days continuously. Such length of non-rainy days can also be called as dry spells.

The details on classification of drought is given in the chapter 13 (Section 13.3 B)

5. **Aberrations in rainfall** - Aberration means the deviation from the normal behaviour of the rainfall. As the principal source of water for dry land crops is rain, a major portion of which is received during the monsoon period. Bursts of rain alternated with “Breaks” are not uncommon. There are at least four important aberrations in the rainfall behaviour.
 - The commencement of rains may be quite early or considerably delayed.
 - There may be prolonged breaks during the cropping season (Intermittent drought).
 - The rains may terminate considerably early (early cessation of rain) or continue for longer periods.
 - There may be spatial and/or temporal aberrations.

(a) **Early or delayed onset of monsoon** - To quantify the aberrations in the onset of monsoon, 50 years of data to be analyzed for the date of onset of monsoon has to be studied for different regions of the country. The aberrations require changes in crops and varieties with the normal onset of NEM (Sep.–Oct.). Crops like sorghum, bajra, pulses and oil seeds can be grown in Kovilpatti tract of Tamil Nadu with the onset of monsoon. If monsoon is delayed up to late October, crops like bajra, pulses, sunflower etc., can be raised. If it is very much delayed up to first week of November, crops like sunflower can be sown.

(b) **Breaks in the monsoon rains-Intermittent drought** - The breaks can be of different durations. Breaks of shorter duration (5–7 days) may not be a serious concern, but breaks of 2–3 weeks or even more, lead to plant-water stress causing reduction in production. This intermittent drought can be of

different magnitude and severity, and affect different crops in varying degrees. The yields of sensitive crops are seriously affected but not drought resistant crops. Another aspect of the breaks or intermittent drought is the stage of the crop at which the drought occurs. The effect on crop will be different at different stages. Another important factor is the effect of breaks or intermittent drought depends on the physical properties of the soil particularly its water holding capacity. Deep black soils have capacity to store as much as 300 mm of available soil moisture in one meter depth, whereas light soils can store only as little as 100 mm or so. Hence drought is more pronounced in the soils having less storage capacity.

(c) **Early withdrawal of monsoon** - The normal withdrawal of SWM in Rayalaseema region will be between 25th September and 15th October. But, in 4% of the years out of 55 years, monsoon withdraws during first fortnight of September and in 10% of the years, it withdraws during the month of December. Since, crops and varieties in any given region are selected based on the normal length of growing season. Persistence of rains much beyond normal dates creates an extraordinary situation. Under Kovilpatti (Tamil Nadu) conditions, short duration bajra and sunflower will be suitable under early withdrawal of monsoon. Cultural practices to mitigate the effect of moisture stress due to intermittent drought and early withdrawal of monsoon are: (a) shallow intercultural operations to eradicate weeds, (b) maintain soil mulch to conserve soil moisture, (c) application of surface mulch, (d) thinning of crops by removing alternated rows as in sorghum and bajra, (e) recycling of stored run off water, (f) ratooning in crops like sorghum and bajra, and (g) 2–3% urea spray after a rain for indeterminate crops like castor and red gram.

(d) **Uneven distribution of monsoon rains, in space and time** - This situation is encountered almost every year in one or another part of the country during monsoon period leading to periodical drought and flood situations. High variability of rainfall is the single factor which influences the high fluctuations in the crop yields in the different parts of the country.

4.13 AGROCLIMATIC ZONES

Climate in general, is the totality of weather observed over wide area for a longer period. An agroclimate can be defined as the conditions and effects of varying weather parameters like solar radiation, rainfall, etc., on crop growth and production. Agroclimatic classification is a method of arranging various data of climatic parameters to demarcate a country or region into homogenous zones, *i.e.*, places having similar conditions.

A. Advantages

The classification would enable in exploring agricultural potentiality of the area. Locating similar type of climate zone will enable in identifying the specific problems of soil and climate related to agriculture. It will help in introduction of new crops from other similar areas *e.g.*, introduction of oil palm in Tamil Nadu and Kerala from Malaysia. It will help in developing crop production technologies, specific to the region. The classification will be useful to take up research work to solve the regional problems and to transfer the technology easily among the farmers.

B. Agroclimates of India

Krishnan and Muktar Singh (1969) have classified India into eight major agroclimatic zones using Thornthwaite moisture index and thermal index. The moisture index is given by the following formula.

$$MI = \frac{P - PE}{PE} \times 100$$

where MI = Moisture Index
 P = Precipitation/rainfall
 PE = Potential evapotranspiration

Based on the indices, eight moisture and four thermal belts were formed. All together there are 32 sub-zones. During the year 1989, the Planning Commission made an attempt to delineate India into different agro-climatic zones. Based on the similarity in rainfall, temperature, soil topography, cropping, farming system and water resources, India has been divided into fifteen agro-climatic regions. This was done mainly to identify the production constraints and to plant future strategies.

4.14 AGROCLIMATIC NORMAL

Crop yields are influenced by external and internal factors that occur during the crop growing period. The external environment is the climate, which regulates and determines the growth and development and final output of crop plants. But, man has no control over weather alone, because its dominance over the success or failure of agricultural enterprises. According to the WMO, the weather-induced variability in crop yields is as high as 50%. Therefore, weather should be taken as one of the inputs in agricultural planning. Under optimum climatic conditions, the plants manifest their maximum growth and production. Different crop growth cycles demand different climatic condition for fulfillment. Green houses where every growth factor can be controlled and growth chambers for maximum production of a crop are not available in plenty. Alternatively, the climate of a region where a particular crop is best grown with less pest and diseased incidence can be studied elaborately.

A. Definition

Climatic normal means the degree of temperature, amount of rainfall, humidity, etc., which distinguish optimal conditions from abnormal, both because of excess and insufficiency. The climatic normal is the average value of 30 years of a particular weather element. The period may be a week/month and/or year. The crop distribution, production and productivity depend on the climatic normal of a place. If the crops are selected for cultivation based on the optimum climatic requirements, the crop production can be maximized. The uses of studying Agro-climatic normal for field crops can be as follows:

- Useful for agricultural planning.
- Useful in introduction of any crop. *e.g.*, introduction of groundnut in peninsular India from Africa and long grained patnai rice into California.
- Useful to forecast the abnormal weather.

B. Climatic Normal for Crop Plants

1. Rice

Besides rainfall, temperature and solar radiation influence rice yield by directly affecting the physiological processes involved in grain production and indirectly through the incidence of pest and diseases.

Temperature - The difference in yield is mainly due to temperature and solar radiation received during its growing season. It requires high temperature, ample water supply and high atmospheric humidity during growth period. Rice tolerates up to 40°C provided water is not limiting. A mean temperature of 22°C is required for entire growing period. If high temperature drops lower than 15°C during the growth phase, the rice yield is greatly reduced by formation of sterile spikelets. The period

during which low temperature is most critical, is about 10–14 days before heading. The optimum temperature requirements for the different stages of rice crop are given in the Table 4.3.

Table 4.3. Optimum Temperature Requirements for Rice

<i>Growth stages</i>	<i>Temperature in °C</i>		
	Low	High	Optimum
Germination	10	45	20–35
Seedling establishment	12–13	35	25–30
Rooting	16	35	25–28
Leaf elongation	9–18	38	31
Tillering	9–16	33	25–31
Panicle initiation	15–20	38	33
Anthesis	22	35	30–32
Ripening	12–18	30	20–25

Solar radiation - Low sunshine hours during the vegetative stage have slight ill effect on grain production, whereas the same situation during reproductive stage reduce the number and development of spikelets and thereby the yield. For getting grain yield of 5 t/ha, a solar radiation of 300 cal.cm²/day is required. A combination of low daily mean temperature and high solar radiation during reproductive phase is good for getting higher yield.

Rainfall - Rice requires high moisture and hence classified as hydrophytes. Rice requires a submerged condition from sprouting to milky stage. The water requirement is 125 cm. An average monthly rainfall of 200 mm is required to grow low land rice and 100 mm to grow upland rice successfully.

2. Wheat

Temperature - Optimum temperature for sowing is 15–20°C. At maturity, it requires 25°C. At harvest time, wheat requires high temperature of 30–35°C and bright sunny period of 9–10 hours.

Moisture - One ha of wheat consumes about 2500–3000 tones of water. Water deficiency at the heading stage results in shriveled grains and low yield.

3. Maize

This crop is best suited for intermediate climates of the earth to which the bulk of its acreage is confined.

Temperature - Maize requires a mean temperature of 24°C and a night temperature above 15°C. No maize cultivation is possible in areas where the mean summer temperature is below 19°C or where the average night temperature during the summer falls below 21°C. However, high night temperature also results in low yield.

Moisture - Maize is adapted to humid climates and has high water requirements. It needs 75 cm of rainfall during its growth period. The average consumptive use of water by maize is estimated to range between 41 and 64 cm. From germination up to the earing stage, maize requires less water. However, at flowering, it requires more water and the requirement reduces towards maturity.

4. Groundnut

Temperature - It is a tropical crop. It can be raised under a wide range of temperature. However, both very high and low temperature adversely affects the groundnut. A temperature range of 14–16°C is necessary for seed germination. Higher temperature results in better performance in terms of length of

stem, number of flowers and the number of pods. Maximum pods have been harvested at a mean soil temperature of 23°C. The number of pods decreases as the temperature increases.

Moisture - Rainfall of 75–125 mm during summer months preceding sowing, 125–175 mm during a fortnight after sowing and 370–600 mm of well distributed rainfall during the crop growth.

5. Cotton

It requires 4-5 months of uniformly high temperature (28–45°C) during its crop growth period. Mean air temperature of 21–29°C is required at vegetative period. The optimum air temperature for reproductive phase is 27–32°C; mean sunshine hours are 8-9 hrs/day; and mean RH is 70%. But at boll development and boll opening period (September to November), RH less than 70% and 8 hrs. of sunshine are ideal for good cotton production. The growth rate of cotton crop is increased at 25–30°C. Temperature below 15°C retards growth and reduces the square (bud) formation.

Moisture - The minimum rainfall required for cotton is 500–650 mm. Heavy rainfall during early stage is undesirable. Dry autumn months are desirable for good quality produce. Excess rainfall at later stage may cause shedding of leaves, squares and bolls. It also stimulates top growth, delays maturity and changes colour of lint. High humidity favours many pests and diseases.

6. Sugarcane

Mean temperature for optimum germination is 30°C. Mean temperature for optimum growth is 35°C. At temperature less than 20°C, growth is reduced. Ideal climate is 4–5 months of hot period with temperature of 30–35°C followed by 6–8 weeks of cooler period for better maturity.

4.15 WEATHER FORECASTING

Weather is the most important factor, which influences agricultural operations and crop production. A substantial portion of crop is lost due to aberrant weather. The pre-harvest loss may range between 10 and 100% in various crops. The post-harvest loss is mainly due to rains and excessive humidity. **Weather forecast** is the prediction of weather for the next few days to follow. The Figure below depicts different weather forecasting services normally practiced in a country.

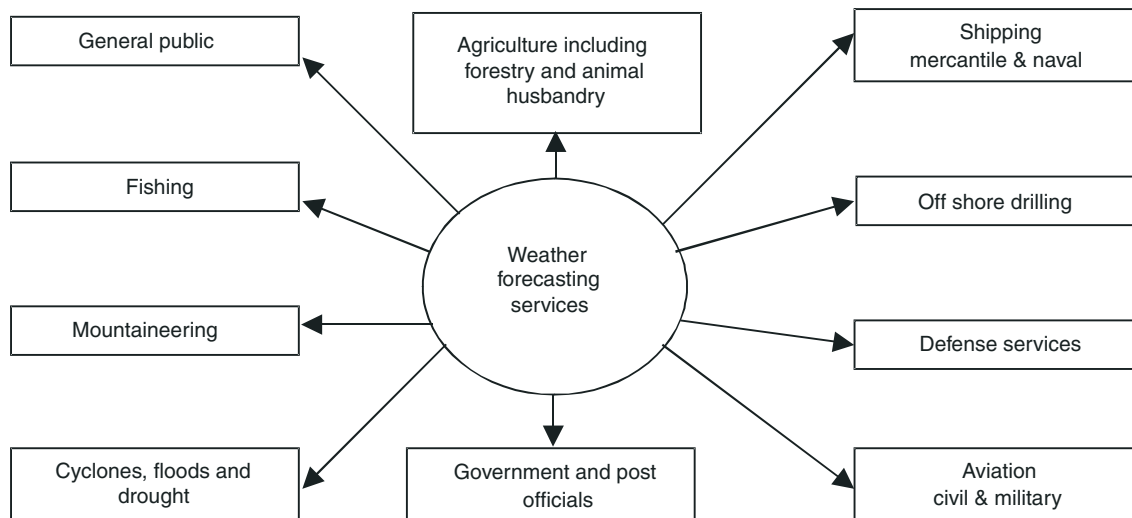

Fig. 4.3

A. Importance

Weather has many social and economic impacts in a place. Among different factors that influence crop production, weather plays a decisive role as aberrations in it (up to 50% variations in crop production). The rainfall is the most important among the required forecast, which decides the crop production in a region and ultimately the country's economy. The planning for moisture conservation under weak monsoon condition and for flood relief under strong monsoon condition is important in a region. A reliable weather forecasting when disseminated appropriately will pave way for the effective sustainability. One can minimize the damage, which may be caused directly or indirectly by unfavourable weather. The recurring crop losses can be minimized if reliable forecast on incidence of pest and diseases is given timely based on weather variables. It helps in holding the food grain prices in check through buffer stock operations. In good monsoon years when prices fall, the government may step in and buy, and in bad years when price tend to rise, the government may unload a part of what it had purchased. Judicious use of water can be planned in a region depending up on the forecast.

B. Type of Weather Forecast

There are three types of weather forecasting for agriculture.

1. **Short range forecast** - It is valid for 24–48 hours with 70–80% accuracy. Short range forecast gives emphasis on temperature, wind velocity and directions, duration of sunshine, time and amount of precipitation and relative humidity. It helps in scheduling irrigation, adjusting time of agricultural operations and protecting plants from frost.
2. **Extended forecast** - It is valid within 5 days with 60–70% accuracy. It gives emphasis on type of weather, sequence of rainy days, normal weather, sequence of rainy days, normal weather hazards in farming such as strong winds, extended dry or wet spells. This type of forecast helps to determine sowing time and depth of sowing; in planning of irrigation; in making decisions on harvesting and time of spraying to get higher efficiency and in managing labourers and equipments.
3. **Long range forecast** - It is valid up to 4 weeks to the season. It has emphasis in abnormality of temperature and precipitation. This forecast will be helpful in deciding soil moisture management, irrigation scheduling, selection of crops, managing irrigation with limited water supply and deciding cropping pattern and crop yield.

<i>Types of forecast</i>	<i>Validity period</i>	<i>Main users</i>	<i>Predictions</i>
1. Short range (a) Now casting (b) Very short range	Up to 72 hours 0-2 hours 0-12 hours	Farmers, marine agencies, general public	Rainfall distribution, heavy rainfall, heat and cold wave conditions, thunder storms etc.
2. Medium range	Beyond 3 days and up to 10 days	Farmers	Occurrence of rainfall, temperature.
3. Long range	Beyond 10 days up to a month and a season	Planners	This forecasting is provided for Indian monsoon rainfall. The out looks are usually expressed in the form of expected deviation from normal condition.

C. Usefulness of Weather Forecasting

Though the losses due to weather factors cannot be avoided completely, the losses could be minimized by making adjustment with weather through timely and accurate weather forecasting. The weather

forecasts also provide guidelines for long range seasonal planning and selection of crops suited to the anticipated climatic condition. By forecasting anticipated heavy rains,

- Irrigation from wells can be avoided by which we can save electricity.
- The harvesting could be advanced if the crop is in maturity stage.
- Threshing of harvested produce could be done before rains by which crop losses can be avoided.

Loss of seed, diesel, labourer and time can be avoided by not sowing in unsuitable weather. Fertilizer losses can be avoided by not applying during unsuitable weather condition for fertilizer application. Similarly pesticide wastage can also be minimized.

D. Weather Forecasting Organization

Suitable organizations have been set up in most parts of the World for weather forecasting. Accepted international norms for measuring weather elements and representing them in international code are being adopted by all the participating countries. There are about 300 meteorological observatories of different types, distributed all over India, for the purpose of forecasting. Recently, automatic weather stations for all regions are being installed in districts by ISRO.

E. Tools

Synoptic charts and crop weather calendar are the tools for making weather forecasts.

1. **Synoptic charts** - An enormous volume of meteorological data is being collected from all over the world continuously round the clock through various telecommunication channels. To assess, assimilate and analyze the vast data, they have to be suitably presented. For this purpose, the observations are plotted on maps in standard weather codes. These maps are called ‘Synoptic maps or charts’. Synoptic charts display the weather conditions at a specified time over a large geographical area. The surface synoptic charts plotted for different synoptic hours (00, 03, 06, 09, 12, 15, 18, 21 UTC) depict the distribution of pressure, temperature, dew point, clouds, winds, present and past weather. In place of GMT, UTC (Universal Time Co-ordinate) is used. The upper air charts are also prepared at the standard pressure levels of the atmosphere (different heights) of the atmosphere wherein the pressure, wind and temperature are plotted. The surface charts together with the upper air charts provide a composite three-dimensional weather picture pertaining to a given time. Thus, it gives a birds eye view of the state of atmosphere at a time over a large area and is a important tool used by operational meteorologists and scientists. The surface synoptic charts are the most used charts. It contains the maximum number of observations with the largest number of parameters plotted and often forms the base on which the pressure level charts are built up. The pattern of the pressure distribution is brought out by drawing isobars, troughs, ridges, lows, highs, depressions, cyclones, fronts and discontinuities. These systems are clearly marked and labelled using appropriate symbols and colours. In synoptic charts, different weather phenomena and atmospheric characters are marked with different symbols as mentioned below.

<i>S.No</i>	<i>Symbols</i>	<i>Weather element/character/phenomenon</i>
1.	Narrow black lines	Isobars
2.	Numbers at ends of isobars	Pressure values in hPa

(Contd.)

S.No	Symbols	Weather element/character/phenomenon
3.	Shading	Precipitation
4.	Arrows	Wind direction
5.	Feathers in the arrows	Wind velocity
6.	Small circles with shading	Amount of clouds

In addition to the above, different symbols are used for recording weather phenomena.

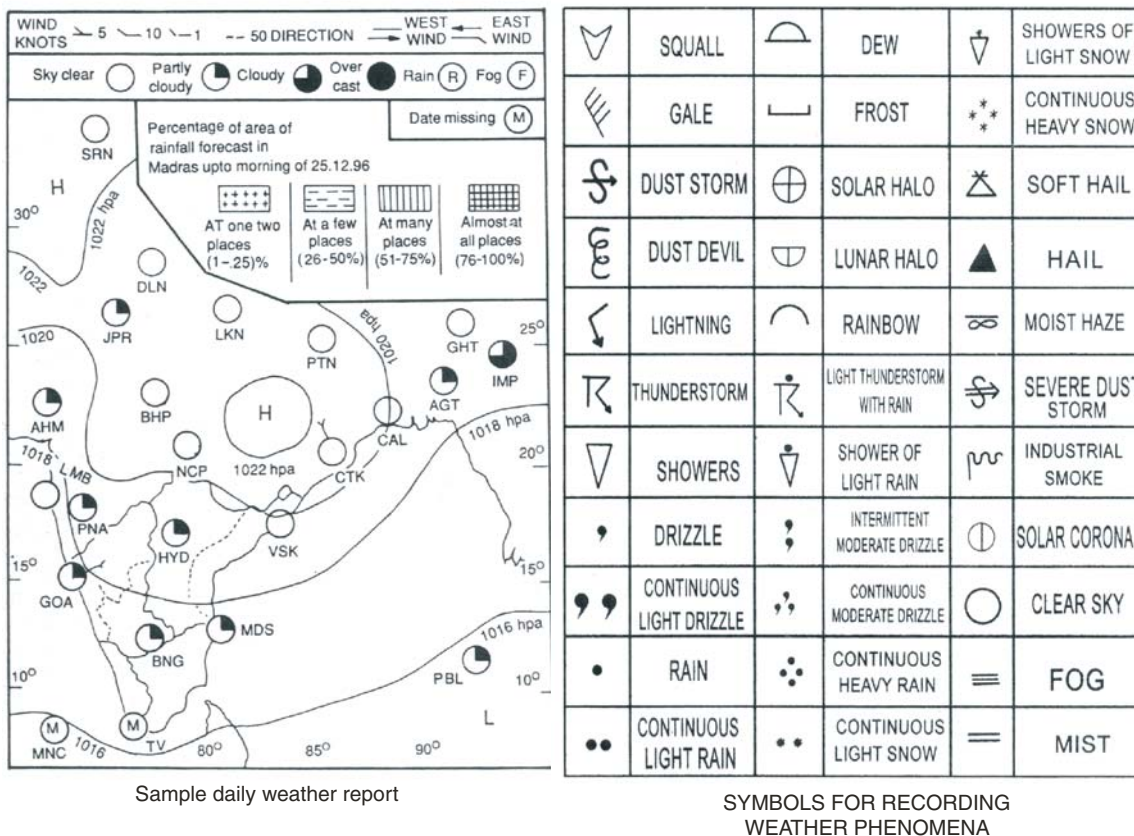

Fig. 4.3

2. **Weather calendar** - In order to provide the farmers with an efficient weather service, it is essential that the weather forecaster should be familiar with the crops that are grown in a particular agroclimatic zone. The type of forecast warnings to be given depends on the stages of the crop. The farmers should become familiar with weather bulletins and learn how to interpret. To meet the above requirement, the detailed information collected from the agricultural departments has been condensed by the IMD and presented in a pictorial form known as crop weather calendar. This calendar has three parts viz., (a) Bottom part, (b) Middle part, and (c) Top part.

(a) **Bottom part** provides the activities related to crop or information related to phenological stages of the crop and the months.

- (b) **Middle part** gives information regarding normal weather condition required for active crop growth. It is divided into different sections according to rainfall, rainy days, minimum and maximum temperature, pan evaporation and sunshine hours.
- (c) **Top part** gives information related to the weather abnormalities or to take precautionary measures. Top part is divided into different sections according to dry spell length, high wind, heavy rainfall and cloudy weather.

Table 4.4. Weather normals for Agricultural Crops

Sl. No.	Crops	Optimum temperature °C		Day length	Rainfall (mm)	Altitude above MSL (m)
		Germination	Growth stage			
1	Rice	<10°C	22-25 (flowering) 20-21 (grain formation) 20-25 (ripening)		1500	<3000
2	Maize		35-44°C			
3	Sorghum	7-10	25-30	Short day		
4	Pearl millet		28-32		400-750	
5	Finger millet				500-1000	
6	Kodo millet				400-500	
7	Wheat	20-22	16-22		250-1800	<3500
8	Barley		12-15 (growth) 30 (reproduction)	Long day	400-500	
9	Oats		15-25		380-1140	
10	Ground nut		27-30	24-27	500-1250	
11	Sesame		25-27	Short day	500-650	<1250
12	Castor		20-26	Long day	500-600	<3000
13	Sunflower		20-25		500-700	<2500
14	Rape seed and Mustard		18-25	Long day	300-400	
15	Safflower	15-16	25-30	Day neutral	600-900	
16	Soybean	15-32	30-33		600-650	1200-2000
17	Pigeon pea		20-30			
18	Green gram	15	20-40	Short day	600-1000	
19	Black gram					1500
20	Cow pea	12-15	21-35	Short day	600	
21	Bengal gram		15-25		600-1000	
22	Cotton	18	21-27	Day neutral	500	
23	Jute		27-40	Short day	1500	
24	Tobacco	28	25-35		500-1000	
25	Sugar cane		24-30	Long day	2000-2500	
26	Sugar beet	12-15	22-30	Long day		
27	Potato	18-20	18-20			

4.16 REMOTE SENSING (RS)

Remote sensing is defined as the art and science of gathering information about objects or areas from a distance without having physical contact with objects/areas being investigated.

Role of RS - Agricultural resources are important renewable dynamic natural resources. In India, agriculture sector alone sustains the livelihood of around 67% of the population. Increasing agricultural productivity has been the main concern since scope for increasing area for cultivation is rather limited. This demands judicious and optimal management of both land and water resources. Hence, comprehensive and reliable information on land use/cover, forest area, soils, geological information, extent of wastelands, agricultural crops, water resources (surface and underground) and hazards/natural calamities like drought and floods is required. Season-wise information on crops, their acreage, vigour and production enables the country to adopt suitable measures to meet shortages, if any, and implement proper support and procurement policies. Remote sensing systems, having capability of providing regular, synoptic, multi-temporal and multi-spectral coverage of the country, are playing an important role in providing such information. Many experiments have been carried out in developing techniques for extracting agriculture related information from ground borne, air borne and space borne data.

A. Principles of Remote Sensing

Every material on the earth absorbs and reflects the solar energy. In addition, they emit certain amount of internal energy. The absorbed, reflected and emitted energy is detected by remote sensing instruments or sensors, which are carried in aircraft or satellites. The detections are made by characteristic terms called “spectral signatures” and “images”. Remote sensing systems in common use, record radiation in the form of electromagnetic spectrum (sunlight), *i.e.*, visible range (0.4–0.7 nm), near infrared (0.7–1000 nm) and microwaves (1nm–0.8 nm). Artificial sources of illumination such as radars are also used.

B. Sensors Used in Remote Sensing

Photography: Photographic systems are the most commonly used sensing systems. The film records the energy reaching it at the exposure time in the visible and near infrared ranges of the spectrum. The photographic technique is used to identify soil types, plants grown, disease incidence and drainage patterns.

Line scan and related system: The system uses the visible and near infrared portion of the spectrum. In this system, a mirror is rotated parallel to the direction of the movement of the aircraft or satellite. The mirror reflects the radiation received on to a detector and the data is recorded. The multi spectral scanners have different channels for different colours of visible and IR portions. The IR sensors also record the thermal infrared radiation emitted by the earth proportional to the surface temperature. The infrared imagery is used to study the extent of vegetation, soil moisture, etc.

Microwave system: The microwave radiation emitted from earth’s surface in small quantities is used by microwave sensors in a wavelength of about 1 nm–1000 nm. The sensors record the microwave radiation through complex antennae. These are used in weather satellites. The active microwave systems are known as radars. Radars are used to study soil characters, plant condition, soil moisture and runoff slopes.

C. Remote Sensing Platforms

Three platforms are generally used for remote sensing techniques. They are ground based, air based and satellite based. Infrared thermometer, spectral radiometer, pilot balloons and radars are some of the ground-based remote sensing tools while aircrafts are air based remote sensing tools. Since the ground

based and air based platforms are very costly and have limited use, space based satellite technology has become handy for wider application of remote sensing techniques. The digital image processing, using powerful computers, is the key tool for analyzing and interpretation of remotely sensed data. The advantages of satellite remote sensing are:

- **Synoptic view** – Wide area can be covered by a single image/photo (One scene of Indian Remote Sensing Satellite IRS series cover about 148×178 sq. km area).
- **Receptivity** – We can get the data of any area repeatedly (IRS series cover the same area every 16-22 days).
- **Coverage** – Inaccessible areas like mountains, swampy areas and thick forests are easily covered.

Space based remote sensing is the process of obtaining information about the earth from the instruments mounted on the earth observation satellites (EOS). The satellites are subdivided into two classes and the types of satellite are as follows:

- (i) **Polar orbiting satellites** - These satellites operate at an altitude between 550 and 1,600 km along an inclined circular plane over the poles. These satellites are used for remote sensing purposes. LANDSAT (USA), SPOT (FRANCE), and IRS (INDIA) are some of the remote sensing satellites.
- (ii) **Geostationary satellite**- These satellites have orbits around the equator at an altitude of 36,000 km and move with the same speed as the earth, so as to view the same area on the earth continuously. They are used for telecommunication and weather forecasting purposes. INSAT series are launched from India for the above purposes. All these satellites have sensors on board operating in the visible and near infrared regions of the electromagnetic spectrum. INSAT-3A was launched on 10th April, 2003.

D. Application

Remote sensing techniques are used in agricultural and allied fields for the following reasons:

- For collection of basic data for monitoring crop growth
- For estimating the cropped area
- For forecasting the crop production
- For mapping of wastelands
- For drought monitoring and its assessment
- For flood mapping and damage assessment
- For land use/cover mapping and area under forest coverage
- For soil mapping
- For assessing soil moisture condition, irrigation, drainage
- For assessing outbreak of pest and disease
- For ground water exploration.

Areas of general application: (i) Agricultural land use mapping; (ii) Agricultural population distribution; (iii) Land use potential, and (iv) Soil and water resource surveys.

Areas of specific application: (i) Crop identification; (ii) Crop acreage, vigour and density; (iii) Crop growth rates and maturity; (iv) Yield estimation and forecasting; (v) Soil problems like salinity etc.; (vi) Soil moisture, water quality and irrigation effectiveness; (vii) Drought prediction; (viii) Insects, diseases and nematodes; (ix) Frost damage; (x) Storm and flood warning; (xi) Fire

surveillance and control; (xii) Water availability and location of canals; (xiii) dates of planting and harvesting and (xiv) Areas of fertilizer application and effect of fertilizers.

Application to range surveys

- Identification of forage species and their yield
- Delineation of forest types and condition of range
- Carrying capacity of ranges
- Soil fertility and soil erosion
- Identification of poisonous species
- Pest, disease and weed infestation
- Wild life inventory
- Fire surveillance.

Application of livestock surveys

- Population studies, distribution of animals
- Animal behaviour, health of animals
- Types of farm buildings.

E. RS in India

India, with the experience gained from its experimental remote sensing satellite missions BHASKARA-I (1979) and BHASKARA-II (1981), has now established satellite based operational remote sensing system in the country with the launch of Indian Remote Sensing Satellite IRS-IA in 1988, followed by IRS-IB (1992), IRS-IC (1995) and IRS-ID (1997). The Department of Space (DOS)/Indian Space Research Organization (ISRO) as the nodal agency for establishing an operation remote sensing system in the country initiated efforts in the early 1970s for assessing the potentials of remotely sensed data through several means. In order to meet the user requirement of remote sensing data analysis and interpretation, ISRO/DOS has set up a system to launch remote sensing satellites once in three or four years to maintain the continuity in data collection. The remote sensing and some of its related institutes are depicted.

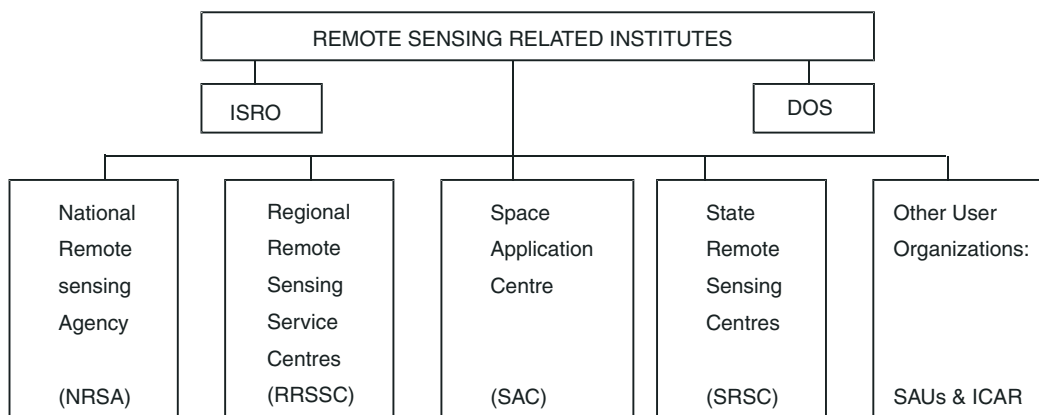

Fig. 4.5

In 1920, the first air survey using aerial photography was conducted.

In 1926, Aerial photography was used to assess flood situation.

In seventies, ISRO used remote sensing for resource inventory and launched Rohini-I (1981) and Rohini-II (1983).

F. Organizations using RS Techniques

- National Remote Sensing Agency (NRSA), Hyderabad
- Space Application Centre (SAC), Ahmedabad
- National Bureau of Soil Survey and Land Use Planning (NBSSLUP), Nagpur
- Central Ground Water Board (CGWB)
- National Institute of Oceanography (NIO)
- All India Soil and Land Use Survey (AISLS), New Delhi.

4.17 CROP WEATHER MODELING

Variations in crop yields between years are associated with many factors. This is mainly due to weather, soil and management factors. There is a complex reaction of weather variables among themselves as well as with other factors. Therefore, many attempts were made to study the effect of weather variables on crop yields through simulation modeling.

A. Model

Mathematical representation of a system is called as a Model. The process of developing such representation is termed as modeling. In a general term, a model brings into mind the thoughts about the form and functional form of real objects like children's toy, tailors dummies and make-ups of buildings and structure to be constructed later in the real forms. Models also construct the objects or situations not yet in existence in real form. A model can also be referred as a representation of relationship under consideration and may be defined as an act of mimicry.

B. Crop Model

It is a representation of a crop through mathematical equations explaining the crops interaction with both above ground and below ground environment. The increase in dry matter of the crop is referred to as growth. The rate of growth of a healthy crop depends on the rate at which radiation is intercepted by foliage and/or on the rate at which water and nutrients are captured by root systems and therefore, on the distribution of water and nutrients in the soil profile. The crop development is described in terms of various phenophases through which the crop completes its lifecycle. That is the progress of the crop from seeding or primordial initiation to maturity. Finally, the yield of crop stand is expressed as a product of three components *viz.*, the period over which dry matter is accumulated (the length of the growing period), the mean rate at which dry matter is accumulated and the fraction of dry matter treated as yield when the crop is harvested. It is understood that the crop growth, development and yield depend upon the mean daily temperature, the length of the day and the amount of solar radiation (PAR) received by the crop.

$$DTT = \frac{\text{Max. daily temperature} + \text{Min. daily temperature}}{2} - \text{Base temperature}$$

Where, DTT = Daily thermal time accumulation.

The time needed for the crop to reach a development stage depends upon temperature measured above a base value (DTT) and for photo periodically sensitive phases such as flowering, the day length above a fixed base. In the absence of stress, the harvest index does not vary much from year to year for a specified variety. Therefore, crop weather modeling is based on the principles that govern the

development of crop and its growing period based on temperature and/or day length. They are used to quantify the rate of crop growth in terms of radiation interception, water use and nutrient supply which moderate harvest index, when the crops experience stress condition.

The basic information required to be generated for crop weather modeling includes.

- Crop phenology in relation to the temperature and day length
- Water use by the crop during different phenophases of crop growth
- The relationship between radiation interception, crop water use and total dry matter production
- Partitioning of dry matter into various plant components as influenced by water and nutrient availability, and
- The effect of weather parameters on biotic interference to crop growth.

C. Types of Models

Simple statistical or Empirical statistical models - These models rely mainly on the statistical techniques such as correlation or regression of the appropriate plant and environmental variables. The regression co-efficient is not necessarily related to the important processes, but estimate the yield alone. Therefore, many studies are required to produce the regression equations necessary for the wide spread application of this kind of models. A great advantage of these simple crop weather models is that they use readily available weather data.

A model based on physiological and physical aspects - These are mechanistic models where plant and soil processes are described with respect to physiological or physical or chemical aspects. For example, N may be taken up from the soil by the root system depending on soil N content and rate of availability to the roots. Thus, physical place of N in the visibility of root system and transformation is important.

Phenological model - These models predict the crop development from one growth stage to another. The prediction is generally based on the accumulated heat limits.

Mechanistic model - These models explain not only the relationships between the weather parameters and the yield, but explain the relationship of influencing dependent variables.

Deterministic models - These models estimate the exact value of the yield or dependent variable and have defined co-efficient.

Stochastic models - A probability element is attached to each output. For each set of inputs different outputs are given along with probabilities. These models define the yield or state of dependent variable at a given rate.

Dynamic models - Time is included as a variable. Both dependent and independent variables are having values, which remain constant over a given period of time. Over a period of time, these variables are changing due to change in rate of increment.

Static models - Time is not included as a variable. The dependent and independent variables having values remain constant over a given period of time.

Dynamic crop simulation models - These models predict changes in crop status with time. As example, model, which predicts soil water content at a certain depth throughout the season, or the one, which predicts changing number of bolls on cotton with the season, are dynamic simulation models. Crop simulation model predicts the final yield and also provides quantitative information on intermediate steps like daily weight of different plant parts, which is verified through experimentation. The model acts like a real crop be gradually growing leaves, stems, roots etc., during a season.

In other words, simulation is the process of using a model dynamically by following a system over a time period. A dynamic crop simulation model is most successfully developed by a multi-disciplinary

team consisting of agro-meteorologists, agricultural engineers and plant physiologists. Computer models in general, are a mathematical representation of a real world system. One of the main goals of crop simulation models is to estimate agricultural production as a function of weather and soil conditions as well as crop management. These models use one or more sets of differential equations over time, normally from planting until harvest maturity or final harvest.

Descriptive models - A descriptive model defines the behaviour of a system in a simple manner. The model reflects little or none of the mechanisms that are the causes of phenomena but consists of one or more mathematical equations. An example of such an equation is the one derived from successively measured weights quickly the weight of the crop where no observation was made.

Explanatory models - This model consists of quantitative description of the mechanisms and process that cause the behaviour of the system. To create this model, a system is analyzed and its process and mechanisms are quantified separately. The model is built by integrating these descriptions for the entire system. It contains descriptions of distinct processes such as leaf area expansion, tiller production etc. Crop growth is a consequence of these processes.

D. Uses of Crop Weather Modeling

The models can be used as a research tool in planning alternative strategies for cropping, land and water management practices for a range of agro-climatic conditions. It will be helpful for economists to work out cost benefit ratio analysis. It enables plant breeder to develop crop varieties tailored to different agro-climatic conditions. It helps in making appropriate management decision for production and in identifying most potential area for research.

E. Advantages of Crop Weather Modeling

Modeling relates plant growth and development from seedling to maturity. The variability of growth and development is understood by basic concepts explained on mathematical basis. The response of plants to their macro and microenvironments are quantified. It provides an understanding of the development process in plants and also helps in knowing missing data to have complete picture of the processes. It will give new ideas leading to experimental approaches. Modeling enables the researchers to understand the effect of single factor and combination of several factors in one experiment. As such separate adhoc experiments can be avoided. Models will indicate priorities for applied research and will help managers in making suitable decisions.

4.18 CLIMATE CHANGE AND VARIABILITY

A. Climate Change

Any permanent change in weather phenomena from the normal of a long period average is referred as climate change *e.g.*, the global temperature has increased by 2.0–3.0°C and increase in CO₂ from 180 ppm to 350 ppm. The earth's atmosphere has never been free of change (in its composition, temperature, self-cleaning ability). Due to change in atmosphere, the world is warming, climatic zones are shifting; glaciers are melting and sea level is rising.

B. Climate Variability

The temporal changes in weather phenomena, which is part of general circulation of atmosphere and occurs on a yearly basis on a global scale.

Climate change and climate variability are the concern of human kind in recent decades all over the world. The recurrent drought and desertification seriously threaten the livelihood of over 1–2 billion

people who depend on the land for most of their needs. The weather related disasters *viz.* drought and floods, ice storms, dust storms, land slides, thunder clouds associated with lightening and forest fires are uncommon over one or other region of the world. The year 1998 was one of the recent weather related disaster year, which caused hurricane house in Central America and floods in China, India and Bangladesh. Canada and New England in the U.S. suffered heavily due to ice storm in January while Turkey, Argentina and Paraguay with floods in June 1998. Vast fires in Siberia burned over three million acres of forests. Human and crop losses are the worst phenomena in such weather disasters, affecting global economy to a considerable extent. In 2004, nobody can forget the Tsunami problem in Indonesia, India, Sri Lanka and other Asian countries.

The 1997-98 El-Nino events, the strongest of the last century is estimated to have affected 110 million people and cost the global economy nearly US \$ 100 billion. Statistics compiled from insurance companies for the period 1950-1999 show that major natural catastrophes that are mainly weather and climate related caused estimated economic losses of US \$ 960 billion. Most of the losses were recorded in recent decades. Increase in aerosols due to emission of green house gases including black carbon and chlorofluorocarbons (CFCS), ozone depletion, UV-B filtered radiation, cold and heat waves, global cooling and warming and “human hand” in the form of deforestation and loss of wetlands in the process of imbalanced development for betterment of human kind may be caused factors for climate variability and climate change.

C. Causes of Climatic Variability

External causes

- **Solar output:** An increase in solar output by 0.3% when compared to 1650–1700 A.D. data.
- **Orbital variation:** 1. Earth orbit varies form almost a complete circle to marked ellipse (Eccentricity). 2. Wobble of earth’s axis (Precession of equinox) 3. Tilt of the earth’s axis of rotation relative to the plane of the orbit varies between 21.8° and 24.4°.

Internal causes

- Changes in the atmospheric composition—change in the green house gases especially CO₂
- Land surface changes particularly the afforestation and deforestation
- The internal dynamics of southern oscillation—changes in the sea surface temperature in western Tropical Pacific (El-Nino/La-Nina) coupled with Southern Oscillation Index, the Tahiti minus Darwin normalized pressure index leading to the ENSO phenomena
- Anthropogenic causes of climate variation in green house gases and aerosols.

D. Effects of Climate Change

The increase in concentration of CO₂ and other green house gases are expected to increase the temperature of the earth. Crop production is weather dependant and any change will have major effects on crop production and productivity. Elevated CO₂ and temperature affects the biological process like respiration, photosynthesis, plant growth, reproduction, water use etc. Depending on the latitude, the CO₂ may either offer beneficial effect or may behave otherwise also.

1. **Greenhouse effect** - The theory of “greenhouse effects” was conceived by J.B. Fourler over a century ago. It was supported by Tyndall’s studies on the absorption of heat by gases. The Swedish Svante-Arrhenius had calculated in 1896 that there would be a global warming by 3.2-4.0°C due to doubling of CO₂ concentration in the atmosphere. This level could be attained sometime in the next century, due to large industrial emissions and large population, which has changed the land and increased the use of fossil fuels. Some gases change the heating rates in

the atmosphere. Like one way filter, they allow the energy from sun to pass through them, but trap the heat that the earths surface sends back. This is similar to what occur in a green house, where the glass on the roof is transparent to solar radiation but absorbs long wave radiation. Due to this analogy the term “green house effect” has been given. Increased human activities increase carbon dioxide, methane, nitrous oxide, chlorofluorocarbons (CFC) etc., which lead to increase in temperature and sea level rise. These gases, which are in traces, cause environmental perturbations (disturbances) such as green house effect (global warming), stratospheric ozone depletion, acid deposition, smog and corrosion.

<i>Environmental perturbations</i>	<i>Responsible gases</i>
Green house effect	CO ₂ , CH ₄ , Methane, N ₂ , CFCS, Ozone
Ozone depletion in the stratosphere	Chlorofluorocarbons (CFCS)
Acid deposition	SO ₂ , NO, NO ₂ , S, O ₃
Smog corrosion	SO ₂

Impacts of Green House Effect

(i) Global warming, and (ii) sea level rise

The green house effect will disturb the climate by changing rainfall, wind, cloud, ocean currents and the extent of polar ice caps. The global impact of these changes could be very large.

The first issue and the cause of some major problems in the future, the depletion of the ozone layer, threatens the inhabitants of Earth due to the advent of harmful ultraviolet radiation. The second issue, global warming and the plight of Antarctica, involves the melting of polar ice caps threatening our coastal regions in the future. The third issue, electric cars, may or may not be the solution to major environmental problems 50 years in the future. We hope that by exploring our website, you will be enlightened about these three issues concerning the future of our planet in the year 2050.

The depletion of the Ozone layer - The ozone is a thin layer of atmosphere that protects us from the sun. It wraps all the way around the Earth, about 10 to 30 miles straight up. From the beginning of time, the ozone has blocked the sun’s most dangerous ultraviolet rays from reaching us. It continues to do so even today. Each ozone molecule is made up of three small oxygen atoms that act like a safety net to catch most of the UV rays and keep them from getting down to the Earth’s surface. There’s been a problem in the last few decades though. The ozone layer is being depleted with the higher usage of products that emit chlorofluorocarbons, or CFC’s. Right now, only a small region of Antarctica is actually covered by ozone because such a large hole is forming over the area. The ozone layer is thinning even over more heavily populated areas like North America and Australia.

What Depletes the Ozone Layer?

The depletion of ozone is caused by the release of chlorofluorocarbons (CFCs) and other ozone-depleting substances (ODS). Some common ODS are refrigerants, insulating foams, and solvents. The following focuses mostly on CFCs, but is relevant to all ODS. Although CFCs are heavier than air, they are eventually carried into the stratosphere in a process that can take as long as 2 to 5 years. Measurements of CFCs in the stratosphere are made with the help of balloons, aircraft, and satellites. When CFCs reach the stratosphere, the ultraviolet radiation from the sun causes them to break apart and release chlorine atoms which react with ozone, starting chemical cycles of ozone destruction that deplete the ozone layer. One chlorine atom can break apart more than 100,000 ozone molecules.

Other chemicals that damage the ozone layer include methyl bromide (a pesticide), halons (used in fire extinguishers), and methyl chloroform (a solvent used in industrial processes). As methyl bromide and halons are broken apart, they release bromine atoms, which are 40 times more destructive to ozone molecules than chlorine atoms. CFCs and other ODS are heavier than air. In a still room, they would pool on the floor, but the atmosphere certainly not still. Numerous measurements have proven that these molecules are mixed nearly uniformly throughout all the troposphere over the entire earth. In the same way that vinegar and oil normally separate when still, but mix when shaken, ozone depleting substances and air are thoroughly stirred together by winds in the troposphere.

Global Warming: Problems for Antarctica

This heating of the earth might cause many problems in the future if not stopped. The higher temperatures will melt the polar ice caps, and that means that the sea level will increase. The sea level has already risen around 4 to 10 inches in the past 100 years. A higher sea level might wash out beaches all over the world and inundate seaside cities and towns that are at or below sea level.

1. **Preventing global warming** - There are things that we as people in society can do to prevent further global warming. We can try to emit the least possible amounts of greenhouse gases. We can do this by carpooling, using more efficient cars or electrical cars, not purchasing aerosol products and by getting our air conditioners serviced annually. Another simple way to help is to turn off electrical appliances when they are not being use. This will reduce the amount of electricity being consumed and allow power plants to reduce the amount of fossil fuels being burned. The burning of fossil fuels release enormous amounts of carbon dioxide into the atmosphere. Plants, on the other hand, use carbon dioxide for photosynthesis so the more plants and trees we plant, the less carbon dioxide in the atmosphere. One acre of lawn removes one ton of carbon dioxide, nitrous oxide and other air pollutants in one year. The problem is that many rainforests are being razed to make way for cattle grazing and cows are one of the largest sources of methane. Other forests are being burned down (which by itself creates more carbon dioxide) to make room for the increasing population. We must control the population explosion as well to prevent more global warming. The more aware every individual is, the more will be contributed to stopping the increase of global warming. If we try to reduce the greenhouse gases being emitted, we can save Antarctica and prevent other disasters and changes of temperature that will affect the coastal regions and the rest of the environment.
2. **EL Nino and La-Nina** - El-Nino is a Spanish word meaning “the boy child” (‘Child Christ’) because El-Nino occurs around Christmas time each year when the water of the Peruvian coast warm slightly. In every 3–6 years, the water becomes unusually warm. ‘El Niño’ is now used more widely to refer to this abnormal warming of the ocean and the resulting effects on weather. ‘El Niño’ is often coupled with ‘Southern Oscillation’ as the acronym ENSO. ‘La Niña’ is used popularly to signify the opposite of El Niño, occurring when the waters of the eastern Pacific are abnormally cold. La Niña episodes are associated with more rainfall over eastern Australia, and continuing drought in Peru. Peruvian meteorologists have objected to term La Niña-the Girl Child-because Christ is not known to have had a sister, and the term anti-ENSO is sometimes preferred.

The El-Nino event is due to decrease in atmospheric pressure over the South East Pacific Ocean. At the same time, the atmospheric pressure over Indonesia and North Australia increases. Once the El-Nino event is over, the atmospheric pressure over the above regions swings back. This sea-saw pattern of atmospheric pressure is called Southern Oscillation. Since El-Nino and Southern Oscillation

are linked they often termed as ENSO. It is most important one, which represents a tendency for high atmospheric pressure over the Pacific Ocean, represents to be associated with low pressure over the Indian Ocean and vice-versa. A measure of the monsoon low pressure is the Southern Oscillation Index (SOI) represented by the difference in sea level pressure over Tahiti, an Island in South central Pacific and Darwin in North Australia, which represents the northern part of the Indian Ocean. The positive SOI denotes high pressure over the central Pacific and low over Indonesia, North Australia and Northern Indian Ocean. Above average rainfall is expected over India and Indonesia and North Australia if the SOI is positive. Drought or deficit rainfall is expected in the above countries if the SOI is negative, indicating high atmospheric pressure over Indonesia and low in the central Pacific.

Sir Gilbert Walker 1920, discovered there is a see-saw pattern in the atmospheric pressure between the Pacific ocean and Indian ocean. Where the pressure was high over the Southern Pacific, it was low over the Indian ocean, but once in every few years, the pressure pattern was reversed, that is, the pressures over the Indian ocean became high, while lower pressures prevailed over Southern Pacific. Sir Gilbert called it the Southern Oscillation, Dr. Bjerknes 1958–59 who found that the Southern Oscillation was closely linked to the sudden appearance of warm waters off coastal Peru in South America—due to rise in sea surface temperature. This abnormal warming of sea surface in off the coast of Peru and equator is called El Niño, which is highly related, with Southern Oscillations and these two phenomenon are collectively called ENSO. It has highly variable effect on global and Indian weather. EL-Niño (warm phase) event has a negative correlation with Indian SWM rainfall, while positive association with NEM rainfall in extreme peninsular India.

Towards the end of 1972 as series of catastrophic events in different parts of the world drew attention to their possibility of global teleconnection in weather, the monsoon off 1972 was poor-severe drought in Northern Africa. Around the same period of this are abnormal current of warm waters off the coast of Peru in the Eastern Pacific separately developed the fishing industry of the South America. EL-Niño is associated with poor or indifferent monsoon. Out of 24 warm phase EL-Niño years, only 6 years recorded more widely the average rainfall. La-Niña refers the cold event, sudden reduction in the sea surface temperature in the Pacific ocean causes the change in Indian winter monsoon, Selvaraju *et al.*, (1998) showed that when La-niña event occurs (cold event), the winter monsoon rainfall is going to be below normal. In the 11 out of 16 years, where La-niña occurs (cold phase) the NEM rainfall of Coimbatore was found to be below normal.

In general, soil is defined as the more or less loose and crumbly part of the outer earth crust. It is a natural dynamic body of mineral and organic constituents, differentiated into horizons, which differs among themselves as well as from the underlying parent material in morphology, physical make-up, chemical composition and biological characteristics. It is made up of small particles of different sizes. Soil is a three-dimensional body, which supports plant establishment and growth and it is a natural and dynamic medium. For a farmer, soil refers to the cultivated top layer (surface soil) only, that is, up to 15–18 cm of the plough depth. Soils widely vary in their characteristics and properties. Understanding the properties of soils is important (1) for optimum use they can be put to and (2) for best management requirements for their efficient and productive use.

Functions of soil

- It provides place and anchorage for plant growth and development.
- It serves as a medium for air and water circulation.
- It acts as a reservoir for water and nutrients.
- It provides space for beneficial microorganisms.

Pedology - The origin of the soil, its classification and its description are involved in pedology. Pedologist considers soil as a natural body and does not focus primarily on the soil's immediate practical utilization. Pedologist studies, examines and classifies soil as they occur in their natural environment.

Edaphology - It is the study of soils from the standpoint of higher plants. It considers various properties of soil as they relate to plant production. The edaphologist is practical, having the production of food and fibre as an ultimate goal. Simultaneously, the edaphologist must be a scientist to determine the reasons for variations in the soil productivity, and to find means of conserving and improving soil productivity.

5.1 SOIL PHASES

Soil is a complex system, made of solid, liquid and gaseous materials. Soil is a three phase or polyphasic system comprising of (a) solid phase, (b) liquid phase, and (c) gaseous phase in some proportions. Normally the proportion is 50:25:25, but this may vary from soil to soil. In some occasions, liquid or gaseous phase may be absent. For *e.g.*, in water logged soil, air is not present; similarly in desert dry sandy soils, water is not present.

Components of Soil

Soil consists of four major components. They are: (i) Mineral matter, (ii) Organic matter, (iii) water, and (iv) air. Physically, soil consists of stones, large pebbles, dead plant twigs, roots, leaves and other parts of the plant, fine sand, silt, clay and humus derived from the decomposition of organic matter. In the organic matter portion of the soil, about half of the organic matter comprised of the dead remains of the soil life in all stages of decomposition and the remaining half of the organic matter in the soil is alive. The living part of the organic matter consists of plant roots, bacteria, earthworms, algae, fungi, nematodes actinomycetes and many other living organisms.

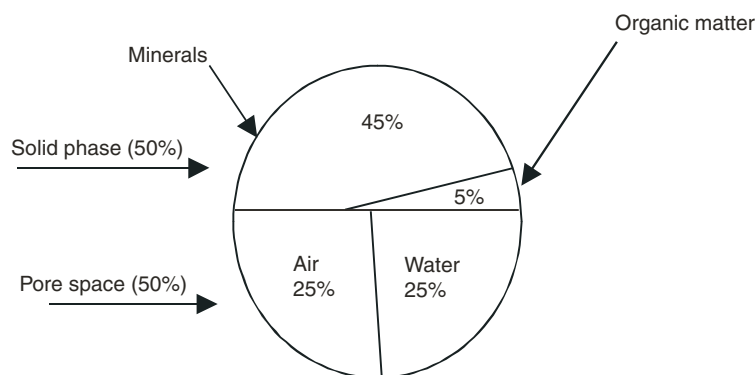

Fig. 5.1

Soil contains about 50% solid space and 50% pore space. Mineral matter and organic matter occupy the total solid space of the soil by about 45% and 5% respectively. The total pore space of the soil is occupied and shared by air and water on roughly equal basis. The proportion of air and water will vary depending upon the weather and environmental factors.

(a) **Soil mineral matter (SMM)** - Size and composition of mineral matter in soils are variable due to nature of parent rock from which it has been derived. The rock fragments are disintegrated and broken portion of the massive rocks, from which regolith through weathering, the soil has been formed. These materials are usually very coarse and the minerals are extremely variable in size. The primary minerals *viz.*, quartz, biotite, muscovite (dominates coarse fractions of the soil) and the secondary minerals *viz.*, silicate clays and hydrous oxides clays of iron and aluminium (as very fine fraction) are present.

(b) **Soil organic matter (SOM)** - Soil organic matter exists as partly decayed and partially resynthesized plant and animal residues. These are continuously being broken down as a result of microbial activity in soil. Due to constant change, it must be replenished to maintain soil productivity. The organic matter content in a soil is very small and varies from only about 3–5% by weight in topsoil. In addition to partly decayed plant and animal residues, soil organic matter contains living and dead microbial cells, microbiologically synthesized compounds and derivatives.

Importance

- Organic matter is a storehouse of nutrients in soil. It is responsible to get the most desirable soil structure.
- It promotes greater proportion of large pore sizes, improves water holding capacity and aeration status of soil.

- It is a main source of N, 5-6% of P, and 80% of S. It also supplies different trace elements like boron, molybdenum etc.
- It acts as a chelate, due to chelate formation between organic matter and various metals; the availability of these metallic elements will be increased.
- It contributes to cation exchange capacity in soils.
- It reduces soil erosion; shades the soil and keeps the soil cooler.

(c) **Soil water** - Soil water plays a very significant role in soil-plant growth relationship. Water is held within the soil pores with varying degree of forces depending upon the amount of water present. With the increasing amount of water in soil, the forces of retention of water by the soil will be low and vice-versa. The movement and retention of water in the soil is primarily influenced by the characteristics of the soil *viz.*, texture, nature of inorganic and organic colloids, type and amount of exchangeable cations, size and total amount of pore spaces etc. Water held by soil with high force of attraction is not available to the plants. Soil water along with dissolved salts makes up the soil solution. These soil solution acts as an important medium for supplying different nutrient elements through exchange phenomena between soil solid surface and soil solution and the plant roots.

(d) **Soil air** - Pore spaces in soil consist of that portion of the soil volume not occupied by soil solids, either mineral or organic. Under field condition, pore spaces are occupied by air and water; the more the water the less the room for air and vice-versa. The relative amounts of air and water in the pore space fluctuate continuously. During rainy season, water replaces air from the soil pore spaces, but as soon as water leaves by downward movement, surface evaporation, and transpiration etc., air gradually replaces the water, as it is lost from the pore spaces. Soil air contains various gases like CO₂, very small amounts of O₂ and N etc. Generally, soil air contains much more CO₂ and small amount of O₂ than that of atmospheric air due to microbial respiration when large amounts of CO₂ releases into the air and O₂ is taken up by soil microorganisms. Well-aggregated soil having large pore spaces offers less mechanical impedance to root developments and shoot emergence and do not form crusts easily. Good aeration occurs in well-drained soils, which have sufficient proportion of their volume occupied by pores. Cultural practices affect soil aeration and plant growth through modification of different soil physical properties like bulk density, porosity, aggregation etc. Soil air also influences beneficial microorganisms in soil.

5.1.1 Solid Phase

The solid phase is made of minerals, organic matter and various chemical compounds.

- Mineral** - The mineral particles are the chief components of most soils. They consist of remains of parent rock and particles developed *in situ* by weathering or deposited in bulk by wind or water force. The proportion and sizes of these particles determines the soil texture.
- Organic matter** - The organic fraction consists of both plant and animal matter in two phases either alive or in different stages of decomposition as discussed above. It varies from 1-5% by weight in different soils. Normally in tropics, red soil contains less than 1% and heavy soil up to 2%.
- Chemical compounds** - The chemical components of soils are made of silica and silicates. It varies from profile to profile; generally the larger particles contain more silica content and finer particles contain more of potassium, calcium and phosphorus. The dominant minerals are quartz in sand, quartz and feldspars in fine sand and silt, vermiculite, montmorillonite, kaolinite and amorphous colloids in clay. Oxides, carbonates and sulphates are the other common minerals present in the soil.

5.1.2 Liquid Phase

The liquid phase of soil consists of water, dissolved minerals and soluble organic matter. This is known as soil water, which is stored in the space between soil particles known as pore space. This pore space is the most important physical structure and plays a vital role in irrigation studies. Plants absorb water from the pore spaces and hence this water must be replenished by rain or irrigation water for the successful growth of crops. Hence, the soil serves as a reservoir for moisture.

5.1.3 Gaseous Phase

The spaces in between soil particles are not only filled with water, but some spaces are occupied with air. The soil air differs from atmospheric air in its composition. Soil air contains less O_2 content and more CO_2 than atmospheric air, because of the respiration of soil microorganisms and plant roots in which oxygen is consumed and carbon dioxide is released. So, the pore spaces enclosed by soil matrix are shared by soil-air and soil-water. As the amount of one increases, that of the other decreases.

Table 5.1. Composition of Soil and Atmospheric Air (%)

<i>Air</i>	O_2	CO_2	N_2
Soil air	20.05	0.25	79.20
Atmospheric air	20.97	0.03	78.03

5.2 PROPERTIES OF SOIL

5.2.1 Physical Properties of Soil

5.2.1.1 Soil Texture

It refers to the nature of distribution of particles of various sizes present in the soil. It is the proportion of coarse, medium and fine particles, which are termed as sand, silt and clay respectively. Hence, it can be defined as the proportion of sand, silt and clay particles in soil. The mineral soil particles are classified according to their sizes.

I. Textural classification based on size of soil particles (USDA)

<i>Particle diameter</i>	<i>Classified as</i>
< 0.002 mm	Clay
0.002 - 0.05 mm	silt
0.05 - 0.10 mm	very fine sand
0.10 - 0.25 mm	fine sand
0.25 - 0.50 mm	medium sand
0.50 - 1.00 mm	coarse sand
1.00 - 2.00 mm	very coarse and
>2.00 mm	gravel

This is simply classified into four groups as follows

< 0.002 mm	– Clay
0.002 to 0.05 mm	– silt
0.05 to 2 mm	– sand
> 2 mm	– gravel

II. International Society of Soil Science-ISSS (Atterberg, 1922)

> 2 mm	gravel
2-0.2 mm	coarse sand
0.2-0.02 mm	fine sand
0.02-0.002 mm	silt
<0.002 mm	clay

III. United States Department of Agriculture (USDA)

Gravel	> 2 mm
Very coarse sand	2-1 mm
Coarse sand	1-0.5 mm
Medium sand	0.5-0.25 mm
Fine sand	0.25-0.1 mm
Very fine sand	0.1-0.05 mm
Silt	0.05-0-0.002 mm
Clay	< 0.002 mm

Out of these systems, the textural classification based on size of soil particles is commonly followed in India. Based on the proportion of sand, silt and clay particles, classification was made and standardized into twelve classes as shown in a triangular diagram. This triangle is known as USDA (United States Department of Agriculture) soil textural classification triangle. The twelve classes are as follows.

1. Sand, 2. Silt, 3. Clay, 4. Loam Sandy, 5. Clay silty, 6. Clay, 7. Clay-loam 8. Loamy sand, 9. Sandy loam, 10. Silty loam, 11. Sandy clay loam, and 12. Silty clay loam. For example, in a soil sample if the silt percentage is 20, sand percentage is 50 and clay percentage is 30, then these proportions are intersecting at sandy clay loam.

USDA Soil Textural Triangle

A. Soil texture

- (a) **Sand** - It contains < 50% clay and silt, and at least 70% of sand. Coarse, highly porous, large volume of non-capillary pore space, easy drainage, free air circulation, rapid decomposition of organic matter due to free air circulation, low water holding capacity, low nutrient content, low CEC, frequent irrigation requirement and easiness for workability of implements are the characteristic features of sandy soil.

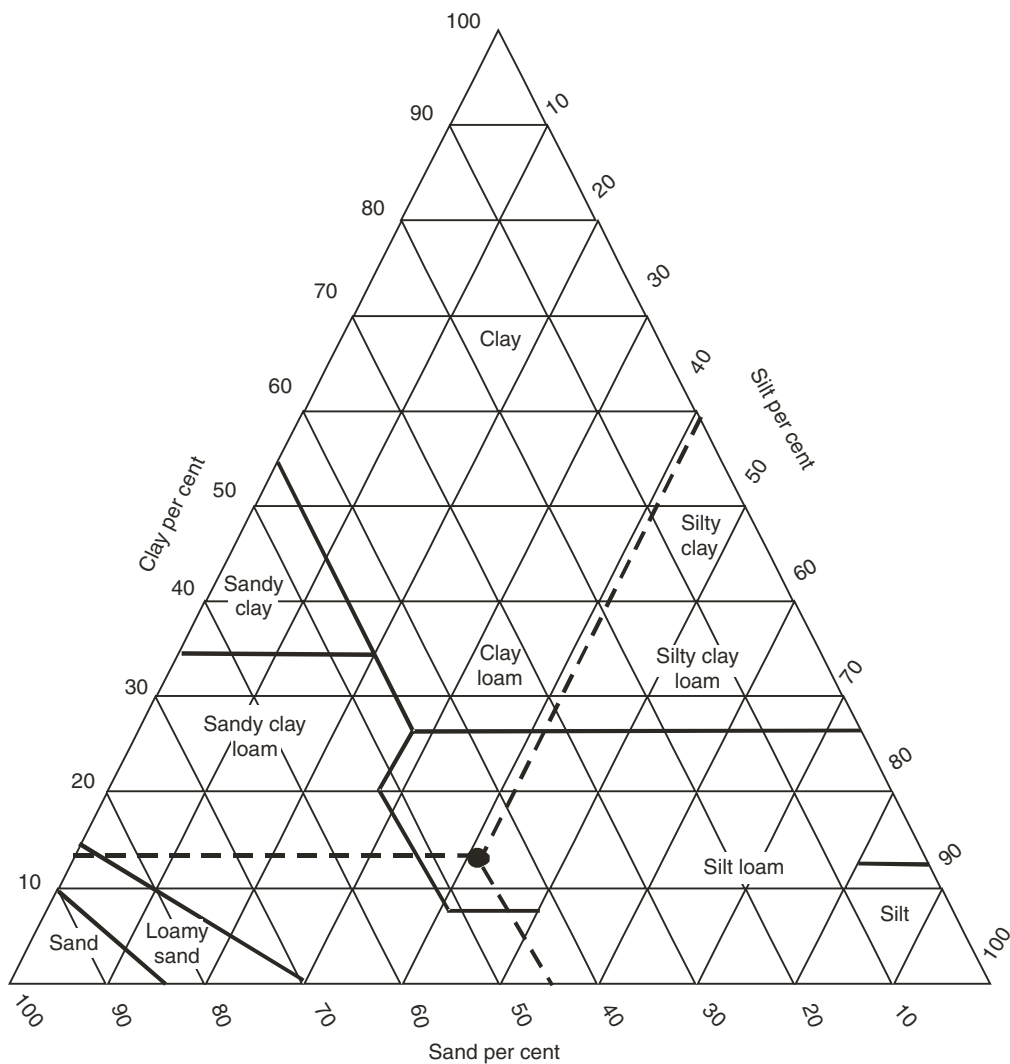

Fig. 5.2

- (b) **Clay** - It contains >45% of clay and 45% of sand or silt. Minute fine particles, large internal surface area, more active both chemically and biologically, sticky when wet and hard when dry, high water holding capacity (WHC), relatively high nutrient holding capacity, slow movement of water and air, hardier for workability of implements and slow release of water to plants with poor drainage are its important features.
- (c) **Silt** - It contains 80% silt and less than 12% of clay. Medium in all the above said characteristics discussed in sand and clay.
- (d) **Loam** - It contains equal amount of sand, clay and silt. These soils are considered better for plant growth.

Table 5.1. General terms to describe Soil Texture in relation to Soil Textural Class Names

<i>Common names</i>	<i>Texture</i>	<i>Basic soil textural class</i>
Sandy soils	Coarse	Sands Loamy sands Sandy loam Loam
Loamy soils	Medium	Silt loam Silt Sandy clay loam Silty clay loam Clay loam
Clayey soils	Fine	Sandy clay Silty clay Clay

B. Importance in irrigation management

It plays a vital role in permeability of water and water movement, gaseous exchange capacity, root growth, water holding capacity of soil and water supplying capacity to the plants. All the above functions are determined by the predominant soil particles *viz.*, sand, silt and clay.

- (i) **Stones and gravel** - If stones and gravels are present < 10 percent, it reduces evaporation, facilitates good drainage, and results in easiness for the workability of tillage and inter-cultural implements. If stones and gravels are present > 10 percent, Soil will be too open and loose; It permits rapid drainage; It reduces soil water retention capacity and Indirectly it leaches the soil nutrients.
- (ii) **Sand** - If sand particles are about 40 percent, the soil will be open and friable which favours optimum retention capacity of soil water, optimum gaseous exchange and optimum drainage. If sand particles are > 40%, it causes rapid evaporation, excess drainage and percolation and poor water holding capacity.
- (iii) **Silt** - If silt content is 30–40 percent, it provides a good loamy condition, which favours optimum water holding capacity and optimum drainage. If silt content is > 40%, it causes poor drainage.
- (iv) **Clay** - The clay content should be < 50% for irrigated crops. If clay content is more than this, it will lead to poor drainage and stagnation of water, poor gaseous exchange and high water holding capacity.

5.2.1.2 Soil Structure

It is defined as the shape and arrangement of soil particles with respect to each other in a soil mass or block. The soil aggregates are not solids but possess a porous or spongy character. Most soils are having a mixture of single grain structure or aggregate structure. The number of primary particles (sand, silt and clay) is combined together by the binding effect of organic and inorganic soil colloids. The binding or cementing materials are: Iron or Aluminium Hydroxide and decomposing organic matter. The names of soil structures based on their shapes are: 1. Platy, 2. Prismatic, 3. Columnar, 4. Blocky, 5. Cloddy, 6. Granular, 7. Crumb, 8. Single grain, and 9. Massive.

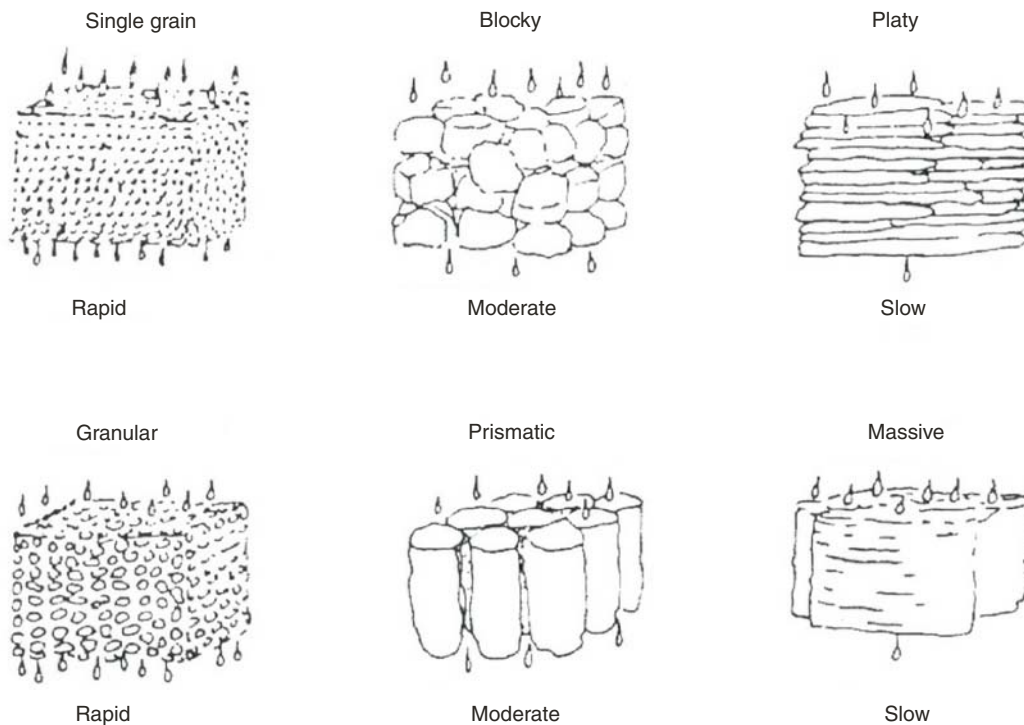

Fig. 5.3

Different types of soil structures - Soil structure is described under three categories *viz.*, 1. Type, 2. Classes, and 3. Grades.

I. Type: Depending upon the presence or absence of interconnection between soil pores the aggregates are divided into two groups. Each group is further subdivided into two sub groups depending upon the regularity of the size and shapes of the pores. Each sub group is named as under.

(i) Pores interconnected

- (a) Spongy, if pores are irregular in shape and size
- (b) Cellular, if pores are regular in shape and size

(ii) Pores not interconnected

- (a) Vesicular, if pores and cavities are small, round and smooth inside.
- (b) Tubular, if pores and cavities are regular in size and connected to form tubes.

2. The classification is based on the shape, size and other physical features of soil aggregates. The aggregates are first classified into four groups according to main shape of aggregates or fragments.

(i) Plate like (ii) Prism like (iii) Block like (iv) Spheroidal.

- (i) **Plate like** - The horizontal dimensions are much more developed than the vertical axis resulting a flattened compressed or lens like appearance. When the units are thick, they are called platy. When the units are thin, they are called laminar. The platy is often inherited from the parent

materials. In addition, frost, fluctuating water table, compaction and this layering of different textured alluvium or lacustrine can form platy type of soil structure.

- (ii) **Prism like** - The vertical axis is more developed than others, with flattened sides, giving and pillar like shape. It has also two sub types. Columnar—when the top of such ped is rounded and prismatic—when the top of the prisms are plane, level and clean cut. The prism like structure are commonly found in sub soil horizons in arid and semi arid regions.
- (iii) **Block like** - All three dimensions are about the same size and the peds are cube like with flat rounded faces. Block like structure has also two sub types: angular blocky—when the faces are flat and edges of the cubes are sharp angular and sub-angular blocky—when the faces and edges are mainly rounded. The block like soil structures are usually found in the sub-surface horizons and their other characteristics have much to do with soil drainage aeration and root penetration.
- (iv) **Spheroidal** - All axes are developed equally with the same length, curved and irregular faces. All rounded or sphere like peds may be placed in this type of soil structure. This type has two structural sub types (a) granular simply the aggregates of this type are usually termed as granular and it is less porous, and (b) crumb, when the granules are especially porous.

II. Classes of soil structure: Each primary structural type of soil is differentiated into five size classes based on the size of the individual peds. They are as follows:

- Very fine or very thin
- Fine or thin
- Medium
- Coarse or thick
- Very coarse or very thick.

III. Grades of Soil Structure: Grades of soil structure indicates the durability of the individual peds.

Structure less - There are no visible peds or aggregates. If the appearance is coherent as in compact clay the term massive is used and if non-coherent as in loose sand it is called single grain.

Weak - Poorly formed, non-durable, indistinct peds that break into a mixture of a few entire and many broken peds.

Moderate - Moderately well developed peds, which are fairly durable and distinct.

Strong - Very well formed peds, which are fairly durable and distinct.

A. Difference between structure and texture

Structure - It is the arrangement of soil particles with each other and it can be changed or improved by operations like ploughing, puddling, addition of organic matter, etc.

Texture - It is the proportion of soil particles (sand, silt and clay). It cannot be changed by physical manipulation like ploughing or puddling; but can be improved through addition of organic matter like FYM, tank silt etc.

B. Role of soil structure in irrigation management

It plays a vital role in soil-air-water system. In surface soil, structure is associated with tilth of soil. The permeability of water and air into the soil and penetration of roots are influenced primarily by soil structure. It is the determining factor for the soil porosity, bulk density, etc. Hence it directly plays a role on water retention, permeability, etc.

There are two distinct phases in the formation of soil structure *viz.*, 1. Development of interparticle bonds (aggregates), and 2. Separation of structural units from each other (between aggregates). The structural composition of aggregates will vary in their characteristics. Their resistance against raindrop and their condition under submergence. This stability depends upon clay content, nature of flocculation, organic and inorganic linkage, microbes, chemical constituents such as iron and aluminum oxides.

Under excess water condition - Small pores are not important since there is no need for retaining water for longer time. But pores are needed for better air circulation.

Under dry farming condition - Both the aeration and water storage are needed to facilitate infiltration and retention.

In general, the good soil structural aggregate should be

- Stable to withstand rainfall
- Stable to withstand submerged condition
- Sand sized or gravel sized
- Rounded edged
- Having Friable condition but not too loose
- Having High infiltration capacity
- Having Medium percolation capacity
- Having Good aeration.

C. Soil structure management

The management practices like proper land use, suitable tillage practice at optimum moisture level, addition of organic matter, crop rotation, optimum fertilization, mulching, drainage, controlled irrigation, soil conservation, protection against compaction and use of soil conditioner may be tried for better soil structure management.

D. Soil physical properties with reference to volume–weight relationship

This relationship can be simply explained through a schematic diagrams as indicated below:

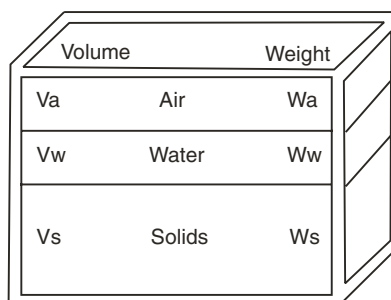

Fig. 5.4 Schematic diagrams

Va	–	Volume of air
Vw	–	Volume of water
Vs	–	Volume of solids
Vp	–	Volume of pore space alone (Va + Vw)

V_t	–	Total volume = $V_a + V_w + V_s$ (or) $V_p + V_s$
W_a	–	Weight of air (negligible)
W_w	–	Weight of water
W_s	–	Weight of solids
W_t	–	Total Weight = $W_a + W_w + W_s$

5.2.1.3 Density of Solids (DS) or Particle Density

It is defined as the ratio of weight of solid to its volume alone.

$$DS = \frac{\text{Mass of solid}}{\text{Volume of solid}} = \frac{W_s}{V_s \times P_w}$$

Where, P_w = density of water at 4°C. Since density of water = 1, this can be written as

$$DS = \frac{W_s}{V_s} \text{ and expressed in g/cc.}$$

5.2.1.4 Dry Bulk Density

It is defined as the ratio of mass of dried particles to the total volume of soil including pore spaces.

$$= \frac{W_s}{V_t} = \frac{W_s}{V_a + V_w + V_s} = \frac{W_s}{V_p + V_s}$$

expressed in g/cc

5.2.1.5 Real Specific Gravity

It can be defined as the ratio of the weight of any volume of soil particles to the weight of an equal volume of water and hence known as real specific gravity or true specific gravity which is more than or equal to particle density.

$$\frac{\text{Wt. of unit volume of soil solid}}{\text{Wt. of an equal volume of water}}$$

5.2.1.6 Apparent Specific Gravity (ASG)

It is the ratio of weight of unit volume of dry soil including pore spaces to weight of an equal volume of water.

$$ASG = \frac{\text{Wt. of unit volume of solid + pores}}{\text{Wt. of an equal volume of water}}$$

This has a unit (g/u) and is equal to dry bulk density. The bulk density or apparent specific gravity plays a vital role in irrigation. The bulk density is influenced by structure, texture and compaction of soil. Bulk density influences the water holding capacity, infiltration rate, hydraulic conductivity, water movement etc.

5.2.1.7 Wet Bulk Density

It is the ratio of unit mass of moist soil per unit volume of moist soil. This is also called as total bulk density.

$$\frac{W_t}{V_t} = \frac{W_s + W_w + W_a}{V_s + V_w + V_a}$$

5.2.1.8 Soil Wetness

The soil wetness refers to the relative water content in the soil. It can be described as mass wetness and volume wetness.

(a) *Mass wetness* - It is the ratio of mass wetness to the mass of the soil.

$$MW = \frac{\text{Mass of water in soil}}{\text{Mass of soil}}$$

This is commonly called as soil moisture content or gravimetric moisture content and generally expressed in percentage. It ranges from 25% to 65% depending upon the bulk density.

(b) *Volume wetness* - Relative water content expressed in volume basis of water and soil

$$\begin{aligned} &= \frac{\text{Volume of water in soil}}{\text{Total soil volume}} = \frac{V_w}{V_t} \\ &= \frac{V_w}{V_s + V_a} + V_w \end{aligned}$$

Degree of saturation - Represents to the volume of water present in the pore spaces.

$$\text{Degree of saturation} = \frac{V_w}{V_a + V_w} = \frac{V_w}{V_p}$$

This is also known as Relative saturation.

$$\text{Relative saturation volume} = \frac{\text{Volume of water filled in pore space}}{\text{Total pore volume}}$$

5.2.1.9 Pore Space

Soil is a porous material consisting of particles of different sizes touching each other but leaving spaces in between. These spaces, which are not occupied by the soil particles, are known as pore space.

A. Role and its importance

It constitutes about 40 to 60% of soil in volume basis. It provides space for water and air circulation and it plays a vital role in irrigation management. There are two types of pore spaces *viz.*, micro pore and macro pore. There is no sharp line of demarcation between the macro and micro pores. The macro pores allow the ready movement of air and permeability of water freely. In contrast, the micro pore air movement is greatly difficult and water movement is restricted to slow capillary movement. The volume of pore spaces varies according to the texture, structure and organic matter content. Soils having big particles contain less pore space than those having small particles. Thus the volume of pore space in an enclosed container having big particles is less than that of small particles. The size of individual pores is highly important for the movement of water in soil than the percentage of total pore space in soil. For example, percentage of pore space is high in clay soil, which contains more micropores where water movement is highly restricted and thereby water-holding capacity is more. In sandy soil, the

percentage of pore space is relatively less than clay soil, but it contains large number of macropores. Hence, the water movement is free. Addition of organic matter increases the volume of pore space by lowering the bulk density. Similarly mechanical manipulation or stirring of soil, decomposition of vegetation, root penetration, etc., increase the pore spaces. If macropores are more in top layer, (0–30 cm depth) it is desirable for easy movement of air and water and rapid infiltration of water.

Between 30 and 150 cm depth, equal amount of macro and micropores are essential to allow sufficient moisture, and permit moderate percolation to lower layer, which acts as storage reservoir. Below 150cm depth mostly micropores are desirable so as to help to:

- retain more moisture.
- To replenish the moisture in the upper layer whenever it is depleted.
- To restrict deep percolation loss.

B. Void ratio or relative porosity

It is the ratio of volume of pores to the volume of solids alone. Here the above ratio between the volume of pores to volume of solids alone excluding of pore space is taken for consideration. Porosity is the comparison between the volume of pores to the total volume of soil *i.e.*, including pore space is given consideration. Hence this index has certain advantage and accuracy over porosity.

Capillary and non-capillary pores - The soil pores are also classified as capillary and non-capillary pores based on their role in the movement of water or conductance of water.

- (i) **Capillary pores** - They retain the water after gravitational drainage of water is ceased or stopped. This water available to plants is held with the forces of cohesion, adhesion and surface tension. Here the capillary porosity is the percentage that is occupied by capillary water.
- (ii) **Non capillary pore space** - This is also termed as aeration pores. Non-capillary pores are large pore spaces and do not hold water with tension. Since the water movement is not restricted, its movement is relatively high and thereby the pore space cannot hold water except condition of saturation. Generally, this pore space is occupied with soil air. Hence, non-capillary porosity is the percentage of pore space filled with air. The large non-capillary porosity of sandy soil results in better drainage and aeration with low water holding capacity than the clay soil whereas the clay soils have larger proportion of small capillary pores which restricts the movement of water and hence water holding capacity is high but drainage is difficult. An ideal soil has pore space of equal amount of capillary and non-capillary pores and solids and pore spaces in equal proportion.

5.2.2 Soil/irrigability Classification

Soil is the reservoir for water in retaining and supplying the soil moisture to plant growth. The periodical recharging of water in soil pore spaces can be made either by irrigation or rainfall. The recharged water has to be supplied to plant system. This retention capacity and supply capacity varies from soil to soil based on its physical and chemical properties. Based on this, soil classification is made for its suitability for irrigation. This classification is also known as irrigability classification. Generally, soil can be broadly grouped as shallow soil and deep soil.

- (i) **Shallow soil** - It means the actual depth of soil profile to hold moisture is very less and depth of soil medium available for plant to extend its root system for tapping water and nutrients is less.
- (ii) **Deep soil** - The soil profile depth is more to hold moisture and the depth of soil medium available for plant roots to extend its branches to tap water and nutrients is also more. The recent

classification of soil for irrigability classes in arid and semi arid regions are as follows. This classification can be adopted to our country.

Class A	–	No soil limitation
Class B	–	Moderate soil limitation
Class C	–	Severe soil limitation
Class D	–	Very severe soil limitation
Class E	–	Not suitable for irrigation

A. Grouping of soil based on their suitability for irrigation

Based on the suitability, the soils are grouped into 5 classes as I to V for the purpose of irrigation, survey and mapping as follows.

Group I - It is indicated in green colour in soil mapping. The soil has the characteristic features of:

- Good available moisture holding capacity
- Low water table
- Low salts either soluble or exchangeable
- No soil crust and pan formation
- Negligible sodium amount.
- Negligible sub soil salinity.
- Good Internal permeability.

Group II - Group II is marked in yellow colour. The soil has the following characteristics of:

- Moderately suitable for irrigation
- Relatively higher, salt and exchangeable sodium content is more than group I
- Deep soil with loamy sand texture; some permeable clay may be there
- Subsoil is also permeable in nature.

Group III - It is indicated in red colour.

- Limited irrigation is practiced with limited cropping intensity
- Available soil moisture holding capacity is medium
- Medium water table
- Moderate salt content and exchangeable sodium percentage
- Moderate internal permeability
- No soil crust or pan formation within the root zone
- Sub soil water may be slightly to moderately saline.

Group IV - It is indicated in blue colour. This soil group is usually not suitable for irrigation. Reclamation work such as addition of organic manures, sand, silt, and application of gypsum may bring the soil under irrigation. It has the characteristic features of:

- shallow depth due to rocky substrata
- hard impervious pan formation
- high soil pH
- more soluble salt content (0.5%)
- low moisture supplying capacity
- low internal permeability.

Group V - It is indicated in dark green colour.

- The soil is shallow in depth
- Total soluble salt and exchangeable sodium percentage is high (more than 25%)
- Stony impervious layers
- Severe crust and pan formation are common
- It cannot be reclaimed by normal reclamation work

The soil grouping may be again grouped based on the following limitation

- Erosion/drainage which is indicated by the symbol (O)
- Drainage, wetness or overflow indicated by (W)
- Root zone limitation indicated by the symbol (S)
- Climate limitation indicated by the symbol (C)

Based on the dominance, the limitation will be ranked serially.

B. Irrigability classes and rating

It is very difficult to classify the lands to determine their suitability for irrigation. The bureau of reclamation, USA has developed a system to classify the suitability of various lands for irrigation agriculture. The system uses six classes.

Class I

- Land topographic and drainage characteristic are highly favourable for irrigation.
- Wide range of crops can be cultivated.
- Climate also highly suitable for wide range of crops.
- Higher Yield may be obtained with low cost.

Class II

- Capacity to produce crops may be high as that for class I land.
- Production, drainage and land development costs are higher.

Class III

- The capacity of the soil for crop production is moderately lower than class II.
- More extreme deficiencies or limitations with soil respect to drainage, topographic undulations even though it is suitable for irrigation.

Class IV

- Some lands in this may be costly to irrigate but due to intensive cropping the returns are adequate.
- The reclamation cost will be high in some lands.
- Yields of crops are very low with low cost of production.

Class V

- Normally unsuitable for irrigation: temporarily irrigation may be made under specific condition.

Class VI

- Lands will not pay for irrigation. A wide range of physical and economic constraints are there.
- Reclamation work is very difficult.
- In general the first four groups are suitable for irrigation. Class V is temporarily suitable and

Class VI is considered as unsuitable for irrigation.

Rating - In rating some characteristic features will be given important consideration. Based on their dominancy, soil will be rated. The rated characteristics for each land class are:

- depth
- organic matter content
- fertility
- ability to absorb moisture
- store and release of moisture for crops
- drainage characteristics
- salt content
- response to fertilizers
- erodability
- workability for implements

5.2.3 Soil Water or Soil Moisture

The soil moisture is the most important component or ingredient of the soil, which plays a vital role in crop production or plant growth. Water is retained as thin film around the soil particles and in the capillary pores by the forces of adhesion, cohesion and surface tension.

A. Adhesion

It is the force of attraction between molecules of different substance. That is the force of attraction between solid surface (soil mass) to liquid surface (soil water). A thin film of water is held in soil particles due to this adhesive force.

B. Cohesion

Cohesion is the force of attraction between molecules of same substances *i.e.*, between liquid molecules or water molecules. Hence, a thick film of water is formed due to this cohesive force.

C. Surface Tension

It is the total force acting in a solid-liquid-air system. The liquid surface has some properties of stretched elastic nature. This is due to the unequal forces of molecular attraction at the surface layer. This elasticity is known as surface tension. In other words, surface tension is defined as the "Force pulling tangentially along the surface of a liquid". This force tends to make the surface area as small as possible and has the dimension of force per unit length or energy per unit area expressed in Newton/meter (N/m) or dynes/cm. As a result of this surface tension, the air-water interspace become curved.

D. Soil moisture tension

Soil moisture tension is the tenacity with which water is held in the soil. To remove this water, some pressure (force per unit area) must be given or exerted. This pressure or tenacity is measured in terms of potential energy of water and is expressed in atmosphere or bars.

$$1 \text{ atmosphere} = 1036 \text{ cm water column or } 76.39 \text{ cm of mercury}$$

$$1 \text{ Bar} = 1023 \text{ cm water column}$$

To convert the soil moisture tension to equivalent atmosphere, the above conversion ratio can be used.

But here, there is no real vertical pressure of water column. Hence, it can be stated as suction or negative pressure. Hence, soil moisture tension of one atmosphere is approximately equal to suction or a negative pressure of 1000 cm of water column. At different soil moisture constants the soil moisture tension will vary. For example, the loam or clay type of soil retains moisture at a tension of 1/3 atmosphere at field capacity level, whereas the sandy soil has a tension of as low as 1/10 atmosphere. The available soil moisture is not only the function of soil physical characteristics like texture and structure but also the soil depth.

E. Kinds of Soil Water

The soil water can be classified based on their nature of attachment to the soil particles.

- Hygroscopic water
- Capillary water
- Gravitational water

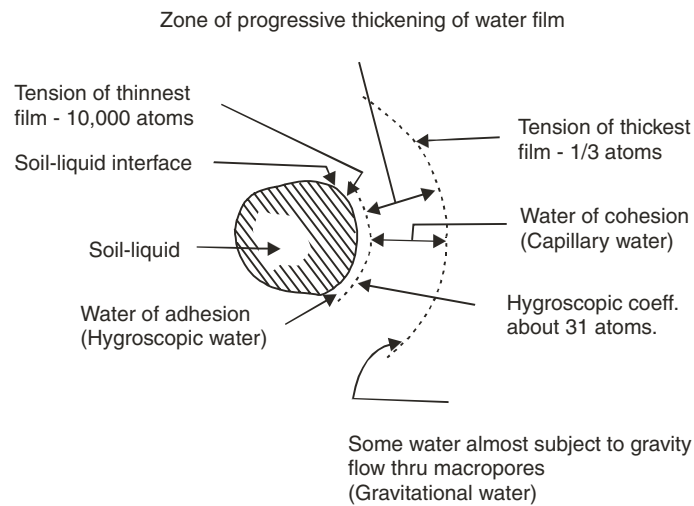

Fig. 5.5 Kinds of soil water

1. **Hygroscopic water** - This is the first stage of soil water content where water is held tightly by the surface of the soil particles by the forces of adhesion or adsorption force. Hence, it is also known as water of adhesion. At this condition the tension with which water is held in soil surface is from 10,000 atmosphere to 31 atmosphere. So the plant cannot exert this much of energy to extract the water from the soil particles. Hence, it is the unavailable form of water. This condition mostly occurs at permanent wilting point stage or dry condition.
2. **Capillary water** - This is the next stage after attaining hygroscopic water, with reference to soil-water relationship. In this stage there is relatively better thick film of water around the soil particles and between the soil particles. Hence, the cohesive force is responsible for the attraction of water molecules with each other. At this condition some of the pore spaces are not filled with water. Only the micro pores are filled up with water and little chances for macro pores to hold water. This condition will appear at field capacity level where the water is held at a tension of one-third atmosphere to 15 atmosphere. The water is available to the plants because plants

can exert the same amount of energy to extract this water. Hence, it is known as available water. When water comes in contact with the surface of soil particles, it will be attracted by the surface of the soil by adhesive force and gravitational force. At the same time there is repulsion for this attraction due to cohesive force along the liquid surface. This elasticity is known as surface tension. Due to the surface tension, the liquid tries to move tangentially along the water surface. This movement is called capillary water movement and the available water to plant is decided by the capillary water, which will be the function of pore space, which again depends upon the soil texture, structure and organic matter.

Texture - Finer the texture greater is the capillary capacity.

Structure - Granular structure produces higher capillary capacity

Organic matter - More organic matter increases the capillary capacity

3. **Gravitational water** - It is the third stage of soil water where water that moves freely as response to gravity percolates downwards and drains out to deeper layer of soil profile. It is also known as free water. At this condition, the macro and micro pores are completely filled up with water. There is no space for air movement in soil pore spaces. This state will appear when the soil is under saturation.

5.3 SOIL CLASSIFICATION

Any classification helps to understand the subject in question systematically and effectively with reference to all characteristics. Soil taxonomy groups the soil in orderly and logical and hierarchical manner involving successive sub divisions. Modern soil taxonomy considers soil and natural body and has two major features.

- The classification system is based on all soil properties which can easily be verified by other scientists, and
- The unique nomenclature has given a connotation or expression of major characteristics of the soil.

Purpose

- Besides attempting the genetic relationship, it helps to communicate all scientists with a specific language, which is a shorthand impression on the nature of the soil profile.
- It helps the soil scientists to remember the soil properties very easily.
- It easily establishes the relationship between soil individuals.
- It predicts the soil behaviour with reference to the purpose for which put into.
- It identifies the soils best uses.
- It also helps to estimate the soil productivity and helps to identify soils for research and agro technology transfer.

In order to establish the interrelationship between soil characteristics, the soils require to be classified. The major soil groups of India are as follows:

5.4 MAJOR SOILS OF INDIA

5.4.1 Alluvial Soils (Entisols, Inceptisols and Alfisols)

The alluvial soils are the most important soils from the agricultural point of view.

Characteristics - These soils are derived from the deposition laid by the numerous tributaries of the Indus, the Ganges and the Brahmaputra systems. The products of weathering of rocks in the Himalayas are brought down and materials transported by water, ice, gravity and wind. The alluvial soils include the deltaic alluvium, calcareous alluvial soils, coastal alluvium and coastal sands. This is the largest and most important soil group of India. It contributed the largest share to India's agricultural wealth. Broadly this soil is divided into two types:

Newer alluvium: Sandy, generally light coloured and less kankary.

Older alluvium: More clayey in composition, generally dark and full of Kankar.

Formation of hard pans (impervious layer) is often observed in Indo-gangetic alluvial soils of Uttar Pradesh and West Bengal. In Assam, old alluvium at hills is more acidic than the new alluvial soils along the riverbanks, which are often neutral or alkaline. In general alluvial soils are low in N except in Brahmaputra valley where they are moderate. Alluvial soils are found in Indo-gangetic plains of Uttar Pradesh, West Bengal, Bihar and Brahmaputra valley of Assam. Alluvial soils are fertile and suitable for most of the agricultural crops like lowland rice, pulses, cotton, banana etc.

5.4.2 Black Soils (*Entisols, Inceptisols, Vertisols*)

Characteristics - Black Soils are dark grey in colour, which is due to the presence of clay-humus complex. Black soils are:

- mainly formed from Deccan basalt trap parent material
- occur in monsoon climate, mostly of semi-arid and sub humid type
- alternate dry and wet periods and calcification favours black soil formation
- Cracks are formed on the surface soil (from 0.5-1 cm up to 6 cm wide) during summer
- mixing of soil along the entire solum
- highly clayey (35-60% clay); Calcareous with high CEC (30-50 C mol/kg of soil)
- high swelling and shrinkage, plasticity and stickiness
- impeded drainage and low permeability
- high content of exchangeable calcium and management
- poor in organic matter, N and available P_2O_5 .

Suitable crops - Cotton, Sugarcane, Groundnut, Millets, Maize, Pulses, Safflower

5.4.3 Red Soils (*Alfisols, Inceptisols, Ultisols*)

Characteristics - The red colour of soils is due to the coating of ferric oxides on soil particles. Red soils are:

- formed from granites, gneiss and other metamorphic rocks either *in-situ* or from decomposed rock materials
- with Argillic subsurface horizon
- Occur in semi-arid tropics
- Light textured, friable, absence of lime and $CaCO_3$ and low contents of soluble salts
- Kaolinite with an admixture of illite clay minerals
- Well drained with moderate permeability
- Excess gravelliness, surface crusting, susceptibility to erosion.

Suitable crops : Maize, Wheat, Millets, Groundnut and Pigeon pea.

5.4.4 Laterites and Lateritic Soils (*Ultisols, Oxisols, Alfisols*)

Characteristics

- Eluviations of silica and enrichment with oxides of Fe and Al. (Laterization process)
- Occurrence of plinthite or a pallid zone above water table.

High level laterite: not useful for agriculture (thin and gravelly).

Low level laterite: clays and loams in coastal regions.

- Laterization is intensified with increase in rainfall but with low intensity
- Low Silica/Sesquioxide ratio ($\text{SiO}_2 : \text{R}_2\text{O}_3$)
- Rich in nutrients and contain 10-20% organic matter (Low pH)
- Low in Ca and Mg but well drained and porous
- Kaolinite and traces of illite clays (CEC 2-7 C.mol/kg)

Suitable crops: At lower elevations: Rice

At higher elevations: Tea, Coffee, Cinchona, and Rubber

5.4.5 Desert Soils (*Aridisols, Entisols*)

Characteristics

- Sand dunes and undulating sandy plains
- Presence or accumulation of alkaline earth carbonates
- Clay content is very low (<8%)
- Presence of sodic clay (dispersion and less permeable) with pH 8.0-8.8.
- Presence of phosphate and nitrate makes desert soils fertile and productive under water supply
- Dominantly illitic with smaller amount of kaolinite, chlorite, vermiculite

5.4.6 Tarai Soils (*Mollisols*)

Tarai soils are derived from the materials washed down by the erosion of mountains (alluvial origin).

Characteristics

- Hard clay, coarse sand and gravel (parent material)
- Relatively high moisture content for the greater part of the year results in luxuriant vegetation
- Organic matter content is high
- Sandy loam to silty loam in texture

Suitable crops: Tall grasses.

5.4.7 Saline and Sodic Soils (*Aridisols, Inceptisols, Alfisols, Entisols, Vertisols*)

A. Saline soils

These soils contain excess amounts of neutral soluble salts dominated by chlorides and sulphates of Na, Ca and Mg, which affect plant growth. White encrustation of salts occurs on the surface of the saline soils hence called as “*White alkali*”. These soils are characterized by EC: 4dSm^{-1} at 25°C ; ESP : < 15; pH: < 8.5. These soils need leaching and drainage before cropping. The crops grown in these soils are grouped as:

- High salt tolerant:* Sesbania, rice, sugarcane, oats, berseem, lucerne, indian clover and barley.
- Medium salt tolerant:* Castor, cotton, sorghum, cumbu, maize, mustard and wheat.
- Low salt tolerant:* Pulses, peas, sunnhemp, gram, linseed, sesamum.

B. Sodic/Alkali Soils

These soils contain high content of CO_3 and HCO_3 of Na. Hence, they are with high exchangeable sodium percentage (ESP). Generally, they are non-saline and with dark encrustation hence called as “black alkali”. These soils are rich in NaHCO_3 and characterized by pH: > 8.5 ; EC: $< 4 \text{ d Sm}^{-1}$; ESP: > 15 . Use gypsum ($\text{CaSO}_4 \cdot 2\text{H}_2\text{O}$) as amendment for reclamation of sodic/alkali soils. Iron pyrites, (FeS_2) bulky organic manures (especially green manures) and crop residues which produce weak organic acids are also used for reclamation. Crops having tolerance are grown in the soils.

- (i) *Tolerant crops*: Kamal/rhodes/para/bermuda grass, rice, sugar beet.
- (ii) *Semi – Tolerant*: Wheat, barley, oats, berseem, and sugarcane.
- (iii) *Sensitive*: Cowpea, gram, groundnut, lentil, peas, and maize.

5.4.8 Acid Soils**Characteristics**

- Low pH with high amounts of exchangeable H^+ and Al^{3+} .
- Occur in regions with high rainfall.
- Laterization, Podzolization in areas with sub temperate to temperate climate.
- Significant amount of partly decomposed organic matter.
- Kaolinitic and Illitic.
- Low CEC and high base saturation.
- Liming and judicious use of fertilizers are the management measures suggested.

Suitable crops: Acedophytes (like potato).

5.5 MAJOR SOILS OF SOUTHERN INDIA – TAMIL NADU

In Tamil Nadu, the major portion is covered by red sandy soil and red loamy soils. Red sandy soils have developed from acidic parent material like granite, gneiss, quartzite, sandstone etc. The red colour of soils is due to the coating of ferric oxides on soil particles. Sand particles are coated with red coloured hematite or yellow coloured limonite, which is responsible for the various shades of red and yellow of these soils, which usually contain ferruginous gravel containing iron, aluminium and silica. These sandy, loamy sand and sandy loam soils are heavily leached and therefore, poor in basic elements and plant nutrients. Their pH ranges from 6.6-8.0. Calcium is the important exchangeable cation in these soils. They are neutral to slightly alkaline in reaction.

5.5.1 Black Soils or Vertisol

About 18 lakh ha occurs in all districts except Kanyakumari and Nilgiris. The soils are deep black cotton soil and old alluvial soils. Soils are very deep, clayey calcareous and poorly drained, develop cracks during summer, contains high amount of Ca, Fe and Mg. CaCO_3 is present in the form of Kankar nodules. Poor in organic matter, N and P, but fairly well supplied with K and lime. The soil reaction is mild alkaline (pH: 7.8-8.2) CEC is high (30-70 c. mol (p+) kg^{-1}). Black soils of Tamil Nadu, which are either shallow (3-4 ft, deep) or deep, are of very heavy texture, have a high moisture retention capacity, and are rich in lime and alkaline in reaction. They contain low amounts of nitrogen but sufficient amounts of phosphoric acid and potash. Mixed red and black soils occur in Coimbatore, Madurai, Ramanathapuram and Tirunelveli districts. Black soils are dominated by beidellite, while red soils are dominated by kaolinite. So the cation exchange capacity of red soils is maximum at an intermediate depth.

5.5.2 Laterite Soils

Laterite soils occur in the Chengalpet and Thanjavur districts. These were formed from different parent materials in humid climate. Paddy is grown in lower elevation and tea, cinchona, rubber and coffee are grown at the higher elevation. They are rich in humus and plant nutrients and strongly acidic in reaction. Soil acidity increases with elevation.

5.5.3 Alluvial Soils or Entisols

It covers an area of more than 18 lakh ha in all districts except Madurai, Dindugal. The soils are river alluvium, Coastal alluvium and eroded soils. River alluvium is cultivated with wetland crops like rice, banana etc. In coastal alluvium casuarinas can be cultivated and made use of development of pastures. The texture of soil is sandy or fine alternate with sandy clays. The soils are poor in N, P, K and organic matter rich in clay and lime, CEC–25 cm (p+) kg, Si/sesquioxide is 2.5, Dominant clay minerals (2:1 type).

There are two kinds of alluvium—**Deltaic alluvium** occurs in the Thanjavur district and a belt of **coastal alluvium** covers Tamil Nadu from Chennai to Kanyakumari. **Alluvial soils** are most extensive and most fertile. They are very deep, the solum sometimes extending over several feet. These soils consist of alternate layers of silt, clay and sand of varying thickness. The texture of the surface soil is usually loamy. The **Cauvery alluvium** is poor in humus, nitrogen and phosphorus, but rich in potash and lime. These soils possess a low cation exchange capacity and are alkaline in reaction. Soils developed from Cuddalore sandstone are loamy in texture and, yellow and light yellow and even grayish white in colour and deficient in humus, nitrogen, phosphorus and lime. The profile characteristics of coastal alluvial soils formed from recent marine deposits are similar to Cauvery alluvium in their alternate layers of clay, silt and sand but exhibit influence of sea indicated by the presence of shells and bleached sand. They are poor in nitrogen and available phosphorus but rich in potash and lime. Some of them also contain salts.

5.5.4 Peaty Soils

Peaty soils, which occur mainly on the south-east coast of Tamil Nadu, are usually coloured blue due to the presence of ferrous iron. They contain varying amounts of organic matter.

5.5.5 Problem Soils

Problem soils such as acidic, saline and sodic soils are also found in Tamil Nadu. Soils of Kanyakumari, The Nilgris districts are mostly acidic. Area of alkalinity is scattered in many districts. Coastal salinity occurs in districts like Thiruvallur, Cuddalore, Nagapattinam, Thiruvarur, Ramanathapuram, Pudukkottai and Tirunelveli with poor drainage and high evaporation. Inland salinity is also noted in few pockets of Tamil Nadu.

5.5.6 Alfisols

It is distributed in an area of more than 31 lakh ha in all districts except hills. Soils are well drained, very deep, reddish in colour and well developed surface horizon, pH; 6.5-8, low in total soluble salts, CEC 10-15 c.mol (p+) kg⁻¹, low in N and P, medium to high in K, cultivated with pulses under dry condition; Groundnut & cotton under irrigated conditions.

5.5.7 Inceptisols

This soils are distributed in all districts of Tamil Nadu and covers an area of more than 22 lakh ha. The soils included are moderately deep red, brown and black soils in moderately well developed sub soil.

The soils are cultivated with sorghum, groundnut, cumbu, pulses and tapioca. Under irrigated condition, groundnut, maize, onion, tapioca etc. Poor in lime N, P, rich in Kaolinite clay minerals, CEC 10-15 c.mol(p+)kg⁻¹.

5.5.8 Ultisols

Area 36, 499 ha occur in Salem, Dharmapuri, Nilgiri districts crops cocoa, coffer and cold vegetables very deep and highly weathered soil, dark coloured surface with high organic matter (2-5%) acidic in soil reaction, CEC: 3-15 c.mol (p+) kg⁻¹, poor in bases, phosphorus is not available, *i.e.*, fixed by Fe and Al.

5.6 PROBLEM SOILS

5.6.1 Saline Soils

Saline (Solonchak, Russian term) soil are defined as a soil having a conductivity of the saturation extract (EC) greater than 4 dSm⁻¹ and an exchangeable sodium percentage (ESP) less than 15. The pH is usually less than 8.5. Formerly these soils were called white alkali soil because of surface crust of white salts. The saline soils are originating due to accumulations of soluble salts. The most soluble salts in saline soils are composed of the cations sodium, calcium, magnesium and the anions chloride, sulphate and bicarbonate. Usually smaller quantities of potassium, ammonium, nitrate and carbonate also occur.

A. Sources of Soluble Salts

There are various sources from which soluble salts are accumulated in the soil.

- (a) **Primary minerals** - During the process of chemical weathering (hydrolysis, hydration, solution, carbonation and oxidation) various constituents like Ca²⁺, Mg²⁺ and Na⁺ are gradually released and made soluble.
- (b) **Arid and semi arid climate** - Salt affected soil are mostly formed in arid and semi arid regions where low rainfall and high evaporation prevails.
- (c) **Ground water** - If ground water contains large amounts of water soluble salts, irrigation of such water leads to accumulation of salts in soil.
- (d) **Ocean or seawater** - Seawater enters into the land by inundation and deposited on the soil surface as salts. In arid regions near the sea, appreciable amount of salts are blown by wind year after year and get deposited on the surface soil. The salinity of Rajasthan are mostly developed through this source.
- (e) **Excessive use of basic fertilizers** - Use of basic fertilizers like sodium nitrate, basic slag etc. may develop soil alkalinity.

B. Genesis/Origin

The process by which the saline soil formed is called 'salinization'. Saline soils occur mostly in arid or semi arid regions, which have very low rainfall and high evaporation. The low rainfall in these regions is not sufficient to leach out the soluble products of weathering and hence the salts accumulate in the soil. During rainy season the salts dissolve in rainwater and move down to lower layers. However, due to limited rainfall, the downward movements are restricted to a short distance only. In dry weather, the salts move up with the water and are brought up to the surface where they are deposited as the water evaporates. With alternate downward and upward movements of rainwater, the salts get concentrated in the surface layer and form a 'white' efflorescence'.

Restricted drainage is another factor that usually contributes to the soil salinization and may involve the presence of a high ground water table.

C. Characteristics

- When the soil contains excess of sodium salts while in clay complex still contains preponderance of exchangeable calcium.
- The salts usually present in saline soils are the chlorides, sulphates, bicarbonates and sometimes nitrates of sodium.
- Soluble carbonate are usually absent.
- Among the anions, sulphates and chlorides are present in greater proportion than nitrates and bicarbonates.
- Sodium forms less than 50% of the total cations present in soil solution. The presence of chlorides and sulphates of sodium gives a white colour on the surface and such soil is known as “White alkali”. When nitrates are in excess, they give a brown colour to the soil and this soil is known as “brown alkali”.
- The pH of soil is <8.5, ESP <15 and EC while be >4 dSm⁻¹.
- Wilting coefficient of saline soil is very high.
- Amount of available soil moisture is low.
- Excessive salts in the soil solution increases the osmotic pressure of soil solution in comparison to cell sap. This effect makes it more difficult for plant roots to extract water and nutrients.
- High concentration of soluble salts produces toxic effect directly to plants such as root injury, inhibition of seed germination.

D. Criteria for characterization of saline soils

Different criteria are employed for characterizing soil salinity.

- (a) **Soluble salt concentration in soil solution** - In saline soil the soluble salt concentration in soil solution is very high and as a result osmotic pressure of the solution is also very high. As a result of which the plant growth is affected due to wilting and nutrient deficiency. Salt content more than 0.1% is injurious to plant growth.
- (b) **Osmotic pressure (OP)** - Osmotic pressure of the soil solution is closely related to the rate of water uptake and the growth of plants in saline soils. The relation between OP and electrical conductivity (EC) for salt mixtures found in saline soils is given below.

$$OP = 0.36 \times EC \text{ dSm}^{-1}$$

- (c) **EC of the soil saturation extract** - Measurement of EC of the soil saturation extract is also essential for the assessment of saline soil for the plant growth.

EC (dSm⁻¹)

<2	–	Salinity effects mostly negligible
2-4	–	Yields of very sensitive crops may be restricted
4-8	–	Yields of many crops restricted
8-16	–	Only tolerant crops yield satisfactorily
>16	–	Only a few tolerant crops yield satisfactorily

- (d) **Concentration of water -soluble boron** - The determination of water soluble boron concentration is also an another criteria for characterization of saline soils. The critical limits of boron concentration for the plant growth is given below.

Boron concentration (ppm)

<0.7	–	Crops can grow (safe)
0.7-1.5	–	Marginal
>1.5	–	Unsafe

- (e) **Soil texture** - A sandy soil with 0.1% salt would be enough to injure the growth of common crops, while a clayey soil with the same amount of salt may be just a normal soil in which the yields of even sensitive crops would not be affected. The US Salinity Laboratory has developed the concept of saturation percentage which depends on texture of soil and that is used for characterizing saline soil.

E. Reclamation

In saline soils, reclamation consists mainly in removing the excess salts. This can be done either.

- By scraping the salt from the surface (or)
- Washing them down into lower layer beyond the root zone preferably completely out of the solum (or)
- By growing salt tolerant crops (or) by a combination of two (or) more of these methods.

Scraping helps to remove salts that have formed an encrustation on the surface, but it is never very helpful in complete reclamation. Substantial quantities of soluble salts are still present in the soil body and hinder plant growth. The growing of salt tolerant plants with a view to remove salts is also not a practical proposition. Although these plants remove fairly substantial quantities of salts from the soil, comparatively larger quantities are still left behind. Salt formation is a continuous process, hence the reclamation is never complete.

- (a) **Leaching requirement (LR)** - It may be defined as the fraction of the irrigation water that must be leached through the root zone to control the soil salinity at any specified level. LR can be calculated as per the following formula

$$LR = \frac{D_{dw} \times 100}{D_{iw}} \text{ or } \frac{Ec_{iw} \times 100}{EC_{dw}}$$

where

LR	–	Leaching requirement in percentage
D_{dw}	–	Depth of drainage water in inches
D_{iw}	–	Depth of irrigation water in inches
EC_{iw}	–	EC of irrigation water (dSm^{-1})
EC_{dw}	–	EC of drainage water (dSm^{-1})

If the soil is not free draining, artificial drains are opened (or) tile drains laid underground to help in washing out the salts.

(b) Growing of salt tolerant crops

High salt tolerant crops	–	rice, sugarcane, sesbania, oats
Medium salt tolerant crops	–	castor, cotton, sorghum, cumbu
Low salt tolerant crops	–	pulses, pea, sunnhemp, sesamum

5.6.2 Alkali Soils (Sodic/Solonetz)

Alkali (or) sodic soil is defined as a soil having a conductivity of the saturation extract less than 4 dSm⁻¹ and an ESP of > 15. The pH is usually between 8.5-10.0. Formerly these soils were called “black alkali soils”.

A. Genesis/origin

It is evident that soil colloids adsorb and retain cations on their surfaces. Cation adsorption occurs as a consequence of electrical charges at the surface of the soil colloids. While adsorbed cations are combined chemically with the soil colloids, they may be replaced by other cations that occur in soil solution. The reaction whereby a cation in solution replaces an adsorbed cation is called cation exchange and is expressed as meq/100 g.

Calcium and magnesium are the principal cations found in the soil solution and on the exchange complex of normal soils in arid regions. When excess soluble salts accumulate in these soils, sodium frequently becomes the dominant cation in the soil solution. In arid regions as the solution becomes concentrated through evaporation or water absorption by plants, the Ca²⁺ and Mg²⁺ are precipitated as CaSO₄, CaCO₃ and MgCO₃, with a corresponding increasing of sodium concentration. When the Na⁺ concentration is more than 50% of the total cations a part of the original exchangeable Ca²⁺ and Mg²⁺ replaced by sodium resulting in alkali soils.

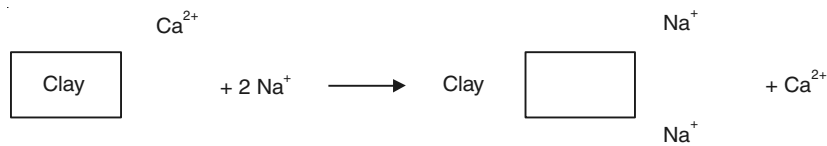

Though the reaction is reversible, Ca²⁺ are removed in drainage water as soon as they formed. Hence, the reaction proceeds in one direction from left to right only. The process whereby a normal soil is converted into an alkali soil is known as “alkalization”.

B. Characteristics

There are various methods employed for characterizing alkali soils.

- A direct determination of exchangeable sodium in sodic soils will serve as a guide for reliable appraisal of alkali conditions.
Exchangeable sodium = Total sodium–soluble sodium
- The soil pH also gives an indication of soil alkalinity indirectly. An increase in pH reading of 1.0 or more, with change in moisture content from a low to high value has itself been found useful in some area for detecting alkali conditions.
- The higher the ESP, the higher is the soil pH
- Sodium Adsorption Ratio (SAR).

C. SAR

The US salinity laboratory developed the concept of SAR to define the equilibrium between soluble and exchangeable cations as follows.

$$\text{SAR} = \frac{\text{Na}^+}{\sqrt{\frac{\text{Ca}^{2+} + \text{Mg}^{2+}}{2}}}$$

(Na^+ , Ca^{2+} , Mg^{2+} are concentrations in saturation extract in me.l^{-1}).

The value of SAR can be used for the determination of exchangeable sodium percentage (ESP)

$$\text{ESP} \approx \frac{100(-0.0126 + 0.0147 \text{ SAR})}{1 + (-0.0126 + 0.0147 \text{ SAR})}$$

The following regression equation is also used to work out ESP of alkali soils

$$Y = 0.0673 + 0.035 X$$

Y indicates ESP and X indicates SAR

Soils having SAR value greater than 13 are considered as sodic soils.

D. Impact of Soil Sodicty

- Dispersion of soil colloids leads to development of compact soil
- Due to compactness of soil, aeration, hydraulic conductivity, drainage and microbial activity are reduced
- High sodicty caused by Na_2CO_3 increases soil pH
- High hydroxyl (OH) ion concentration have direct detrimental effect on plants
- Excess of Na^+ induces the deficiencies of Ca^{2+} and Mg^{2+}
- High pH in alkali soil decreases the availability of many plant nutrients like P, Ca, N, Mg, Fe, Cu, Zn.

E. Reclamation

- (a) **Conversion** - As alkali soil contains Na-clay, it gets dispersed and becomes sticky and impervious as soon as the salts are washed out. As a result, the downward movement of water stops and the soil gets waterlogged. Thus in the case of such soil it is necessary to remove the exchangeable sodium before the removal of soluble salts so that the physical condition of the soil is not impaired. While removing exchangeable sodium, the presence or absence of calcium carbonate in the soil has to be taken into consideration. If the soil has no reserve CaCO_3 , the addition of CaSO_4 (Gypsum) is necessary.
- (b) **Gypsum Requirement (GR)** - The main principle for the reclamation of sodic soil is to replace exchangeable sodium by another cations say Ca^{2+} . Of all calcium compounds, gypsum ($\text{CaSO}_4 \cdot 2\text{H}_2\text{O}$) is considered to be the best and cheapest for the reclamation purpose. Gypsum requirement is determined from the formula

$$\text{GR} = \frac{\text{ESP}(\text{initial}) - \text{ESP}(\text{final}) \times \text{CEC}}{100}$$

where,

ESP (initial) is obtained from soil analysis before reclamation

ESP (final) is usually kept at 10 since this value is considered safe for tolerable physical conditions of the soil

CEC-cation exchange capacity (meq/100 g)

When gypsum is applied to alkali soil, the following reaction will take place. Ca^{2+} solubilized from gypsum replaces Na^+ leaving soluble sodium sulphate in the water, which is then leached out.

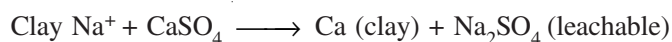

The other soil amendments suitable for different soil conditions are indicated below:

<i>Amendments</i>	<i>Soil conditions</i>
Sulphur FeSO ₄ FeS ₂	Alkaline soils having pH range 8.0–9.0
Limestone	Saline soils having pH less than 8.0
Gypsum	Alkali soils having pH range upto 9.0

(b) **Salt precipitation theory** - Recently salt precipitation theory is employed satisfactorily for the reclamation of sodic soils. The elimination of salts and exchangeable sodium from soils by leaching is presently practicing, but the leached salts have been washed into groundwater or streams, making those water more salty. Due to use of such water the soils are further subjected to salt problems. With this view, a new concept in managing soils has been developed and that is known as precipitation of salts. The idea suggests that instead of leaching salt completely away, they can be leached to only 0.9-1.8 m deep (3-6 ft) where much of the salts would form as slightly soluble gypsum or carbonates (CaCO₃, MgCO₃) during dry periods and not react any longer as soluble salts. The ions precipitating will be mostly those of Ca²⁺, Mg²⁺, CO₃, HCO₃ and SO₄. The management technique is simply to apply less water, but to do it more carefully and ensure inform depth of wetting.

(c) **Other management practices** - Application of FYM, green manure, sulphur, molasses, aluminium sulphate and even sulphuric acid have been found to be effective reclaiming agents. Growing salt tolerant crops like rice, berseem and daincha is recommended.

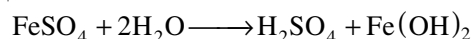
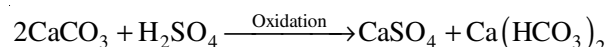
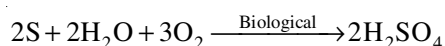

The crop roots help to increase the permeability of subsoil by excreting CO₂ and developing cracks in it. The CO₂ neutralizes alkalinity by lowering the soil pH to a certain extent and the cracks allow more easy percolation of water. Both these processes hasten the removal of sodium salts and wash them to deeper layers.

(d) **Prevention**

- Avoid excess water table by following judicious water management practices
- Ensure free and efficient drainage
- Flooding of land with large quantities of water must be avoided
- Evaporation should be checked as far as possible by mulching or by providing proper shade.

It has been estimated that about 7 million hectares of land in India are salt affected (Saline-alkali soils).

Table 5.2. Difference between Saline Soil and Alkali Soil

Sl.No.	Saline soil	Alkali soil
1.	Formed by accumulation of soluble salts (Salinization)	Formed due to adsorption of Na ⁺ on the exchange complex (Alkalization) pH is >8.5
2.	PH < 8.5	ED is <4 dSm ⁻¹
3.	EC is > 3 dSm ⁻¹	ESP is >15
4.	ESP is <15	Black alkali soils
5.	White alkali soils	Nitric horizon
6.	Salic horizon	Carbonates will be present
7.	Free carbonates are absent	Prismatic/columnar structure
8.	No well developed structure	SAR is > 13
9.	SAR is < 13	Reclamation by applying amendments
10.	Reclamation by leaching	gypsum, sulphuric acid etc.
11.	Solonchalk	Solonetz

5.6.3 Saline-Alkali Soils

Saline alkali soil is defined as a soil having a conductivity of (EC) greater than 4 dSm⁻¹ and an exchangeable sodium percentage (ESP) greater than 15. The pH is variable and usually above 8.5 depending on the relative amounts of exchangeable sodium and soluble salts.

A. Genesis/origin

These soils are formed as a result of the combined process of salinization and alkalization. If the excess soluble salts of these soils are leached downward, the properties of these soils may change markedly and become similar to those of sodic soil. As the concentration of these salts in the soil solution is lowered, some of the exchangeable sodium hydrolyzes and form sodium hydroxide. This may change to sodium carbonate upon reaction with CO₂ absorbed from the atmosphere.

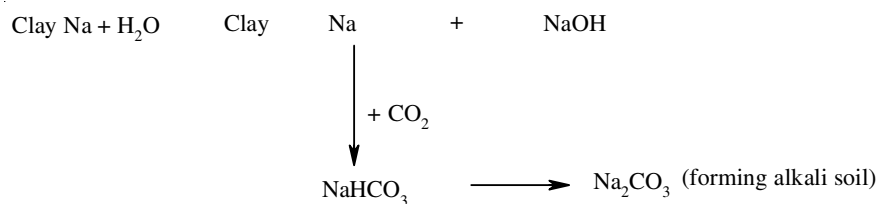

B. Reclamation

In these soils, it is necessary to remove the exchangeable sodium before the removal of soluble salts so that the physical condition of the soil is not impaired.

Degraded alkali soils - If the extensive leaching of a saline-sodic soil occurs in the absence of any source of Ca²⁺ or Mg²⁺, part of exchangeable sodium is gradually replaced by hydrogen. The resulting soil may be slightly acidic with unstable structure. Such soil is called degraded alkali or sodic soils.

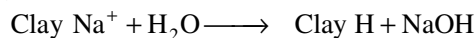

(Acid soil on surface horizon) Leaching

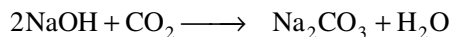

Sodium carbonate (Na_2CO_3) dissolves humus and is deposited in the lower layer. The lower layer thus acquires a black colour. At the same time H-clay formed in this way does not remain stable. The process of break down of H-clay under alkaline condition is known as “solodization”.

5.7 SOIL PRODUCTIVITY CONSTRAINTS

5.7.1 Physical Constraints

The following are the physical constraints.

- Highly permeable soils
- Impermeable soils (slowly permeable)
- Crusted soils
- Subsoil hard pan
- Fluffy paddy soils

1. *Highly permeable soils*

The high permeability is associated with sand and loamy sand texture of soils. These soils occur in coastal areas, river delta and in the desert belts. These soils cover large areas in Rajasthan and Haryana. In Tamil Nadu, a total area of about 15 lakh ha were affected by excessively permeable soils.

Characteristics

- The structure of soil is loose to very weakly developed depending upon clay content.
- Since most sandy soils are devoid of any structural development, these suffer from intensive erosion.
- Lack of cohesion, adhesion and plasticity in soil.
- The nature of excessive permeability of the sandy soils results in very poor water retention capacity, very high hydraulic conductivity and infiltration rates. So whatever the nutrients and water added to these soils are not utilized by the crops and subjected to loss.
- Soils are lighter in colour.
- Very low in organic carbon, nitrogen and medium in P and K.
- Low nutrient diffusivity and buffering capacity.

Remedial measures - To correct the textural weakness of these sandy soils and to make them suitable for sound farming, various ameliorative measures have been devised.

- Introduction of artificial barriers in the subsoil zone using asphalt, bitumen and cement have been found to arrest the higher rate of nutrient and water losses in sandy soils. This technology is costly.
- **Compaction technology** - The soils should be ploughed uniformly. About 24 hours after a good rainfall (or) irrigation, the soil should be rolled 10 times with 400 kg stone roller of 1 m long (or) an empty tar drum filled with 400 kg sand. This practice increases the bulk density of 0-30 cm layer to optimum range ($1.5-1.7 \text{ mg/m}^3$). Then, shallow ploughing should be given and crops can be raised.

- By mixing of a fine textured soil having 50% clay would reduce the hydraulic conductivity and infiltration rate and also increases the N use efficiency.
- Application of mulches is an effective means to conserve soil water and moderate soil temperature.
- Form small plots and apply minimum and frequent irrigations.
- Adopt more number of splits of N and K fertilizers.

2. Slowly permeable soils

The slow permeable soil is mainly due to very high clay content and poor drainage conditions which results in poor aeration and water stagnation and ultimately leads to poor crop growth and in certain case leads to complete death of crops. The slow permeability of the soil is mainly associated with black clay soils. These soils cover an area of 49.8 m.ha in the Central India comprising Madhya Pradesh, Andhra Pradesh, Gujarat and in Tamil Nadu, about 14.32 lakh ha of land affected by these soils.

Characteristics

- Very high clay content and bulk density
- Poor drainage, hydraulic conductivity and infiltration rate due to higher proportion of pores
- Temporary water logging of the soil develops oxygen stress in root zone
- Development of salinity with poor drainage
- High soil pH and calcareousness may promote ammonia volatilization
- Soils are low in organic carbon N, P, Zn and Fe

Remedial measures

- Addition of organics namely FYM/composted coir pith/press mud/urban compost at 12.5 t/ha found to be optimum for the improvement of the physical properties. It facilitates water movement to the root zone.
- **Formation of ridges and furrows:** For rain fed crops, ridges are formed along the slopes for providing adequate aeration to the root zone. Interception of drainage channels of about 50 cm wide and 15 cm deep provides effective surface drainage.
- **Raised and sunken beds formation in between adjacent raised beds:** The bulk density was found to be reduced due to increase in non-capillary pores in upper 10 cm layer of raised bed besides increase in yield of crops by forming raised and sunken beds. The 6–12 m wide and 20 cm high raised beds alternating with 6 m wide sunken beds provides *in situ* drainage. The raised beds are constructed by removing the soil from the sunken beds.
- **Formation of broad beds:** To reduce the amount of water retained in black clay soils during first 8 days of rainfall, broad beds of 3–9 m wide should be formed either along the slope (or) across the slope with drainage furrows in between broad beds.
- The productivity of sodic clay soils can be increased to a significant extent through use of gypsum and agricultural grade iron pyrites.
- Long term application of organic manures along with chemical fertilizer under well aerated condition improves the available status of nutrients.

3. Subsoil hard pans

The reasons for the formation of subsurface hard pan in red soils is due to the illuviation of clay to the subsoil horizons coupled with cementing action of iron, aluminium and calcium carbonate. In Tamil Nadu, red soils occupy about 8 million hectares. The occurrence of hard pan at shallow depths is the major prevalent soil physical constraints in these soils.

Characteristics

- The subsoil hard pan is characterized by high bulk density (more than 1.8 Mg m^{-3}), which in turn lowers infiltration, water holding capacity, available water and movement of air and nutrients with concomitant adverse effect on the yield of crops.
- The high bulk density in sub surface soil results in water stagnation on the soil surface after heavy rainfall (or) irrigation and the crops turn yellow due to oxygen stress.
- In high rainfall areas, sub surface layers at shallow depth reduce water storage capacity of the soil and run off starts even after a short shower, which cause floods in low-lying areas.

Remedial measures

To eradicate the problem of subsoil impervious layer, chisel plough is recommended. Chisel plough is a heavy iron plough which goes up to 45 cm depth, thereby shatters the hard pan in the subsoil.

- The field is to be ploughed with chisel plough at 50 cm interval in both the directions
- Chiseling helps to break the hard pan in the subsoil
- Farm yard manure (or) press mud (or) coir pith at 12.5 t/ha is to be spread uniformly on the surface
- The field should be ploughed with country plough twice for incorporating the added manures
- The broken hard pan and incorporation of manures make the soil to conserve more moisture

4. Soil surface crusting

Surface crusting is due to the presence of colloidal oxides of iron and aluminium in Alfisols, which binds the soil particles under wet regimes. On drying it forms a hard mass on the surface. The alluvial sandy loam soils in Haryana, Punjab, Rajasthan, Uttar Pradesh, Bihar and West Bengal form a crust on the soil surface, which interferes with germination and growth of crops. The red sandy loam soils 'Chalkas' which cover a large area of Andhra Pradesh become very hard on drying with the result that the crop growth is adversely affected. In Tamil Nadu, this problem is prevalent mostly in red soil areas (Alfisols) and is of greater magnitude in districts like Trichy, Pudukottai, Ramnad and Tirunelveli. The crusting of soils is directly related with aggregate stability, rainfall characteristics and its chemical composition. The poorly aggregated soil particles in alluvial, red and lateritic soils disintegrate easily under the impact of rain drops. The quantity of dispersed soil increases with the increase in drop size, drop velocity and rainfall intensity. The hydration of aggregates causes a disruption through the process of swelling and explosion of entrapped air. The fine fractions go into the suspension, which may either enters into the soil and clog the macropores or resettles on the surface to form a crust.

(a) Impact on soil properties

- Prevents germination of seeds
- Retards/inhibits roots growth
- Results in poor infiltration
- Acceleration of surface run off
- Creates poor aeration in the rhizosphere
- Affects nodule formation in leguminous crops.

Soil crusting generally found in laterite group of soils, which have high amounts of soluble iron and alumina.

(b) Remedial measures

- when the soil is at optimum moisture regime ploughing is to be given.

- lime at 2 t ha⁻¹ may be uniformly spread and another ploughing given for blending of the amendment with the surface soil.
- FYM at 10 to ha⁻¹ (or) composted coir pith at 12.5 t ha⁻¹ (or) other organics may be applied to improve the physical properties of the soils after preparation of land to optimum tilth.
- combined application of lime and FYM enhanced the yield of crops besides improving the physical properties of the soil.
- scarping surface soil by tooth harrow will be useful.
- bold grained seeds may be suited for sowing on the crusted soils
- more number of seeds/hill may be adopted for small seeded crops.
- sprinkling water at periodical intervals may be done wherever possible.
- resistant crops like cowpea can be grown.
- most of the red and laterite soils are poor in organic matter and therefore deficient in nitrogen. Organic manures and use of biofertilizers holds promise.
- these soils having high activity of Fe and Al in soil solution fix a good amount of soluble P. Application of rock phosphate will increase the available P and crop yield.

5. Fluffy paddy soils

The traditional method of preparing the soil for transplanting rice consists of puddling. This results in substantial break down of soil aggregates into a structure less mass. The solid and liquid phases of the soil are thus changed. Under continuous flooding and submergence in rice-rice-rice sequence, the soil particles are always in a stage of flux and the mechanical strength is lost leading to the fluffiness of the soils. This is further aggravated by *in situ* incorporation of rice stubbles and weeds during puddling. In Tamil Nadu fluffy rice soils are prevalent in Cauvery deltaic zone and in many parts of the state due to the continuous rice-rice cropping sequence.

Impact

- Sinking of draught animals and labourers is one of the problems during puddling in rice fields.
- Fluffiness of the soil led to very low bulk density and thereby leading to very rapid hydraulic conductivity and in turn the soil does not provide a good anchorage to the roots and the yield of crops is adversely affected.

Remedial measures

- The irrigation should be stopped 10 days before the harvest of rice crop.
- After the harvest of rice, when the soil is under semi-dry condition (proctor moisture level), compact the field by passing 400 kg stone roller or on empty drum filled with 400 kg of sand 8 times.
- Then the usual preparatory cultivation is carried out after compaction.

5.7.2 Chemical Constraints

The details on saline soil, alkali soil, saline-alkali soils are given in the previous sections of the chapter.

5.7.2.1 Acid soils

Out of 157 million hectares of cultivable land in India, 49 million hectares of land are acidic. Acid soil is a base unsaturated soil which has got enough of adsorbed exchangeable H⁺ ions so that to give soil

a pH of lower than 7.0. The following important sources are responsible for the development of acidic soils.

A. Sources of formation

- (a) **Leaching due to heavy rainfall** - Acid soils are common in the regions where rainfall is high enough to leach appreciable amounts of exchangeable bases from the surface soils and relatively insoluble compounds of Al and Fe remains in soil. The nature of these compounds is acidic and its oxides and hydroxides reacts with water and release hydrogen ions in soil solution and soil becomes acidic.
- (b) **Acidic parent material** - Some soils have developed from parent materials, which are acid, such as granite and that may contribute to soil acidity.
- (c) **Acid forming fertilizers and soluble salts** - The use of ammonium sulphate and ammonium nitrate increases soil acidity. For (e.g.), ammonium ions from $(\text{NH}_4)_2\text{SO}_4$ when applied to the soil replace calcium ions from the exchange complex and the calcium sulphate is formed and finally leached out.

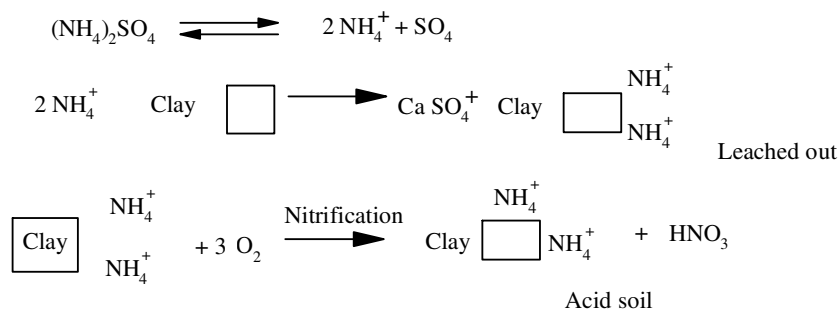

- (d) **Humus and other organic acids** - Humus materials in soils occur as a result of microbiological decomposition of organic matter and contain different functional groups like carboxylic ($-\text{COOH}$), phenolic ($-\text{OH}$) etc., which are capable of attracting and dissociating H^+ ions. During organic matter decomposition, humus, organic acids and different acid salts may be produced which increases the total acidity of soil.

Aluminosilicate minerals - At low pH values most of the aluminium (Al) is present as the hydrated aluminium ions (Al^{3+}), which undergoes hydrolysis and release hydrogen (H^+) ions in the soil solution.

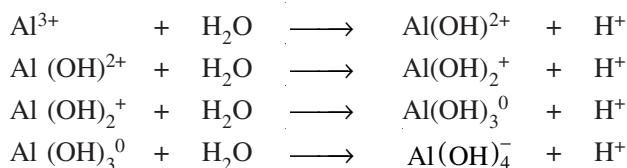

Carbon dioxide (CO_2) - Root activity and other metabolism may serve as sources of CO_2 , which ultimately leads to acidity in soil. Soil containing high concentration of CO_2 will have low pH.

Hydrous oxides - These are mainly oxides of iron and aluminium. Under favourable conditions they undergo stepwise hydrolysis with the release of H^+ ions in the soil solution and develop soil acidity.

Aluminium in the development of soil acidity - Hydrogen ion contribute soil acidity directly while aluminium ions do so indirectly through hydrolysis. In aqueous solutions, Al^{3+} does not remain

as a free ion, but it is surrounded by six molecules of water forming hexaquoaluminium compound $\text{Al}(\text{H}_2\text{O})_6^{3+}$. Hydrolysis of the monomeric hexaquo aluminium are illustrated by the following stepwise reactions with the liberation of hydronium ion (H_3O^+) and lower soil pH.

Stepwise hydrolysis	Dominant aluminium species $\text{Al}(\text{H}_2\text{O})_6^{3+}$	pH levels
$\text{Al}(\text{H}_2\text{O})_6^{3+} + \text{H}_2\text{O}$	$\text{Al}(\text{H}_2\text{O})_5(\text{OH})_2^+ + \text{H}_3\text{O}^+$	< 4.7
$\text{Al}(\text{H}_2\text{O})_5(\text{OH})_2^+ + \text{H}_2\text{O}$	$\text{Al}(\text{H}_2\text{O})_4(\text{OH})_2^+ + \text{H}_3\text{O}^+$	4.7–6.5
$\text{Al}(\text{H}_2\text{O})_4(\text{OH})_2^+ + \text{H}_2\text{O}$	$\text{Al}(\text{H}_2\text{O})_3(\text{OH})_3^+ + \text{H}_3\text{O}^+$	6.5–8.0
$\text{Al}(\text{H}_2\text{O})_3(\text{OH})_3^+ + \text{H}_2\text{O}$	$\text{Al}(\text{H}_2\text{O})_2(\text{OH})_4^+ + \text{H}_3\text{O}^+$	8.0–11.0

Under strongly acid soils, the adsorbed aluminium is in equilibrium with Al^{3+} ions in the soil solution and that Al^{3+} ion in solution produces H^+ ions through the process of hydrolysis

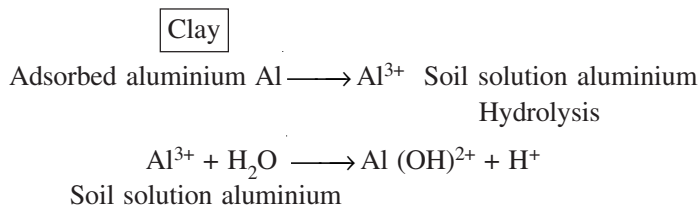

Under moderately acid soils, the percentage of base saturation and pH values are somewhat higher. At such higher pH values, aluminium exists as aluminium hydroxy ions and again on hydrolysis liberate H^+ ions in soil solution.

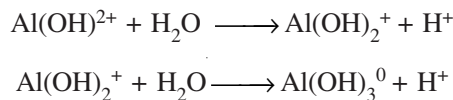

B. Kinds of soil acidity

Soil acidity may be of two kinds viz., 1. Active acidity, and 2. Potential/reserve/exchange acidity.



- (a) **Active acidity** - Active acidity may be defined as the acidity developed due to hydrogen (H^+) and aluminium (Al^{3+}) ions concentration of the soil solution. The magnitude of this acidity is limited.
- (b) **Exchange acidity** - Exchange acidity may be defined as the acidity developed due to adsorbed hydrogen (H^+) and aluminium (Al^{3+}) ions on the soil colloids. The magnitude of this exchange acidity is very high.

$$\text{Total acidity} = \text{Active acidity} + \text{Exchange acidity}$$

C. Impact of soil acidity

Problems of soil acidity may be divided into three groups:

1. Toxic effects

- (a) Acid toxicity

(b) Toxicity of different nutrients

2. Nutrient availability

(a) Non-specific effects

(b) Specific effects

(i) Exchangeable bases

(ii) Nutrient imbalances

3. Microbial activity

D. Toxic effects

(a) **Acid toxicity** - The H^+ ion concentration is toxic to plants under strong acid conditions of soil.

(b) **Toxicity of different nutrient elements** - The concentration of Fe^{2+} and Mn^{2+} in soil solution depends upon soil pH, organic matter and soil redox condition. Due to increase in organic matter content in the soil, the population of soil microbes increases and very rapidly use the soil oxygen and results in reduced soil condition. As a result of reduction, the nutrient elements like Mn^{4+} and Fe^{3+} reduce to Mn^{2+} and Fe^{2+} respectively and toxicity of these elements develops. Due to such toxic effects, a physiological disease of rice is found in submerged soils, which is popularly known as “browning disease”.

(c) **Toxicity of Aluminium (Al)** - Al toxicity in soils affects plant growth in various ways:

- It restricts the root growth.
- It affects various physiological processes like division of cells, formation of DNA and respiration etc.
- It restricts the absorption and translocation of nutrients like P, Ca, Fe, Mn etc., from soil to plant.
- It causes wilting of plants.
- It also inhibits the microbial activity in soil.

(d) **Nutrient imbalance** - It is evident that soluble iron, aluminium and manganese are usually present in higher concentration under strong acidic conditions. Phosphorus react with these ions and produces insoluble phosphatic compounds rendering phosphorus unavailable to plants. Besides these, fixation of P by hydrous oxides of iron and aluminium also reduces the P availability. In acid soils Fe, Mn, Zn, Cu are abundant but molybdenum and boron availability are decreased. N, P and S become less available in acid soil having pH less than 5.5.

(e) **Microbial activity** - Bacteria and actinomycetes function better in soils having moderate to high pH values. They can not sustain their activity when the soil pH drops below 5.5. Free living N fixing bacteria (*Azotobacter sp.*), and symbiotic N fixing bacteria (*Rhizobium sp.*) activities are inhibited under acidic condition. Fungi can grow well under very acid soils and causes disease like root rot of tobacco, blights of potato etc.

E. Amelioration of soil acidity

One of the most important feasible management practices is the use of lime and liming materials to ameliorate the soil acidity.

(a) Lime requirement

It may be defined as the amount of liming material that must be added to raise the pH to some prescribed value. This value is usually in the range of pH 6.0 to 7.0 since this is an easily attainable value within the optimum range of most of the crop plants. Kinds of liming materials are:

- Oxides of lime – CaO (Burned lime)
- Hydroxides of lime – Ca (OH)₂ (Slaked lime)
- Carbonates of lime – CaCO₃ (calcite) and Ca Mg(CO₃)₂ (Dolomite)
- Basic slag (By product of steel industry)

Principles of liming reactions - Reaction of lime in soils depends upon the nature and fineness of the liming materials. Lime is usually applied to soils in the form of ground limestone. The greater the partial pressure of CO₂ in soil, the more soluble the limestone becomes. The reaction of limestone (CaCO₃) can be written as

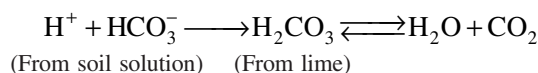
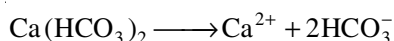
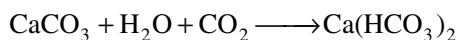

In this way, hydrogen (H⁺) ions in the solution react to form weakly dissociated water and calcium ion from limestone is left to undergo cation exchange reactions. The acidity of the soil is, therefore, neutralized and the percent base saturation of colloidal material is increased.

(b) Why gypsum is not considered as liming material

Gypsum, on its application dissociates into Ca²⁺ and SO₄²⁻

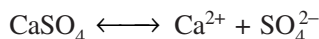

The accompanying anion is sulphate and it reacts with the soil moisture produces mineral acid H₂SO₄ which also increases soil acidity instead of reducing soil acidity.

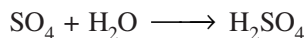

(c) Influence of lime on soil properties in relation to plant nutrition

Direct benefits

- Toxicity of Al³⁺ and Mn²⁺ is reduced
- Reduced uptake of Ca²⁺ and Mg²⁺ in the soil solution can be alleviated
- Removal of H⁺ ion toxicity.

Indirect benefits

- The application of liming materials in acid soils will inactivate the iron and aluminium, thus increase the available P
- The toxicity of most of the micronutrients (Fe, Mn, Cu, Zn) can be prevented by the application of lime
- Most of the organisms responsible for the conversion of ammonia to nitrates (NH₃NO₃) require large amounts of active calcium. As a result nitrification is enhanced by liming to a pH of 5.5–6.5
- The process of N fixation both by symbiotic and non-symbiotic is favoured by liming
- The structures of fine textured soil can be improved by liming

- The amelioration of soil acidity by liming may have a significant role in the control of plant pathogens, *e.g.*, Club root disease of Cole crops can be reduced by liming
- Liming increases the efficiency of different fertilizers especially N and P fertilizers.

(d) Over liming

If liming materials are applied over and above its requirement then it is called over liming.

(e) Effects of over liming

When excessively large amounts of lime are applied to an acidic soil, the growth of plants is affected by influencing either one or many of these following:

- Deficiency of iron, copper and zinc will occur
- P and K availability will be reduced
- Due to high OH ion concentration by over liming, root development will be inhibited
- Boron deficiency will occur
- The incidence of diseases like scab in root crops will be increased

5.7.2.2 Acid sulphate soils

Soils with sufficient sulphates (FeS_2) will become strongly acidic when drained and aerated enough for cultivation. These are termed as acid sulphate soils or as in the Dutch refer to those soils as cat clays. When allowed to develop acidity, these soils are usually more acidic pH than 4.0. Before drainage, these soils may have normal pH and if soils undergo aeration the pH will be reduced and hence they are called “potential acid sulphate soils”. Generally acid sulphate soils are found in coastal areas where the land is inundated by salt water. In India, acid sulphate soil is mostly found in Kutanad (Kerala), Orissa, Andhra Pradesh and West Bengal.

A. Formation

Lands inundated with water that contain sulphates particularly salt water, accumulate sulphur compounds, which in poorly aerated soils are bacterially reduced to sulphides. Such soils are not usually acidic when first drained in water. When the soil is drained and then aerated, the sulphide (S^2) is oxidized to sulphate (SO_4) by a combination of chemical and bacterial actions, forming sulphuric acid (H_2SO_4). The magnitude of acid development depends on the amount of sulphide present in soil, conditions and time of oxidation.

Reactions involving the formation of acid sulphate soils - Acid sulphate soils are formed due to oxidation of sulphides in soils. The slow oxidation of mineral sulphides in soils is non biological until soil pH reaches to 4.0.

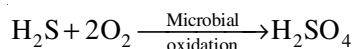
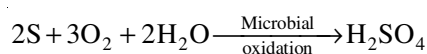

(Hydrogen sulphide)

Non-biological

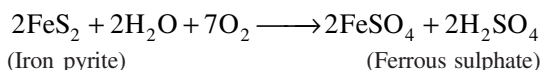

(Iron pyrite)

(Ferrous sulphate)

Accelerated by bacteria (*Thiobacillus ferroxidans*)

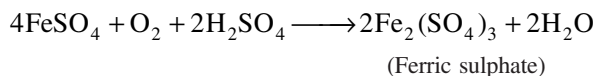

B. Characteristics

- It contain a sulphuric horizon which has a pH of < 3.5 plus some other evidences of sulphide content (Yellow colour).
- Strong acidity in acid sulphate soils results in toxicities of aluminium, iron, manganese and hydrogen sulphide (H₂S) gas. H₂S often formed in low land rice soils causing “akiochi” disease that prevents rice plants roots from absorbing nutrients.

C. Management

Maintaining the reduced condition of flooded (anaerobic) soil inhibits acid development.

- Controlling water table** - If a non-acidifying layer covers the sulphuric horizon, drainage to keep only the sulphuric layer under water (anaerobic) is possible.
- Liming and leaching** - Liming is the primary way to reclaim any type of acid soil. Acid soil may require 11-45 MT/ha of lime in a 20-year period whereas, acid sulphate soil may require from several metric tones per hectare per year upto even 224 metric t/ha (100 t/ac) within a 10 year period. If these soils are leached during early years of acidification, lime requirements are lowered. Leaching however is difficult because of the high water table commonly found in this type of soil and low permeability of the clay.

5.7.3 Soil Survey

Soils are non-renewable natural resource of any country. A through knowledge of a soil is very essential for making all kinds of land use policies. To frame such land use policies, an inventory of soil resources of a country should be made first. Preparation of such inventory starts with soil survey. Without soil survey effective, land development projects, irrigation projects, development of wild life sanctuaries, parks laying out transport facilities cannot be executed property. The soil survey helps us in several ways. At national level, soil survey helps to prepare soil resource inventory and overall land related policies and plans. At state level, it is basic to form land related development schemes. It is also useful to delineate agricultural, forestry wastelands etc. At town level, soil survey reports are of immense use for town planning or locating areas for residential building, roads, parks, waste disposal sites, other sanitation facilities etc., In an agro climatic region, soil survey helps us in locating research stations and in identifying representative soils for conducting field experiment, on farm trials and demonstration plots. At farm level, it helps to identify the suitable crops, cropping sequence, irrigation and nutrient managements.

Soil survey can be defined as the study of soil in the field for their morphological and other characteristics supplemented by certain laboratory analysis, to classify the soils and map them into texa usually up to soil series level so as to enable any user to interpret their potentialities for different uses. In soil survey, we obtain the following information a through field examination and laboratory analysis. The information so obtained is used to interpret the utility of soil, limitation of soil for specific use and to suggest suitable soil management practices.

- A complete description of soil
- Distribution of different soil types

A. Objectives

A through knowledge of soil is very essential for effective land use planning and conservation. Soil

survey is the 1st step for any land use planning. The objectives of soil survey may be fundamental or applied (practical). The fundamental objectives of soil survey help thorough understanding of genesis and classification of soils. The applied objectives or practical aspects of soil survey are numerous. A few important applied practical objectives are listed below.

- To delineate cultivated soils, problem soils (such as saline soil, saline-alkali and alkali, water logged, drained soils, coarse and heavy textured soils and wastelands.
- To identify areas prone (subject) to wind and water erosion and suggest soil conservation measures.
- To identify areas suited to specific crops.
- To identify areas having one or more nutrient deficiencies or stresses.
- To identify areas for settlement, rehabilitation, tax, appraisal, location of rail lines, airport, roads, parks etc.
- To assess the suitability of area for irrigation and to assess the soil health due to irrigation etc.
- To provide soil related information to development agencies or department for planning optimum land use policies or executing that policies.

B. Types and methods of soil survey

Soil surveys are of different types depending upon the purpose, method, the intensity of survey and the nature of resulting map. These types vary from nation to nation.

- Explorative
- Reconnaissance
- Semi detailed
- Detailed reconnaissance
- Very detailed
- National etc.

Table 5.3. Details on type of Soil Survey and Maps

<i>Type</i>	<i>Scale of base map</i>	<i>Area/sq. cm of map</i>	<i>Traverse distance between observation</i>	<i>Frequency of observation</i>	<i>Mapping unit</i>	<i>Accuracy of soil boundaries</i>
Reconnaissance	1:250,000 1:100,000	625 100	1.0 km	1 in 625 ha 1 in 100 ha	Association of soil groups	Almost all boundaries are inferred
Semi detailed	1:50,000	25	500 m	1 in 25 ha	Soil series or association of soil series	Some boundaries are checked most inferred
Detailed low intensity	1:10,000	1	100 m	1 per ha	Phases and soil	Almost all boundaries are checked
High intensity	1:5,000	0.25	50 m	4 per ha	Phases and soil series	All boundaries are checked

Each type can be distinguished by the scale of map, typical soil mapping unit, typical land use capability and smallest area indicated on the map. In India, the following three types of survey are conducted.

- Reconnaissance survey
- Detailed survey
- Detailed reconnaissance survey

Besides the purpose of survey, the terrain features, time, budget and persons available for survey will decide the types of survey to be under taken.

C. Soil survey methods

The area to be surveyed is decided by the Government based on certain priorities in land development projects. Once the area to be surveyed is communicated to the soil survey authority, the first step in the soil survey is the collection of top sheet and preparation of base maps. The second step involves the organizing the survey team. Usually, there will be 2 scientists, a driver and 1 or 2 technicians. The team rapidly traverse the area to get overall picture of geology, physiography, land use etc., and prepare a preliminary legend. After the area visit, the preliminary legend will be reviewed and modified if necessary. This forms the pre-survey exercise. The next stage in the soil survey forms the pre-survey exercise in the field. Using the map again, the entire area is traversed to note physiographic relationship. Wherever necessary and whenever available cross section of road cuts, dug well, open quarries are examined visually, the soils are examined with augers. The broad soil series and its associations are demarcated on the map and legends are finalized. Location of master profiles is selected and examined for various morphological characteristics, and given in soil survey description sheet. Horizon wise soil samples are collected for laboratory studies. Soil boundaries are checked with auger samples and field examination is completed. All data regarding land use pattern, crops and cropping sequence, industries, irrigation sources, education, socio economic status, ecosystem in general are collected from all available sources.

(a) **Post field activities** - In the laboratory, the soil samples are analyzed usually for pH, EC, available N, P, and K etc. If the survey sponsor insists other analysis for special purposes, analysis for such characteristics are also carried out and profile sheets are edited and finalized. The various data collected from various sources are compiled and tabulated, and appropriate interpretations are made. The maps are finalized to demarcate the soil series.

(b) **Grid survey** - In grid survey, survey is taken in a larger area. The area is divided into number of grids and traverse line located on a grid pattern. Generally 4–5 observations per ha. Comparable observations were connected and mapped.

(c) **Free survey** - Here, the surveyor selects the observation points and observes the change in physiography using the aerial photographs. The density of observation will vary.

Seasons and Systems of Farming

Season is defined as “part of the year during which a distinguished type of weather prevails”. Season is a period in a year comprising few months during which the prevailing climate does not vary much. Growing season for a crop is more important for its yield and other management practices to be followed.

6.1 SEASONS

A. Seasons of Temperate Region

- *Spring* (March-May) is the first season of the year in which plants begin to grow and leaves emerge.
- *Summer* (June-August) is the second and warmest season of the year outside the tropics during which plants flourish.
- *Fall or autumn* (September-November) is the third season of the year in which leaves turn brown.
- *Winter* (December-February) is the last and the coldest season of the year. Many trees lose their leaves.

B. Seasons of India

According to India Meteorological Department (IMD), there are four seasons in a year, in India.

- (i) *Kharif/Monsoon or South-West Monsoon* (June–September)
- (ii) *Post monsoon (North-East Monsoon)* (October–November)
- (iii) *Winter* (December to February)
- (iv) *Zaid/Summer or pre-monsoon* (March to May)

The post monsoon and winter season are combined together and designated as *Rabi* (October to February) throughout India. Accordingly the agricultural seasons in India are called as *kharif, rabi and summer*.

C. Seasons of South India

In southern states of India (Tamil Nadu, Andhra Pradesh and Karnataka), there is slight variation in the season based on rainfall duration as follows:

- (i) *Cold weather period (winter)* : January–February

- | | | |
|--|---|------------------|
| (ii) <i>Hot weather period (summer)</i> | : | March–May |
| (iii) <i>South-West Monsoon period</i>
(Rainy season) | : | June–September |
| (iv) <i>North-East Monsoon period</i> | : | October–December |

6.1.1 Characteristics of Seasons

A. Winter or Cold weather

The weather prevailing during this period is cool, usually dry and pleasant with dewfall during morning hours. Occasional cyclonic depressions bring light rains to North-western regions in India. These rains though in small amount, are most beneficial to the winter crops. At times they do more harm than good, due to shedding of cotton bolls, damaging of tobacco quality.

B. Summer or Hot weather

This period is characterized by high temperature. The temperatures are higher in the north during this period than South India. Showers during this period are mainly useful for preparatory cultivation (summer ploughing). Gingelly and sorghum are sown with the rains. The garden land crops are benefited by these rains.

C. South-West monsoon

This is the rainy season in India except most part of the Tamil Nadu. About 60% of the rainfall in a year is received during this period. Most of the tropical crops (Kharif crops) are grown during this period. All dry lands and also wetlands directly depend on the rains received during this period. Garden land crops are also benefited by these rains. The climate prevailing during this period is warm and humid with bright sunshine except on rainy days (Tropical climate).

D. North-East monsoon

The temperature is high up to the middle of October and later starts falling rapidly. The rainfall received during the period is about 33% of annual rainfall except in Tamil Nadu and Coastal Andhra Pradesh where the annual rainfall received during this period is more than 55% half of it with occasional cyclones. The sky is clear in northern India. Mostly temperate (Rabi) crops are grown during this period.

6.1.2 Crop-wise Seasons

1. Rice seasons: Rice is grown in different seasons during a year.

A. Rice seasons in North India (West Bengal)

- | | | |
|------|---|--|
| AUS | : | May–September |
| AMAN | : | June, July–November, December (Kharif) |
| BORO | : | January–May (summer) |

B. Rice seasons

Totally seven seasons which vary with districts.

- (i) In Cauvery Delta (Thanjavore, Thiruvarur, Nagapattinam, parts of Villupuram, Tiruchirappalli, Pudukottai)

1. **Kuruvai** : June–September
2. **Early Samba** : July August–December January
- Samba** : August–January
- Late Samba** : September October–January February
3. **Thaladi** : September–January/February
4. **Navarai** : December–April

(ii) In Chengalput, Tiruvallur, Thiruvannamalai, Vellore, Kanchipuram, Villupuram and Cuddalore districts, there is one more season in addition to above four as,

5. **Sornavari**: April May–August September

(iii) In Tirunelveli and Kanyakumari districts, rice is grown in

6. **Kar**: May–September and
7. **Pishanam**: September–January

2. Cotton seasons

- (i) *Winter Irrigated* : August–September sowing
- (ii) *Summer* : February–March sowing
- (iii) *Rice fallow* : January–February sowing
- (iv) *Rainfed cotton* : September–October sowing

3. Sugarcane seasons

- (a) *Early Season* : December–January planting
- (b) *Mid Season* : February–March planting
- (c) *Late Season* : April–May planting
- (d) *Special Season* : June–July planting

6.1.3 Agronomic Concepts of the Growing Seasons

Agronomically the growing season can be defined as the period when the soil water, resulting mainly from rainfall, is freely available to the crop. This condition occurs when the water consumed by the crop is in equilibrium with rainfall and water storage in the soil. The growing season for a rainfed crop involves three different periods during which the soil moisture conditions depend on the rainfall received.

- (a) **Pre-humid period**: During this period the precipitation will always remain lower than the potential evapotranspiration for the corresponding period. This period corresponds to the sowing period of the crop. Sowing can be done when the precipitation during the week is > 0.5 PET.
- (b) **Humid period**: During this second period the precipitation remains higher than the PET. The crops in this period will be in active vegetative and flowering phase and the water requirement will be at its peak. At the end of this period water balance is on the positive side and the water storage in the soil is on the increase, since the rainfall is higher than the water needs.
- (c) **Post-humid period**: This period follows the humid period. During this period there is a gradual reduction in the water stored in the soil due to the utilization by the crop plants. The crops will also make use of the rainfall received. This period usually coincides with maturity stage of the crop.

A. Types of growing period

There are four types of growing period.

1. **Normal:** In this type, rainfall is in excess during the humid period. At the end of the pre-humid period when precipitation is higher than the 0.5 PET sowing the crops are taken up. This type of growing season is prevalent in semi arid tropics.
2. **Intermediate type:** The precipitation is lower than the PET all round the year. The growing season is limited to the period when rainfall is in excess of 0.5 PET. Only drought hardy crops like pearl millet, castor, etc., can be grown. Dry farming is highly risky.
3. **All year round humid:** In this type, the precipitation is more than PET all round the year, indicating the moisture sufficiency for cropping. This type occurs in high rainfall areas and mostly perennial crops are raised.
4. **All year round dry:** The precipitation is lower than 0.5 PET throughout the year. Cropping is not possible in these areas. This type of growing season is found in extremely arid areas, mostly the deserts.

The fluctuations in the crop yields depend on the following conditions.

- The length of the rainy seasons *i.e.*, from sowing to the end of the rains.
- The quantity and distribution of rains during the pre-humid and humid periods.
- The excess rainfall during humid period should go to soil storage. It may cause water logging and crop lodging.
- The amount of rainfall received during post humid season, may supplement the soil moisture during maturity. This may favourably influence the yield.

In India, four cropping seasons have been identified by IMD in dry farming areas.

Table 6.1. IMD seasons

S.No	Name of the season	Duration	Water need from rainfall	Crops
1.	Short duration	Up to 10 weeks	75%	Very short duration crops
2.	Medium duration	10-15 weeks	75%	Medium duration crops with intercrops
3.	Extended medium duration	15-20 weeks	75%	A medium duration crop followed by short duration crops if soil type is suitable
4.	Long duration	20-30 weeks	75%	Medium duration crops followed by short duration crops.

6.1.4 Effect of Season on Choice of Crops

Season influences the crop selection to a greater extent as it decides the growth and establishment of the crop. The weather conditions prevailing during a season totally governs the crop production. The fluctuation in the crop yield depends on the length of the rainy season, the quantity and regularity of distribution of rainfall and the amount of rainfall received after the rainy season. The climatic factors *viz.*, precipitation, wind, solar radiation (light and thermal energy) temperature, atmospheric air and its

pressure prevailing in a season very greatly influences the crop growth, establishment and yield as discussed in the earlier chapter on climatic factors affecting the crop production.

6.2 SYSTEMS OF FARMING

For better understanding of different systems of farming it is essential to study certain terminologies. Farm is a piece of land with specific boundaries, where crop and livestock enterprises are taken up under a common management. Farming is the process of harnessing solar energy in the form of economic plant and animal products or it is the business of cultivating land, raising livestock etc. System refers to an orderly set of interdependent and interacting components none of which can be modified

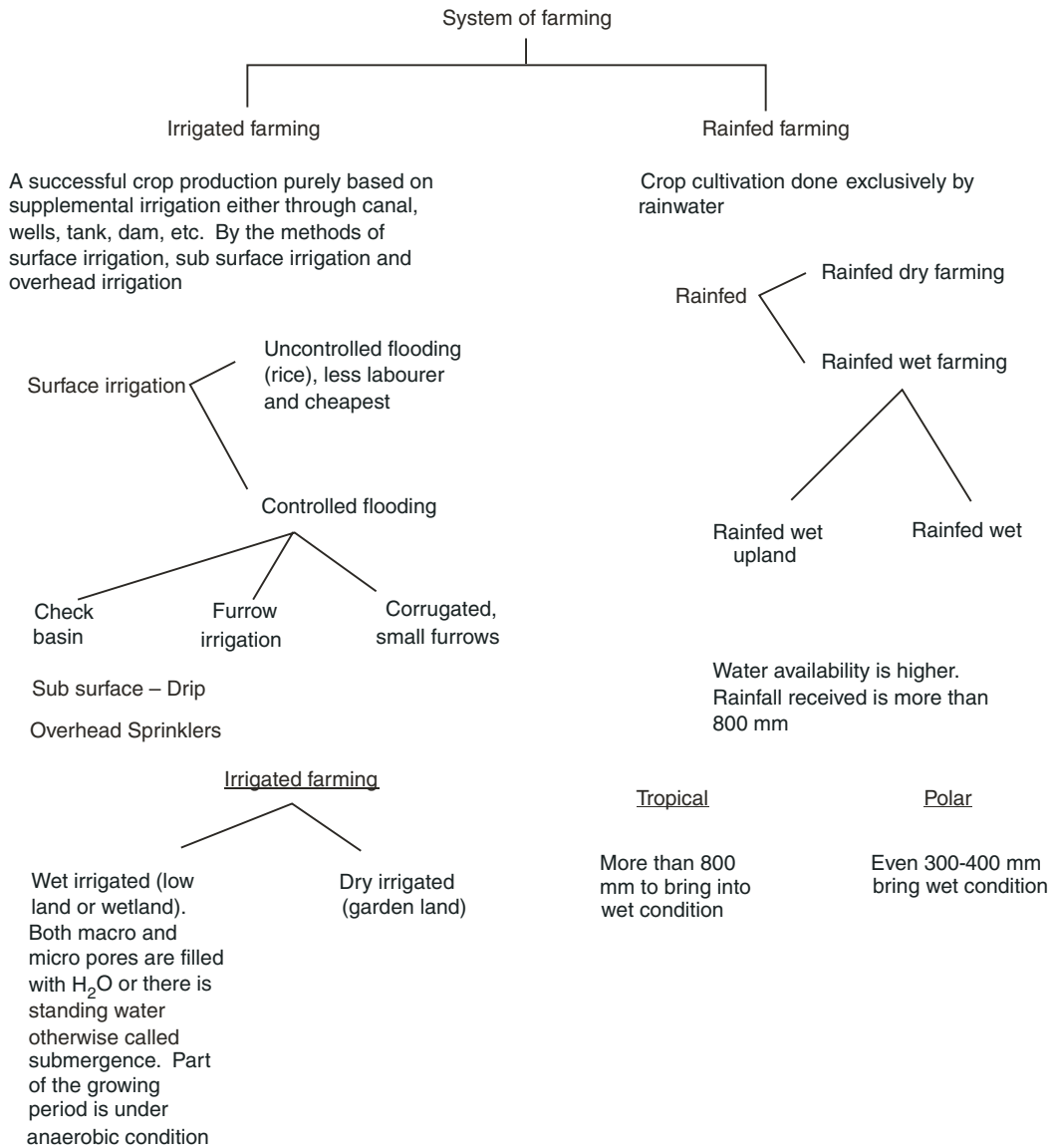

Fig. 6.1

without causing a related change elsewhere in the system. There are three distinct systems of farming as wetland system of farming, garden land (irrigated dry land) system of farming and dry land system of farming.

1. **Wet land** - Pertaining to soils flooded or copiously irrigated through lake or pond or tank for a least several weeks in each year (or) to crop growth in such soils. The water is not entirely under the control of the farmer.

Wetland Farming is the practice of growing crops in soils flooded through natural flow of water for most part of the year.

2. **Garden land** - The garden land system means the land supplied with water mostly from underground sources *i.e.*, irrigated dry land.

Garden land farming - Growing crops with supplemental irrigation by lifting water from underground sources. Crops grown in these lands are irrigated through lift irrigation and hence the water is under control.

3. **Dry Farming/Dry Land Farming** - It is the practice of crop production entirely with rainfall received during the crop season or with conserved soil moisture and the crop may face mild to severe stress during its life cycle. It is practiced in areas with an annual rainfall less than 800 mm (arid and semi arid).

Rainfed farming - In areas where the rainfall is more than 800 mm (humid and sub humid) the crops are grown entirely with the rainfall received during the crop season. The crop may face little or no moisture stress during its life cycle.

Lowland means the land submerged for most part of the year. Lowlands are mostly wetlands either with irrigation (irrigated) or with rainfall (rainfed).

Upland means the land unsubmerged and well aerated. Uplands are mostly dry lands.

Table 6.2. Comparison of some selected Features of different Farming Systems

Sl.No.	Features	Wetlands	Irrigated land	Dry land	Rainfed
1.	Farming practices (duration)	9-12 months	9-12 months	<6 months	6-8 months
2.	Source of water	river, lake, pond/tank	wells	rainfall (800 mm/year)	rainfall (800 mm/year)
3.	Climate	arid to humid	arid to humid	arid to semi-arid	sub humid to humid
4.	Irrigation	natural flow	lift irrigation	-no irrigation-	
5.	Water management	management of excess water	economical water use	water conservation	
6.	Fertilizer management	liberal use	liberal use	limited use	
7.	Objective	maximizing the yield	yield maximization	to get sustainable yield	
8.	Constraints	soil health, salt affected soils, drainage	salt affected soils	wind and water erosion	

The crop production is entirely different in dry farming and irrigated farming systems due to irrigation as given in Table 6.3.

Table 6.3. Difference between Dry Farming and Irrigated Farming

	<i>Dry farming</i>	<i>Irrigated farming</i>
1.	The field is ploughed deep to increase infiltration of rains.	No need of deep ploughing to conserve water.
2.	Land is prepared immediately after rainfall.	Land is prepared according to optimum time of sowing.
3.	Seeds are sown at more depth To make contact with moisture.	Seeds are sown at optimum depth.
4.	Crops or crop varieties having drought tolerance or less water requirement are used.	According to the need, crops or their varieties are selected.
5.	Generally, short duration crops.	Selection of crops depends on the need are preferred.
6.	Mixed inter cropping is beneficial.	Generally pure cropping is done.
7.	Due to limitation of moisture one or two crops in a year is possible.	More than 2 crops in a year are Grown, subject to the availability of water.
8.	Crop failure (risk) is expected.	No chance of crop failure (no risk).

Farming system

Farming systems represent an appropriate combination of farm enterprises *viz.*, cropping systems, livestock, fisheries, forestry, poultry and the means of available to the farmer to raise them for profitability. It interacts adequately with environment without dislocating the ecological and socio-economic balance on one hand and attempts to meet the national goal and others.

Terminologies

Opportunity farming - Yield or quality is taken into account. Profit is the deciding factor and not output.

Response farming - Maximum crop production (*i.e.*) output.

<i>Opportunity farming</i>	<i>Response farming</i>
5 t – IR 50 1 kg = Rs. 5/- It prevails most parts of India	2½ t – Basmati 1 kg = Rs. 25/- It is carried on in areas where only one and the same crop is raised

The details regarding different cropping systems and evaluation of cropping systems, and farming system are given in chapter 16.

Tillage operations in various forms have been practiced from the very inception of growing plants. Primitive man used tools to disturb the soils for placing seeds. The word tillage is derived from the Anglo-Saxon words *tilian* and *teolian*, meaning to plough and prepare soil for seed to sow, to cultivate and to raise crops. Jethrotull, who is considered as *Father of tillage* suggested that thorough ploughing is necessary so as to make the soil into fine particles.

7.0 DEFINITION

Tillage refers to the mechanical manipulation of the soil with tools and implements so as to create favourable soil conditions for better seed germination and subsequent growth of crops.

Tilth is a physical condition of the soil resulting from tillage. Tilth is a loose friable (mellow), airy, powdery, granular and crumbly condition of the soil with optimum moisture content suitable for working and germination or sprouting of seeds and propagules *i.e.*, tilth is the ideal seed bed.

7.1 CHARACTERISTICS OF GOOD TILTH

Good tilth refers to the favourable physical conditions for germination and growth of crops. Tilth indicates two properties of soil *viz.*, the size distribution of aggregates and mellowness or friability of soil. The relative proportion of different sized soil aggregates is known as size distribution of soil aggregates. Higher percentages of larger aggregates with a size above 5 mm in diameter are necessary for irrigated agriculture while higher percentage of smaller aggregates (1–2 mm in diameter) are desirable for rainfed agriculture. Mellowness or friability is that property of soil by which the clods when dry become more crumbly. A soil with good tilth is quite porous and has free drainage up to water table. The capillary and non-capillary pores should be in equal proportion so that sufficient amount of water and free air is retained respectively.

7.2 OBJECTIVES

Tillage is done:

- To prepare ideal seed bed favourable for seed germination, growth and establishment;
- To loosen the soil for easy root penetration and proliferation;
- To remove other sprouting materials in the soil;
- To control weeds;
- To certain extent to control pest and diseases which harbour in the soil;

- To improve soil physical conditions;
- To ensure adequate aeration in the root zone which in turn favour for microbial and biochemical activities;
- To modify soil temperature;
- To break hard soil pans and to improve drainage facility;
- To incorporate crop residues and organic matter left over;
- To conserve soil by minimizing the soil erosion;
- To conserve the soil moisture;
- To harvest efficiently the effective rain water;
- To assure the through mixing of manures, fertilizers and pesticides in the soil;
- To facilitate water infiltration and thus increasing the water holding capacity of the soil, and
- To level the field for efficient water management

7.3 TYPES OF TILTH

Fine Tilth refers to the powdery condition of the soil.

Coarse Tilth refers to the rough cloddy condition of the soil.

Fine seedbed is required for small seeded crops like ragi, onion, berseem, tobacco.

Coarse seedbed is needed for bold seeded crops like sorghum, cotton, chickpea, lab-lab etc.

7.4 TYPES OF TILLAGE

1. **On Season Tillage:** It is done during the cropping season (June–July or Sept.–Oct.).
2. **Off Season Tillage:** It is done during fallow or non-cropped season (summer).
3. **Special Types of Tillage:** It is done at any time with some special objective/purpose.

7.4.1 On Season Tillage

Tillage operations done for raising the crops in the same season or at the onset of the crop season are called as on season tillage. They are,

A. Preparatory Tillage

It refers to tillage operations that are done to prepare the field for raising crops. It is divided into three types *viz.*, (i) primary tillage, (ii) secondary tillage, and (iii) seed bed preparation.

- (i) **Primary tillage** - The first cutting and inverting of the soil that is done after the harvest of the crop or untilled fallow, is known as primary tillage. It is normally the deepest operation performed during the period between two crops. Depth may range from 10–30 cm. It includes ploughing to cut and invert the soil for further operation. It consists of deep opening and loosening the soil to bring out the desirable tilth. The main objective is to control weeds to incorporate crop stubbles and to restore soil structure.
- (ii) **Secondary tillage** - It refers to shallow tillage operation that is done after primary tillage to bring a good soil tilth. In this operation the soil is stirred and conditioned by breaking the clods and crust, closing of cracks and crevices that form on drying. Incorporation of manures and fertilizers, leveling, mulching, forming ridges and furrows are the main objectives. It includes cultivating, harrowing, pulverizing, raking, leveling and ridging operations.
- (iii) **Seed bed preparation** - It refers to a very shallow operation intended to prepare a seed bed or make the soil to suit for planting. Weed control and structural development of the soil are the objectives.

B. Inter Tillage/Inter Cultivation

It refers to shallow tillage operation done in the field after sowing or planting or prior to harvest of crop plants *i.e.*, tillage during the crop stand in the field. It includes inter cultivating, harrowing, hoeing, weeding, earthing up, forming ridges and furrows etc. Inter tillage helps to incorporate top dressed manures and fertilizers, to earth up and to prune roots.

7.4.2 Off Season Tillage

Tillage operation is done for conditioning the soil during uncropped season with the main objective of water conservation, leveling to the desirable grade, leaching to remove salts for soil reclamation reducing the population of pest and diseases in the soils. etc. They are:

- (a) **Stubble or Post harvest tillage** - Tillage operation carried out immediately after harvest of crop to clear off the weeds and crop residues and to restore the soil structure. Removing of stiff stubbles of sugarcane crop by turning and incorporating the trashes and weeds thus making the soil ready to store rain water etc., are the major objectives of such tillage operations.
- (b) **Summer tillage** - Operation being done during summer season in tropics to destroy weeds and soil borne pest and diseases, checking the soil erosion and retaining the rain water through summer showers. It affects the soil aggregates, soil organic matter and sometimes favour wind erosion. It is called as Kodai uzavu in Tamil Nadu state.
- (c) **Winter tillage** - It is practiced in temperate regions where the winter is severe that makes the field unfit for raising crops. Ploughing or harrowing is done in places where soil condition is optimum to destroy weeds and to improve the physical condition of the soil and also to incorporate plant residues.
- (d) **Fallow tillage** - It refers to the leaving of arable land uncropped for a season or seasons for various reasons. Tilled fallow represent an extreme condition of soil disturbance to eliminate all weeds and control soil borne pest etc. Fallow tilled soil is prone to erosion by wind and water and subsequently they become degraded and depleted.

7.4.3 Special Types

Special type tillage includes

- (i) **Subsoil tillage (sub soiling)** is done to cut open/break the subsoil hard pan or plough pan using sub soil plough/chisel plough. Here the soil is not inverted. Sub soiling is done once in 4–5 years, where heavy machinery is used for field operations and where there is a colossal loss of topsoil due to carelessness. To avoid closing of sub soil furrow vertical mulching is adopted.
- (ii) **Levelling by tillage** - Arable fields require a uniform distribution of water and plant nutrition for uniform crop growth. This is achieved when fields are kept fairly leveled. Levellers and scrapers are used for levelling operations. In leveled field soil erosion is restricted and other management practices become easy and uniform.
- (iii) **Wet tillage** - This refers to tillage done when the soil is in a saturated (anaerobic) condition. For example puddling for rice cultivation.
- (iv) **Strip tillage** - Ploughing is done as a narrow strip by mixing and tilling the soil leaving the remaining soil surface undisturbed.
- (v) **Clean tillage** - Refers to the working of the soil of the entire field in such a way no living plant is left undisturbed. It is practiced to control weeds, soil borne pathogen and pests.
- (vi) **Ridge tillage** - It refers to forming ridges by ridge former or ridge plough for the purpose of planting.

- (vii) **Conservation tillage** - It means any tillage system that reduces loss of soil or water relative to conventional tillage. It is often a form of non-inversion tillage that retains protective amounts of crop residue mulch on the surface. The important criteria of a conservation tillage system are: (i) presence of crop residue mulch, (ii) effective conservation of soil and water, (iii) improvement of soil structure and organic matter content, and (iv) maintenance of high and economic level of production (refer section 7.10 of this chapter).
- (viii) **Contour tillage** - It refers to tilling of the land along contours (contour means lines of uniform elevation) in order to reduce soil erosion and run off.
- (ix) **Blind tillage** - It refers to tillage done after seeding or planting the crop (in a sterile soils) either at the pre-emergence stage of the crop plants or while they are in the early stages of growth so that crop plants (cereals, tuber crops etc.) do not get damaged, but extra plants and broad leaved weeds are uprooted.

7.5 FACTORS AFFECTING (INTENSITY AND DEPTH OF) THE TILLAGE OPERATIONS

Several factors are responsible for deciding intensity and depth of tillage operations. They are soil type, crop and variety, type of farming, moisture status of the soil, climate and season, extent of weed infestation, irrigation methods, special needs and economic condition, and knowledge and experience of the farmer.

- (i) **Crop** - It decides the type, intensity and depth of tillage operations with small sized seeds like finger millet, tobacco etc. Require a fine seedbed which can provide intimate soil-seed contact as against coarser seed bed required for larger size seeds such as sorghum, maize, pulses, etc. Root or tuber crops require deep tillage whereas rice requires shallow puddling.
- (ii) **Soil type** - It dictates the time of ploughing. Light soils require early and rapid land preparation due to free drainage and low retentive capacity as against heavy soils.
- (iii) **Climate** - It influences soil moisture content, draught required tilling and the type of cultivation. Low rainfall and poor water retentive capacity of shallow soil do not permit deep ploughing at the start of the season. Heavy soils developing cracks during summer (self tilled) need only harrowing. Light soils of arid regions need coarse tilth to minimize wind erosion.
- (iv) **Type of farming** - It influences the intensity of land preparation. In dry lands, deep ploughing is necessary to eradicate perennial weeds and to conserve soil moisture. Repeated shallow tilling is adequate under such intensive cropping.
- (v) **Cropping system** - In involves different crops, which need different types of tillage. Crop following rice needs repeated preparatory tillage for obtaining an ideal seedbed. Crops following tuber crops like potato require minimum tillage. Similarly crops following pulses need lesser tillage than that of following sorghum, maize or sugarcane.

7.6 DEPTH OF PLOUGHING

Desirable ploughing depth is 12.5–20 cm. Ploughing depth varies with effective root zone depth of the crops. Ploughing depth is 10–20 cm to shallow rooted crops and 15–30 cm to deep-rooted crops. Deep ploughing is done to control perennial weeds like *Cyanodon dactylon* and to break soil hard pans. Since deep ploughing increases the cost, most farmers resort to shallow ploughing only.

7.7 NUMBER OF PLOUGHING

It depends on soil conditions, time available for cultivation between two crops, (turn over period) type

of cropping systems etc. Small or fine seeded crop requires fine tilth, which may require more ploughings. Zero tillage is practiced in rice fallow pulse crops or relay cropping system. Three numbers of puddling is sufficient for rice cultivation. Minimum numbers of ploughing are taken up at optimum moisture level to bring favourable tilth depending on the need of the crop and financial resources of the farmer. In fact, this brought the concept of minimal tillage or zero tillage systems.

7.8 TIME OF PLOUGHING

The time of ploughing is decided based on moisture status and type of soil. The optimum moisture content for tillage is 60% of field capacity. Ploughing at right moisture content is very important. Summer ploughing (March–May) can be practiced utilizing summer showers to control weeds and conserve soil moisture. Light soils can be worked under wide range of moisture. Loamy soils can be easily brought to good tilth. Pulverization of clay soils is difficult as they dry into hard clods.

7.9 METHOD OF PLOUGHING

Ploughing aims at stirring and disturbing the top layer of soil uniformly without leaving any unploughed strips of land. Straight and uniformly wide furrows give a neat appearance to the ploughed field. When the furrows are not straight or when the adjacent furrows are not uniformly spaced, narrow strips of land are left unploughed. The correct inter furrow space is little over the width of the furrow slice. After the harvest of a crop the land is first ploughed along the length of the field. This reduces the number of turns at the headlands for opening fresh furrows. The next ploughing is done across the field for breaking furrows of the previous ploughing. This must increase the turns at the headlands and the empty turns along the headlands, but is unavoidable. New turns are taken 6 m wide each time, till the entire field is covered.

7.10 MODERN CONCEPTS OF TILLAGE

In conventional tillage combined primary and secondary tillage operations are performed in preparing seed bed by using animal or tractor, which cause hard pan in sub soils resulting in poor infiltration of rain water, thus it is more susceptible to run off and soil erosion. Farmers usually prepare fine seed bed by repeated ploughing, when the animal of the farm is having less work. Research has shown that frequent tillage is rarely beneficial and often detrimental. Repeated use of heavy machinery destroys structures, causes soil pans and leads to soil erosion. Moreover energy is often wasted during tillage processes. All these reasons led to the development of modern concepts namely the practices like minimum tillage, zero tillage, stubble mulch farming and conservation tillage, etc.

7.10.1 Minimum Tillage

Minimum tillage is aimed at reducing tillage to the minimum necessary for ensuring a good seedbed, rapid germination, a satisfactory stand and favourable growing conditions. Tillage can be reduced in two ways by omitting operations, which do not give much benefit when compared to the cost, and by combining agricultural operations like seeding and fertilizer application.

(a) Advantages (especially in coarse and medium textured soils)

- Improved soil conditions due to decomposition of plant residues *in situ*.
- Higher infiltration caused by the vegetation present on the soil and channels formed by the decomposition of dead roots.
- Less resistance to root growth due to improved structure.

- Less soil compaction by the reduced movement of heavy tillage vehicles.
- Less soil erosion compared to conventional tillage.

(b) Disadvantages

- Seed germination is lower with minimum tillage.
- More nitrogen has to be added as the rate of decomposition of organic matter is slow. This point holds good only in temperate regions. Contrary to this in tropics, minimum tillage recommended to conserve organic matter in the soil.
- Nodulation is affected in some leguminous crops like peas and broad beans.
- Sowing operations are difficult with ordinary equipment.
- Continuous use of herbicides causes pollution problems and dominance of perennial problematic weeds (weed shift).
- Minimum tillage can be achieved by the following methods:
 - (a) **Row zone tillage** - Primary tillage is done with mould board plough in the entire area of the field, secondary tillage operations like discing and harrowing are reduced and done only in row zone.
 - (b) **Plough-plant tillage** - After the primary tillage a special planter is used for sowing. In one run over the field, the row zone is pulverized and seeds are sown by the planter.
 - (c) **Wheel track planting** - Primary ploughing is done as usual. Tractor is used for sowing, the wheels of the tractor pulverize the row zone in which planting is done.

7.10.2 Zero Tillage/No Tillage/Chemical Tillage

Zero tillage is an extreme form of minimum tillage. Primary tillage is completely avoided and secondary tillage is restricted to seedbed preparation in the row zone only. It is also known as no-tillage and is resorted to places where soils are subjected to wind and water erosion, timing of tillage operation is too difficult and requirements of energy and labour for tillage are also too high. Weeds are controlled using herbicides. Hence, it is also referred as chemical tillage. There are two types of zero tillage.

- (a) **Till Planting** is one method of practicing zero tillage. A wide sweep and trash bars clear a strip over the previous crop row and planter—opens a narrow strip into which seeds are planted and covered. In zero tillage, herbicide functions are extended. Before sowing, the vegetation present has to be destroyed for which broad spectrum non-selective herbicides with relatively short residual effect (Paraquat, Glyphosate etc.) are used and subsequently selective and persistent herbicides are needed (Atrazine, Alachlor etc.).
- (b) **Sod planting or sod culture:** Sod refers to top few centimeters of soil permeated by and held together with grass roots or grass-legume roots. Planting of seeds in sods without any tillage operation is known as sod culture or sod seeding. Usually legumes or small grains are mechanically placed directly into a sod.

Advantages

- Zero tilled soils are homogenous in structure with more number of earthworms. These soil physical properties are apparent after two years of zero tillage.
- The organic matter content increases due to less mineralization.
- Surface runoff is reduced due to the presence of mulch.

Disadvantages

- In temperate countries highest dose of nitrogen has to be applied for mineralization of organic matter in zero tillage.
- Large population of perennial weeds appears in zero tilled plots.
- Higher number of volunteer plants and build up of pests are the other problems.

7.10.3 Stubble Mulch Tillage or Stubble Mulch Farming

In this tillage, soil is protected at all times either by growing a crop or by leaving the crop residues on the surface during fallow periods. Sweeps or blades are generally used to cut the soil up to 12 to 15 cm depth in the first operation after harvest and the depth of cut is reduced during subsequent operations. When unusually large amount of residues are present, a disc type implement is used for the first operation to incorporate some of the residues into the soil.

Two methods are adopted for sowing crops in stubble mulch farming.

- Similar to zero tillage, a wide sweep and trash-bars are used to clear a strip and a narrow planter-shoe opens a narrow furrow into which seeds are placed.
- A narrow chisel of 5–10 cm width is worked through the soil at a depth of 15–30 cm leaving all plant residues on the surface. The chisel shatters tillage pans and surface crusts. Planting is done through residues with special planters.

Disadvantages

- The residues left on the surface interfere with seedbed preparation and sowing operations.
- The traditional tillage and sowing implements or equipments are not suitable under these conditions.

7.10.4 Conservation Tillage

Though it is similar to that of stubble mulch tillage, it is done to conserve soil and water by reducing their losses.

Modern tillage methods are practiced in western countries especially in USA. In India, it is not suitable due to several reasons. In USA, straw and stubbles are left over in the field but in India, it is a valuable fodder for the cattle and fuel for the home. Use of heavy machinery in India is limited and therefore, problem of soil compaction is rare. The type of minimum tillage that can be practiced in India is to reduce the number of ploughings to the minimum necessary *i.e.*, unnecessary repeated ploughings/harrowing can be avoided.

7.11 TILLAGE IMPLEMENTS

Any device used to carry on some work is called as implement. Implements are operated by animal power or by machinery. Implements are classified into primary, secondary and intercultural, depending on the purpose for which it is being used.

7.11.1 Primary Tillage Implements

Primary tillage is the deepest operations/performed during the period between two crops. The following are the implements used for primary tillage.

1. **Country/wooden/Desi plough** - The indigenous plough consists of a wooden body to which a handle and a shaft pole are attached. The body is made of a bent piece of hard wood with two arms making an angle of about 135°. It is given a wedge shape with an isosceles triangular section. A small piece of flat iron (shares) serves as the piercing point of the plough and is fixed

over the plough body with clamps. The shaft pole is secured with the yoke during working. The working of plough results in the opening of 'V' shaped furrow. The width of furrow depends on the size of the plough bottom. The depth of penetration of a country plough can be altered a little by pulling the implement behind or pushing forward, which results in deeper or shallow ploughings respectively. It covers 0.15 to 0.20 hectare in 8 hours.

2. **Improved iron plough** - The bullock drawn improved iron plough is made of mild steel except the pole shaft and hence it has longer life. As and when the share wears off, it can be pushed forward. Pole shaft angle and height of the handle can be adjusted according to field requirements. The plough is provided with a mould board as optional attachment for soil inversion. This plough is suitable for dry ploughing in all types of soil with a pair of bullocks. It covers 0.5 ha per day and costs Rs. 750-1000/-.
3. **Bose plough** - It is wooden plough with a mould board can share instead of the usual small iron share. It is used for the primary tillage operations in wetlands. Nowadays this plough is made up of iron angles instead of woods to make it sturdy. It is also called as **Melur plough** in Tamil Nadu.
4. **Mould board plough** - It is a modern tillage implement used to plough deeply and pulverize the soil. It is more durable, easy to pull and can be adjusted properly. The main parts of the mould board plough are the frog or body, handle, beam, share, mould board, wheel and coulter. This type of plough leaves no unploughed land as the furrow slices are cut clean and inverted to one side resulting in better pulverization. The animal drawn mould board plough is small, ploughs to a depth of 15 cm. Big size tractor drawn mould board ploughs can plough up to a depth of 30 cm. Mould board ploughs are used when soil inversion is necessary. Victory plough is an animal drawn mould board plough with a short shaft.
5. **Turn wrest plough** - This is also called reversible plough. The mould board with share is hinged either left or right side of the central body with a hook. When the mould board is needed to shift to another side, the hook is released and the mould board is easily swing to the opposite side. By this when the plough reaches to one end of the land instead the mould board can be shifted



Fig. 7.1 Ploughing with country plough



Fig. 7.2 Rotavator



Fig. 7.2a Tractor operated rotavator

to other side and the ploughing can be continued, so that furrow slices will uniformly fall and same direction.

6. **Disc plough** - In the disc plough, the share, the mould board and coulter of the mould board plough are replaced by an inclined concave steel disc of 60-90 cm diameter, set at an angle to the direction of travel. Each disc revolves on an axle and the angle of the disc to the vertical position and to the furrow wall is adjustable. Lever arrangements are provided to lift the discs clear off the ground and for changing the angle of molding and adjusting the depth of penetration of the discs into the soil. While working, the discs rotate, scoop out furrows, invert the furrow slice and pulverize them thoroughly. Disc plough is especially useful under the following soil conditions: Soil with hard pan and sticky soil, Dry hard ground, Rough and stony ground, Ploughing weedy lands and lands with stubbles, Deep ploughing.



Fig. 7.3 Mould board plough



Fig. 7.3a Disc plough

7. **Reversible disc plough** - It is constructed in such a way that the disc can be reversed and the soil is thrown on one side. The land and furrow wheel adjust themselves properly when the plough is reversed. Reversible disc plough saves time taken up by ordinary disc plough. The furrow slice cut at each trip by the reversible disc plough is laid over the previous furrow thus resulting in a leveled field after ploughing.
8. **Chisel plough or subsoil plough** - It is bullock drawn implement used to break hardpan that exists in the soil due to continuous same type of operation. It consists of a curved chisel "C" like tyne with 37 cm radius of curvature and 3 cm thickness. It is rigidly held in a frame, which is provided with a handle and a shaft pole. The operation of this plough is the same as that of an ordinary plough. It makes a simple vertical cut in the sub soil up to a depth of 45 cm and facilitates the downward movement of water and sub soil drainage. Chiseling becomes necessary in soil with hard impermeable plough pan. Both animal drawn (coverage 2 ha/day) costs Rs. 1200/- and tractor drawn (coverage 5 ha/day) costs Rs. 6000/- are available for usage.

7.11.2 Secondary Tillage Implements

Secondary tillage is the shallow operation performed after the primary tillage. Secondary tillage implements are used for breaking clods and producing a loose, friable, smooth state. These implements are used with the following objectives.

- Breaking the furrow slice and working the soil to get the required tilth
- Destruction of weeds
- Stirring the soil and forming mulch

- Mixing the manures and fertilizers with soil
- Covering the seeds

1. **Cultivators** - These implements have number of tines for piercing the soil and breaking clods. Tines of 23–30 cm long are fixed to a heavy and sturdy, frame, mounted on wheels. These tines penetrate up to a depth of 20 cm in heavy models. Cultivators are used when the soil is ploughed deep with heavy mould board ploughs to break the big clods that are formed.



Fig. 7.4 Cultivator



Fig. 7.4a Disc harrow

2. **Harrows** - They are smaller implements with many tines like cultivators. Used for breaking smaller clods left unbroken by cultivators and for producing a powdery seedbed. Tines are set closer (5-8 cm) and are smaller in size. They penetrate up to about 10 cm depth. There are different types of harrows in use.
 - A. **Spike tooth harrow** - Peg like steel tines of round, oval, square, triangular or rhomboid section are fixed on a rigid or flexible frames for use under different soil conditions. Rhomboid section offers straight cutting edge and it enters the soil properly and is better than others. In undulating lands the flexible types adjust themselves to the uneven surface. When the frame is of a zigzag type it called zigzag harrow.
 - B. **Spring tine harrow** - Instead of rigid tines strong steel springs shaped like the letter “C” are attached to the frame. Depth of penetration is adjusted with lever arrangements. Tines ride over rocky and other obstructions in the field and are not damaged since the spring tines recoil on obstruction. Due to vibration they pulverize clods better than rigid types.
 - C. **Chain harrow** - Number of stout steel links is connected together to spread over the soil like a mat. Links may have spike like projections. Since, they are flexible they adjust unevenness of the surface. These harrows are used for breaking clods and making the surface smooth and even. It can also be used for covering seeds after broadcasting.
 - D. **Disc harrow** - These harrows are made up of number of concave discs of 46–56 cm in diameter, fitted 15 cm apart on square axles. Two sets of discs are mounted on different axles. Discs cut through the soil and effectively pulverize clods. Small animal drawn harrows have six discs and power driven harrows have larger number.
 - E. **Intercultivating harrow** - Different types of harrows are used for intercultivation. Tines pass through the inter row spaces and effectively remove the weeds. The typical example of the intercultivating harrow is *junior hoe*.

Different attachments can be made in the tines of the junior hoe to make use of same harrow for different purposes.

Sweeps are blades that move horizontally under the soil and cut the shallow rooted weeds. There are two kinds of sweeps. The **Central sweep** attached to the central tines has horizontal wings extending on both the sides. The **One side sweep** has the wing on the right or left side. On the side tines, one-sided sweeps are fixed on the side away from the crop rows.

Hiller is a rhomboidal curved steel plate, shaped like the mould board, which is used for earthing up crop rows.

Furrows have a double mould board one on either side, which splits the furrow slice and lays it on both sides equally. It is used with a central tine to open the furrow for sowing or to clean the furrow for irrigation.

Cultivator steel is a steel plate with sharp edge, which penetrates into the soil.

- F. **Blade Harrows** - Different from conventional harrows in that there are no tines but they are fixed with horizontal blades, which enter into the soil and travel below the surface at a constant depth. These blades sever (cut) the surface layer from the soil below and leaves it in its original position with slight disturbance to the surface soil. These harrows cut the weeds, eradicate all weeds except those, which have under ground bulbs.

The Guntaka is the blade harrow used for primary tillage in ceded districts of Andhra Pradesh. It has a horizontal wooden beam of 15 cm diameter with a fixed handle, shaft pole and blade. The blade is fixed to the beam near the ends by two standards at 25 cm distance from beam. The blade is 1.0 m long, 7.5 cm broad and 1.25 cm thick, with a cutting edge in front. Big sized guntakas are called as *bara guntakas* (1.8 m long blade). Small guntakas with 15 to 33 cm long blades are called as *danties* that are used for inter cultivation in crops, spaced at 28–46 cm apart. Since they are small, five or six danties are attached to a common yoke and guided by three or four people. It covers 0.4 ha/day of eight hours.

7.11.3 Inter Cultural Implements

- (i) **Japanese rotary weeder** - It consists of two small-toothed rollers or drums mounted on a frame provided with handle. Each roller consists of about 5-toothed blades. This implement, while working is pushed and pulled alternatively by the operator in between rows of rice crop. The float provided will guide the implements smoothly while working and prevent the implement sinking into the puddle. The weeder is used to bury the weeds into the mud so as to decompose them add organic matter to the soil, sufficient for working this implement.
 - (ii) **Conoweeder** - It is also similar to rotary weeder in which instead of two toothed rollers or drums two toothed cones are mounted on a frame provided with handle. This implement while working is pushed and pulled alternatively by the operation in between rows of rice crop. The float provided will guide the implement smoothly while working and prevent the implement from sinking.
 - (iii) **Long-handled weeders** - Long handled weeders are used for weeding in row crops for removing shallow rooted weeds. Useful in dry land and garden land crops when the soil moisture content is 8–10 percent. They are manually operated. One-man labour covers 0.05 ha/day. It costs Rs. 350/-.
- (a) **Peg tooth type** - It is a long handled tool consists of two numbers of 2.5 cm diameter, 120 cm long pipes over which 52 cm long handled is fitted. To the bottom of the vertical pipe frames, two arms made of 25 × 2.5 × 0.3 cm MS plates are fitted. At the extreme end of the arm, peg wheel is placed. The blade can be adjusted to the desired angle and depth. The peg teeth permit the movement of the roller in clay soil without getting clogged.

- (b) **Star wheel type** - It is similar to the peg type weeder excepting that the star type roller facilitates easier operation of the weeders in loamy and sandy soils.

7.11.4 Special Purpose Implements

Implements that are used for a specific purpose other than primary or secondary and intercultural tillage are called as special purpose implements. The following are some of them.

7.11.4.1 Multipurpose tool bar/carrier

The multipurpose tool carrier is used for primary, secondary and intercultural operations, forming bunds, ridges and furrows and for sowing crops in rows. It is suitable for all soils. A multipurpose tool carrier is made up to G.I. tube, which has the provision to attach cultivators (4 Nos.), ploughs (3 Nos.), ridger (2 Nos.), seed drill (4 Nos.) and bund formers (2 Nos.). The spacing between rows is adjustable. The field capacity of plough is 1.2 ha/day, while for cultivator and ridger, it is about 0.74 ha/day.

7.11.4.2 Land leveling implements

- (a) **Buck scraper** - It is a bullock-drawn implement made up of steel sheets like an open box with a bottom and three sides; the fourth side is left open. Two flat steel runners are provided at the bottom to protect the base and prevent the steel plate from being worn-out while leveling. Two handles are fixed at the sides for assisting in filling the box with earth and for emptying the contents. The drawbar is attached to the sides with hinge arrangement. It is a bullock drawn implement very useful to carry the soil to a long distance while levelling.
- (b) **Levelling board** - It is a channel like or trapezoidal shaped wooden board with 2-2.75 m length and 20 cm diameter. It is attached to the shaft pole with a hinged hook. It is used for levelling rice fields after the final ploughing to facilitate uniform seed germination. When the operator stands over the board; it sinks lightly into the loose mud and when it moves, the soil in front of it is also moved, but is released when he gets down.
- (c) **Wooden float** - It is a bullock drawn implement with a long sledge-like drag used for land smothering. By working the field with wooden float three or four times lengthwise, crosswise and diagonally the field is smoothen in a better way.

7.11.4.3 Land shaping implements

- (a) **Ridge plough** - It is a bullock or tractor drawn implement. It is a double mould board plough with mould boards on both the sides, which meet along a central line. The mould boards are either fixed or adjustable so that the width of the furrow can be adjusted. The ridge plough lays the earth on both the sides equally, leaving an open furrow in the middle. It forms furrows and not ridges. However, when the furrows are close to one another; the inter furrow spaces take the form of ridges but when furrows are formed apart for planting sugarcane, cotton, etc., the inter furrow spaces take the form of ridges but when furrows are formed apart for planting sugarcane, cotton, etc., the inter-furrow spaces take the form of raised flat beds.
- (b) **Bund former** - This consists of a pair of opposing wings, which are wide apart in front and converge towards the rear with a gap at the end. The wings gather loose soil from the surface and leave it in the form of bund with approximately 18-20 cm in height. To form reduced size bunds, the wings are lightly raised at the fore end and pulled a little backward. When the implement is hitched near the yoke, a small quantity of earth alone is gathered. The gaps formed at the intersection of long and cross bunds while working with the implement are closed with manual labour. Ridges for sowing cotton and similar crops are also formed with bund former, with the bunds close to one another as when irrigation channels are formed.

- (c) **Bed-furrow former** - It is a tractor-drawn iron implement, which is capable of forming alternate beds and channels. It will form two beds and three furrows in one pass of unit. Using this implement a well defined, raised beds 30 cm wide at top and 'V' shaped channels 45 cm wide and 15 cm deep are formed on the well-ploughed and harrowed field. It covers an area of 3–3.5 ha/day.
- (d) **Rollers** - The rollers are used for breaking clods and compacting the soil. There are different types of rollers in use.
- (i) In *Iron rollers* cast iron rings of 0.6 m in diameter are fixed to an axle and provided with a hopped frame for hitching with power unit. Surface of the roller may be plain or fluted or ribbed. The fluted and ribbed rollers are more efficient in breaking clods. The plain rollers are used for compacting the soil surface.
 - (ii) *Stone rollers* are commonly used for threshing grains. They are made up of cylindrical stone with 0.75 m length and 0.4 m diameter.
 - (iii) *Sheep foot roller* is the latest implement developed by TNAU, to create partial compaction in rice fields in light soils. It has a cylindrical drum with projections on the surface like sheep foot.

7.11.4.4 Sowing implements

- (a) **Country seed drill/'Gorru'** - It consists of a horizontal beam on which a number of tines are fixed at suitable distances. The tine is like the body of the common wooden plough, but is much smaller. It has a vertical hole, a little above the point of penetration into the soil. Seeds are released from the above placed seed hoppers steadily few seeds at a time. The base of the hopper has as many holes as there are tines in the gorru and narrow bamboo or metal tubes connect the hopper and the tines. This enables the seeds released in the hopper being dropped in the furrows opened by the tines. The hopper and the seed tubes are held in position with thin ropes.
- (b) **Mechanical seed drills** - It is of both bullock and tractor drawn.
- (i) *Bullock drawn seed drill/TNAU improved planter* - A medium size five tined cup feed seed drill suitable for heavy size bullocks, a small three tined cup feed seed drill called as *Kovai seed drill* are suitable for small pair of bullocks. These drills are suitable for sowing seeds of groundnut, maize, sorghum, cotton, Bengal gram and pulses. It covers on ha per day and costs Rs. 3,500/-.
 - (ii) *Tractor drawn seed drill* - Both simultaneous formation of 1.5 m wide beds and sowing in the bed is possible using this drill. The implement consists of a pair of furrowers made of sheet metal with suitable hitching arrangements to the three-point linkage of the tractor. Over the framework of these furrowers 7 numbers of hoppers with metering mechanisms have been mounted. This implement simultaneously sows in seven rows in the broad bed. It covers an area of 4 ha/day and saves 25% of sowing cost.
 - (iii) *Rice drum seeder for wetland (Drum seeder for direct sowing of rice)* - A manually pulled, rice seeder has been developed at TNAU for sowing pregerminated rice seeds in rows directly in well puddled and leveled soil. It requires 2 labourers and covers 0.4 ha/day. Using this seeder green manures (*Sesbania sp.*) can also be sown as intercrop in between rice rows. Cost of this seeder is Rs. 3000/-.

7.11.4.5 Implements for wetlands

Under wetland system the land is prepared by puddling for planting wet rice. Puddling means mechanical manipulation of saturated soils with standing water in the field. Actually the structure of the

soil is destroyed under puddling. The optimum depth of puddling is about 10 cm in the clay and clay-loam types of soils. Good puddling or neatly ploughed means the soil should be soft, uniformly leveled without weeds or stubbles and with minimum percolation.

A. Why puddling?

Puddling is done

- To obtain a soft seedbed for the seedling to establish faster,
- To minimize percolation of water so that water can stagnate in the field,
- To minimize leaching loss of nutrients and thereby increase the availability of plant nutrients,
- To facilitate better availability of nutrient by achieving reduced soil condition,
- To incorporate the weeds and stubbles into the soils, and
- To minimize the weed problems

The implements used for puddling the wet soils are as follows:

(i) Country plough, (ii) Bose plough, (iii) Wetland puddler, (iv) Cage wheel, (v) Sheep foot roller, and (vi) Helical bladed puddler.

(i), (ii) and (v) were discussed already in this chapter.

(iii) **Wetland puddler** - It consists of three angular bladed cast iron hoods rigidly fixed to a hollow horizontal pipe and is rotated when dragged by a pair of bullocks. This implement is proved to be an economic, labour saving and an effective dual-purpose implement useful for puddling and trampling green leaf manure in the puddle field. When used for trampling the vegetative matter is cut and buried in the soil. It covers an area of 0.8 ha/day.

(iv) **Cage wheel** - It is used for puddling in medium and heavy clayey soils in wetlands for rice cultivation. The cage wheels are attached in place of pneumatic wheels in power tiller and tractor. The cage wheels perform well in all the fields except in fields with clay and silt content of the soil was more than 56%. It saves cost, time and brings more uniformity and thoroughness in the puddle than country ploughing. Cage wheel attached to power tiller covers an area of 0.44 ha/day. The average depth of puddle is 23 cm.

(vi) **Helical bladed puddler** - It is used to puddle the wetland soil after initial ploughing with country plough or melur plough. It is a bullock-drawn implement. Five numbers of helical blades made of mild steel are fixed in a skewed shape and mounted on a wooden frame having wooden bearing such that the blades can rotate freely. A handle and pole shaft are provided. Due to the helical shape of the blade, there will be continuous contact between the blades and the soil, which gives uniform load on the neck of the bullocks. After ploughing the land with country plough, the implement can be used to puddle the soil up to a depth of 10 cm. The helical geometry facilitates better churning and slicing of the soil required for puddling. It covers 0.6 ha/day.



Fig. 7.5 Main field preparation using power tiller operated cage wheel

Seeds and Sowing

Plants reproduce sexually by seeds and asexually by vegetative parts. Grains, which are used for multiplication, are called seeds while those used for human or animal consumption are called grains. Good stalks of planting materials are basic to profitable crop production. The seed or planting material largely determines the quality and quantity of the produce. A good seed or stalk of planting material is genetically satisfactory and true to type, fully developed and free from contamination, deformities, diseases and pests.

Seed is a fertilized ripened ovule consisting of three main parts namely seed coat, endosperm and embryo, which in due course gives raise to a new plant. Endosperm is the storage organ for food substance that nourishes the embryo during its development. Seed coat is the outer cover that protects or shields the embryo and endosperm.

8.1 CHARACTERISTICS

A good quality seed should possess the following characteristics.

- Seed must be true to its type *i.e.*, genetically pure, free from admixtures and should belong to the proper variety or strain of the crop and their duration should be according to agroclimate and cropping system of the locality.
- Seed should be pure, viable, vigorous and have high yielding potential.
- Seed should be free from seed borne diseases and pest infection.
- Seed should be clean; free from weed seeds or any inert materials.
- Seed should be in whole and not broken or damaged; crushed or peeled off; half filled and half rotten.
- Seed should meet the prescribed uniform size and weight.
- Seed should be as fresh as possible or of the proper age.
- Seed should contain optimum amount of moisture (8-12%).
- Seed should have high germination percentage (more than 80%).
- Seed should germinate rapidly and uniformly when sown.

8.2 ADVANTAGES OF USING GOOD QUALITY SEEDS

The following are the advantages of using good quality seeds.

- Reduced cost of cleaning, standardization and disinfections.

- Uniform germination thus avoiding replanting, gap filling.
- Vigorous seedling growth, which reduces weed and disease, damages.
- Uniform growth stages, maturity and products.
- Maintain good quality under storage conditions.
- Reduced cost.

8.3 SEED GERMINATION

Germination is a protrusion of radicle or seedling emergence. Germination results in rupture of the seed coat and emergence of seedling from embryonic axis. Factors affecting germination are soil, environment, water, temperature, light, atmospheric gases and exogenous chemicals required for germination of seeds.

Factors affecting

Soil: Soil type, texture, structure and microorganism greatly influence the seed germination.

Environment: Generally, the environmental conditions favouring growth of seedling also favours germination. Germination does not occur until the seeds attain physiological maturity.

Water (soil moisture and seed moisture): Imbibitions of water is the prerequisite process for germination. Both living and dead seeds imbibe water and swell. Dead seeds imbibe more water and swell rapidly as compared to good seeds. The amount imbibed is related to the chemical composition of the seed such as proteins, mucilage's pectins and biochemical components. Cereal grains such as maize imbibe water to approximately 1/3 of its seed weight, soybean seeds to 1/2 of its seed weight. Seed germination will be maximum when the soil moisture level is at field capacity. Slower rate of germination is noticed in places where soil moisture is near or at wilting point.

Temperature: The cardinal temperature (Maximum, optimum and minimum temperature) for germination of some of the crops is given below; The optimum temperature is that one gives the highest germination percentage in the shortest period of time.

Table 8.1. Cardinal Temperature for important Crops

	<i>Minimum °C</i>	<i>Optimum °C</i>	<i>Maximum °C</i>
Maize	8–10	20–25	30–35
Rice	10–12	20–27	30–32
Wheat	3–5	15–31	33

Light: The most effective wavelength for promoting and inhibiting seed germination is red (660 nm) and infrared (730 nm), respectively.

Atmospheric gases: Most crop seeds germinate well in the ambient composition of air with 20% O₂, 0.03% CO₂ and 78.2% N.

Exogenous chemicals: Some chemicals induce or favour quick and rapid germination.

- Gibberellins stimulate germination in protoplasmic seeds.
- Hydrogen peroxide (H₂O₂) is used for legumes, tomato and barley.
- Ethylene (C₂H₄) is used for stimulating groundnut germination.

8.4 SEED RATE

Seed rate is the quantity of seed required for sowing or planting in an unit area. The seed rate for a particular crop would depend not only on its seed size/test weight, but also on its desired population, germination percentage and purity percentage of seed. It is calculated as follows:

$$\text{Seed rate (kg)} = \frac{\text{Area to be sown in m}^2 \times \text{Test weight of the seed} \times 1}{\text{Germination \%} \times \text{Purity \%} \times \text{Spacing (m)} \times 1000}$$

8.5 SEED TREATMENT

Seed treatment is a process of application either by mixing or by coating or by soaking in solutions of chemicals or protectants (with fungicidal, insecticidal, bactericidal, nematocidal or biopesticidal properties), nutrients, hormones or growth regulators or subjected to a process of wetting and drying or subjected to reduce, control or repel disease organisms, insects or other pests which attack seeds or seedlings growing there from. Seed treatment also includes control of pests when the seed is in storage and after it has been sown/planted.

The seed treatment is done for the following reasons;

- To protect from seed borne pests and diseases.
- To protect from or repel birds and rodents.
- To supply plant nutrients.
- To inoculate microorganisms.
- To supply growth regulators.
- To supply selective herbicides.
- To break seed dormancy.
- To induce drought tolerance.
- To induce higher germination percentage, early emergence.
- To obtain polyploids (genetic variation) by treating with x-rays, gamma rays and colchicines.
- To facilitate mechanized sowing.

8.5.1 Methods of Seed Treatment

1. **Dry treatment:** Mixing of seed with powder form of pesticides/nutrients.
2. **Wet treatment:** Soaking of seed in pesticide/nutrient solutions
3. **Slurry treatment:** Dipping of seeds/seedlings in slurry. Example—rice seedlings are dipped in phosphate slurry.
4. **Pelleting:** It is the coating of solid materials in sufficient quantities to make the seeds larger, heavier and to appear uniform in size for sowing with seed drills. Pelleting with pesticides as a protectant against soil organisms, soil pests and as a repellent against birds and rodents.

The seed treatment for different field crops is given in chapter 15.

8.6 SOWING

Sowing is the placing of a specific quantity of seeds in the soil for germination and growth while planting is the placing of plant propagules (may be seedlings, cuttings, rhizomes, clones, tubers etc.) in the soil to grow as plants.

8.6.1 Methods of Sowing

Seeds are sown directly in the field (seed bed) or in the nursery (nursery bed) where seedlings are raised and transplanted later. Direct seeding may be done by

- | | |
|------------------|--------------------------------------|
| (a) Broadcasting | (b) Dibbling |
| (c) Drilling | (d) Sowing behind the country plough |
| (e) Planting | (f) Transplanting |

- (a) **Broad casting** - Broad casting is the scattering or spreading of the seeds on the soil, which may or may not be incorporated into the soil. Broadcasting of seeds may be done by hand, mechanical spreader or aeroplane. Broadcasting is the easy, quick and cheap method of seeding. The difficulties observed in broadcasting are uneven distribution, improper placement of seeds and less soil cover and compaction. As all the seeds are not placed in uniform density and depth, there is no uniformity of germination, seedling vigour and establishment. It is mostly suited for closely spaced and small seeded crops.
- (b) **Dibbling** - It is the placing of seeds in a hole or pit made at a predetermined spacing and depth with a dibbler or planter or very often by hand. Dibbling is laborious, time consuming and expensive compared to broadcasting, but it requires less seeds and, gives rapid and uniform germination with good seedling vigour.
- (c) **Drilling** - It is a practice of dropping seeds in a definite depth, covered with soil and compacted. Sowing implements like seed drill or seed cum fertilizer drill are used. Manures, fertilizers, soil amendments, pesticides, etc. may be applied along with seeds. Seeds are drilled continuously or at regular intervals in rows. It requires more time, energy and cost, but maintains uniform population per unit area. Rows are set according to the requirements.
- (d) **Sowing behind the country plough** - It is an operation in which seeds are placed in the plough furrow either continuously or at required spacing by a man working behind a plough. When the plough takes the next adjacent furrow, the seeds in the previous furrow are closed by the soil closing the furrow. Depth of sowing is adjusted by adjusting the depth of the plough furrow. e.g., ground nut sowing in dry land areas of Tamil Nadu.
- (e) **Planting** - Placing seeds or seed material firmly in the soil to grow.
- (f) **Transplanting** - Planting seedlings in the main field after pulling out from the nursery. It is done to reduce the main field duration of the crops facilitating to grow more number of crops in an year. It is easy to give extra care for tender seedlings. For small seeded crops like rice and ragi which require shallow sowing and frequent irrigation for proper germination, raising nursery is the easiest way.

Pre-monsoon sowing

Normally, sowing is taken up after receipt of sufficient amount of rainfall (20 mm) in the case of dry land farming. Since sowing is continued for two or three days after a soaking rain, certain amount of moisture is last during the period between the receipt of rainfall and sowing. In the case of heavy clay soils (black soils), sowing operation is difficult after the receipt of rain. To overcome this difficulty, sowing is taken up in dry soil prepared with summer rains, 7-10 days before the anticipated receipt of sowing rains. The seeds germinate after the receipt of the rainfall. This method of sowing is known as dry sowing or pre-monsoon sowing. By this method, the entire rainfall received is efficiently utilized.

8.6.2 Factors involved in Sowing Management

This can be classified into two broad groups.

1. **Mechanical factors** - Factors such as depth of sowing, emergence habit, seed size and weight, seedbed texture, seed–soil contact, seedbed fertility, soil moisture etc.

- (i) **Seed size and weight:** Heavy and bold seeds produce vigorous seedlings. Application of fertilizer to bold seed tends to encourage the seedlings than the seedlings from small seeds.
- (ii) **Depth of sowing:** Optimum depth of sowing ranges from 2.5–3 cm. Depth of sowing depends on seed size and availability of soil moisture. Deeper sowing delays field emergence and thus delays crop duration. Deeper sowing sometimes ensures crop survival under adverse weather and soil conditions mostly in dry lands.
- (iii) **Emergence habit:** Hypogeal seedlings may emerge from a relatively deeper layer than epigeal seedlings of similar seed size.
- (iv) **Seedbed texture:** Soil texture should minimize crust formation and maximize aeration, which in turn influence the gases, temperature and water content of the soil. Very fine soil may not maintain adequate temperature and water holding capacity.
- (v) **Seeds–Soil contact:** Seeds require close contact with soil particles to ensure that water can be absorbed readily. A tilled soil makes the contact easier. Forming the soil around the seed (broadcasted seeds) after sowing improves the soil–seed contact.
- (vi) **Seedbed fertility:** Tillering crops like rice, ragi, bajra etc., should be sown thinly on fertile soils and more densely on poor soils. Similarly high seed rate is used on poor soil for non-tillering crops. Although higher the seed rate greater the yield under conditions of low soil fertility, in some cases such as cotton, a lower seed rate gives better result than a higher seed rate.
- (vii) **Soil moisture:** Excess moisture in soil retards germination and induce rotting and damping off disease except in swamp (deep water) rice. Adjustment in depth is made according to moisture conditions, *i.e.*, deeper sowing on dry soils and shallow sowing on wet soils. Sowing on ridges is usually recommended on poorly drained soils.

2. **Biological factors** - Factors like companion crops, competition for light, soil microorganisms etc.

- (i) **Companion crop:** Companion crop is usually sown early to suppress weed growth and control soil erosion. In cassava + maize/yam cropping, cassava is planted later in yam or maize to minimize the effect of competition for light. In mixed cropping, all the crops are sown at the same time.
- (ii) **Competition of light:** In mixed stands, optimum spacing for each crop minimizes the competition of light.
- (iii) **Soil microorganisms:** The microorganisms present in the soil should favour seed germination and should not possess any harmful effect on seeds/emerging seedlings.

Plant Density and Crop Geometry

Plant density is the number of plants per unit area in a cropped field. It indicates the size of the area available for individual plant.

Crop geometry is the pattern of distribution of plant over the ground or the shape of the area available to the individual plant, in a crop field.

9.1 IMPORTANCE

Yield of a crop depends on the final plant density. The density depends on the germination percentage and the survival rate in the field. Establishment of required plant density is essential to get maximum yield. For example when a crop is raised on stored soil moisture under rainfed conditions, high density will deplete moisture before crop maturity. Where as, low density will leave moisture unutilized. Hence, optimum density will lead to effective utilization of soil moisture, nutrients, sunlight etc. When soil moisture and nutrients are not limited, higher density is necessary to utilize other growth factors (solar radiation) efficiency. When maximum yield per plant. On the contrary when the density is more, individual plant gets narrow space leading to competition for growth factors between plants resulting in reduction of yield per plant.

Yield per plant decreases gradually as plant density per unit area is increased as shown in the. However, the yield per unit area is increased up to a certain level of plant density due to utilization of growth factors. Maximum yield per unit area can, therefore, be obtained when the plant density is optimum.

(a) Plant Density and Yield

Biological yield increases with increases in plant density up to a point and reaches a plateau with further increase in density, thus no additional biological yield can be obtained. On the other hand, the economic yield increases with increase in plant density up to a point and subsequently decreases with increased in density.

(b) Plant Density and Growth

Plant height increase with increase in plant density due to competition for light. Dense plant stands leads to reduction in leaf thickness and alters leaf orientation. Dry matter production per unit area increase with increase in plant density up to a limit, as in biological yield.

9.2 FACTORS AFFECTING PLANT DENSITY

Optimum plant density is necessary to obtain maximum yield. Optimum plant density depends on size

of the plant, elasticity, foraging area, nature of the plant, capacity to reach optimum leaf area at an early date and seed rate used. The factors affecting plant density are grouped into two as (a) genetic and (b) environment factors.

A. Genetic Factors (plant or internal factors)

- (i) **Size of plant** - The volume occupied by the plant at the time of flowering decides the spacing of the crop. Plants of red gram, cotton, sugarcane etc., occupy larger volume of space in the field compared to rice, wheat, ragi, etc. Even the varieties of the same crop differ in size of plant.
- (ii) **Elasticity of the plant** - Variation in size of plant between the minimum size of the plant that can produce some economic yield to the maximum size of the plant that can reach under unlimited space and resources is the elasticity of the plant. The optimum plant density range is high in indeterminate plants. For example, in indeterminate red gram varieties the optimum plant density ranges from 55 to 133 thousand plants/ha. The elasticity of plants is due to branching or tillering. For determinate plants like maize, sorghum etc., the elasticity is less and hence the optimum plant density range is small. The removal of auxiliary buds is done to get uniform and early maturity in castor.
- (iii) **Foraging area or soil cover** - The crop should cover the soil as early as possible so as to intercept maximum sunlight. More interception of solar radiation leads to more dry matter production. Closely spaced plants intercept more radiation than widely spaced plants. Area of root spread also decides the density.
- (iv) **Dry matter partitioning** - Dry matter production is related to the amount of solar radiation intercepted by the canopy, which depends on the plant density. As the plant density increases, the canopy expands more rapidly, more radiation is intercepted and more dry matter is produced.

B. Environmental Factors (management factors)

The primary management factor affecting the plant density of any crop varieties is the method of stand establishment/sowings like transplanting or broadcasting. For transplanting/direct drilling, the genetic factors are the deciding factors on the number of plants per unit area. For broadcasting, the factors are:

- (i) **Time of sowing** - The crop is subjected to different weather conditions when sown at different periods. Among the weather factors, the most important factors that influence optimum plant density are day length and temperature. Photosensitive varieties respond to day length resulting in change in size of the plant. As low temperature retards the growth, higher density is established for quicker ground cover.
- (ii) **Rainfall/irrigation** - Plant density has to be less under rainfed than irrigated conditions. Under higher plant densities, more water is lost through transpiration. Under adequate irrigation or under evenly distributed rainfall conditions, higher plant density is recommended.
- (iii) **Fertilizer application** - Higher plant density is necessary to fully utilize higher level of nutrients in the soil to realize higher yield. Nutrient uptake increases with increase in plant density. Higher density under low fertility conditions leads to development of nutrient deficiency symptoms. For example, rice does not respond to plant density without nitrogen application.
- (iv) **Seed rate** - Quantity of seed sown/unit area, viability and establishment rate decides the plant density.

9.3 CROP GEOMETRY

Crop geometry refers to the shape of the space available for individual plants. It influences crop yield

through its influence on light interception, rooting pattern and moisture extraction pattern. Crop geometry is altered by changing inter and intra-row spacing (*Planting pattern*).

- Wider spaced crops have advantage under this geometry
 - Plants which requires no restriction in all directions are given square geometry
 - Usually perennial vegetations like trees/shrubs are under this arrangements
- (i) **Square planting** - Square arrangements of plants will be more efficient in the utilization of light, water and nutrients available to the individual plants than in a rectangular arrangement.
- (ii) **Rectangular planting** - Sowing the crop with seed drill, wider inter-row and closer intra-row and closer intra-row spacing leads to rectangularity. Rectangular arrangement facilitates easy intercultivation. Rectangular planting mainly suits annual crops, crops with closer spacing etc., the wider section (row) is given for irrigation, intercultural operation etc.
- It is an arrangement to restrict the endless growth habit in order to switch over from vegetation to the productive phase.
 - This method accommodate high density planting
 - It can facilitate intercropping also.
- (iii) **Triangular planting** - It is a method to accommodate plant density under perennial/tree crops.
- (iv) **Miscellaneous planting** - In rice and ragi transplanting is done either in rows or at random. Skipping of every alternate row is known as skip row planting. When one row is skipped the density is adjusted by decreasing inter-row spacing. When the inter row spacing is reduced between two rows and spacing between two such pair are increased then it is known as paired-row planting. It is generally done to introduce an inter crop.

9.4 AFTER CULTIVATION

It refers to the cultural operations like thinning, gap filling, harrowing, tilling and other operations carried out in a field after the crop has emerged. Thinning and gap filling are done to keep optimum density.

- (i) **Thinning** is done to reduce higher density due to over seed rate or more seeds/hole and uneven broadcasting. Gap filling is done to fill the gaps that exist due to (i) poor quality seed, (ii) soil crusting, (iii) very shallow or very deep placement of seeds, and (iv) poor moisture availability in dry land. Gap filling is done to maintain density by replacing with seedlings reserved for this purpose or resowing with seeds.
- (ii) **Gap filling** is done reasonably early so that plants come to maturity along with other plants. Time may vary with duration of crops. For example, in sugarcane it may be done even 30 days after planting. But in short duration crops like maize, sorghum, rice etc., it should be done within about 10-15 days.

Weeds are plants “**out of place**” in cultivated fields, lawns and other places *i.e.*, a plant growing where it is “**not desired**” or Weeds are unwanted and **undesirable** plant that interfere with utilization of land and water resources and thus adversely affect crop production and human welfare. Sometimes Agriculture also defined as a battle with weeds as they strongly compete with crop plants for growth factors.

10.1 ORIGIN

Weeds are no strangers to man. They have been there ever since he started to cultivate crops about 10,000 B.C. and undoubtedly recognized as a problem from the beginning. To him, any plant in the field other than his crop became weed. Again the characters of certain weed species are very similar to that of wild plants in the region. Some of the crops for example including the wheat of today are the derivatives of wild grass. Man has further improved them to suit his own taste and fancy. Even today they are crossed with wild varieties to transfer the desirable characters such as drought and disease resistance. So the weeds are to begin with essential components of native and naturalized flora but in course of time these plants are well placed in new environment by the conscious and unconscious efforts of man. Hence, it is considered that many weeds principally originated from two important and major arbitrarily defined groups.

- By man’s conscious effort
- By invasion of plants into man created habitats

In the world, 30,000 species of weeds have been listed. Out of which nearly 18,000 species cause serious damage to agricultural production. Eighteen weeds are considered as the most serious in the world and about twenty six species have been listed as principal weeds in crop fields of India, and are listed in *annexure V*. Weeds compete with crops for water, soil nutrients, light and space (*i.e.*, CO₂) and thus reduce crop yields.

10.2 CHARACTERISTICS

Weeds are highly competitive and are highly adaptable under varied adverse situations. Reproductive mechanism is far superior to crop plants particularly under unfavourable side; therefore, weeds are constantly invading the field and try to succeed over less adapted crop plants. Produces larger number of seeds compared to crops. Most of the weed seeds are small in size and contribute enormously to the seed reserves. Weed seeds germinate earlier and their seedlings grow faster. They flower earlier and

mature ahead of the crop they infest. They have the capacity to germinate under varied conditions, but very characteristically, season bound. The peak period of germination always takes place in certain seasons in regular succession year after year. Weed seeds possess the phenomenon of dormancy, which is an intrinsic physiological power of the seed to resist germination even under favourable conditions. Weed seeds do not lose their viability for years even under adverse conditions. Most of the weeds possess C_4 type of photosynthesis, which is an added advantage during moisture stress. They possess extensive root system, which go deeper as well as of creeping type.

A. Factors Favouring Weed Growth

In modern agriculture, the crops grown are widely spaced, increasingly manured and irrigated, very slow growth of crops in initial stages (cotton, sorghum, castor, etc.) and are usually grown in pure stand. Thus, these factors favour for the easy and quick establishment of weeds in crop fields.

B. Harmful Effects

- Weeds compete with crop for space, light, moisture and soil nutrients thus causing reducing in yield.
- Affect quality of farm produce, livestock products such as milk and skin.
- Act as alternate host for many pest and diseases.
- Cause health problems to human beings. *e.g.*, *Parthenium hysterophorus* (congress weed).
- Increase the cost of cultivation due to weeding operation.
- Aquatic weeds transpire large quantity of water, obstruct flow of water; thus affecting fishing, swimming and recreation.
- Reduce the land value (white horse nettle–*Solanum elagenifolium* and *Parthenium hysterophorus*).
- Some weeds are poisonous to livestock–*Lochnera pusilla* and *Abrus precatorius*.
- Weeds (Thorny) reduce the efficiency of human beings and affect movement of farm animals and workers.

C. Losses

1. **Reduction in crop yield** - Weeds compete with crop plants for nutrients, soil moisture, space and sunlight and in general an increase in one kilogram weed growth corresponds to reduction in one kilogram of crop growth. Hence, the crop is smothered and has a final say on crop yield. Depending on type of weed, intensity of infestation, period of infestation, the ability of crop to compete and climatic conditions the loss varies. The percentage range of yield loss due to weeds in some important field crops is given in Table 10.1.

Table 10.1. Yield Losses due to Weeds in some Important Crops

<i>Crop</i>	<i>Yield loss range (%)</i>	<i>Crop</i>	<i>Yield loss range (%)</i>
Rice	9.1 – 51.4	Sugarcane	14.1 – 71.7
Wheat	6.3 – 34.8	Linseed	30.9 – 39.1
Maize	29.5 – 74.0	Cotton	20.7 – 61.0
Milletts	6.2 – 81.9	Carrot	70.2 – 78.0
Groundnut	29.7 – 32.9	Peas	25.3 – 35.5

Among the pests weeds account for 45% reduction in yield while the insects 30%, diseases 20% and other pests 5%.

2. **Loss in crop quality** - If a crop contains weed seeds it is to be rejected, especially when the crop is grown for seed. For example, the wild oat weed seeds are similar in size and shape of the crops like barley, wheat, and its admixture may lead to rejection for seed purpose. Contamination by poisonous weed seeds is unacceptable and increases costs of crop cleaning. The leafy vegetables much suffer due to weed problem as the leafy weed mixture spoil the economic value.
3. **Weeds as reservoirs of pests and diseases** - Weeds form a part of community of organisms in a given area. Consequently, they are food sources for some animals, and are themselves susceptible to many pests and diseases. However, because of their close association with crop they may serve as important reservoirs or alternate host of pests and diseases.
4. **Interference in crop handling** - Some weeds can make the operation of agricultural machinery more difficult, more costly and even impossible. Heavy infestation of *Cynodon dactylon* causes poor ploughing performance.
5. **Reduction in land value** - Heavy infestation by perennial weeds could make the land unsuitable or less suitable for cultivation resulting in loss in its monetary value. Thousands of hectare of cultivable area in rice growing regions of India have been abandoned or not being regularly cultivated due to severe infestation of nut grass (*Cyperus rotundus*) and other perennial grasses.
6. **Limitation of crop choice** - When certain weeds are heavily infested, it will limit the growth of a particular crop. The high infestation of parasitic weeds such as *Striga lutea* may limit the cultivation of sorghum or sugarcane.
7. **Loss of human efficiency** - Weeds reduce human efficiency through physical discomfort caused by allergies and poisoning. Weeds such as congress weed (*Parthenium hysterophorus*) cause itching. Thorny weeds like *Solanum* sp. restrict movement of farm workers in carrying out farm practices such as fertilizer application, insect and disease control measures, irrigation, harvesting, etc.
8. **Problems due to aquatic weeds** - Aquatic weeds that grow along the irrigation canals, channels and water streams restrict the flow of water. Weed obstruction causes reduction in velocity of flow and increases stagnation of water and may lead to high siltation and reduced carrying capacity. Aquatic weeds form breeding grounds for obnoxious insects like mosquitoes. They reduce recreational value by interfering with fishing, swimming, boating, hunting and navigation on streams and canals.
9. **Other problems** - Weeds are troublesome not only in crop plants but also in play grounds and road sides etc. *Alternanthera echinata* and *Tribulus terrestris* occur in many of the playgrounds causing annoyance to players and spectators.

D. Beneficial Effects

Weeds are indirectly responsible for crop cultivation, but for them cultivated crops may not receive much attention

Weeds as fodder - Useful as good fodder for milch animals. Most weeds are preferred by cattle and weeds like *Rynchosia aurea*, *R. capitata* and *Clitoria terneata* are very good fodder legumes and also Hariyali and filed bind weed (*Convolvulus arvensis*).

Weeds as vegetables - Used as green vegetables and weeds serve as human food e.g., *Amaranthus viridis* and *Digera arvensis* used as greens.

Weed as soil binders - *Panicum repense* is an excellent soil binder; keeps bunds in position and prevents soil erosion in high rainfall regions and hilly slopes. Hariyali, kikuyu grass, kollukattai grass (*Cenchrus* sp.) etc., can be used as soil binders.

Weeds as manure - When weeds are ploughed in, they add to the soil plenty of humus. Excellent compost can be made out of many weed plants. *E.g.*, *Calotropis gigantea*, *Croton sparsiflorus* and *Tephrosia purpurea* are used as green leaf manure for rice. In wetlands, weeds are said to form a sort of rotation with paddy and are valuable in preventing loss of nitrates. *Datura sp.* contains 3% N on dry weight basis, Kalingi (*Tephrosia purpurea*) fix N @ 50-75 kg/ha.

Weed as fuel - *Prosopis juliflora* very invasive in nature and notorious tree weed commonly used as fire wood. People make charcoal out of it and are marketed.

Weeds have medicinal values - Many weeds have great therapeutic properties and used as medicine.

• <i>Phyllanthus niruri</i>	–	Jaundice
• <i>Eclipta alba</i>	–	Scorpion sting
• <i>Centella asiatica</i>	–	Improves memory
• <i>Cynodon dactylon</i>	–	Asthma, piles
• <i>Cyperus rotundus</i>	–	Stimulates milk secretion
• <i>Leucas aspera</i>	–	Snake bite
• <i>Calotropis procera</i>	–	Gastric trouble
• <i>Abutilon indicum</i>	–	Piles

Weed as mats and screens - Stems of *Cyperus pangorei* and *Cyperus corymbosus* are used for mat making while *Typha angustata* is used for making screens.

Weed as indicators - Weeds are useful as indicators of good and bad soils. *E. colonum* occurs in rich soils while *Cymbopogon* denotes poor light soil and Sedges are found in ill-drained soils.

Other economic uses

- Useful in manufacturing of agarbattis) *e.g.*, *Cyperus rotundus*
- *Cymbopogon citrates* (Citronella oil) and *C. martinii* (Palmrosa) are used for manufacturing aromatic oil.
- *Argemone mexicana* is used to reclaim alkali soils.
- Ornamental flowers—*Lantana camera* is used for interior decoration.
- Used for fencing purposes. Example—Cactus, *Agave sp.* *Saccharum squarrosus*, etc.

10.3 CLASSIFICATION

Out of 2,50,000 plant species, weeds constitute about 250 species, which are prominent in agricultural and non-agricultural system. Under world conditions about 30,000 species is grouped as weeds. Weeds may be classified in the following ways.

10.3.1 Based on Morphology

Based on the morphology of the plant, the weeds are also classified into three categories. This is the most widely used classification by the weed scientists.

- (a) **Grasses** - All the weeds come under the family Poaceae are called as grasses which are characteristically having long narrow spiny leaves. The examples are *Echinochloa colonum*, *Cynodon dactylon*.

- (b) **Sedges** - The weeds belonging to the family Cyperaceae come under this group. The leaves are mostly from the base having modified stem with or without tubers. The examples are *Cyperus rotundus*, *Fimbristylis miliacea*.
- (c) **Broad leaved weeds** - This is the major group of weeds as all other family weeds come under this except that is discussed earlier. All dicotyledon weeds are broad leaved weeds. The examples are *Flavaria australacica*, *Digera arvensis*, *Abutilon indicum*.

10.3.2 Based on Life Span of Weeds

Based on life span (Ontogeny), weeds are classified as Annual weeds, Biennial weeds and Perennial weeds.

- (a) **Annual Weeds** - Those that live only for a season or year and complete their life cycle in that season or year is called annual. These are small herbs with shallow roots and weak stem. Produces seeds in profusion and the mode of propagation is commonly through seeds. After seeding the annuals die away and the seeds germinate and start the next generation in the next season or year following. Most common field weeds are annuals. The examples are:

- (a) Monsoon annual - *Commelina benghalensis*, *Boerhaavia erecta*
 (b) Winter annual - *Chenopodium album*

- (b) **Biennials** - It completes the vegetative growth in the first season, flower and set seeds in the succeeding season and then dies. These are found mainly in non-cropped areas. *e.g.*, *Alternanthera echinata*, *Daucus carota*
- (c) **Perennials** - Perennials live for more than two years and may live almost indefinitely. They adapted to withstand adverse conditions. They propagate not only through seeds but also by underground stem, root, rhizomes, tubers etc. And hence they are further classified into

Simple perennials: Plants propagated only by seeds. *E.g.*, *Sonchus arvensis*.

Bulbous perennials: Plants, which possess a modified stem with scales and reproduce mainly from bulbs and seeds. *e.g.*, *Allium* sp.

Corm perennials: Plants that possess a modified shoot and fleshy stem and reproduce through corm and seeds. *e.g.*, *Timothy* sp.

Creeping perennials: Reproduced through seeds as well as with one of the following.

Rhizome: Plants having underground stem—*Sorghum halapense*

Stolon: Plants having horizontal creeping stem above the ground—*Cynodon dactylon*

Roots: Plants having enlarged root system with numerous buds—*Convolvulus arvensis*

Tubers: Plants having modified rhizomes adapted for storage of food—*Cyperus rotundus*

10.3.3 Based on Ecological Affinities

- (a) **Wetland weeds** - They are tender annuals with semi-aquatic habit. They can thrive as well under waterlogged and in partially dry condition. Propagation is chiefly by seed. *e.g.*, *Ammania baccifera*, *Eclipta alba*.
- (b) **Garden land weeds** - These weeds neither require large quantities of water like wetland weeds nor can they successfully withstand extreme drought as dry land weeds. *e.g.*, *Trianthema portulacastrum*, *Digera arvensis*.
- (c) **Dry land weeds** - These are usually hardy plants with deep root system. They are adapted to withstand drought on account of mucilaginous nature of the stem and hairiness. *E.g.*, *Tribulus terrestris*, *Convolvulus arvensis*.

10.3.4 Based on Soil Type (Edaphic)

- (a) **Weeds of black cotton soil:** These are often closely allied to those that grow in dry condition. *e.g.*, *Aristolochia bracteata*.
- (b) **Weeds of red soils:** They are like the weeds of garden lands consisting of various classes of plants. *e.g.*, *Commelina benghalensis*.
- (c) **Weeds of light, sandy or loamy soils:** Weeds that occur in soils having good drainage. *e.g.* *Leucas aspera*.
- (d) **Weeds of laterite soils:** *e.g.*, *Lantana camara*, *Spergula arvensis*.

10.3.5 Based on their Botanical Family

Graminae – *Cynodon dactylon*

Solanaceae – *Solanum eleagnifolium*

10.3.6 Based on their Place of Occurrence

- (a) **Weeds of crop lands:** The majorities of weeds infest the cultivated lands and cause hindrance to the farmers for successful crop production. *e.g.*, *Phalaris minor* in wheat.
- (b) **Weeds of pasture lands:** Weeds found in pasture/grazing grounds. *e.g.*, *Indigofera enneaphylla*
- (c) **Weeds of waste places:** Corners of fields, margins of channels etc., where weeds grow in profusion. *e.g.* *Gynandropsis pentaphylla*, *Calotropis gigantea*.
- (d) **Weeds of playgrounds, road-sides:** They are usually hardy, prostrate perennials, capable of withstanding any amount of trampling. *e.g.*, *Alternanthera echinata*, *Tribulus terrestris*.

10.3.7 Based on Cotyledon Number

Based on number of cotyledons it possess it can be classified as dicots and monocots.

- (a) Monocots *e.g.*, *Panicum flavidum*, *Echinochloa colona*.
- (b) Dicots *e.g.*, *Crotalaria verucosa*, *Indigofera viscosa*.

10.3.8 Based on Soil pH

Based on pH of the soil the weeds can be classified into three categories.

- (a) **Acidophile:** Acid soil weeds *e.g.* *Rumex acetosella*.
- (b) **Basophile:** Saline and alkaline soil weeds *e.g.* *Taraxacum stricta*.
- (c) **Neutrophile:** Weeds of neutral soils *e.g.* *Acalypha indica*.

10.3.9 Based on Origin

- (a) **Indigenous weeds:** All the native weeds of the country are coming under this group and most of the weeds are indigenous. *e.g.* *Acalypha indica*, *Abutilon indicum*.
- (b) **Introduced or Exotic weeds:** These are the weeds introduced from other countries. These weeds are normally troublesome and control becomes difficult. *e.g.*, *Parthenium hysterophorus*, *Phalaris minor*, *Acanthospermum hispidum*

10.3.10 Based on their Nature/on Specificity

Besides the various classes of weeds, a few others deserve special attention due to their specificity. They are (a) poisonous weeds, (b) parasitic weeds, and (c) aquatic weeds.

- (a) **Poisonous weeds** - The poisonous weeds cause ailment on livestock resulting in death and cause great loss. These weeds are harvested along with fodder or grass and fed to cattle or while

grazing, the cattle consumes these poisonous plants. *e.g.*, *Datura fastuosa*, *D. stramonium* and *D. metel* are poisonous to animals and human beings. The berries of *Withania somnifera* and seeds of *Abrus precatorius* are poisonous.

- (b) **Parasitic weeds** - The parasite weeds are either total or partial which means, the weeds that depend completely on the host plant are termed as total parasites while the weeds that partially depend on host plant for minerals and capable of preparing its food from the green leaves are called as partial parasites. Those parasites that attack roots are termed as root parasites and those, which attack shoot of other plants, are called as stem parasites. The typical examples of different parasitic weeds are:

1. Total root parasite - *Orabanche cernua* on Tobacco
2. Partial root parasite - *Striga lutea* on sugarcane and sorghum
3. Total stem parasite - *Cuscuta chinensis* on leucerne and onion
4. Partial stem parasite - *Cassytha filiformis* on orange trees and *Loranthus longiflorus* on mango and other trees.

- (c) **Aquatic weeds** - Unwanted plants, which grow in water and complete at least a part of their life cycle in water are called as aquatic weeds. They are further grouped into four categories as submersed, emersed, marginal and floating weeds.

Submersed weeds - These weeds are mostly vascular plants that produce all or most of their vegetative growth beneath the water surface, having true roots, stems and leaves. *e.g.*, *Utricularia stellaris*, *Ceratophyllum demersum*.

Emersed weeds - These plants are rooted in the bottom mud, with aerial stems and leaves at or above the water surface. The leaves are broad in many plants and sometimes like grasses. These leaves do not rise and fall with water level as in the case of floating weeds. *e.g.*, *Nelumbium speciosum*, *Jussieua repens*.

Marginal weeds - Most of these plants are emersed weeds that can grow in moist shoreline areas with a depth of 60 to 90 cm water. These weeds vary in size, shape and habitat. The important genera that come under this group are; *Typha*, *Polygonum*, *Cephalanthus*, *Scirpus*, *etc.*

Floating weeds - These weeds have leaves that float on the water surface either singly or in cluster. Some weeds are free floating and some rooted at the mud bottom and the leaves rise and fall as the water level increases or decreases. *e.g.*, *Eichhornia crassipes*, *Pistia stratiotes*, *Salvinia*, *Nymphaea pubescens*.

10.3.11 Based on Nature of Stem

Based on development of bark tissues on their stems and branches, weeds are classified as woody, semi-woody and herbaceous species.

Woody weeds: Weeds include shrubs and under shrubs and are collectively called brush weeds. *e.g.*, *Lantana camera*, *Prosopis juliflora*.

Semi-woody weeds: *e.g.*, *Croton sparsiflorus*.

Herbaceous weeds: Weeds have green, succulent stems are of most common occurrence around us. *e.g.*, *Amaranthus viridis*.

10.4 WEED DISSEMINATION (DISPERSAL OF WEEDS)

Dispersal of mature seeds and live vegetative parts of weeds is nature's way of providing non-competitive sites to new individuals. Had there been no way of natural dispersal of weeds, we would not have had them today in such widely spread and vigorous forms. In the absence of proper means of their dispersal, weeds could not have moved from one country to another. "Weeds are good travelers". An effective dispersal of weed seeds and fruits requires two essentials viz., a successful dispersing agent and an effective adaptation to the new environment. Common weed dispersal agents are: (a) wind, (b) water, (c) animals and (d) human.

- (a) **Wind** - Weed seeds and fruits that disseminate through wind possess special organs to keep them afloat. Such organs are:

Pappus - It is a parachute like modification of persistent calyx into hairs. e.g., Asteraceae family weeds. e.g., *Tridax procumbens*.

Comose - Some weed seeds are covered with hairs, partially or fully e.g., *Calotropis* sp.

Feathery, persistent styles - Styles are persistent and feathery. e.g., *Anemone* sp.

Baloon - Modified papery calyx that encloses the fruits loosely along with entrapped air. e.g., *Physalis minima*.

Wings - One or more appendages that act as wings. e.g., *Acer macrophyllum*.

- (b) **Water** - Aquatic weeds disperse largely through water. They may drift either as whole plants, plant fragments or as seeds with the water currents. Terrestrial weed seeds also disperse through irrigation and drainage water.
- (c) **Animals** - Birds and animals eat many weed fruits. The ingested weed seeds are passed in viable form with animal excreta (0.2% in chicks, 9.6% in calves, 8.7% in horses and 6.4% in sheep), which is dropped wherever the animal moves. This mechanism of weed dispersal is called endozoochory e.g., *Lantana* seeds by birds. *Loranthus* seeds stick on beaks of birds. Farm animals carry weed seeds and fruits on their skin, hair and hooves. This is aided by special appendages such as Hooks (*Xanthium strumarium*), Stiff hairs (*Cenchrus* sp.), Sharp spines (*Tribulus terrestris*) and Scarious bracts (*Achyranthus aspera*). Even ants carry a huge number of weed seeds. Donkeys eat *Prosopis julifera* pods.
- (d) **Man** - Man disperses numerous weed seeds and fruits with raw agricultural produce. Weeds mature at the same time and height along with crop, due to their similar size and shape as that of crop seed man unknowingly harvest the weeds also, and aids in dispersal of weed seeds. Such weeds are called "Satellite weeds" e.g. *Avena fatua*, *Phalaris minor*.
- (e) **Manure and silage** - Viable weed seeds are present in the dung of farm animals, which forms part of the FYM. Besides, addition of mature weeds to compost pit as farm waste also act as source.
- (f) **Dispersal by machinery** - Machinery used for cultivation purposes like tractors can easily carries weed seeds, rhizomes and stolons when worked on infested fields and latter dropping them in other fields to start new infestation.
- (g) **Intercontinental movement of weeds** - Introduction of weeds from one continent to another through 1. Crop seed, 2. Feed stock, 3. Packing material and 4. Nursery stock. e.g., *Parthenium hysterophorus*.

10.5 WEED ECOLOGY

Knowing weed biology such as seed production capacity, germination dormancy and their ecological

adaptations will help in formulating suitable weed control measures. Ecology is the interrelationship between organisms and their environment. We concerned with growth characteristics and adaptations that enable weeds to survive the change in the environment. Man plays an important role in changing the environment by altering the crop husbandry practices and by maintaining weed free monocrop or multicrop culture.

A. Survival Mechanism

The seed is the primary means of survival mechanism of annual weeds while the vegetative parts such as buds, rhizomes tubers and bulbs offer on additional mechanism for perennial weeds.

- (a) **Sexual reproduction** - Through sexual reproduction abundant and small seeds are produced. Annual and biennial weeds depend on seed production, as the sole means of propagation and survival of perennial weeds are less dependent on this mechanism. The seed production capacity of some of the weeds is given Table 10.2.

Table 10.2. Seed Production Capacity of Weeds

<i>Ontogeny</i>	<i>Seeds/plant</i>	<i>Name of weed/crop</i>	<i>Seeds/plant</i>
Perennials	16,629	<i>Amaranthus retroflexus</i>	1,96,405
Biennials	26,600	<i>Solanum nigrum</i>	1,78,000
Annuals	20,832	<i>Chenopodium album</i>	72,000
		<i>Trianthema portulacastrum</i>	52,000
		Wheat & Rice	90 to 100

A few weeds may produce seed through apomixis *i.e.*, without fertilization. *e.g.*, Ferns reproduce by spores.

- (b) **Vegetative reproduction** - Vegetative structures normally rely upon parent for their plant nutrient conferring their competitive advantage but has disadvantage also owing to their genetically identical nature and as such may not well adapted to change in environment. The vegetative structures include stolons, rhizomes, tubers, bulb, corms and roots.

B. Seed Dormancy as Survival Mechanism

Weed seeds possess a variety of special germination mechanisms adapted to changes in temperature, moisture, aeration, exposure to light, depth of burial of seeds etc. When conditions are unfavourable for germination, they can remain dormant or delay germination. Conditions favourable for weeds seed germination are:

- Seeds of many weeds require an exposure to light for germination. This is regulated by bluish-green protein pigment called phytochrome.
- Many weed seeds germinate under aerobic conditions while some require anaerobic condition. Soil turnover during ploughing and other operations exposes the seeds to light and induces germination.
- Periodicity of germination is another specialized germination mechanism. *Amaranthus* sp. have a definite pattern of peaks of germination at regular intervals.
- Summer annuals favour higher temperature and winter annuals germinate at lower temperatures some weeds germinate freely throughout the year.

C. Seed Dormancy

Dormancy is a state of seeds and buds in which they are alive but not germinated. If all weed seeds were to germinate at one time, their seedlings could be destroyed. Dormancy allows storage of millions of weed seeds in soil and enables them to grow in flushes over years. In this context, the old gardeners saying “*One year Seeding seven years Weeding*” is very appropriate. In fact, weed seeds have been found viable even after 20-80 years of burial in soil.

Weed seeds exhibit three types of dormancy.

1. **Enforced dormancy** - It is due to deep placement of weed seeds in soil during ploughing of the field. Weed seeds germinate readily when they are restored to top 3-5 cm. Enforced Dormancy is a non-specific character of seed. Cultivation encounters enforced dormancy by bringing the weeds to surface where they are exposed to light besides better aeration. High soil temperature and NO₃ content of surface soil may further help in breaking seed dormancy.
2. **Innate dormancy** - It is a genetically controlled character and it is a feature of specific weed seeds, which fail to germinate even if they are present in the top 3-5 cm soil, and adequate soil moisture and temperature provided to them. The possible reasons are the presence of (i) hard seed coats *e.g., Setaria, Ipomoea, Xanthium* spp. and (ii) immature embryos *e.g., Polygonum*. In certain weed seeds particularly of Xerophytic origin, presence of inhibitors is responsible for innate dormancy. It can be overcome with passage of time, or under the influence of some climatic pressure.
3. **Induced dormancy** - Induced dormancy results from some sudden physiological change in normally non-dormant weed seeds under the impact of marked rise in temperature and or CO₂ content of soil, low O₂ pressure, water logging etc. *Wild oat (Avena fatua) seeds exhibit all three kinds of dormancy.*

D. Persistence of Weeds (adaptation)

Persistence is an adaptive potential of a weed that enables it to grow in any environment. In an agricultural situation, the cropping system with its (associated habitat) management practices, determines the persistence of weed species. It is largely influenced by climatic, edaphic (soil) and biotic factors, which affect its occurrence, abundance, range and distribution.

Factors affecting persistence

1. **Climatic factors** - Climate can effect variations in cuticle development, pubescence, vegetative growth, vigour, competitiveness *etc.* Climate thus has a profound effect on the persistence of weeds, which can adapt to a wide variety of climates. The important climatic factors are light, temperature, rainfall, wind and humidity.

Light - Light intensity, quality and duration are important in influencing the germination, growth, reproduction and distribution of weeds. Photoperiod governs flowering time, seed setting and maturation and on the evolution of various ecotypes within a weed species. Tolerance to shading is a major adaptation that enables weeds to persist.

Temperature - Temperature of atmosphere and soil affects the latitudinal and longitudinal distribution of weeds. Soil temperature affects seed germination and dormancy, which is a major survival mechanism of weeds.

Rainfall - Rainfall has a significant effect on weed persistence and distribution. More rainfall or less rainfall determines reproduction and survival.

Wind - Wind is a principal factor in the dissemination of weeds.

2. **Soil factors** - Soil factors are soil water, aeration, temperature, pH and fertility level and cropping system. Some weed species are characteristically alkali plants, known as basophilic (pH 8.5) which can grow well in alkali soils and those grow in acidic soil is known as Acidophiles.

Basophiles

Alkaligrass – *Puccinallia* spp.

Quack grass – *Agropyron repens*

Acidophiles

Cynodon dactylon

Neutophiles

Common weed

Digitaria sanguinalis

Several weed species of compositae family grow well in saline soils. A shift in soil pH, towards acid side due to continuous use of Ammonium sulphate as a 'N' source could cause a shift in the weed spectrum. Many weeds can grow well in soils of low fertility level however, can adapt well to soils of high fertility also. Weeds also has adaptation to moist soil, drought condition etc.

3. **Biotic factors** - In a cropping situation, the major effects on weeds are those exerted by the crop as it competes for available resources. Once, a particular weed species is introduced, its persistence is determined by the degree of competition offered by the crop and also the agricultural practices associated with the growing of a crop may encourage or discourage specific weeds.

E.g., Ponding of water – *Cynodon* dies
Repeated cultivation – discourage nut sedge.

Crops that serve as hosts to parasitic weeds, (Sorghum – Striga) crop-induced stimulants are examples of other biotic factors.

10.6 CROP-WEED INTERACTIONS

Competition and allelopathy are the main interactions, which are of importance between crop and weed. Allelopathy is distinguished from competition because it depends on a chemical compound being added to the environment while competition involves removal or reduction of an essential factor or factors from the environment, which would have been otherwise utilized.

I. Crop Weed Competition

Weeds appear much more adapted to agro-ecosystems than our crop plants. Without interference by man, weeds would easily wipe out the crop plants. This is because of their competition for nutrients, moisture, light and space, which are the principle factors of production of crop. Generally, an increase in on kilogram of weed growth will decrease one kilogram of crop growth.

1. **Competition for nutrients** - Weeds usually absorb mineral nutrients faster than many crop plants and accumulate them in their tissues in relatively larger amounts.
 - *Amaranthus* sp. accumulate over 3% N on dry weight basis and are termed as “nitrophills”.
 - *Achyranthus aspera*, a ‘P’ accumulator with over 1.5% P₂O₅.
 - *Chenopodium* sp. and *Portulaca* sp. are ‘K’ lovers with over 1.3% K₂O in dry matter.

Table 10.3. Mineral Composition (%) of certain common Weeds on Dry Matter Basis

Sl. No.	Species	N	P ₂ O ₅	K ₂ O
1.	<i>Achyranthus aspera</i>	2.21	1.63	1.32
2.	<i>Amaranthus viridis</i>	3.16	0.06	4.51
3.	<i>Chenopodium album</i>	2.59	0.37	4.34
4.	<i>Cynodon dactylan</i>	1.72	0.25	1.75
5.	<i>Cyperus rotundus</i>	2.17	0.26	2.73
	<i>Crop plants</i>			
1.	Rice	1.13	0.34	1.10
2.	Sugarcane	0.33	0.19	0.67
3.	Wheat	1.33	0.59	1.44

The associated weed is responsive to nitrogen and it utilizes more of the applied 'N' than the crop. e.g., the 'N' uptake by *Echinochloa crusgalli* is more than rice. Nutrient removal by weeds leads to huge loss of nutrients in each crop season, which is often twice that of crop plants. For instance at early stages of maize cultivation, the weeds found to remove 9 times more of N, 10 times more of P and 7 times more of K.

- Competition for moisture** - In general, for producing equal amounts of dry matter, weeds transpire more water than do most of our crop plants. It becomes increasingly critical with increasing soil moisture stress, as found in arid and semi-arid areas. As a rule, C₄ plants utilize water more efficiently resulting in more biomass per unit of water. *Cynodon dactylon* had almost twice as high transpiration rate as pearl millet. In weedy fields soil moisture may be exhausted by the time the crop reaches the fruiting stage, i.e., the peak consumptive use period of the crop, causing significant loss in crop yields.
- Competition for light** - It may commence very early in the crop season if a dense weed growth smothers the crop seedlings. It becomes important element of crop-weed competition when moisture and nutrients are plentiful. In dry land agriculture in years of normal rainfall the crop-weed competition is limited to nitrogen and light. Unlike competition for nutrients and moisture once weeds shade a crop plant, increased light intensity cannot benefit it.
- Competition for space (CO₂)** - Crop-weed competition for space is the requirement for CO₂ and the competition may occur under extremely crowded plant community condition. A more efficient utilization of CO₂ by C₄ type weeds may contribute to their rapid growth over C₃ type of crops.

A. Weed Competition on Crop Growth and Yield

Crop growth and yield is affected. Crop suffers from nutritional deficiency. Leaf area development is reduced. Yield attributes will be lowered. It reduces the water use by the crop and affects the dry matter production. It lowers the input response and causes yield reduction. Pest and disease incidence on crops will be more due to weeds.

B. Factors affecting the Competitive Ability of Crops Against Weeds

- Density of weeds** - Increase in density of weed decrease in yield is a normal phenomena. However, it is not linear as few weeds do not affect the yields so much as other weed does and hence, it is a sigmoidal relationship.

- (b) **Crop density** - Increase in plant population decreases weed growth and reduces competition until they are self-competitive. Crop density and rectangularity are very important in determining the quantum and quality of crop environment available for the growth of weeds. Wide row spacing with simultaneous high, intra-row crop plant population may induce dense weed growth. In this respect, square planting of crops in which there are equal row and plant spacing should be ideal in reducing intra-crop plant competition.
- (c) **Type of weeds species** - The type of weeds that occur in a particular crop influences the competition. Occurrence of a particular species of weed greatly influences the competition between the crop and weed. For *e.g.*, *E. crusgalli* in rice, *Setaria viridis* in corn and *Xanthium* sp. in soybean affects the crop yield. *Flavaria australasica* offers more competition than the grasses.
- (d) **Type of crop species and their varieties** - Crops and their varieties differ in their competing ability with weeds *e.g.*, the decreasing order of weed competing ability is as: barley, rye, wheat and oat. High tolerance of barley to competition from weeds is assigned to its ability to develop more roots that are extensive during initial three weeks growth period than the others. Fast canopy forming and tall crops suffer less from weed competition than the slow growing and short stature and crops. Dwarf and semi-dwarf varieties of crops are usually more susceptible to competition from weeds than the tall varieties because they grow slowly and initial stage. In addition, their short stature covers the weeds less effectively. When we compare the crop-weed competition between two varieties of groundnut TMV 2 (Bunch) and TMV 3 (Spreading). TMV 2 incurred a loss of over 30% pod yield under uncontrolled weed-crop competition while TMV 3 lost only about 15% in its yield. The main reason is due to the spreading nature of TMV 3, which smothered weeds. Longer duration cultivars of rice have been found more competitive to weeds than the short duration ones.
- (e) **Soil factor** - Soil type, soil fertility, soil moisture and soil reaction influences the crop weed competition. Elevated soil fertility usually stimulates weeds more than the crop, reducing thus crop yields. Fertilizer application of weedy crop could increase crop yields to a much lower level than the yield increase obtained when a weed free crop is applied with fertilizer. Weeds are adapted to grow well and compete with crops, in both moisture stress and ample moisture conditions. Removal of an intense moisture stress may thus benefit crops more than the weeds leading to increased yields. If the weeds were already present at the time of irrigation, they would grow so luxuriantly as to completely overpower the crops. If the crop is irrigated after it has grown 15 cm or more in a weed free environment irrigation could hasten closing in of crop rows, thus suppressing weeds. Abnormal soil reactions often aggravate weed competition. It is therefore specific weed species suited to different soil reactions exist with us, our crops grow best only in a specified range of soil pH. Weeds would offer more intense competition to crops on normal pH soils than on normal pH soils.
- (f) **Climate** - Adverse weather condition, *e.g.*, drought, excessive rains, extremes of temperature, will favour weeds since most of our crop plants are susceptible to climatic stresses. It is further intensified when crop cultivation is stratified over marginal lands. All such stresses weaken crops inherent capacity to fight weeds.
- (g) **Time of germination** - In general, when the time of germination of crop coincides with the emergence of first flush of weeds, it leads to intense Crop-Weed interference. Sugarcane takes about one month to complete its germination phase while weeds require very less time to complete its germination. Weed seeds germinate most readily from 1.25 cm of soil. Few weeds even from 15 cm depth. Therefore, planting method that dries the top 3 to 5 cm of soil rapidly

enough to deny weed seeds opportunity to absorb moisture for their germination usually postpones weed emergence until the first irrigation. By this time the crop plants are well established to compete with late germinating weeds.

- (h) **Cropping practices** - Cropping practices, such as method of planting crops, crop density and geometry and crop species and varieties have pronounced effects on Crop-Weed interference.
- (i) **Crop maturity** - Maturity of the crop is yet another factor which affects competition between weeds and crop. As the age of the crop increases the competition for weeds decreases due to its good establishment. Timely weeding in the early growth stages of the crop enhances the yield significantly.

C. Critical period of Weed Competition

Critical period of weed competition is defined as the shortest time span during the crop growth when weeding results in highest Economic returns. The critical period of crop-weed competition is the period from the time of sowing up to, which the crop is to be maintained in a weed free environment to get the highest economical yield. The weed competition in crop field is invariably severe in early stages of crop than at later stages. Generally in a crop of 100 days duration, the first 35 days after sowing should be maintained in a weed free condition (Table 10.4). There is no need to attempt for a weed free condition throughout the life period of the crop, as it will entail unnecessary additional expenditure without proportionate increase in yield.

Table 10.4. Critical period of Weed Competition for important Crops

<i>Sl.No.</i>	<i>Crops</i>	<i>Days from sowing</i>
1.	Rice (lowland)	35
2.	Rice (upland)	60
3.	Sorghum	30
4.	Finger millet	15
5.	Pearl millet	35
6.	Maize	30
7.	Cotton	35
8.	Sugarcane	90
9.	Groundnut	45
10.	Soybean	45
11.	Onion	60
12.	Tomato	30

It becomes clear that weed free condition for 2-8 weeks in general are required for different crops and emphasizes the need for timely weed control without which the crop yield gets drastically reduced.

II. Allelopathy

Allelopathy is the detrimental effects of chemicals or exudates produced by one (living) plant species on the germination, growth or development of another plant species (or even microorganisms) sharing the same habitat. Allelopathy does not form any aspect of crop-weed competition, rather, it causes Crop-Weed interference, it includes competition as well as possible allelopathy. Allelo-chemicals are produced by plants as end products, by-products and metabolites liberalized from the plants; they

belong to phenolic acids, flavanoides, and other aromatic compounds viz., terpenoids, steroids, alkaloids and organic cyanides. These allelochemical's action is in interfering with cell elongation, photosynthesis, respiration, mineral ion uptake and protein and nucleic acid metabolism. Allelopathy technique can be applied in biological control of weeds by using cover crop for biological control and using allelopathic chemicals as bio-herbicides.

Factors influencing allelopathy

(a) Plant factors

- **Plant density:** Higher the crop density the lesser will be reaction due to allelochemicals it.
- **Life cycle:** If weed emerges later there will be less problem of allelochemicals.
- **Plant age:** The release of allelochemicals occurs only at critical stage. For *e.g.*, in case of *Parthenium*, allelopathy occurs during its rosette and flowering stage.
- **Plant habit:** The allelopathic interference is higher in perennial weeds.
- **Plant habitat:** Cultivated soil has higher values of allelopathy than uncultivated soil.
- **Climatic factors:** The soil and air temperature as well as soil moisture influence the allelochemicals potential.
- **Soil factors-** Physico-chemical and biological properties influence the presence of allelochemicals.
- **Stress factors-** Abiotic and biotic stresses may also influence the activity of allelochemicals.

(i) Effect of weeds on crops

Maize - Leaves and inflorescence of *Parthenium* sp. affect the germination and seedling growth and tubers of *Cyperus esculentus* affect the dry matter production.

Sorghum - Stem of *Solanum* affects germination and seedling growth and leaves and inflorescence of *Parthenium* affect germination and seedling growth.

Wheat - Seeds of wild oat affect germination and early seedling growth; leaves of *Parthenium* affects general growth; tubers of *C. rotundus* affect dry matter production and green and dried leaves of *Argemone mexicana* affect germination and seedling growth.

Sunflower - Seeds of *Datura* sp. affect germination and growth.

(ii) Effect of crop plants on weeds

- Root exudation of maize inhibits the growth of *Chenopodium album*.
- The cold water extracts of wheat straw when applied to weeds reduce germination and growth of *Abutilon* sp.

(iii) Effect of weeds on weeds

- Extract of leaf leachate of decaying leaves of *Polygonum* contains flavonoides which are toxic to germination, root and hypocotyls growth of weeds like *Amaranthus spinosus*.
- Inhibitor secreted by decaying rhizomes of *Sorghum halepense* affect the growth of *Digitaria sanguinalis* and *Amaranthus* sp.

10.7 WEED CONTROL

For designing any weed control programme in a given area, one must know the nature and habitat of the weeds in that area, how they react to environmental changes and how they respond to herbicides. Before selecting a method of weed control one, must have information on the number of viable seeds nature of dispersal of seeds, dormancy of seeds, longevity of buried seeds and ability to survive under

adverse conditions, life span of the weed, soil textures moisture and (In case of soil applied volatile herbicides the herbicide will be successful only in sandy loam soil but not in clayey soil. Flooding as a method of weed control will be successful only in heavy soil and not in sandy soil) the area to be controlled. Weed management involves both preventive and control as well as eradication measures (curative) to combat weed problem. It has a broader concept than mere weed control.

The prime objective of a weed management system is to maintain an environment that is as detrimental to weeds as possible by employing both preventive and curative measures through the use of mechanical, biological, cultural and chemical methods either alone or in combination. The principles of weed control are:

- Prevention
- Eradication
- Control
- Management

A. Preventive Method

The appearance of weeds in the cropped areas can be prevented by adopting the following measures for adoption wherever possible and practicable. It encompasses all measures taken to prevent the introduction and/or establishment and spread of weeds. Such areas may be local, regional or national in size. No weed control programme is successful if adequate preventive measures are not taken to reduce weed infestation. It is a long term planning so that the weeds could be controlled or managed more effectively and economically than is possible where these are allowed to disperse freely.

- Avoid using crop that are infested with weed seeds *i.e.*, use of clean seeds for sowing. Weed free crop seeds may be produced by following the pre-cautionary measures.
 - Separating crop seeds from admixture of crop and weed seeds using physical differences like size, shape, colour, weight/texture and electrical properties.
 - Using air-screen cleaners and specific gravity separators, which differentiate seeds based on seed size, shape, surface area and specific gravity.
 - Through means of seed certification we can get certified seeds and can be used safely because the certified seeds contain no contaminant weed seeds.
 - Weed laws are helpful in reducing the spread of weed species and in the use of well adapted high quality seeds. They help in protecting the farmers from using mislabeled or contaminated seed and legally prohibiting seeds of noxious weeds from entering the country.
 - Quarantine laws enforce isolation of an area in which a severe weed has become established and prevent the movement of the weed into an uninfected area.
 - Use of pre-emergence herbicides also helpful in prevention because herbicides will not allow the germination of weeds.
- Avoid feeding screenings and other material containing weed seeds to the farm animals.
- Avoid adding weeds to the manure pits.
- Avoid the use of raw dung as manure.
- Pull out seedlings in nurseries carefully without weed seedlings.
- Clean the farm machinery thoroughly before moving it from one field to another. This is particularly important for seed drills.
- Avoid the use of gravel sand and soil from weed-infested.

- Inspect nursery stock for the presence of weed seedlings, tubers, rhizomes, etc.
- Keep irrigation channels, fence-lines, bunds un-cropped areas and roads clean.
- Use vigilance. Inspect your farm frequently for any strange looking weed seedlings. Destroy such patches of a new weed by digging deep and burning the weed along with its roots. Sterilize the spot with suitable chemical.
- Quarantine regulations are available in almost all countries to deny the entry of weed seeds and other propagules into a country through airports and shipyards.

B. Curative Methods

These methods include eradication and control of weeds in the field.

1. **Eradication Measures** - It is an ideal weed control method rarely achieved. It infers that a given weed species, its seed and vegetative part has been killed or completely removed from a given area and that weed will not reappear unless reintroduced to the area. Because of its difficulty and high cost, eradication is usually attempted only in smaller areas such as few ha., a few thousand m² or less. Eradication is often used in high value areas such as green houses, ornamental plant beds and containers. This may be desirable and economical when the weed species is extremely noxious and persistent as to make cropping difficult and economical. Weeds are destroyed immediately before its multiplication, dispersion and acclimatization as and when a new weed species is found. It can be done by,

- destroying the species at the initial stage of introduction and before it produces any propagule (at an early growth stage), and
- degenerating the buried dormant viable seeds by fumigation, flooding, heating and other methods.

2. **Control Measures** - In these method weeds are not eradicated but their growth is checked and the number of weeds (weed intensity) is minimized so that they do not affect crop yield or it encompasses those processes where by weed infestations are reduced but not necessarily eliminated. It is a matter of degree ranging from poor to excellent. In control methods, the weeds are seldom killed but their growth is severely restricted, the crop makes a normal yield. In general, the degree of weed control obtained is dependent on the characters of weeds involved and the effectiveness of the control method used.

Methods of weed control - Weed control aims at only putting down the weeds present by some kind of physical or chemical means while weed management is a system approach whereby whole land use planning is done in advance to minimize the very invasion of weeds in aggressive forms and give crop plants a strongly competitive advantage over the weeds. Weed control methods are grouped into cultural, physical, chemical and biological. Every method of weed control has its own advantages and disadvantages. No single method is successful under all weed situations. Many a time, a combination of these methods gives effective and economic control than a single method.

(a) **Mechanical methods** - This method aims to destroy weeds by cutting and removing or by desiccation and exhaustion of weeds by adopting several methods like hand hoeing, hand pulling, tillage, flooding, burning, mulching by non-living materials etc. However the choice of a method depends on location, extent and habitat of weeds.

1. **Tillage** - Tillage removes weeds from the soil resulting in their death. It may weaken plants through injury of root and stem pruning, reducing their competitiveness or regenerative capacity. Tillage also buries weeds. Tillage operation includes ploughing, disking, harrowing and leveling which is used to promote the germination of weeds through soil turnover and exposure of seeds to sunlight, which can be destroyed effectively later. In case of perennials, both top and underground growth is injured and destroyed by tillage.
2. **Hoeing** - Hoe has been the most appropriate and widely used weeding tool for centuries. It is however, still a very useful implement to obtain results effectively and cheaply. It supplements the cultivator in row crops. Hoeing is particularly more effective on annuals and biennials as weed growth can be completely destroyed. In case of perennials, it destroyed the top growth with little effect on underground plant parts resulting in re-growth.
3. **Hand pulling/ hand weeding** - It is done by physical removal or pulling out of weeds by hand or removal by implements called khurpi, which resembles sickle. It is probably the oldest method of controlling weeds and it is still a practical and efficient method of eliminating weeds in cropped and non-cropped lands. It is very effective against annuals, biennials and controls only upper portions of perennials. Hand pulling/hoeing is effective only when the weed infested area is small. Repeated hoeing and tillage is essential to control nut grass.
4. **Digging** - Digging is very useful in the case of perennial weeds to remove the underground propagating parts of weeds from the deeper layer of the soil.
5. **Chiseling**- It is done by hand using a chisel hoe, similar to a spade with a long handle. It cuts and shapes the above ground weed growth.
6. **Sickling and mowing** - Sickling is also done by hand with the help of sickle to remove the top growth of weeds to prevent seed production and to starve the underground parts. It is popular in sloppy areas where only the tall weed growth is sickled leaving the root system to hold the soil in place to prevent soil erosion. **Mowing** is a machine-operated practice mostly done on roadsides and in lawns.
7. **Burning** - Burning or fire is often an economical and practical means of controlling weeds. Burning the weeds will control the weed problem in sugarcane widely spaced field crops and orchards. It is used to (a) dispose of vegetation, (b) destroy dry tops of weeds that have matured, (c) kill green weed growth in situations where cultivations and other common methods are impracticable.
8. **Flooding** - Flooding is successful against weed species sensitive to longer periods of submergence in water. Flooding kills plants by reducing oxygen availability for plant growth. The success of flooding depends upon complete submergence of weeds for longer periods. Flooding is done in rice fields to remove the regenerative parts of sedges.
9. **Deep ploughing** - Perennial weeds like *Cynodon dactylon*, *Cyperus sp.* *Convolvulus arvensis* can be controlled by deep ploughing and flooding with 15-30 cm of water for 4-8 weeks.
10. **Mulching** can be done in cash crops like sugarcane, cotton and flowers to control weeds.

Merits

- Oldest, effective and economical method
- Large area can be covered in shorter time
- Safe method for environment

- Does not involve any skill
- Weeding is possible in between plants
- Deep rooted weeds can be controlled effectively

Demerits

- Labour consuming
- Possibility of damaging crop
- Requires ideal and optimum specific condition

(b) **Cultural methods or cropping methods and competitive methods** - Several cultural practices like tillage, planting, fertilizer application, irrigation etc., are employed for creating favourable condition for the crop. These practices if used properly, help in controlling weeds. Cultural methods, alone cannot control weeds, but help in reducing weed population. They should, therefore, be used in combination with other methods. In cultural methods, tillage, fertilizer application, and irrigation are important. In addition, aspects like selection of variety, time of sowing, cropping system, cleanliness of the farm etc., is also useful in controlling weeds.

1. **Field preparation** - The field has to be kept weed free. Flowering of weeds should not be allowed. This helps in prevention of build up of weed seed population.
2. **Summer tillage** - The practice of summer tillage or off-season tillage is one of the effective cultural methods to check the growth of perennial weed population in crop cultivation. Initial tillage before cropping should encourage clod formation. These clods, which have the weed propagules, upon drying desiccate the same. Subsequent tillage operations should break the clods into small units to further expose the shriveled weeds to the hot sun.
3. **Optimum plant population** - Lack of adequate plant population is prone to heavy weed infestation, which becomes, difficult to control later. Therefore, practices like selection of proper seed, right method of sowing, adequate seed rate protection of seed from soil borne pests and diseases etc., are very important to obtain proper and uniform crop stand capable of offering competition to the weeds.
4. **Crop rotation** - The possibilities of a certain weed species or group of species occurring is greater if the same crop is grown year after year. In many instances, crop rotation can eliminate at least reduce difficult weed problems. The obnoxious weeds like *Cyperus rotundus* can be controlled effectively by including low land rice in crop rotation. Inclusion of smothering crop or competitive crops like sunflower, sorghum, sweet, potato, fodder grasses in rotation will effectively control the weeds. The selected crops should grow thickly and develop dense canopy and shade to suppress the weeds.

Competitive plants- *Parthenium hysterophorus* can be effectively controlled by growing *Cassia sericea* Parthenium through allelopathic effect. *Brachiaria mutica* (Para grass) is highly competitive to the growth of *Typha sp.* in ditches.

5. **Growing of intercrops** - Inter cropping suppresses weeds better than sole cropping and thus provides an opportunity to utilize crops themselves as tools of weed management. Many short duration pulses viz., green gram and soybean effectively smother weeds without causing reduction in the yield of main crop.
6. **Mulching** - Mulch is a protective covering of material maintained on soil surface. Mulching has smothering effect on weed control by excluding light from the photosynthetic portions of a plant and thus inhibiting the top growth. It is very effective against annual weeds and some perennial weeds like *Cynodon dactylon*. Mulching is done by dry or green crop

residues, plastic sheet or polythene film. To be effective the mulch should be thick enough to prevent light transmission and eliminate photosynthesis.

7. **Solarisation** - This is another method of utilization of solar energy for the desiccation of weeds. In this method, the soil temperature is further raised by 5–10°C by covering a pre-soaked fallow field with thin transparent plastic sheet. The plastic sheet checks the long wave back radiation from the soil and prevents loss of energy by hindering moisture evaporation.
8. **Stale seedbed** - A stale seedbed is one where initial one or two flushes of weeds are destroyed before planting of a crop. This is achieved by soaking a well-prepared field with either irrigation or rain and allowing the weeds to germinate. At this stage a shallow tillage or non-residual herbicide like paraquat may be used to destroy the dense flush of young weed seedlings. This may be followed immediately by sowing. This technique allows the crop to germinate in almost weed-free environment.
9. **Blind tillage** - The tillage of the soil after sowing a crop before the crop plants emerge is known as blind tillage. It is extensively employed to minimize weed intensity in drill sowing crops where emergence of crop seedling is hindered by soil crust formed on receipt of rain or irrigation immediately after sowing.
10. **Crop management practices** - Good crop management practices that play an important role in weed control are:
 - Vigorous and fast growing crop varieties are better competitors with weeds.
 - Proper placement of fertilizers ensures greater availability of nutrients to crop plants, thus keeping the weeds at a disadvantage.
 - Better irrigation practices to have a good head start over the weeds.
 - Proper crop rotation programme.
 - Higher plant population per unit area results in smothering effect on weed growth.

Merits

- Low cost for weed control
- Easy to adopt
- No residual problem
- Technical skill is not involved
- No damage to crops
- Effective weed control
- Crop-weed ecosystem is maintained

Demerits

- Immediate and quick weed control is not possible
- Weeds are kept under suppressed condition
- Perennial and problematic weeds can not be controlled
- Practical difficulty in adoption

- (c) **Biological methods** - Bio control is defined as the use of living organisms to suppress a pest population, making it less abundant and thus less damaging than that it would otherwise be or Use of living organisms *i.e.*, bioagents *viz.*, insects, disease organisms, herbivorous fish, snails or even competitive plants for the control of weeds is called biological control. In biological control method, it is not possible to eradicate weeds but weed population can be reduced. This method is not useful to control all types of weeds. Introduced weeds are best targets for biological control.

(i) Qualities of bio-agent

The bio-agent must feed or affect only one host and not other useful plants. It must be free of predators or parasites. It must readily adapt to environment conditions. The bio-agent must be capable of seeking out itself to the host. It must be able to kill the weed or at least prevent its reproduction in some direct or indirect way. It must possess reproductive capacity sufficient to overtake the increase of its host species, without too much delay.

(ii) Merits

- Least harm to the environment
- No residual effect
- Relatively cheaper and comparatively long lasting effect
- Will not affect non-targeted plants and safer in usage

(iii) Demerits

- Multiplication is costlier
- Control is very slow
- Success of control is very limited
- Very few host specific bio-agents are available at present

(iv) Mode of action

- Differential growth habits, competitive ability of crops and varieties prevent weed establishment e.g., Groundnut, cowpea fast growing and so good weed suppresser.
- Insects kill the plants by exhausting plant food reserves, defoliation, boring and weakening structure of the plant.
- Pathogenic organisms damage the host plants through enzymatic degradation of cell constituents, production of toxins, disturbance of hormone systems, obstruction in the translocation of food materials and minerals and malfunctioning of physiological processes.

Specific bio-agent will attack only one or two specific weeds. *Non specific* bioagent will feed upon variety of vegetation.

Examples:

- *Eichhornia crassipes* is controlled by using hyacinth moth (*Neconchetina eichhorniae*).
- Water fern (*Salvinia molesta*) is controlled by using curculinoid weevil (*Cryptobagous sp.*).
- *Zygogramma bicolorata*, beetle feed on leaves of *Parthenium* during monsoon.
- Larvae of *Coctoblastis cactorum*, a moth borer, control prickly pear *Opuntia sp.* The larvae tunnel through the plants and destroy it. In India it is controlled by cochinal insects *Dactylopius indicus* and *D. tomentosus*.
- *Lantana camara* is controlled by larvae of *Crocidosema lantana*, a moth bores into the flower, stems, eat flowers and fruits.
- *Cuscuta spp.* is controlled by *Melanagromyza cuscudae*.
- *Cyperus rotundus* - *Bactra verutana* a moth borer.
- *Ludiwigia parviflora* is completely denuded by *Altica cynanea* (steel blue beetle).
- Herbivorous fish Tilapia controls algae. Common carp, a non-herbivorous fish controls submerged aquatic weeds. It is apparently due to uprooting of plants while in search of food. Snails prefer submersed weeds.

(v) Bioherbicides

The use of plant pathogen, which are expected to kill the targeted weeds. Bioherbicides having pathogenic organisms like fungi, bacteria and virus are used as biocontrol agents. They are applied as chemicals. These are native pathogen, cultured artificially and sprayed just like post-emergence herbicides each season on target weed, particularly in crop areas. Fungal pathogens of weed have been used to a larger extent than bacterial, viral or nematode pathogens, because, bacteria and virus are unable to actively penetrate the host and require natural opening or vectors to initiate disease in plants. Here the specific fungal spores or their fermentation product is sprayed against the target weed. Some registered mycoherbicides in western countries are given in Table 10.5.

(d) Chemical methods - Chemicals, which can kill the weeds or control weed growth are known as herbicides. Using herbicides for the control of weeds is called chemical weed control.

Table 10.5. Registered Mycoherbicides

No.	Product	Content	Target weed
1.	Devine	A liquid suspension of fungal spores of <i>Phytophthora palmivora</i> causes root rot.	Strangle vine (<i>Morrenia odorata</i>) in citrus
2.	Collego	Wettable powder containing fungal spores of <i>Colletotrichum gloeosporoides</i> causes stem and leaf blight	Joint vetch (<i>Aeschynomone virginica</i>) in rice, soybean
3.	Bipolaris	A suspension of fungal spores of <i>Bipolaris sorghicola</i>	Jhonson grass (<i>Sorghum halepense</i>)
4.	Biolophos	A microbial toxin produced as fermentation product of <i>Streptomyces hygroscopicus</i>	Non-specific, general vegetation

i. Principle

The selectivity exhibited by certain chemicals to cultivated crops in controlling its associated weeds without affecting the crops forms basis for the chemical weed control. Such selectivity may be due to differences in the morphology, differential absorption, differential translocation, differential deactivation etc.

ii. Merits

Herbicides can be recommended for adverse soil and climatic conditions, as manual weeding is highly impossible during monsoon season. Herbicides can control weeds even before they emerge from the soil so that crops can germinate and grow in completely weed-free environment at early stages. It is usually not possible with physical weed control. Weeds, which resemble like crop in vegetative phase may escape in manual weeding. However, these weeds are controlled by herbicides. Herbicide is highly suitable for broadcasted and closely spaced crops. Herbicides control the weeds without any injury to the root system of the associated standing crop especially in plantation crops like Tea and Coffee. It reduces the need for pre planting tillage and controls many perennial weed species, which cannot be controlled by other methods. Herbicides control the weed in the field itself or *insitu* controlling where as mechanical method may lead to dispersal of weed species through seed. It is profitable where labour is scarce and expensive. Herbicide application is well suited for minimum tillage concept and it provides early season/zero day weed control and its application is highly economical.

III. Demerits

- Pollutes the environment
- Herbicides must be applied at proper time in each season
- Excess herbicide residues in soils may affect succeeding crop
- It requires certain minimum technical knowledge for selection and use of herbicides
- Affects the soil microbes if the dose exceeds
- Herbicide causes drift effect to the adjoining field
- It requires certain amount of minimum technical knowledge for calibration
- Leaves residual effects
- Some herbicide is highly costlier
- Suitable herbicides are not available for mixed and inter-cropping system.

IV. Classification of herbicides

1. Based on method of application

Soil applied herbicides: Herbicide act through root and other underground parts of weeds *e.g.*, Fluchloralin.

Foliage applied herbicides: Herbicide primarily active on the plant foliage *e.g.*, Glyphosate, Paraquat.

Factors influencing the methods of application are weed-crop situation, type of herbicides, mode of action and selectivity, environmental factors and cost and convenience of application. Based on method of application, herbicides can be grouped as below.

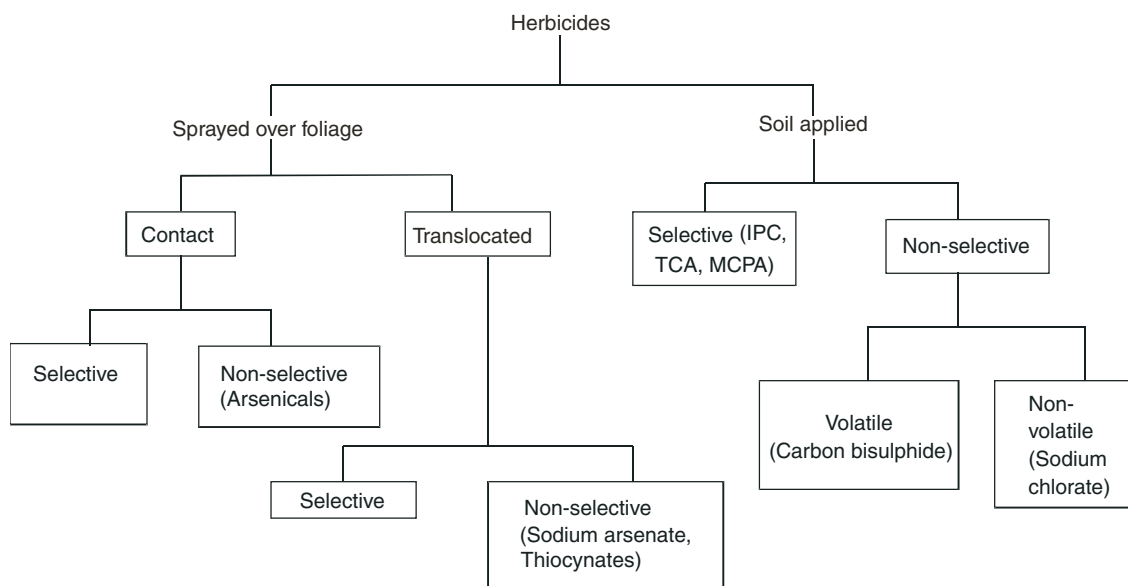

Fig. 10.1

Selective herbicides will not affect the crop but will kill the weeds. Non-selective herbicides will kill all plants on which it is sprayed or applied. It is also known as total killer. Example—paraquat, glyphosate etc.

2. Based on target site

Depending on the target site, the herbicides are classified into soil applied herbicides and foliage applied or foliar herbicides.

<i>Soil application</i>	<i>Foliar application</i>
(a) Surface	(i) Blanket spray
(b) Sub surface	(ii) Directed spray
(c) Band	(iii) Protected spray
(d) Fumigation	(iv) Spot treatment
(e) Herbigation	

Soil application

- (a) *Surface application* - Soil active herbicides are applied uniformly on the surface of the soil either by spraying or by broadcasting. The applied herbicides are either left undisturbed or incorporated into the soil. Incorporation is done to prevent the volatilization and photo-decomposition of the herbicides. *e.g.*, Fluchoralin—Left undisturbed under irrigated condition and incorporated under rainfed condition.
- (b) *Subsurface application* - It is the application of herbicides in a concentrated band, about 7–10 cm below the soil surface for controlling perennial weeds. For this special type of nozzle is introduced below the soil under the cover of a sweep hood. *e.g.*, Carbamate herbicides to control *Cyperus rotundus* and Nitratin herbicides to control *Convolvulus arvensis*.
- (c) *Band application* - Application to a restricted band along the crop rows leaving an untreated band in the inter-rows. Later inter-rows are cultivated to remove the weeds. Saving in cost is possible here. For example when a 30 cm wide band of a herbicide applied over a crop rows that were spaced 90 cm apart, then two-third cost is saved.
- (d) *Fumigation* - Application of volatile chemicals into confined spaces or into the soil to produce gas that will destroy weed seeds is called fumigation. Herbicides used for fumigation are called as fumigants. These are good for killing perennial weeds and as well for eliminating weed seeds. *E.g.*, Methyl bromide, Metham, etc.
- (e) *Herbigation* - Application of herbicides with irrigation water both by surface and sprinkler systems. In India farmers apply fluchloralin for chillies and tomato, while in western countries application of EPTC with sprinkler irrigation water is very common in Lucerne.

1. Foliar application

- (i) **Blanket spray** - Uniform application of herbicides to standing crops without considering the location of the crop. Only highly selective herbicides are used here. *e.g.*, Spraying 2,4-Ethyl Ester to rice three weeks after transplanting
- (ii) **Directed spray** - Application of herbicides on weeds in between rows of crops by directing the spray only on weeds avoiding the crop. This could be possible by use of protective shield or hood. For example, spraying glyphosate in between rows of tapioca using hood to control *Cyperus rotundus*.
- (iii) **Protected spray** - Applying non-selective herbicides on weeds by covering the crops, which are wide spaced, with polyethylene covers etc. This is expensive and laborious. However, farmers are using this technique for spraying glyphosate to control weeds in jasmine, cassava, banana etc.

- (iv) **Spot treatment** - It is usually done on small areas having serious weed infestation to kill it and to prevent its spread. Rope wick applicator and Herbicide glove are useful here.

2. Based on mode of action

Selective herbicide - A herbicide is considered as selective when in a mixed growth of plant species, it kills some species without injuring the others. *e.g.*, Atrazine.

Non-selective herbicide - It destroys majority of treated vegetation *e.g.*, Paraquat.

3. Based on mobility

Contact herbicide - A contact herbicide kills those plant parts with which it comes in direct contact *e.g.*, Paraquat.

Translocated herbicide - Herbicide which tends to move from treated part to untreated areas through xylem/phloem depending on the nature of its molecule *e.g.*, Glyphosate.

4. Based on time of application

Pre-plant application (PPI): Application of herbicide before sowing or along with sowing. Either it is foliar applied or incorporated in soil soon after its application. Pre-plant foliar spraying of glyphosate to control perennial weeds like *Cyperus rotundus* and pre-plant soil incorporation of Fluchloralin to control weeds in ground nut.

Pre-emergence: Herbicide is applied to soil soon after sowing a crop before emergence of weeds. *e.g.*, Atrazine, Pendimethalin, Butachlor, Thiobencarb, Pretilachlor etc.

Post-emergence: When herbicide is applied to kill young weeds standing in the crop plants or application after the emergence of weed and crop. *e.g.*, Glyphosate, Paraquat, 2,4-D Na Salt.

Early post emergence: Another application of herbicide in the slow growing crops like potato, sugarcane, 2-3 week after sowing is classified as early post emergence.

5. Based on molecular structure

- (a) Inorganic compounds
- (b) Organic compounds

V. Formulations

Herbicides in their natural state may be solid, liquid, volatile, non-volatile, soluble or insoluble. Hence, these have to be made in forms suitable and safe for their field use. An herbicide formulation is prepared by the manufacturer by blending the active ingredient with substances like solvents, inert carriers, surfactants, stickers, stabilizers etc. The objectives in herbicide formulations are as follows:

- Ease of handling
- High controlled activity on the target plants

(a) Need

To have a product with physical properties suitable for use in a variety of types of application equipment and conditions; to prepare a product, which is effective and economically feasible to use and to prepare a product, which is suitable for storage under local conditions?

(b) Types of formulation

- (i) **Emulsifiable concentrates (EC)** - A concentrated herbicide formulation containing organic solvent and adjuvants to facilitate emulsification with water *e.g.*, Butachlor.

- (ii) **Wettable powders (WP)** - A herbicide is absorbed by an inert carrier together with an added surface acting agent. The material is finely ground so that it may form a suspension when agitated with a required volume of water *e.g.*, Atrazine.
- (iii) **Granules (G)** - The inert material (carrier) is given a granular shape and the herbicide (active ingredient) is mixed with sand, clay, vermiculite, finely ground plant parts (ground corn cobs) as carrier material. *e.g.*, Alachlor granules.
- (iv) **Water soluble concentrates (WSC)** *e.g.*, paraquat.

VI. Time of application of herbicides

- (i) **Pre-planting** - Application of herbicides before the crop is planted or sown. Soil application as well as foliar application is done here. For example, fluchloralin can be applied to soil and incorporated before sowing rainfed groundnut while glyphosate can be applied on the foliage of perennial weeds like *Cyperus rotundus* before planting of any crop.
- (ii) **Pre-emergence** - Application of herbicides before a crop or weed has emerged. In case of annual crops application is done after the sowing of the crop but before the emergence of weeds and this is referred as pre-emergence to the crop while in the case perennial crops it can be said as pre-emergence to weeds. For example soil application by spraying of atrazine on 3rd DAT to sugarcane can be termed as pre-emergence to cane crop while soil application by spraying the same immediately after a rain to control a new flush of weeds in a inter-cultivated orchard can be specified as pre-emergence to weed.
- (iii) **Post-emergence** - Herbicide application after the emergence of crop or weed is referred as post-emergence application. When the weeds grow before the crop plants have emerged through the soil and are killed with a herbicide then it is called as early post-emergence. For example spraying 2,4-D Na salt to control parasitic weed striga in sugarcane is called as post-emergence while spraying of paraquat to control emerged weeds after 10-15 days after planting potato can be called as early post-emergence.

VII. Selective herbicides

The success of weed control programme depends on study of weed flora, selection of proper herbicide, use of correct dose, stage and time of application, method of application and calibration of sprayer.

(a) Factors influencing choice of herbicides

Crop factor - Monocots and dicots show differential tolerance to a herbicide, accordingly depending on type of crop cultivated the choice of herbicides varies. *e.g.*, Monocots like rice has tolerance to 2,4-D Na salt while dicots like soybean gets killed when used as post-emergence.

Nature of weeds present - Based on the type of major weeds present in a situation, the herbicides are suggested accordingly. For *e.g.*, if more grassy weeds-fluzipop butyl is used while 2,4-D Na salt is used to control broad-leaved weeds.

Site of application - Soil applied herbicides–Atrazine, fluchloralin; Foliar applied herbicides–glyphosate.

Time of application - Pre-emergence herbicides–metolachlor ; Post-emergence herbicides–paraquat.

Farming situation - Wetland–water soluble herbicides butachlor; garden land–Wettable powders–Atrazine and water bodies–Diquat.

Duration of weed control - Short duration–less persistent herbicide-Anilofos; Long period –residual herbicides–atrazine.

Cropping system

- Maize + pulse combination–Isoproturon used and not atrazine
- Maize followed by pulse use pendimethalin
- Maize followed by cereal-Atrazine

Cost - In case of rice though butachlor, fluchloralin, pendimethalin etc., are recommended mostly butachlor is used because of it is cheaper than all other chemicals but not in control of weeds.

(b) Herbicides for important crops

The important herbicides for different crops are given in Table 10.6.

Table 10.6. Herbicides for Important Crops

<i>Crop</i>	<i>Herbicide</i>	<i>Dose (kg a.i./ha)</i>	<i>Trade name and formulation</i>	<i>Time of application</i>
1. Rice	Butachlor	1.25	Machete 50% EC Delchlor 50% EC	Pre-emergence
	Thiobencarb	1.25	Thunder 50% EC Saturn 50% EC	Pre-emergence
	Anilophos	0.40	Arozin 30% EC Aniloguard 30% EC	Pre-emergence
	Fluchloralin	0.90	Basalin 45% EC	Pre-emergence
	Pendimethalin 2,4-D Na salt	0.90 1.00	Stomp 30% EC Fernoxone 80% SS	Pre-emergence Post-emergence
2. Rice (Upland direct sown)	Thiobencarb	1.25	Saturn 50% EC	Pre-emergence (8 DAS)
	Pretilachlor	0.45	Refit 50% EC	Pre-emergence
3. Sorghum	Atrazine	0.25	Atrataf 50% WDP	Pre-emergence
4. Ragi (Transplanted)	Butachlor	1.25	Machete 50% EC	Pre-emergence
	Pendimethalin	0.75	Stomp 30% EC	Pre-emergence
5. Maize	Atrazine	0.25	Atrataf 50% WDP	Pre-emergence
6. Cumbu	Atrazine	0.25	Atrataf 50% WDP	Pre-emergence
7. Cotton	Metolachlor	1.00	Dual 50% EC	Pre-emergence
	Fluchloralin	1.00	Basalin 45% EC	Pre-emergence
	Pendimethalin	1.00	Stomp 30% EC	Pre-emergence
	Diuron	0.40	Karmex 50% WP	Pre-emergence
8. Groundnut	Metolachlor	1.00	Dual 50% EC	Pre-emergence
	Fluchloralin	0.90	Basalin 45% EC	Pre-emergence
9. Sunflower	Fluchloralin	0.90	Basalin 45% EC	Pre-emergence
	Pendimethalin	0.90	Stomp 30% EC	Pre-emergence
10. Vegetables	Fluchloralin	1.00	Basalin 45% EC	Pre-emergence
	Pendimethalin	1.00	Stomp 30% EC	Pre-emergence
11. Sugarcane	Atrazine	1.00	Atrataf 50% WDP	Pre-emergence

(Contd.)

<i>Crop</i>	<i>Herbicide</i>	<i>Dose (kg a.i./ha)</i>	<i>Trade name and formulation</i>	<i>Time of application</i>
12. Pulses	Fluchloralin	0.70	Basalin 45% EC	Pre-emergence
	Pendimethalin	0.60	Stomp 30% EC	Pre-emergence
13. Wheat	Isoproturon	0.60	Arelon 75% WP	Pre-emergence
<i>Cropping Systems</i>				
1. Sorghum + Cowpea	Pendimethalin	0.90	Stomp 30% EC	Pre-emergence
2. Sugarcane + Pulses	Thiobencarb	1.25	Saturn 50% EC	Pre-emergence
3. Maize + Soybean	Pendimethalin	1.00	Stomp 30% EC	Pre-emergence
	Alachlor	2.00	Lasso 50% EC	Pre-emergence

*Subject to change. This recommendation is for Tamil Nadu conditions.

10.8 INTERACTION OF HERBICIDES WITH MOISTURE, FERTILIZERS, BIO FERTILIZERS, INSECTICIDES AND FUNGICIDES

Simultaneous or sequential application of herbicides, insecticides, fungicides, antidotes, fertilizers etc. are followed in a single cropping season. These chemicals may undergo a change in physical and chemical characters, which could lead to enhancement or reduction in the efficacy of one or more compounds. The interaction effects were seen much later in the growing season or in the next season due to build up of persistent chemicals or their residues in the soil. Knowledge on the interactions of various chemicals can be helpful in the formulation and adoption of a sound and effective plant protection programme. It can also help to exploit the synergistic and antagonistic interactions between various pesticides for an effective eradication of weed and other pest problems. When two or more chemicals accumulate in the plant, they may interact and bring out responses. These responses are classified as additive, synergistic, antagonistic, independent and enhancement effects.

A. Interaction Effects

Additive effect - It is the total effect of a combination, which is equal to the sum of the effects of the components taken independently.

Synergistic effect - The total effect of a combination is greater or more prolonged than the sum of the effects of the two taken independently. *e.g.*, The mixture of 2,4-D and chlorpropham is synergistic on monocot species generally resistant to 2,4-D. Similarly, low rates of 2,4-D and picloram have synergistic response on *Convolvulus arvensis*. Atrazine and Alachlor combination, which shows synergism is widely used for an effective control in corn.

Antagonistic effect - The total effect of a combination is smaller than the effect of the most active component applied alone. *e.g.*, combination of EPTC with 2,4-D, 2,4,5-T or dicamba has antagonistic responses in sorghum and giant foxtail. Similarly, chlorpropham and 2,4-D have antagonism. When simazine or atrazine is added to glyphosate solution and sprayed the glyphosate activity is reduced. This is due to the physical binding within the spray solution rather than from biological interactions within the plant.

Independent effect - The total effect of a combination is equal to the effect of the most active component applied alone.

Enhancement effect - The effect of a herbicide and non-toxic adjuvant applied in combination on a plant is said to have an enhancement effect if the response is greater than that obtained when the herbicide is used at the same rates without the adjuvant. *e.g.*, mixing Ammonium sulphate with glyphosate.

B. Herbicide-moisture Interaction

Soil applied herbicides fail when there is a dry spell of 10-15 days after their application. Pre-emergence herbicides may be lost by photo-decomposition, volatilization and wind blowing while some amount of water is desirable to activate the soil applied herbicides, excess of it may leach the herbicide to the crop seed and root zone. This may injure the crops and on other side, result in poor weed control. Heavy showers may wash down herbicides from the foliage. Continuous wet weather may induce herbicide injury in certain crops by turning them highly succulent. *e.g.*, maize plants are normally tolerant to Atrazine but they become susceptible in wet weather, particularly when air temperature is low. Extra succulence has been found to increase atrazine absorption and low temperature decrease its metabolism inside the plants. Quality of water used may also determine herbicide action. Dusty water reduces action of paraquat. Calcium chloride rich water reduces glyphosate phytotoxicity.

C. Herbicide-insecticide Interaction

These chemicals are usually not harmful at recommended rates. The tolerance of plants to a herbicide may be altered in the presence of an insecticide and vice versa. The phyto-toxicity of monuron and diuron on cotton and oats is increased when applied with phorate. Phorate interacts antagonistically with trifluralin to increase cotton yield, by stimulating secondary roots in the zone of pesticide incorporation. Propanil interacts with certain carbamate and phosphate insecticides used as seed treatments on rice. But chlorinated hydrocarbon insecticides as seed treatment have not interacted with propanil. When propanil is applied at intervals between 7 and 56 days after carbofuron treatment, it results in greater injury to rice vegetatively.

D. Herbicide-pathogens/fungicides Interaction

Herbicides interact with fungicides also. Dinoseb reduces the severity of stem rot in groundnut. In sterilized soil, chloroxuron is not causing any apparent injury to pea plants, while in the presence of *Rhizoctonia solani* in unsterilized soil it causes injury. Oxadiazon reduces the incidence of stem rot caused by the soil borne pathogen *Sclerotium rolfsii* L. in groundnut. Diuron and triazine, which inhibit photosynthesis, may make the plants more susceptible to tobacco mosaic virus. On the other hand, diuron may decrease the incidence of root rot in wheat.

E. Herbicide-fertilizer Interaction

Herbicides have been found to interact with fertilizers in fields. *e.g.*, fast growing weeds that are getting ample nitrogen show great susceptibility to 2, 4-D, glyphosate than slow growing weeds on poor fertility lands. The activity of glyphosate is increased when ammonium sulphate is tank mixed. Nitrogen invigorate (put life and energy into) the meristematic activity in crops so much that they susceptible to herbicides. High rates of atrazine are more toxic to maize and sorghum when applied with high rates of phosphorus.

F. Herbicide-microbes Interaction

Microorganisms play a major role in the persistence behaviour of herbicides in the soil. The soil microorganisms have the capacity to detoxify and inactivate the herbicides present in the soil. Some

groups of herbicides more easily degrade through microbes than others. The difference lies in the molecular configuration of the herbicide. The microorganisms involved in herbicide degradation include bacteria, fungi, algae, moulds etc. Of these, bacteria predominate and include the members of the genera *Agrobacterium*, *Arthrobacter*, *Achromobacterium*, *Bacillus*, *Pseudomonas*, *Streptomyces*, *Flavobacterium*, *Rhizobium* etc. The fungi include those of the genera *Fusarium*, *Penicillium* etc.

10.9 INTEGRATED WEED MANAGEMENT (IWM)

A. Definition

Use of a judicious combination of mechanical, cultural, biological and chemical methods to achieve economic and effective weed control. It is a method whereby all economically, ecologically and toxicologically justifiable methods are employed to keep the harmful organisms below the threshold level of economic damage, keeping in the foreground the conscious employment of natural limiting factors.

IWM is the rational use of direct and indirect control methods to provide cost-effective weed control. Such an approach is the most attractive alternative from agronomic, economic and ecological point of view. Among the commonly suggested indirect methods are land preparation, water management, plant spacing, seed rate, cultivar use, and fertilizer application. Direct methods include manual, cultural, mechanical and chemical methods of weed control. The essential factor in any IWM programme is the number of indirect and direct methods that can be combined economically in a given situation. For example, increased frequency of ploughing and harrowing does not eliminate the need for direct weed control. It is, therefore, more cost-effective to use fewer pre-planting harrowing and combine them with direct weed control methods. There is experimental evidence that illustrates that better weed control is achieved if different weed control practices are used in combination rather than if they are applied separately.

B. Why IWM

- One method of weed control may be effective and economical in a situation and it may not be so in other situation.
- No single herbicide is effective in controlling wide range of weed flora.
- Continuous use of same herbicide creates resistance in escaped weed flora or causes shift in the flora.
- Continuous use of only one practice may result in some undesirable effects. *e.g.*, Rice–wheat cropping system–*Philaris minor*.
- Only one method of weed control may lead to increase in population of particular weed.
- Indiscriminate herbicide use and its effects on the environment and human health.

C. Concept

- Uses a variety of technologies in a single weed management with the objective to produce optimum crop yield at a minimum cost taking into consideration ecological and socio-economic constraints under a given agro-ecosystem.
- A system in which two or more methods are used to control a weed. These methods may include cultural practices, natural enemies and selective herbicides.

D. Good IWM should be

- Flexible enough to incorporate innovations and practical experiences of local farmers.

- Developed for the whole farm and not for just one or two fields and hence it should be extended to irrigation channels, road sides and other non-crop surroundings on the farm from where most weeds find their way into the crop fields.
- Economically viable and practically feasible.

E. Advantages of IWM

- It shifts the crop-weed competition in favour of crop
- Prevents weed shift towards perennial nature
- Prevents resistance in weeds to herbicides
- No danger of herbicide residue in soil or plant
- Suitable for high cropping intensity

IWM for different crops are given in the chapter 15.

A Conceptual Model of IWM by Noda, K. (1977)

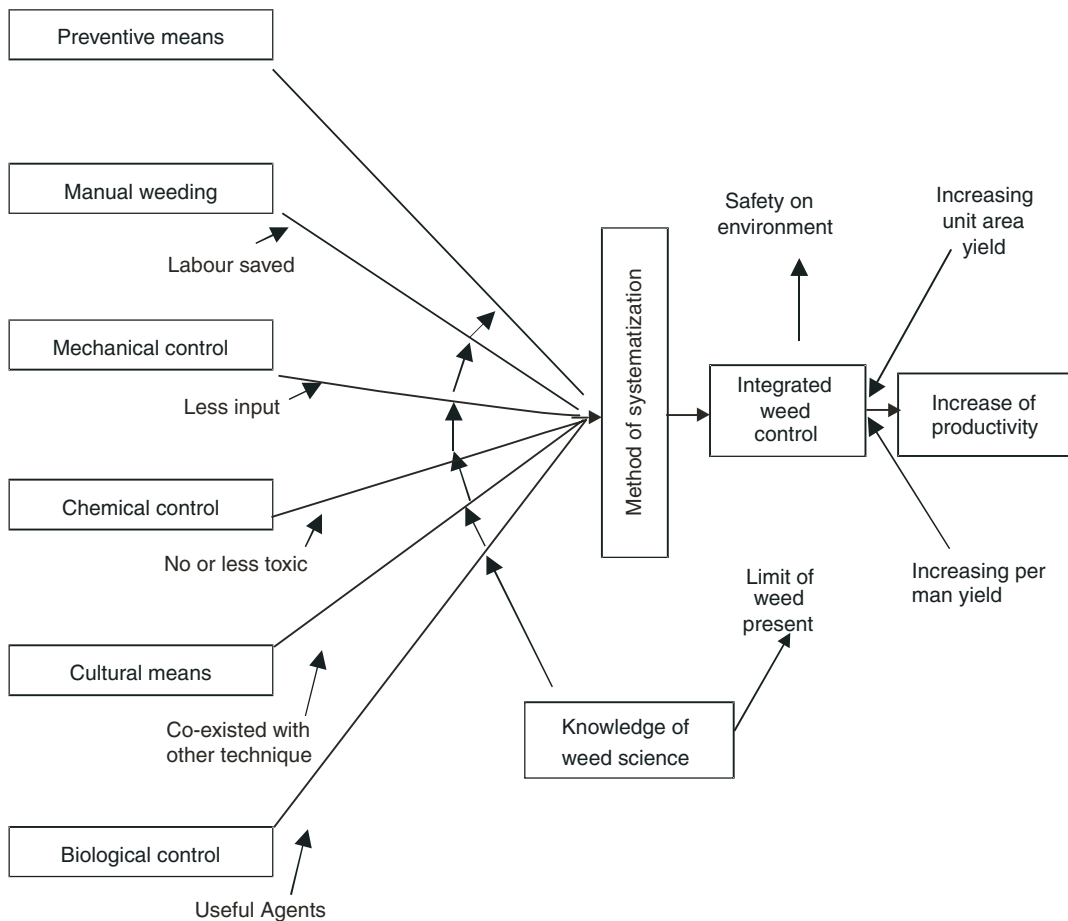

Fig. 10.2

10.10 HERBICIDE MIXTURES

Involves mixing of two or more herbicides used for effective and economical weed control.

A. Advantages

- A mixture will broaden the spectrum of herbicidal action and kill a variety of weeds.
- It may increase the effectiveness.
- In a mixture one herbicide may prevent rapid degradation of the other and increase its efficacy.
- A mixture offers the possibility of reducing the dose of each of the herbicide necessary for weed control leading to low residue.

B. Two types of Mixtures

- (i) Tank mixtures made with the desired herbicides and rates before application *e.g.*, Anilophos + 2,4-D EE-rice.
- (ii) Ready mix—formulated by the manufacturer. Ready mix available in the world market *e.g.*, 2,4-D+Glyphosate, Paraquat+2,4,-D, Atrazine+metolachlor, paraquat+oxyfluorfen.

10.11 HERBICIDE ROTATION

The practice of following a systematic, rotational sequence of herbicide used in the same field to prevent or control formation of herbicide resistant weeds. In a rotational programme a soil-applied or foliage applied herbicide or both are used in a sequence to take care of annual as well as perennial weeds. The choice of herbicide depends on the tolerance of crops to particular herbicides, type of weed spectrum, intensity of weed infestation, soil and climatic factors etc. The best rotational programme will aim at maximum cumulative cost benefit ratio and least residual problems and least build-up of tolerant weeds.

Advantages

- Helps in preventing emergence of tolerant weed species (Herbicide is captured in vacuole and inactivated excluding the herbicide from site of action).
- Reduces the quantities of herbicide required for optimum weed control over the years.
- Provides most effective weed control for the duration of crop growth.
- Reduces the building up of herbicide residue problems.
- It offers high cumulative cost-benefit ratio over the years.

Weed survey and mapping may be done every year and if any shift in weed flora, appropriate changes in herbicide rotation should be made.

10.12 HERBICIDE TOLERANCE AND RESISTANCE

A. Herbicide Resistance

Naturally occurring inheritable ability of some weed biotypes within a population to survive a herbicide treatment that would, under conditions of use effectively control the weed population (Rubin, 1991).

- *Senecio vulgaris* resistance to triazine group of herbicide was noticed during 1970
- Worldwide 183 weeds have developed resistance to herbicides till 1997
- In India the most common example is *Philaris minor*

- The highest resistance in 61 weed species was recorded for atrazine
- USA alone found to have 49 herbicide resistant weeds, the highest in the world.
- (i) **Gross resistance** - When a weed biotype exhibits resistant to two or more herbicides due to the presence of a single herbicide mechanism.
- (ii) **Multiple resistance** - It is a situation where resistant plants possess two or more distinct resistant mechanisms to a single herbicide or groups of herbicides.

Basic principles

- Time, dose and method of application of herbicide variation
- Variation in phenotypes of a population
- Genetic variation by mutation or activation of pre existing genes

Conditions favourable

- Repeated use of same herbicide or use of herbicide with same mode of action due to the practices of monoculture
- Areas where minimum/zero tillage is followed
- Fields where farmers rely on only herbicides for high degree/level of weed control including nurseries, orchards
- Non-crop situations like road sides, railway tracks etc., where herbicides are repeatedly used may be at higher doses than cropped situation

Resistance was exhibited in crop is due to herbicide metabolism by crops making them inactive, absence of certain metabolic process in crops compared to weeds and thus tolerating the herbicides and crops couples the herbicide molecule.

B. Tolerance - The term tolerance refers to the partial resistance and presently the usage of the term is discouraged due to inconsistency in quantifying the degree of tolerance.

10.13 HERBICIDE ANTIDOTE

Chemicals, which are used to inactivate the applied herbicides, are called as antidotes. *e.g.*, Paraquat spray can be inactivated by spraying 1% ferric chloride.

10.14 SAFENERS/PROTECTANTS

Substances used for protecting crop plants, which are otherwise susceptible or less tolerant to some herbicides at doses required for good weed control.

e.g., Naphthalic anhydride (NA)–0.5 g/kg of seed for rice to protect against molinate and alachlor
R–27788–soil application protects maize from alachlor and metolachlor

Mode of Action: Safeners enter the target plants and compete there with herbicide molecules for a binding site on some native enzyme.

10.15 ADJUVANTS

Adjuvants are chemicals employed to improve the herbicidal effects, sometimes making a difference between satisfactory and unsatisfactory weed control.

Mode of Action: Adjuvants aid the herbicide availability at the action site in plants.

Kinds of adjuvants

1. Surfactant (Surface active agents)

- Aid in wetting the waxy leaf surface with aqueous herbicide sprays (wetting agents)
- In spreading the hydrophilic herbicides uniformly over the foliage (spreaders)
- In the penetration of herbicide into the target leaves and stems (penetrates)

A water drop is held as a ball on a waxy leaf surface. (Take water in a beaker, if you dip a leaf of *Cynodon dactylon* and pull it back, you can see the leaf without wetting. But if you add a drop of surfactant you can readily wet the foliage.). With the addition of surfactant, the water drop flattens down to wet the leaf surface and let the herbicide act properly.

2. Stabilizing agents - These include emulsifiers and dispersing agents.

- (i) **Emulsifiers** - A substance which stabilizes (reduces the tendency to separate) a suspension of droplets of one liquid which otherwise would not mix with the first one. It substitutes for constant agitation of spray liquids during field operation.
E.g., ABS, Solved, 15-5-3, 15-5-9.
- (ii) **Dispersing agents** - They stabilize suspensions. They keep fine particles of wettable powder in suspension in water even after initial vigorous agitation has been withdrawn. They act by increasing the hydration of fine particles of WP laden with the herbicides.

3. Coupling agents (Solvents and co-solvents) - Chemical that is used to solubilize a herbicide in a concentrated form; the resulting solution is soluble with water in all proportions. *e.g.*, 2,4-D is insoluble in water, but it can be dissolved in polyethylene glycol to make it water soluble.

Common solvents: Benzene, acetone, petroleum ether, carbon tetrachloride.

4. **Humicants (Hygroscopic agents)** - Humicants prevent rapid drying of herbicide sprays on the foliage, thus providing an extended opportunity of herbicide absorption *e.g.*, glycerol.
5. **Deposit builders (Stickers or filming agents)** - Chemicals added to herbicide concentrates to hold the toxicant in intimate contact with the plant surface. They also reduce washing off of the toxicant from the treated foliage by rain. *e.g.*, several petroleum oils, Dupont spreader sticker, Citowett.
6. **Compatibility agents** - Used to intimately mix fertilizers and pesticides in spray liquids *e.g.*, Compex.
7. **Activators (Synergists)** - Chemicals having cooperative action with herbicides that the resultant phytotoxicity is more than the effect of the two working independently. *e.g.*, Paraffinic oils, Ammonium thiocyanate, Urea and Ammonium chloride to enhance 2,4-D phytotoxicity.
8. **Drift control agents** - Herbicide spray drifts may pose serious hazards to non-target plants. *e.g.*, 2,4-D on cotton. Solution is to spray herbicide liquids in large droplets.
9. **Thickening agents** *e.g.*, (Decagin, Sodium alginate).

10.16 MANAGEMENT OF HERBICIDE RESIDUES IN SOIL

An ideal soil applied herbicide should persist long enough to give an acceptable period of weed control but not so long that soil residues after crop harvest limit the nature of subsequent crops which can be grown. Various management techniques have been developed which can help to minimise the residue hazards in soil.

A. Use of Optimum Dose of Herbicide

Hazards from residues of herbicides can be minimized by the application of chemicals at the lowest dosage by which the desired weed control is achieved. Besides, applying herbicides in bands rather as broadcast will reduce the total amount of herbicide to be applied. This will be practicable in line sown crops or crops raised along ridges, such as cotton, sugarcane, sorghum, maize etc.

B. Application of Farm Yard Manure

Farmyard manure application is an effective method to mitigate the residual toxicity of herbicides. The herbicide molecules get adsorbed in their colloidal fraction and make them unavailable for crops and weeds. Besides, FYM enhances the microbial activity, which in turn degrades the herbicide at a faster rate.

C. Ploughing/cultivating the Land

Ploughing with disc plough or intercultivators reduces the herbicide toxicity, as the applied herbicide is mixed to a large volume of soil and gets diluted. In case of deep ploughing the herbicide layer is inverted and buried in deeper layers and thereby the residual toxicity got reduced.

D. Crop Rotation

Ragi–Cotton–Sorghum is the common crop rotation under irrigated field conditions of Coimbatore district. Fluchloralin 0.9 kg or butachlor 0.75 kg/ha + Hand weeding at 35 DAT for ragi + sunflower (border crop), pendimethalin 1.0 kg/ha + hand weeding on 35 DAS for cotton intercropped with onion and two manual weeding at 15 and 35 DAS for sorghum inter cropped with cowpea is the recommended weed control practice. The above weed management schedule did not show any residual effect in the cropping system because the herbicides are changed for every crop.

E. Use of Non-Phyto-Toxic Oil

Atrazine residual hazard could be reduced by mixing non-phyto-toxic oil, which would also enhance the weed killing potency.

F. Use of Activated Carbon

Activated carbon has a high adsorptive capacity because of its tremendous surface area which vary from 600–1200 m²/g. Incorporation of 50 kg/ha of activated charcoal inactivated completely chlorsulfuron applied at 1.25 and 2.50 kg/ha and did not affect the yield of maize compared to untreated control. Application of charcoal at 5.0 kg/ha along the seed line reduced the residual toxicity of atrazine in soybean crop.

G. Use of Safeners and Antidotes

A new development in herbicide usage is the use of safeners and antidotes in order to protect the crop plant from possible damage by a herbicide. This means that it may be possible to use certain herbicides on crops that would normally be affected by herbicide. NA (1,8-naphthalic anhydride) has been used as a seed dressing on rice to protect the crop against molinate and alachlor. Another herbicide safener cyometrinil is used along with metolachlor in grain sorghum and other crop species.

H. Leaching the Soil

Leaching the herbicide by frequent irrigation is possible especially in case of water soluble herbicides. In this case, the herbicides are leached down to lower layers *i.e.*, beyond the reach of the crop roots.

Irrigation and Water Management

Plants and any form of living organisms cannot live without water, since water is the most important constituent of about 80-90% of most plant cell. Water is essential not only to meet agricultural needs but also for industrial purposes, power generation, live stock maintenance, rural and domestic needs etc. But the resource is limited and cannot be created as we require.

11.1 IMPORTANCE OF WATER

A. Physiological Importance

- The plant system itself contains about 90% of water.
- Amount of water varies in different parts of plant as follows.
 - * Apical portion of root and shoot > 90%.
 - * Stem, leaves and fruits 70–90%
 - * Woods 50–60%
 - * Matured parts 15–20%
 - * Freshly harvested grains 15–20%
- It acts as base material for all metabolic activities. All metabolic or biochemical reactions in plant system need water.
- It plays an important role in respiration and transpiration.
- It plays an important role in photosynthesis.
- It activates germination and plays an important role in plant metabolism for vegetative and reproductive growth.
- It serves as a solvent in soil for plant nutrients.
- It also acts as a carrier of plant nutrients from soil to plant system.
- It maintains plants temperature through transpiration.
- It helps to keep the plant erect by maintaining plant's turgidity.
- It helps to transport metabolites from source to sink.

B. Ecological Importance

- It helps to maintain soil temperature.
- It helps to maintain salt balance.
- It reduces salinity and alkalinity.
- It influences weed growth.
- It influences atmospheric weather.

- It helps the beneficial microbes.
- It supports human and animal life.
- It helps for land preparation like ploughing, puddling etc., weeding, fertilizer application etc., by providing optimum conditions.

The multivarious uses of good quality water for the purpose of irrigation, industrial purpose, power generation, livestock use, and domestic use for urban and rural development are increasing the demand for water. Due to increasing cost of irrigation projects and limited supply of good quality water, it becomes a highly valuable commodity and hence it is stated as **liquid Gold**. As indicated by Sir. C.V. Raman, water is the ELIXIR of life which makes wonders on earth if it is used properly, efficiently, economically, environmentally safely, optimally and equitably. Further, historical evidences indicate that all civilization established on riverbanks due to proper management and disappear due to improper management of the same water base. All the superior varieties, organic manure, inorganic fertilizer, efficient labour saving implements, proper pest and diseases management techniques can be implemented only when sufficient water is applied to the crop. The diversified value of water can be quoted as follows.

- Water as a source of sustenance
- Water as an instrument of agriculture
- Water as a community good
- Water as a mean of transportation
- Water as an industrial commodity
- Water as a clean and pure resource
- Water as a beauty
- Water as a destructive force to be controlled
- Water as a fuel for urban development
- Water a place for recreation and wild life habitat.

11.2 IMPORTANCE OF IRRIGATION MANAGEMENT

Irrigation is the artificial application of water made for supplementing the moisture in the soil that is deficient and does not meet the full requirements of growing crops. Irrigation is essentially a practice of supplementing the natural precipitation for increasing production of agricultural and horticultural crops.

(a) *Effective irrigation* - It is the controlled and uniform application of water to cropland in required amount at the required time, to produce optimum yields. The cost of irrigation must be kept minimum and irrigation should be done without any wastage of water, which may cause adverse effect on the soil in the form of soil salinity and water logging problems. Almost all major crops are grown under irrigated condition. The most important one is rice in Tamil Nadu, which constitutes 67.5% of the total area under irrigation. The crops irrigated with flow irrigation from rivers and tanks are mostly rice and sugarcane and to a smaller extent banana and turmeric.

(b) *Irrigation management* - Regulating the activities based on the various resources for its efficient use and better out put *i.e.*, allocation of all the resources for maximum benefit and to achieve the objectives, without eroding the environment is called management. Otherwise, it can be stated as planning, executing, monitoring, evaluating and re-organizing the whole activities to achieve the target. Management of water based on the soil and crop environment to obtain better yield by efficient use of

water without any damage to the environment. Management of water, soil, plants, irrigation structure, irrigation reservoirs, environment, social set up and its inter liked relationship are studied in the irrigation management. Knowledge on the following aspects is necessary to device proper irrigation management.

- The soil physical and chemical properties,
- Biology of crop plants,
- Quantity of water available,
- Time of application of water,
- Method of application of water,
- Climatological or meteorological influence on irrigation, and
- Environment and its changes due to irrigation.

Management of all the above said factors constitute **Irrigation Agronomy**; Management of irrigation structures, conveyances, reservoirs constitute **Irrigation Engineering**; and social set up, activities, standard of living, irrigation policies, irrigation association and farmer's participation, cost of irrigation etc., constitute **Socio-economic** study.

Irrigation management is a complex process of art and science involving application of water from source to crop field. The source may be a river or a well or a canal or a tank or a lake or a pond. Maintaining the irrigation channels without leakage and weed infestation, applying water to field by putting some local check structure like field inlet and boundaries for the area to be irrigated etc., need some skill. These practices are the art involving practices in irrigation management. Time of irrigation and quantity of water to be applied (when to irrigate? and how much to irrigate?) based on soil types, climatic parameters, crop, varieties, growth stages, season, quality of water, uptake pattern of water by plants, etc., and method of application (How best to irrigate) includes conveyance of water without seepage and percolation losses and water movement in soil, are the process involving scientific irrigation management. Simply, it is a systematic approach of art and science involved in soil, plant and water by proper management of the resources (soil, plant and water) to achieve the goal of crop production.

(c) *Importance* - Irrigation management is very important

- To the development of nation through proper management of water resources for the purpose of crop production and other activities such as industrialization, power generation etc., which in turn provides employment opportunities and good living condition of the people.
- To store and regulate the water resources for further use or non-season use.
- To allocate the water with proper proportion based on area and crop under cultivation. (Balanced equity in distribution).
- To convey the water without much loss through percolation and seepage (Efficiency in use).
- To apply sufficient quantity to field crops (Optimization of use).
- To utilize the water considering cost-benefit (Economically viable management).
- To distribute the available water without any social problem (Judicial distribution).
- To meet the future requirement of agricultural and other sections (Resource conservation).
- To protect the environment from over use or misuse of water (Environment safe use).

(d) *Impact of excess and insufficient irrigation water in crops* - Avoid excess or insufficient water to the crops. Excess irrigation leads to wastage of large amount of water, leaching of plant nutrients, destruction of beneficial microbes, increase of expenses on drainage, accumulation of salt leading to salinity and alkalinity, water-logging leading to physiological stress and yield loss or crop failure.

Insufficient irrigation leads to reduction in quality of food grains, loss in crop yield or crop failure, poor soil environment etc.

Water becomes a limiting resource due to the multi-various demand from sectors like agriculture, livestock, industries, power generation and increased urban and rural domestic use. The increasing population increases the needs of industrial complexes and urbanization to meet the basic requirement and also to provide employment opportunities. So the demand for water is increasing day by day and hence, it is essential to study water potential and its contribution to agriculture, which in turn is going to feed the growing population.

11.2 SOURCES OF WATER

Rainfall is the ultimate source of all kind of water. Based on its sources of availability, it can be classified as surface water and subsurface water.

11.2.1 Surface Water

It includes (including rainfall and dew) water available from river, tank, pond, lake etc. Besides, snowfall could able to contribute some quantity of water in heavy snowfall areas like Jammu, Kashmir and Himalaya region.

A. Rainfall

(a) Characteristics

- Quantity should be sufficient to replace the moisture depleted from the root zone.
- Frequency should be so as to maintain the crop without any water stress before it starts to wilt.
- Intensity should be low enough to suit the soil absorption capacity.

Indian rainfall does not have the above good characteristics to maintain the crop through rainfall alone. The following are the characteristic features of Indian rainfall.

- Annual average rainfall is 1190 mm.
- There is wide variation in the quantity of rainfall received from place to place. Highly erratic, undependable, variation in seasonal rainfall either in excess or deficit is the nature of Indian rainfall. For example a place in Rajasthan receives practically nil rainfall at the same time Chirapunji about 3000 mm rainfall.
- Rainfall is not uniformly distributed throughout the year. It is seasonal, major quantity is in the South West Monsoon, (SWM alone contributing 70% of total rainfall) *i.e.*, in the month of June to September followed by North-East Monsoon (NEM) from October to December. In summer and winter the amount of rainfall is very little.
- Within the season also the distribution is not uniform. A sudden heavy downpour followed by dry spell for a long period is common occurrence.
- Rainfall distribution over a large number of days is more effective than heavy down pour in a short period, but it is in negative trend in India.
- Late commencement of monsoon.
- Early withdrawal of monsoon and liability to failure are the freakish behaviour of Indian rainfall. Timely and uniform distribution of rainfall is important for better crop planning and to sustain crop production.

(b) Seasons

The seasons of rainfall are discussed in detail in chapter IV.

11.2.2 Sub Surface Water

It includes subsurface water contribution, underground water, well water, etc.

11.3 HISTORY AND STATISTICS

Irrigation has been practiced since time immemorial, nobody knows when it was started but evidences say that it is the foundation for all civilization since great civilization were started in the river basins of Sind and Nile. This civilization came to an end when the irrigation system failed to maintain crop production. There are some evidences that during the Vedic period (400 B.C.) people used to irrigate their crops with dug well water. Irrigation was gradually developed and extended during the Hindus, Muslims and British periods.

The Grand Anaicut (KALLANAI) constructed across the river Cauvery is an outstanding example for the irrigation work by a Chola king the great Karikala Cholan during second century. The Veerananayagan Tank and Gangai Konda Cholapuram tank was constructed during 10th century in Tamil Nadu. Anantaraja Sagar in Andhra Pradesh was constructed during 13th century. Early Mauryan king Samudragupta and Ashoka took great interest in the construction of wells and tanks. Later Moghul kings or North India and Hindu kings of South India focused their attention, in the establishment of canals, dams, tanks etc. British Government initiated their work during 19th century in remodeling and renovation of the existing irrigation system. The Upper Ganga canal, Krishna and Godavari delta system, Mettur and Periyar dams are the great irrigation structures built by the British rulers. After independence, Irrigation activities have been accelerated and number of multipurpose river valley projects like Bhakra-nangal in Punjab, Tungabhadra in Andhra Pradesh, Damodar Valley in Madhya Pradesh were established.

A. Irrigation Development During Five Year Plans

In 1950-51, the gross irrigated area was 22.5 m.ha. After completion of 1st five-year plan, the gross irrigated area was enlarged to 26.2 m.ha. Further, it was gradually increased to 29, 35.5, 44.2, 53.5 and 55 m.ha respectively over the II, III, IV, V, VI and VII five years plans. The expected increase through VIII and IX five year plans area 95 and 105 m.ha. respectively.

B. Classification of Irrigation Work or Projects

The irrigation projects can be classified as: (1) major, (2) medium (3) minor based on financial limits or expenditure involved in the scheme.

Major—More than Rs. 50 million - It covers cultural command area of more than 10,000 ha.

Medium—Rs. 2.5-50 million - It covers cultural command area of 2000–10,000 ha.

Minor—less than Rs. 2.5 million - It covers cultural command area of 2,000 hectares.

The minor irrigation work consists of irrigation tanks, canals and diversion work for the welfare of small farmers.

India has many perennial and seasonal rivers, which flow from outside and within the country. Among this, some important rivers of different states are given below.

C. Important Irrigation Projects in India

<i>State</i>	<i>Project name</i>
Andhra Pradesh	Godavari delta system, Krishna delta system, Nagarjuna sagar (Krishna)
Bihar	Gandaka
Punjab	Western Jamuna, Bhakranagal, Sutlej, Beas
Gujarat	Kakrapare–Tapti Narmada
Madhya Pradesh	Gandhi sagar (Chambal, Ranap setab, Sagar)
Maharashtra	Bhima Jayakwadi (Godavari)
Kerala	Kalada, Mullai Periyar
Karnataka	Ghataprabha, Malaprapha and Turga
Orissa	Hirkund and Mahanadi
Uttar Pradesh	Upper ganga canal, Ramaganga
West Bengal	Damodar Valley
Rajasthan	Rajasthan Canal (Sutlej)
Tamil Nadu	Mettur–Lower Bhavani Project Parambikulam Alliyar Project Periyar Vaigai, Cauvery delta Tamirabarani river basins

D. India's Water Budget

Total geographical area	= 328 m.ha.
Average annual rainfall	= 1190 mm
In m.ha metre	= $1190 \times 328 = 392$ m.ha.m
Contribution from snowfall	= 8 m.ha.m.
Total	= 400 m.ha.m.

The rainfall below 2.5 mm is not considered for water budgeting, since it will immediately evaporate from surface soil without any contribution to surface water or ground water. When rainfall occurs, a portion of it immediately evaporates from the ground or transpires from vegetation, a portion infiltrates into the soil and the rest flows over surface as run off. There are on an average 130 rainy days in a year in the country out of which the rain during 75 rainy days considered as effective rain. The remaining 55 rainy days are very light and shallow which evaporates immediately without any contribution to surface or ground water recharge. Considering all these factors it is estimated that out of 400 m.ha. meter of annual rainfall 70 m.ha. meter is lost to atmosphere through evaporation and transpiration, about 115 m.ha. meter flows as surface run-off and remaining 215 m.ha. meter soaks or infiltrates into the soil profile.

E. Surface run-off

Surface run off consists of direct run off from rainfall, melting of snowfall and flow in streams generated from ground water. Total surface run-off has been estimated by Irrigation Commission of India in 1972 as follows:

Total surface run off	180 m.ha.m
-----------------------	------------

Rain fall contribution	115 m.ha.m
Contribution from outside the country through streams and rivers	20 m.ha.m
Contribution from regeneration from ground water in Stream and rivers	45 m.ha.m

Disposal of surface run off - The surface runoff is disposed in three ways viz., (a) stored in reservoirs, (b) disappears by means of percolation, seepage and evaporation, and (c) goes to sea as waste. The water stored in reservoirs is lost through evaporation and some amount through seepage. The rest is utilized for various purposes mainly for irrigation and drinking water.

Total surface run off	= 180 m.ha.m
Stored in reservoir and tanks	= 15 m.ha.m
Flow in the river	= 165 m.ha.m
Utilization from the river by diversion tank and direct pumping	= 15 m.ha.m
Water goes to sea as waste	= 150 m.ha.m
On full development work expected utilization	= 45 m.ha.m
Water flows to sea	= 105 m.ha.m

F. Land Utilization Pattern of India

Total geographical area	= 328.00 m.ha.
Net area reported	= 307.47 m.ha.
Area under forest	= 65.90 m.ha.
Area under non-agricultural use, barren and uncultivable waste	= 100.45 m.ha.
Net area sown	= 141.12 m.ha.
Net area irrigated	= 31.20 m.ha.
Gross area sown	= 164.00 m.ha.
Gross area irrigated	= 80.50 m.ha.

G. Land Utilization Pattern in Tamil Nadu

Total geographical area	= 13.00 m.ha.
Area under forest	= 2.00 m.ha.
Non agricultural area	= 1.40 m.ha.
Barren and uncultivated	= 0.80 m.ha.
Pastures	= 0.20 m.ha.
Tree	= 0.20 m.ha.
Culturable waste	= 0.50 m.ha.
Culturable fallow	= 0.90 m.ha.
Other fallow	= 0.50 m.ha.
Gross area under cultivation	= 7.30 m.ha.
Net area sown	= 6.30 m.ha.
Gross area irrigated	= 3.50 m.ha.
Net area irrigated	= 2.70 m.ha.

H. % Area depends upon Groundwater in various Parts of Tamil Nadu

Salem	= 83%
Dharmapuri	= 65.3%
Coimbatore	= 51.3%
Madurai	= 45.1%
Trichy	= 34.9%
Tirunelveli	= 35.0%

J. Water Resources in India and Tamil Nadu**Table 11.1.** Distribution of Irrigated Area in '000 hectares

	<i>Canal</i>	<i>Tanks</i>	<i>Wells</i>	<i>Other</i>
India	12,776	4,123	12,034	2,601
Tamil Nadu	931	924	820	35

Table 11.2. World Irrigation Statistics

<i>Sl.No.</i>	<i>Countries</i>	<i>Area irrigated (m.ha.)</i>
1.	Australia	1.150
2.	Botswana	0.002
3.	Brazil	0.141
4.	Burma	0.753
5.	Canada	0.627
6.	Ethiopia	0.030
7.	France	2.600
8.	India	37.640
9.	Indonesia	3.797
10.	Iran	4.000
11.	Iraq	3.107
12.	Israel	0.153
13.	Japan	3.390
14.	Pakistan	11.970
15.	Former USSR	9.900
16.	USA	16.932
17.	China	74.000

The ultimate irrigation potential of our country is 155 m.ha. out of 165 m.ha. of total cultivable area. So far the achievement has been made through more than 215 major irrigation projects, 900 medium irrigation projects and many number of minor irrigation projects which consume a yearly outlay of Rs. 25,000–Rs. 35,000 crores in the National budget. After the completion of VI five-year plan we could achieve irrigation potential at the rate of 2.2 m.ha. per annum. Now the rate of increase in irrigation potential is 13 m.ha. per year. Even though the irrigation potential has been increased, the gap between irrigation potential created and utilized is very wide. Hence, we are at the critical stage to narrow down this gap between created and utilized irrigation potential. More than 80 per cent area can

be brought under irrigation if the resources (which include surface and groundwater) are efficiently utilized mainly through scientifically improved irrigation scheduling. Tremendous national and international scientific efforts have been made on the problem of irrigation scheduling, but achievement has not yet been fulfilled. This is a challenging task to our Scientist, Engineers, Planners, Policy-makers and to the Farm managers.

11.4 CROP WATER REQUIREMENT

Water requirement is defined as the quantity of water required by a crop or a diversified pattern of crops in a given period of time for its normal growth at a place under field conditions. The source of water may be anything like wells, tanks, artisan wells of canals of rivers.

Water requirement - Crop water requirement is the water required by the plants for its survival, growth, development and to produce economic parts. This requirement is applied either naturally by precipitation or artificially by irrigation. Hence the crop water requirement includes all losses like:

- Transpiration loss through leaves (T).
- Evaporation loss through soil surface in cropped area (E).
- Amount of water used by plants (WP) for its metabolic activities, which is, estimated as less than 1% of the total water absorption. These three components cannot be separated so easily. Hence, the ET loss is taken as crop water use or crop water consumptive use.
- Other application losses are conveyance loss, percolation loss, runoff loss etc., (WL).
- The water required for special purpose (WSP) like puddling operation, ploughing operation, land preparation, leaching requirement, for the purpose of weeding for dissolving fertilizers and chemicals etc.

Hence, the water requirement is symbolically represented as:

$$WR = T + E + WP + WL + WSP$$

The other application losses and special purposes are mostly indented for wetland cultivation. Hence, for garden land crop, the ET loss alone is accounted for crop water requirement. The estimation of the water requirement of crop is one of the basic needs for crop planning in the farm and for the planning of any irrigation project. Water requirement includes the losses due to ET or CU and losses during the application of irrigation water and the quantity of water required for special purposes or operations such as land preparation, transplanting, leaching etc. Hence, it may be formulated as follows for demand point of view as;

$$WR = ET \text{ or } Cu + \text{application loss} + \text{water for special needs.}$$

It can also be stated based on supply source as follows:

$$WR = IR + ER + S$$

Where,

IR	-	Irrigation requirement
ER	-	Effective rainfall
S	-	Contribution from groundwater table.

Hence, the idea about crop water requirement is essential for farm planning with respect to total quantity of water needed and its efficient use of various cropping schemes of the farm or project area. This crop water requirement is also needed to decide the stream size and design the canal capacity. The combined loss of evaporation and transpiration from a cropped field is termed as evapotranspiration

which is otherwise known as consumptive use and denoted as ET and this is a part of water requirement.

$$CU = E + T + WP$$

Therefore,

$$WR = CU + WL + WSP$$

The crop water requirement can also be defined as water required to meet the evapotranspiration demand of the crop and special needs in case of wet land crop and which also includes other application losses both in the case of wet land and garden land crops. This is also known as crop water demand.

11.4.1 Evaporation

Evaporation is defined as the process by which water moves out of the water surface or soil surface in the form of water vapour to atmosphere due to pressure gradient. Evaporation from natural surface such as open water, bare soil or vegetative cover is a diffusive process by which water in the form of vapour is transferred from the underlying surface to the atmosphere. The essential requirement for evaporation process are:

- Source of heat energy to vaporize the irrigated water.
- The presence of a concentration gradient of water vapour between the evaporating surface and surrounding air of atmosphere.

Evaporation can occur only when vapour concentration of evaporating surface exceeds that of the surrounding air. The sources of heat energy are solar energy and wind energy. The energy required for evaporation is 590 calories per gram of water to evaporate at 20°C. The fundamental principle of evaporation from a free surface has indicated evaporation as the function of difference in the vapour pressure of water surface and the vapour pressure of air.

Measurement of evaporation - This can be made by the following methods.

- Pan evaporimeter
- Tin can evaporimeter
- Pitche evaporimeter

1. **Pan Evaporimeter**- Evaporimeter is an instrument which integrates the effect of all the different climatic elements and furnishes their combined effect. It is relatively simple, cheap and more useful in irrigation practices.
2. **“U.S.W.B. Class A pan” Evaporimeter** - It is the standard type used globally. It is made of GI pan having a diameter of 120 cm with a depth of 25 cm. It is painted with white colour to reduce heat absorption and mounted on a wooden platform at a height of 15 cm from ground level to reduce the effect of soil temperature. The water level is measured by the Hook gauge or a fixed scale attached to a stilling well. The pan is covered with a mesh to prevent animals' and bird's disturbances to the water. Evaporation is recorded at a fixed time in the still well by adding water in the evaporimeter to compensate the daily loss of water by evaporation. Evaporimeter is to be cleaned periodically and tested for its leakage. Development of algae etc., should be avoided.
3. **“Tin can” evaporimeter** - A small tin is fitted with a scale and water is filled in the tin and kept in the cropped field at different locations. The daily loss will be taken as evaporation.
4. **“Pitche” evaporimeter** - It consists of a graduated tube of 30 cm with one open end and covered by a drier paper and is attached in a metallic stand. The tube is filled with water and turned upside down. The water slowly wets the paper and evaporates and the water loss in the tube is considered as a measurement of evaporation. Evaporation, transpiration and consumptive use are the important factors in estimating irrigation requirement and planning irrigation system.

11.4.2 Transpiration

This is the process by which water in plant body transfers to the atmosphere in the form of water vapour. Transpiration is the process by which water evaporates in the form of water vapour from living plant body especially from leaves to atmosphere. It involves a continuous movement of water from soil to atmosphere through root, stem and leaves. The rate of transpiration depends on:

- Supply of energy to vapourise the water, and
- The water vapour concentration gradient at atmosphere.

It is further influenced by the climatic, soil and plant factors.

Climatic factors - Light intensity, temperature and wind.

Soil factors - Texture, infiltration rate, water holding capacity, field capacity, moisture-releasing pattern etc.

Plant factors - Root system, leaf area, leaf arrangements, leaf structure, stomatal behaviour, etc.

11.4.3 Evapotranspiration or Consumptive Use

It is very difficult to separate the losses due to evaporation and transpiration in a cropped field. Hence, these two processes are combined to a term called Evapo-Transpiration (ET). These two losses are considered as water used for plant growth and hence it can be considered as Consumptive Use (CU). The consumptive use includes all water consumed by the plants and the water evaporated from bare land and water surface in the area occupied by the crop plants.

Factors affecting ET

- Solar radiation which supplies energy for ET.
- Wind, which removes the water vapour from cropped area and makes changes in water vapour concentration gradient.
- Temperature which increases ET rate.
- Relative humidity which changes the ET rate due to changes in water vapour gradient. All the above are interrelated with each other.
- Stage of the crop.

It has a considerable influence on ET rate. This is very particular in annual crops which has a distinctive stage of growth. These are:

- **Emergence and development** - ET or Consumptive use rate increase rapidly from low value and approaches its maximum.
- **Maximum Vegetative phase** - ET or CU rate is maximum if abundant soil moisture is available.
- **Maturity phase** - ET or CU rate begins to decrease.
- Rooting characters of crop plants.
- Environment.

If the surrounding lands are barren, ET or CU will be more than the cropped area, which is covered with vegetation. Evapotranspiration or Consumptive use is the important phenomena in irrigation management since, it denotes the quantity of water transpired by plants during their growth or retained in the plant and the moisture vaporized from the surface of the soil under vegetation.

11.4.4 Potential Evapotranspiration (PET)

It is the evapotranspiration from a large area fully covered with short vegetation with sufficient available

water. Or it can also be stated that ET from the fully covered vegetative area under unlimited water available at all the times. This concept was suggested by Thornthwait in 1948. Further, Jensen in 1968 assumed that PET is the upper limit of ET that would occur with a well-irrigated, well-grown agricultural crop, it is also known as reference evapotranspiration and denoted as ET_0 . It can be calculated by four empirical methods using different climatic components suggested by irrigation scientists. They are: (1) Blaney and Criddle, (2) Radiation method, (3) Pan evaporation method, (4) Modified pennman method. The reference crop evaporation (ET_0) can be obtained from

$$ET_0 = K_p \times E_{pan}$$

Where,

K_p = Pan coefficient

E_{pan} = Mean evaporation in mm/day

The K_p values for different agro climatic conditions have been already standardized (Refer-Table 18. From FAO Irrigation and Drainage paper 24). For our condition, 0.8 can be taken as K_p value.

(a) **Selection of crop coefficient for estimating ET** - The value of ET need to be adjusted for actual crop ET, since under natural field condition PET rarely occurs in most of the irrigated field crops. Normally the PET will occur in low land rice and two to three days after irrigation or rain in garden land condition. For converting ET_0 value into ET crop, suitable crop coefficients (denoted as K_c) should be evolved for different crops, soil, climate and different stages of crops. Crop coefficient is the ratio between ET crop and ET_0 .

$$ET \text{ crop} = K_c \times E_{t0}$$

$$K_c = \frac{ET \text{ crop}}{ET_0}$$

This ratio is usually 0.2 during early growth stage and about 1.0 when the crop develops maximum canopy and root system. The ratio again gets reduced as the crop approaches maturity. Value of crop factors have to be worked out for local situation.

(b) **Seasonal consumptive use** - It is the total water requirement for the crop growing periods to meet the ET loss. Hence, it can be stated as the total water used in evapotranspiration by cropped area during the entire growing season, which is called as seasonal consumptive use. It is expressed as depth of water in cm. This value is used to evaluate and determine the seasonal irrigation water requirement. Seasonal consumptive use values are required to evaluate and determine the seasonal irrigation water supplies.

(c) **Peak period consumptive use** - The highest consumptive use for certain period in the growth season is called the peak period consumptive use. This value is used in the planning and designing of irrigation system. The peak period consumptive use will vary from soil to soil and from crop to crop. In the irrigation project designs, this peak period CU will be accounted for proper planning and use of the available water effectively for different cropping pattern. This peak use rate also varies in different climatic conditions. The Table 11.3 given below indicates the peak rate of soil moisture removed by crops under different climatic conditions.

(d) **Measurement of evapotranspiration** - The methods adopted to measure the evapotranspiration or actual consumptive use are:

- Lysimeter experiment
- Filed Experimental plot method

Table 11.3. Maximum rates of Soil Moisture used by Crops under different Climatic Condition

<i>Climate</i>	<i>Peak rate of soil moisture removed (mm/day)</i>
Cool humid	3
Cool dry	4
Moderate humid	4
Moderate dry	5
Hot humid	5
Hot dry	8

- Soil moisture depletion studies
- Water balance method.

1. **Lysimeter experiment** - It is otherwise known as evapotranspiration meter. It is nothing but growing the crop in big containers (filled with soil) under natural conditions of the field to determine the water gain and loss to work out the evaporation and transpiration. In this method, ET is measured directly to study the climatic factors.

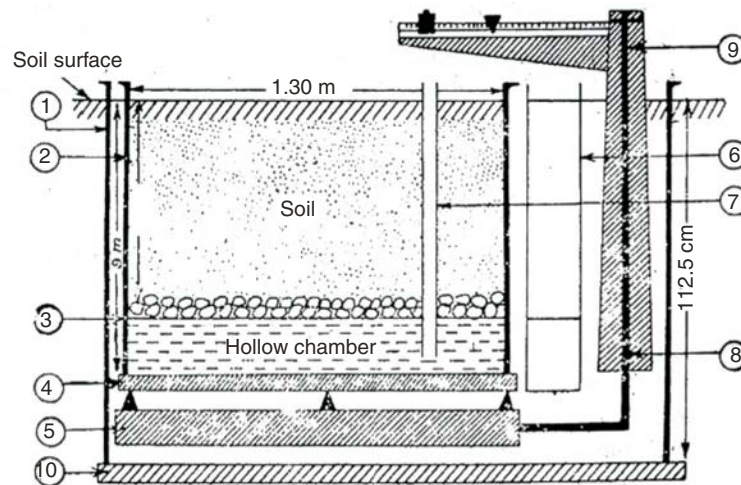
**Fig. 11.1** Schematic diagram of mechanical weighing lysimeter

1. Retaining tank, 2. Lysimeter tank, 3. Perforated plate, 4. Platform, 5, 8, 9 - Balance, 6. Dummy tank, 7. Pipe to remove percolated water, 10. Foundation)

Important precautions - The soil condition inside the lysimeter must be similar to that of the outside field. The lysimeter must be surrounded by the same crop that is growing inside the lysimeter. The lysimeter should not be surrounded by sidewalls, path or gravel which will affect the reliability of data. The rim or border of the lysimeter should be as small as possible to reduce the difference in soil temperature in the lysimeter wall as in the fields. There are two types of lysimeter.

Weighing type - Here, the added water and water losses are weighed through the weighing balance fitted in the lysimeter. The weight difference is taken into account to measure the ET.

Non-weighing type - Here, the changes in the soil moisture at time intervals is measured by using neutron probe to work out the ET. In both the cases different sizes of lysimeter are available.

Disadvantages - Reproduction of same physical condition as that of the field such as temperature, water table, soil texture, densities etc., within the lysimeter are very difficult.

2. **Field experimental plot method** - In this method, seasonal water requirements are computed by adding measured quantities of irrigation water, the effective rainfall received during the season and the contribution of moisture from the soil.

$$WR = IR + ER + \sum_{i=1}^n \left[\frac{M_{bi} - M_{ei}}{A_i D_i} \right]_{100}$$

Where,

- | | | |
|-----------------|---|---|
| WR | - | Water requirement in mm. |
| IR | - | Total irrigation water applied in mm. |
| ER | - | Seasonal effective rainfall contribution in mm. |
| M _{bi} | - | Moisture content at the beginning of the season in the i th layer of soil. |
| M _{ei} | - | Moisture content at the end of the season at i th layer of soil. |
| A _i | - | Apparent specific gravity of the soil at i th layer. |
| D _i | - | Depth of soil at i th layer unit. |
| n | - | Number of layers in the soil. |
3. **Soil moisture depletion studies** - This method is applicable to the irrigated field crops in fairly uniform soil when the depth to the ground water is such that it will not influence the soil moisture fluctuation within the root zone. These studies involve measurements of soil moisture from various depths at a number of times throughout the growth period. Consumptive use (Cu) is calculated from the change in soil water content in successive samples from the following relationship.

$$Cu = \sum_{i=1}^n \left[\frac{M_{bi} - M_{ei}}{100} \right] A_i D_i$$

Where,

- | | | |
|-----------------|---|---|
| CU | - | Consumptive use in mm. |
| M _{bi} | - | Moisture content at the beginning of the season in the i th layer of soil. |
| M _{ei} | - | Moisture content at the end of the season at i th layer of soil. |
| A _i | - | Apparent specific gravity of the soil at i th layer. |
| D _i | - | Depth of soil at i th layer unit. |
| n | - | Number of layers in the soil. |
- Disadvantages** - It does not provide information on intermediate soil moisture condition, short term use, deep percolation losses and peak use rate of the crop.

4. **Water balance method** - This is done at macro level. This is also called as the inflow-outflow method, which is suitable for larger areas (watersheds) over longer periods. Knowledge of the water balance is necessary to evaluate the possible methods to minimize loss and to maximize the gains and utilization of water, which is the limiting factor for crop production. The water balance of a field is comprehensive statement of all gains and losses of a given field within specified period of time. The task of monitoring and controlling of field water balance is important to the efficient management of water and soil. A gain of water in the field is generally due

to precipitation and irrigation and occasionally due to run off collection from higher tracts and from shallow ground water table.

Losses of water includes: (a) surface run off, (b) transpiration from foliage, (c) evaporation from soil surface, (d) deep percolation out of the root zone etc. The change in storage of water in the field can occur in the soil as well as in the plants. The total change in storage must be equal to the difference between the sum of all gains and sum of all losses and is represented by the hydrological equation.

$$\text{Change in storage} = \text{Gain} - \text{loss} \\ (P + I + \text{GW}) - (ET + R + D)$$

Where,

P	=	Precipitation
I	=	Irrigation
GW	=	Ground water contribution
ET	=	Evapotranspiration
R	=	Ruff off loss
D	=	Deep percolation loss

$$P = ET + O + D + \Delta W$$

Where,

P	=	Précipitation
ET	=	Evapotranspiration
O	=	Surface runoff
D	=	Subsurface drainage
ΔW	=	Changes in soil water content

(e) **Factors affecting water requirement** - The crop water requirement varies from place to place, from crop to crop and depends on agro-ecological variation and crop characters. The following features which mainly influence the crop water requirement are:

Crop factors - Variety, growth stages, duration, plant population and crop growing season.

Soil factors - Structure, texture, depth, topography and soil chemical composition.

Climatic factors - Temperature, sunshine hours, relative humidity, wind velocity and rainfall.

Agronomic management factors - Irrigation methods used, frequency of irrigation and its efficiency and tillage and other cultural operations like weeding, mulching etc.

Based on all these factors, average crop water requirement for various crops have been worked out and given below for tropical conditions. In general, this crop water requirement can be classified as:

Low ranging from 300-450 mm green gram, black gram, sunflower, safflower, finger millet and minor millets.

Medium ranging from 450-650 mm maize, sorghum, wheat, groundnut and sunflower.

High ranging from 600-1000 mm cotton and perennial red gram.

Very High ranging from 1000-2250 mm rice, sugarcane, banana and plantation crops.

(f) WR range for different crops

<i>Crop</i>	<i>WR (mm)</i>
Rice	1200–1400
Maize	400–550
Sorghum	400–550
Wheat	450–550
Ragi	350–550
Pulses	350–450
Groundnut	350–650
Sunflower	300–500
Cotton	600–850
Sugarcane	1400–2000
Banana	1650–2250
Plantation crop	1250–1850

11.5 IRRIGATION REQUIREMENT

The field irrigation requirement of crops refers to water requirement of crops exclusive of effective rainfall and contribution from soil profile and it may be given as follows.

$$IR = WR - (ER + S)$$

Where,

IR	=	irrigation requirement
WR	=	water requirement
ER	=	effective rainfall
S	=	soil moisture contribution

Irrigation requirement depends upon the (a) irrigation need of individual crop, (b) Area of crop, and (c) losses in the farm water distribution system etc. All the quantities are usually expressed in terms of water per unit of land area (cm/ha) or unit of depth (cm or mm).

A. Net Irrigation Requirement

It is the actual quantity of water required in terms of depth to bring the soil moisture to field capacity level to meet the ET demand of the crops. It is the water applied by irrigation in terms of depths to bring the field-to-field capacity level. To work out the net irrigation requirement, ground water contribution and other gains in soil moisture are to be excluded. It is the amount of irrigation water required to bring the soil moisture level in the effective root zone to field capacity, which in turn meet the ET demand of the crop. It is the difference between the F.C. and the soil moisture content in the root zone before starting irrigation.

$$d = \sum_{i=1}^n \left| \frac{M_{fci} - M_{bi}}{100} \right| A_i D_i$$

Where,

d	–	Net irrigation water to be applied (cm)
M_{fci}	–	Moisture content at FC in i^{th} layer (%)
M_{bi}	–	Moisture content before irrigation in i^{th} layer (%)
A_i	–	Bulk density (g/cc) at i^{th} layer
D_i	–	depth (cm) of i^{th} soil layer
n	–	number of soil layers.

B. Gross Irrigation Requirement

The total quantity of water used for irrigation is termed as gross irrigation requirement. It includes net irrigation requirement and losses in water application and other losses. The gross irrigation requirement can be determined for a field, for a farm, for an outlet command area and for an irrigation project, depending on the need by considering the approximate losses at various stages of crop.

$$\text{Gross irrigation requirement} = \frac{\text{Net irrigation requirement}}{\text{Field efficiency of system}} \times 100$$

C. Irrigation Frequency

Irrigation frequency is the interval between two consecutive irrigations during crop periods. Irrigation frequency is the number of days between irrigations during crop periods without rainfall. It depends upon the rate of uptake of water by plants and soil moisture supply capacity to plant and soil moisture available in the root zone. Hence, it is a function of crop, soil and climate. Normally irrigation should be given at about 50 per cent and not over 60 per cent depletion of the available moisture from the effective root zone in which most of the roots are concentrated. In designing irrigation system, the irrigation frequency to be used is the time (days) between two irrigations in the period of highest consumptive use of crop growth, *i.e.*, peak consumptive use of crop.

Design frequency (days)

$$= \frac{\text{FC} - \text{moisture content of the root zone prior to starting irrigation}}{\text{Peak period consumptive use rate of crop}}$$

Irrigation period - Irrigation period is the number of days that can be allowed for applying one irrigation to a given design area during peak consumptive use period of the crop.

$$\text{Irrigation period} = \frac{\text{Net amount of moisture in soil at start of irrigation (FC-PWP)}}{\text{Peak period consumptive use of the crop}}$$

Growth duration - Growth duration of different crops varies considerably. The growth duration of the irrigated dry crops (ID crops) like sorghum, maize, groundnut, pulses etc. is restricted to a single crop season and known as seasonal crops. The growth span of crops like cotton, red gram, chillies, etc. is spread over to two seasons and are known as biseasonal or two seasonal crops. Crops like sugarcane, and banana take more than a year and are referred as annual or biennial crops and plantation crops like coconut, tea, coffee etc., which take one to several years for their growth are referred to as perennial crops. The growth period of ID crops are broadly divided into three phases namely:

Vegetative phase

- (a) Crop establishment (first two or three weeks)
- (b) Crop development (two to six weeks)

Reproductive phase

- (a) Flowering stage
- (b) Fruiting stage

Maturity phase

- (a) Enlargement
- (b) Ripening
- (c) Harvest

The entire reproductive and flowering phase in most ID crops are highly sensitive growth periods. In this period, water stress or excess water condition should be avoided.

Growth stages of cereals in relation to irrigation

<i>Stage</i>		<i>Details</i>
Germination	–	the appearance of radicle
Filleting	–	the formation of tillers
Jointing	–	the stage when two nodes be seen <i>i.e.</i> , beginning of shooting
Shooting	–	the stage of elongation of internodes
Booting	–	end of shooting stage and just prior to the emergence of ears
Heading	–	emergence of ear head from the tube formed by the leaf sheath
Flowering	–	the opening of flowers
Grain formation	–	the period of grain development from fertilization to maturity.
Further divided into		
Milk stage	–	Milky consistency
Dough stage	–	Doughy consistency
Dead ripe	–	Ripe for harvesting

11.6 EFFECTIVE RAINFALL

ER means useful or utilizable rainfall. All the rainfall received are not used by the crops because of its erratic nature such as untimeliness, lesser or higher quantity etc. The useful portions of rainfall which is stored in soil and supplied to the crop for its consumptive use is called effective rainfall. The term effective rainfall has been interpreted differently by different specialists. To a canal engineer, the rain which reaches the storage reservoir is the effective portion. To a hydro electrical engineer, the rainfall which is useful for running the turbines that generate electricity is effective. To an agriculturist, the portion of total rainfall that directly satisfies crop water needs and also the surface run off which can be stored and used for crop production is considered as effective rainfall. The rainwater which moves out of the field by surface runoff and deep percolation beyond the root zone of the crop are ineffective rainfall.

A. Factors influencing ER

Several factors influence the proportion of effective rainfall and these may act singly or collectively and interact with each other.

Rainfall characteristics - Large quantity as well as high intensity will reduce effectiveness because of excess run off and less infiltration rate. A well-distributed rainfall with some frequent light showers is more conducive to crop growth than downpour.

Land slope - Here, because of the slope very less infiltration opportunity time is available which results in rapid run off loss and less effective.

Soil properties - Properties like infiltration rate, retention capacity, releasing capability and movement of water influence the degree of effectiveness. High infiltration, high water holding capacity etc., increase effectiveness by avoiding run of losses. High moisture content, low infiltration rate, low water holding capacity reduces effectiveness.

Ground water characteristics - Shallow water table causes more run off and effectiveness is low. Deep water table causes more infiltration and percolation and effectiveness of rainfall is more.

Management practices - Bunding, terracing, contour tillage, ridging, mulching, etc., reduce the run off and increases the effectiveness of rainfall.

Crop characteristics - Crop with high water consumption creates greater deficits of moisture in the soil. The effective rainfall is directly proportional to the rate of water uptake by the plant.

Carry over soil moisture - It is the moisture stored in the crop root zone depth between cropping seasons or before the crop is planted. This moisture is available to meet the consumptive water needs of the succeeding crop. The contribution of rain occurring just prior to sowing may be equivalent to one full irrigation.

Seepage and percolation - Surface and sub surface seepage and deep percolation below root zone will also influence effectiveness of rainfall. In drawing the seasonal or monthly irrigation requirement for a given crop or cropping pattern, the main variables composing the field water balance include.

- Crop water requirement as determined by dominant crop characteristics.
- Contribution from precipitation, ground water and carry over soil moisture.

11.7 METHODS OF IRRIGATION

Application of irrigation water to cropped field by different types of layouts are called as irrigation methods. The methods of irrigation initially might have been started to check the over flow of water from one field to another. But today, it has become necessary to save the water by proper methods to arrest run-off loss, percolation loss, evaporation loss etc., and to optimize the crop water need. Hence, irrigation method can be defined as the way in which the water is applied to the cropped field without much application and other losses, with an objective of applying water effectively to facilitate better environment for crop growth.

11.7.1 Factors Influencing Irrigation Methods

Soil type - The soil physical properties such as texture, structure, porosity, infiltration rate, etc. influence the selection of irrigation methods. Heavy texture soil restricts water movement than light texture soil wherein water move freely to deeper sections due to high porosity. Single grain structure soil allows water freely to move downward compared to other structures

Soil depth - If soil is shallow which holds less water, leveling and forming bunds etc. to hold maximum water to increase the irrigation interval. Similarly if the soil is deep, it holds more water and needs longer irrigation interval. Accordingly, the irrigation methods can be selected.

Topography of land - In undulating topography, it is very difficult to adopt normal methods of irrigation. The slope of the land also decides the methods to be adopted. If the land is more sloppy, basin

method cannot be used. In this condition strip method can be used. For undulating topography instead of strip or basin method, sprinkler or drip methods can be used.

Climate - Rainfall, temperature, humidity, wind velocity, radiation, etc., influence the irrigation methods. For example, heavy wind affects sprinkler irrigation and temperature affects surface method of irrigation by high evaporation loss.

Water sources - The flow velocity, quantity and quality of available water are the other main factors, which decide the methods of irrigation to be adopted.

Crops to be grown - The value of the plant and geometry of the crop to be cultivated are the main criteria to decide the method of irrigation. For example, if the crop is a high value or cash crop or wide spaced crop, sprinkler or drip method of irrigation can be adopted. Irrigation water can be applied to the land in the following general ways.

By flooding (wetting all the land surface)

By furrows (wetting only a part of the ground surface in which crops are grown)

By sub irrigation (sub surface soil irrigation)

By sprinkler (soil is wetted through sprinkling water)

By drip irrigation (water is applied at the individual root zone of the plant).

11.7.2 Classification of Irrigation Methods

The irrigation methods are broadly classified as:

- Surface method or gravity method of irrigation
- Sub surface or sub irrigation
- Pressurized or micro irrigation - Drip irrigation, sprinkler irrigation and rain gun irrigation.

I. Surface or gravity irrigation

It is the common method of irrigation practiced all over the world. In this method, water is applied directly to the surface by providing some checks to the water flow:

Advantages

- Easy to maintain
- Low cost
- Technical skill is not required.

Prerequisites

- Uniform soil
- Smoothness of field surface or levelled surface
- Adequate quantity of water.

Classification

1. **Border strip method** - The field is divided into number of long parallel strips by providing small parallel earthen bunds or levees or dykes along both sides of the strips. The end along the strip may or may not be closed, which is based on the length of the strips. If the length of the strip is very long, the end will be closed to have a uniform distribution and to avoid run off loss. Each strip is irrigated independently from upper end (turned on) and water flow as thin sheet and uniformly spread along the strips. The water is turned off when the required volume is delivered to the strip. The application efficiency of this system is 75–85%.

(a) Suitability

Soil - Suitable to the soils having

- Moderately low to moderately high infiltration rate.
- To the field which is having 0-0.5% slope.
- For dense, closer spaced crop it can be advocated up to 4% slope provided there should not be any erosion hazard.
- Not suited for very sandy soil and very clayey soil as they have too high and low infiltration rate, respectively.

Crop - All closely spaced crops like pulses, wheat, barley, alfalfa, berseem, grasses, ragi, cumbu and small grains.

(b) Dimensions

The width of the strips depend upon the size of the stream and normally this varies from 3–15 m. The length varies according to the slope, stream size, soil type, etc. Length of the border strips and recommended safe limits of slopes for various types of soil are given below.

	<i>Length</i>	<i>Slope (%)</i>
Sandy and sandy loam soil	6.0–12.0 m	0.25 to 0.60
Medium loam soil	10.0–18.0 m	0.20 to 0.40
Clay loam to clay soil	15.0–30.0 m	0.05 to 0.20

(c) Classification- It can be further classified as: (1) Graded borders, (2) Level borders. Graded borders have slope ranging from 0.1–0.5% in the longitudinal directions and there is no or very little slope across the strip. For level border, there is no slope in either direction.

- 2. Check basin method (beds and channel)** - It is the common and simple method of irrigation mainly adopted in levelled land surface. It is also known as Beds and channel method of irrigation. The land is divided into small basins/beds. The area of basin is surrounded by earthen bunds or levees or dykes. The applied water is kept within the basin and not allowed for run off. This is the most common method adopted for most of the crops. The size of the levees or ridges or bunds depend upon the depth of water to be impounded in the basin. The water is turned on the upper side and after applying the required quantity of water it is turned off.



Fig. 11.2 Check basin method of irrigation

(a) Suitability**Soils**

- More efficient (more than 90%) in fine textured soil. This is due to the uniform rapid spread of water and more infiltration opportunity time for all areas and thereby depth of infiltration is uniform all along the basins.
- The correct quantity of water can be applied as there is no run off.
- Leaching of salt is possible by impounding water and giving more opportunity/time for infiltration, stagnation and drainage.
- Suitable to lands with smooth, gentle and uniform slope with low to medium infiltration rate.

Crops - Cereals, millets, pulses, oilseeds.

(b) Disadvantages

- It needs high degree of levelling for uniform distribution of water.
- Within the basin, soil should be uniform.
- It is not suitable for coarse textured soil with high infiltration rate.
- The bunds should be strong enough to withstand ponding of water.
- In fine textured soil with very low infiltration rate, precaution may be taken to avoid long time water stagnation.

(c) Dimensions - The basin area for different soil types, inflow rate and slope percentage are given below for reference. The size of the basin is also influenced by the depth (in mm) of irrigation water. If the required irrigation depth is large, the basin can be large. Similarly, if the required irrigation depth is small, then the basin should be small to obtain good water distribution.

Table 11.4. Maximum Basin Areas (M²) for various Soil Types and Available Stream Sizes (L/Sec) (Lps)

<i>Stream size (L/Sec)</i>	<i>Sand</i>	<i>Sandy loam</i>	<i>Clay loam</i>	<i>Clay</i>
5	35	100	200	350
10	65	200	400	650
15	100	300	600	1000
30	200	600	1200	2000
60	400	1200	2400	4000
90	600	1800	3600	6000

Check Basins should be small if the slope of the land is steep; soil is sandy, stream size to the basins is small, required depth of the irrigation application is small and field preparation is done by hand or animal drawn implements.

Check Basins can be large if the slope of the land is gentle flat, soil is clayey, stream size is large, required depth of the irrigation application is large and field preparation is mechanized.

Based on the shape of the basin, it can be classified as rectangular or square or irregular basin. Mostly, the rectangular shape is preferable for easiness in farming operations.

- Basin method** - Basin method of irrigation is used in soil submergence method of irrigation in low land rice, bunded rainfed rice and forage grasses, where water is stagnated to the required

depth by providing bunds on all the sides to sufficient width and height. The optimum size for efficient water management to rice crop is 0.25-0.40 ha. The field is to be levelled thoroughly for uniform depth of water. Provision of separate irrigation and drainage channels is more efficient than field-to-field irrigation.

Table 11.5. Average Width and Range of Width based on Slope Percentage

<i>Slope percentage</i>	<i>Average</i>	<i>Range</i>
0.2	45	35–55
0.3	37	30–45
0.4	32	25–40
0.5	28	20–35
0.6	25	20–30
0.8	22	15–30
1.0	20	15–25
1.2	17	10–20
1.5	13	10–20
2.0	10	5–15
3.0	7	5–10
4.0	5	3–8

4. **Ring basin** - This method is mostly adopted for wide spaced orchard crops. The rings are circular basins formed around the individual trees. The rings between trees are interlinked with main lead channel by sub channels to get water to the individual rings. As water is allowed in rings only, wastage of water spreading the whole interspaces of trees as in the usual flooding irrigation method is reduced. Weed growth in the interspaces around the rings are discouraged. This method ensures sufficient moisture in the root zone and saves lot of irrigation water.



Fig. 11.3 Ring basin

5. **Furrow method of irrigation** - It is the common method adopted for row planted crops like cotton, maize, sugarcane, potato, beetroot, onion, sorghum, vegetable crops etc. In this method, small evenly spaced shallow furrows or channels are formed in the beds. Another method of furrow irrigation is forming alternate ridges and furrows to regulate water. The water is turned at the high end and conveyed through smaller channels. Water applied in furrows infiltrate slowly into the soil and spread laterally to wet the area between furrows.

A. Dimensions

Based on the soil slope and stream size, the length can be fixed. The furrow width or spacing varies from 60–120 cm, which depends upon the crop to be grown. The depth of furrow varies from 12.5 cm, which depends upon (a) soil type, (b) flow size, and (c) effective root zone depth of crop.

B. Suitability

This method is mostly suitable for medium to moderately fine textured soil which allows free water movement both horizontally and vertically. In sandy or coarse textured soil, this method is not suitable because here the water movement is primarily downward and very little in horizontal direction. Besides, the length of ridges or furrows to resist the velocity of flow is very low which in turn may lead to breaching of the structures. This method is adopted for soils having the problem of surface crust or hardpan. The labour requirement to form the furrows is relatively higher than other surface methods of irrigation.

C. Precautions

While using the furrow method of irrigation, care must be taken in strengthening the furrow since erosion hazard on sloppy areas may damage the furrow. To work out the maximum non-erosive flow in the area, the below mentioned empirical formula can be used.

$$Q = \frac{0.60}{S}$$

Where,

Q	=	Maximum non-erosive stream in lps.
0.60	=	Constant
S	=	Slope of the furrow in percentage

Irrigation furrows may be classified into two general types viz., straight furrow and contour furrow.

Straight furrow - Best suited to soils where land slope does not exceed 0.75%.

Contour furrow - This method is similar to graded and level furrow method. Furrow carries water across slopping field rather than downwards. They are designed to fit the topography of field. Furrows are given a gentle slope along its length as in graded furrow. Field supply channels run down the land slope to feed the contour furrow and are provided with erosion control structure. Successfully used in all irrigable soils. All row crops including grains, vegetables and cash crops are adapted to this method. Light soil can be irrigated successfully across slopes up to 5% slope. Up to 8-10% can be irrigated by contour furrow. Contour furrow may be used on all types of soil except in light sandy soil and soil that crack.

Corrugation irrigation - It consists of running water in small furrows, which direct the flow down the slope commonly used for irrigation in non-cultivated close growing crops such as small grains, pasture on steep slopes. Corrugation can be made with a simple bamboo corrugation or cultivators equipped with small furrows. Corrugations are 'V' or 'U' shaped channels about 6-10 cm deep spaced 40-75 cm apart. This method is not recommended for saline soil or for saline water irrigation. The permissible length of corrugation varies from 15 cm within light textured soil with slopes of 2-4% to about 150 cm in heavy texture soil up to 2% slope.

Furrow irrigation design consideration - Efficient irrigation by furrow method is obtained by selection of proper combination of spacing, length and slope furrows.

- (i) **Furrow spacing** - Furrows can be spaced to fit the crops grown and types of machines used for planting and cultivation. Crops like potato, maize, cotton, etc., are planted 60–90 cm apart and have furrow between all rows. Carrot, lettuce and onion are spaced 30–40 cm and often have two rows between furrows. Furrows should be close enough to ensure that water spreads to the sides of the ridge and the root zone of crop to replenish soil moisture immediately.
- (ii) **Furrow length** - Optimum length furrow is usually the longest furrow that can be efficiently and safely irrigated. Long furrows are an advantage in inter cultivation. Proper furrow length depends largely on hydraulic conductivity of soil. It should be shorter in porous sandy soil than clayey soil. If only a small area is to be irrigated, the length of field may determine the length of furrow. In large area it may be desirable to have furrow length equal to an even fraction of the total length of the field.
- (iii) **Furrow slope** - The slope or grade of furrow is important because it controls the speed at which water flows down the furrow. A minimum furrow gradient of 0.05% is needed to ensure Surface drainage.
- (iv) **Furrow stream** - The size of the furrow stream is one factor which can be varied after furrow irrigation system can be installed. The size of furrow stream usually varies from 0.5-2.5 lit/sec. The max nonerosive low rate in furrow is estimated by following equation,

$$q_m = 0.6/S$$

where,

$$q_m = \text{maximum no-erosion stream (lit/sec)}$$

$$S = \text{Slope of furrow (\%)}$$

Average depth of irrigation water applied during irrigation can be calculated by the following relationship.

$$D = (q \times 360 \times t)/(w \times l)$$

Where

$$D = \text{Average depth of water applied (cm)}$$

$$q = \text{Stream size (lit/sec)}$$

$$t = \text{duration of irrigation (hrs)}$$

$$l = \text{Furrow length (m)}$$

$$w = \text{Furrow width (m)}$$

6. **Surge irrigation** - Surge irrigation is a method of surface irrigation through furrows or border strips wherein water is applied intermittently in a series of relatively short on and off time periods during the irrigation (Humphrey, 1989). Water is let into a long furrows or border strips in an intermittent flow instead of conventional continuous flow. Each flow is termed as a surge. Surge irrigation practiced under favourable conditions can improve the performance of surface irrigation system compared to the other methods of surface irrigation. Irrigation is given in an on-off cycle or by cut back method. The cycle time means the time from the beginning of one surge to the beginning of next surge. Cycle ratio is the ratio of flow time (continue) to the cycle time. Assuming the cycle time as 20 minutes and cycle ratio as 1:2 (0.5), the on-time is 10 minutes and off time is 10 minutes. This cycle ratio can also be the ratio of on-time and off-time as 1:1, if the on time is 10 minutes. Water is allowed for 10 minutes and stopped for 10 minutes. This 20 minutes is the surge time or cycle time. This surge is repeated until the water reaches the whole furrow or strip.

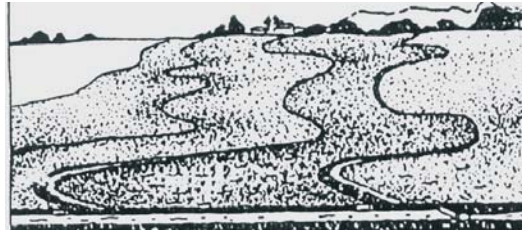

Fig. 11.4 Contour irrigation

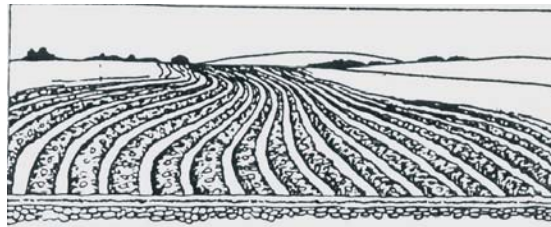

Fig. 11.5 Graded contour-furrow Irrigation



Fig. 11.6 Corrugated irrigation

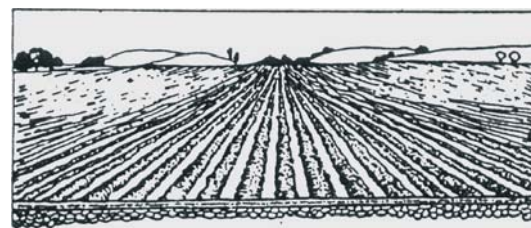

Fig. 11.7 Graded or level-furrow irrigation: Different types of furrow irrigation

The first surge of water over a portion of dry furrow wets the soil surface at a slow advance rate and high infiltration rate. When the next surge is allowed to flow along the first surge length, water makes faster to the second surge length. Thus in surge flow, the advancing water along the furrow is faster resulting in uniform wetting from the head to the tail end of furrow. Under the conventional continuous flow, wetting is more in head end than at tail end. When more water is allowed to increase the wetting depth in the tail end, it leads to loss of water through tail end run off. This loss and the rate of infiltration along the whole length of flow distance are reduced in surge irrigation, in addition to saving time of irrigation.

Advantages

- Reduction in infiltration rate
- Rapid advance of wetting front
- Less difference in intake opportunity between upper and lower ends of furrow
- More uniform distribution of water along the length
- Improvement in application uniformity and irrigation efficiency
- Reduces water requirement
- Water reaches the furrow end much earlier than under continuous stream
- It is a non erosive method, suitable for erodable soils
- Useful for light textured soils with high infiltration rate
- Saves irrigation time and the energy cost for lifting water
- About 20% of land area is saved in cross channels with shorter furrow lengths
- It offers scope for automation of surface irrigation.

Limitations

- Little or no advantage in clay or silty soils
- Tail end water loss may increase if not managed properly
- Lengthy furrows of more than 100 m are required
- Ensuring proper gradient to such lengthy furrows is difficult
- With progress in surge cycles and number of irrigations, the bulk density is increased due to soil consolidation
- More suited to shallow rooted crops only.

II. Subsurface irrigation

Water is applied below the ground surface through the network of pipes or some devices. The main aim of this type of irrigation is to reduce the evaporation loss and to maintain an artificial water table near the root zone of the crop.

Suitability - It is mainly suitable for the high temperature area where ET losses are very high wherein controlling and maintenance of surface water and application is very difficult.

Pitcher pot irrigation method - It is one way of applying water below the ground or soil surface. In this method, in a mud pot, some small holes are made and the holes are closed by either threads or material, which is able to conduct water very quickly. The pots are kept around the root zone in pits made for it. The pits are completely covered tightly with sand mulch mix. The pots are filled with water and closed. The water slowly penetrates to root zone through the holes and wet the root zone area. This method is mostly suitable for widely spaced tree crops under water scarce conditions.

III. Pressurized irrigation methods

It includes both sprinkler and drip irrigation methods where water is applied through network of pipelines by means of pressure devices.

1. **Sprinkler irrigation system/point source method** - In this method the irrigation water is sprayed to the air and allowed to fall on-the ground surface more or less resembling rainfall. The sprinkling of water or spray of water is made by pumping water under pressure through network of pipelines and allowing to eject out by means of small orifices or nozzles or holes. The water

required by the crop is applied in the form of spray by using some devices, wherein the water application rate should be somewhat lesser than the soil infiltration rate to avoid run off or stagnation of water in the field.

Suitability and advantages

- It is highly suitable for sandy soil where infiltration rate is more.
- For shallow soil where levelling operation is technically not possible.
- For lands having undulating topography or steep slopes where levelling is economically not advisable.
- Irrigation stream size is very small where surface flow is low.
- It is almost suitable for all crops except crops like rice, which needs stagnation of water, but under water scarcity it can be tried for rice also. For cotton during reproductive phase sprinkler irrigation is not advisable.
- Application of fertilizer (fertigation), pesticides (pestigation) and herbicides (herbigation) are possible through irrigation systems which reduce labour cost and increase the use efficiency of any chemical.
- It controls crop canopy temperature.
- In crust soil, it facilitates early germination and establishment by means of light and frequent irrigation.
- Wastage of land for basin, ridges and furrows and irrigation channels are reduced.

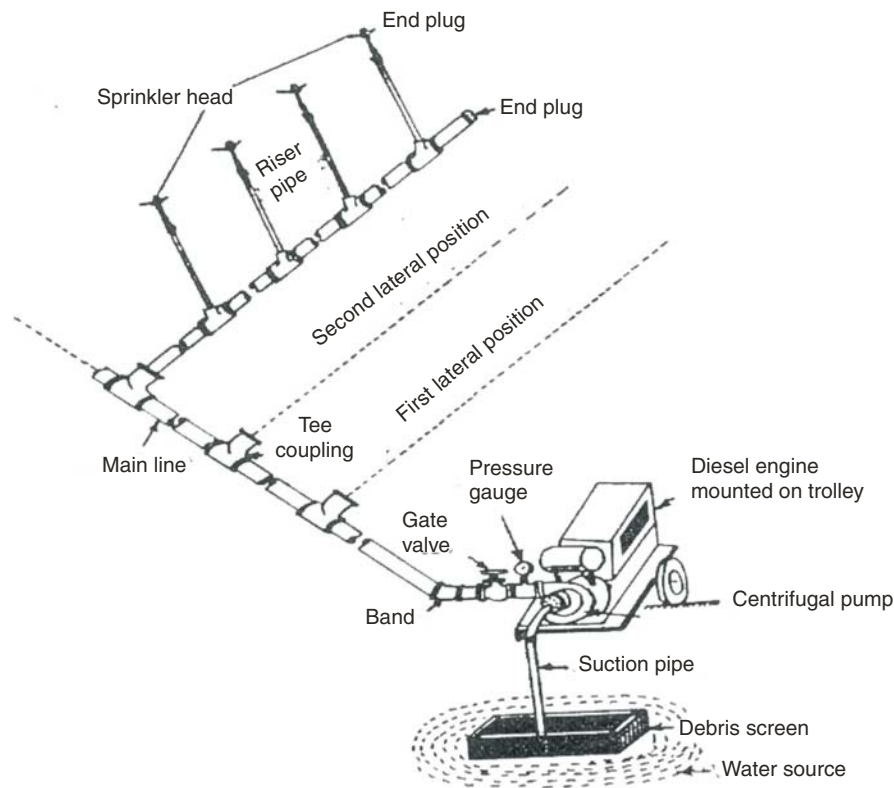

Fig. 11.8 Components of a sprinkler irrigation system

Disadvantages

In heavy windy areas the distribution efficiency is reduced due to drifting of water droplets. In saline water conditions, it causes leaf burns besides clogging and corrosion of the pipeline. Continuous power supply is required to operate the system to maintain pressure. It is very costly to install and to maintain. Uniformity of application is difficult due to over application or neglected corners in the field.

Major components

- Pump set
- Network of pipelines (main, lateral, sub lateral, etc.)
- Riser pipes with tripod stand
- Sprinkler head

Classification - There are two types viz., (1) Rotation head system and (2) Perforated pipe system. Further it can be classified as:

- Portable* - All components are portable and fixed
- Semi portable* (or) *Semi Permanent* - Water source, pump set, main and sub mains are fixed. Only laterals are portable.

(a) **Rotating head system** - A special device to sprinkle the water called “Sprinkler Head” is used in this system. The sprinkler head consists of small nozzles and metal ring or vane with a spring. The water ejected through the nozzle strike the metal ring which changes its direction by the help of the spring attached to this which in turn causes the spray of water in all directions. The whole sprinkler

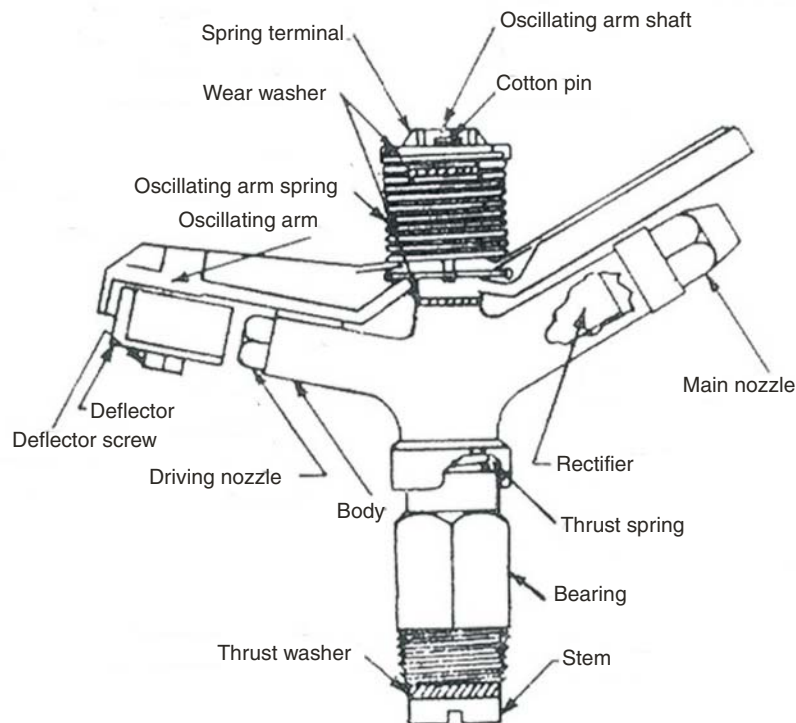

Fig. 11.9 Twin nozzle rotating type sprinkler head

head system is fitted on the riser pipe, which is erected from lateral pipes at uniform intervals. Rotating sprinkler heads are of two types *viz.*, single nozzle type and twin nozzle type (main nozzle and driving nozzle).

(b) **Perforated pipes system** - In this method, small holes are made in lateral pipes based on the nature of the crops to distribute water uniformly.

Uniform distribution of water - Irrigation efficiency of sprinklers depends upon the degree of uniformity of water applied. Uniformity coefficient is computed with field application. Open cans are placed at regular interval within sprinkled area. Depth of water collected in open cans is measured and the coefficient of uniformity is computed by Christiansen (1942) equation.

$$C_u = 100 (1 - \Sigma X/m.n)$$

Where,

- C_u = uniformity coefficient
 m = average value of all observations
 n = total number of observation points
 X = numerical deviation of individual observation from average application rate.

A uniformity coefficient of 85% or more is considered to be satisfactory. The uniformity coefficient is affected by pressure–nozzle size relation, sprinkler spacing and wind condition.

Sprinkler selection and spacing - The choice depends on diameter of coverage required, pressure available and discharge of sprinkler. The data given in tables 1 and 2 may serve as guidance in selecting the pressure and spacing desired.

Table 11.6. Maximum Spacing of Sprinklers under Windy Condition

<i>Average speed of wind</i>	<i>Spacing</i>
No wind	65% of the diameter of the water spread area of sprinkler
0–6.5 km/hr	60% of the diameter of the water spread area of sprinkler
6.5–13 km/hr	50% of the diameter of the water spread area of sprinkler
Above 13 km/hr	30% of the diameter of the water spread area of sprinkler

The discharge of an individual sprinkler is calculated using the following formula

$$q = (sl \times sm \times r)/360 \text{ where,}$$

q = required discharge of individual sprinkler (lit./sec)

sl = Spacing of sprinkler along the laterals (meter)

sm = Spacing of sprinkler along the main (meter)

r = Optimum application rate (cm/hr)

Height of sprinkler rise pipe

$$Q = (2780 \times A \times D)/(F \times H \times E)$$

Where,

- Q = Discharge capacity of pump (lit/sec)
 A = Area to be irrigated (ha)
 D = Net depth of water supplied (cm)
 F = Number of days allowed for completion of irrigation

- H = Number of operating hours/day
 E = Water application efficiency (%)

Table 11.7. Choice of Nozzle size, Spacing of Sprinkler and Sprinkler rotation to types of Sprinklers

Types of sprinkler	Gravity fed under free sprinkler system	Normal under free sprinkler system	Permanent over head system	Small over head system	Low pressure system	Inter mediate pressure system	High pressure system
Pressure range (kg/cm ²)	0.7-1.0	1.0-2.5	3.5-4.5	2.5-4	1.5-2.5	2.5-5	5-10
Sprinkler discharge (lit./sec)	0.06-0.25	0.06-0.25	0.2-0.6	0.6-2.0	0.3-10.0	2-10	10-50
Diameter of nozzles	1-6 mm	1.5-6 mm	3-6 mm	6-10 mm	3-6 mm	10-20 mm	20-40 mm
Diameter of coverage	10-14m	6-23 m	30-45 m	25-35 m	20-25 m	40-80 m	80-140 m
Range of sprinkler spacing	–	–	18-30 m	9-24 m	9-18 m	24-54 m	54-100 m
Recommended speed of sprinkler rotation	–	0.5-1 rpm	1 rpm	0.67-1 rpm	0.5-1 rpm	0.7 rpm	0.5 rpm

Rate of application - Average rate of application is often called as precipitation intensity. It can be estimated by

$$Ra = Q/(360 \times a)$$

Where,

- Ra = Rate of water application
 Q = Discharge rate of sprinkler (lit/sec)
 A = Wetted area of sprinkler (m²)

Discharge of nozzle - The discharge of water through the nozzle can be given by the following equation.

$$Q = ca - \sqrt{2} gh$$

Where,

- Q = Nozzle discharge
 a = Cross-sectional area of nozzle
 h = pressure head at nozzle (mts.)

- Head of water = 10 × pressure (bar)
 Head of water foot = 2.31 × pressure (Pounds foot/inch 2)
 G = Acceleration due to gravity
 C = Discharge coefficient

Water spread area of sprinkler - The water-spread area of a sprinkler is given by the following equation

$$R = 1.35 \sqrt{dh}$$

R = Radius of wetted area (m)
 d = Diameter of nozzle
 h = pressure head at nozzle (m)

Design of sprinkler systems - A sprinkler system is designed in order to achieve high efficiency in its performance and economy. The informations needed for designing sprinkler system are:

- map of area
- water source availability and dependability
- climatic condition
- depth of irrigation to be applied
- irrigation interval
- water application rate
- sprinkler spray and power source

Lay out of sprinkler system - Sprinkler operates at a low time duration and pressure and can irrigate an area of 9–24 m wide and up to 300 m long at one setting. Application rate vary from 5–35 mm/hr.

Layout of portable system - It consists of a pump, mainline, lateral and rotary sprinkler spacer 9–24 m apart. The laterals remain in position until irrigation is completed. After irrigation is over, lateral is disconnected from main and is dismantled and moved to the next point of main line and reassembled. The lateral is gradually moved around the field until the whole field is irrigated. In this system, only laterals are moved. Sometimes the whole system including pump and mainline are moved from point to point (semi permanent).

Permanent system - When sufficient laterals and sprinklers are provided to cover the whole irrigated area so that no equipment needed to be removed. Then the system is called permanent system. This system requires less labour than portable system and large area can be irrigated by using few skilled operators. They are more expensive initially because of extra pipes, sprinklers and fittings required but, savings can be made because of reduced labour. It is suitable for automation irrigation system and areas where labour is difficult to obtain.

Fertilizer application with sprinkler system - Suitable chemical fertilizers can be mixed into the sprinkler system and applied to crop. Quantity of fertilizer added to the system for each setting can be calculated by using the formula.

$$wf = (Ds \times Dl \times Ns \times Wf)/10,000$$

where,

wf = Amount of fertilizer per setting
 Ds = Distance between sprinklers
 Ns = Number of sprinklers
 Wf = Recommended fertilizer dose
 Dl = Distance between laterals.

2. Drip or Trickle Irrigation System/line source irrigation

Water is applied through network of pipelines and allowed to fall drop by drop at crop root zone by a special device called emitters or drippers. These drippers or emitters control the quantity of water to be

dropped out. In this system, the main principle is to apply the water at crop root zone based on the daily ET demand of the crop without any stress. Hence, the root zone is always maintained at field capacity level.

Components

- Overhead tank or pressure system (Motor pumps).
- Main Lines - To take water from source to field which is usually made of black poly alkathene pipes having an inner diameter of 50 mm

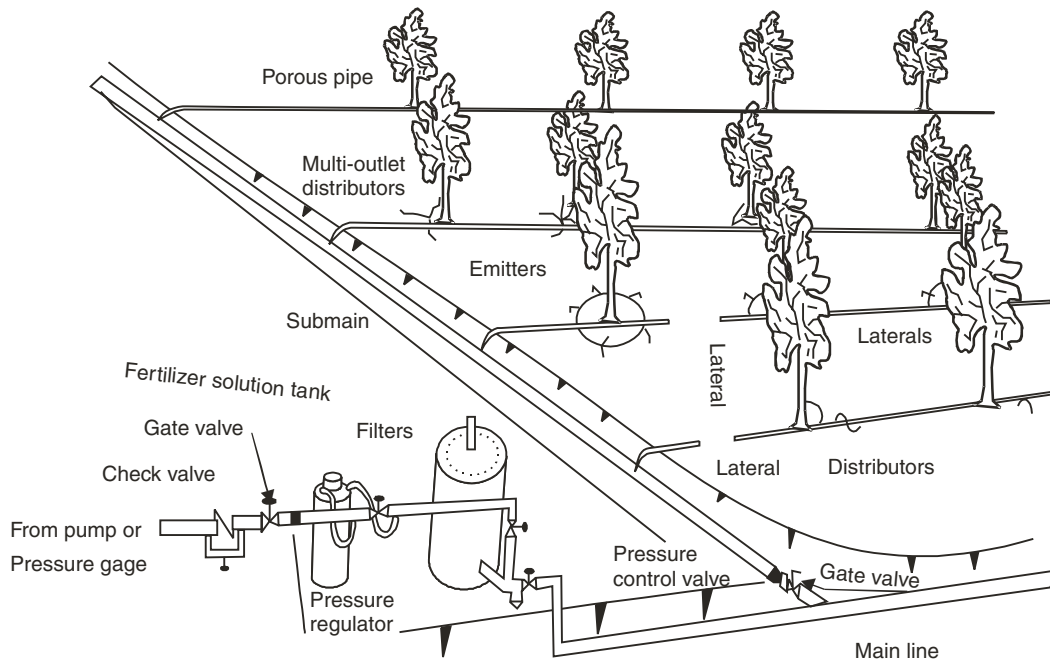

Fig. 11.10 Drip Irrigation System

Sub main - If the area is larger, the sub mains are used to take water from main pipes to field which is normally having an inner diameter of 37 mm.

Laterals - These pipelines are normally having lesser diameter than mains and sub mains usually of 12 mm made of black poly alkathene pipes which deliver water from main or sub mains to crop root zone. The length of lateral depends upon the pressure created in pump as well as spacing of the crop and length of the field. Normally about 25 m length of lateral can be adopted to have a uniform distribution of water.

Emitters - Emitters control the water drops and the quantity of water to be delivered. Various designs of drippers with various discharge capacity are available (5, 7, 8, 10 and 20 lph, etc. Button types, spray type, tap type etc.). Instead of drippers micro tubes are inserted into the laterals and water is allowed to drip in the root zone of crops or trees.

Advantages

- Application of water in slow rates facilitates the easy infiltration into the soil.

- The required quantity of water is applied near the root zone alone which in turn save water.
- The root zone is always maintained with field capacity level and hence plants do not suffer for want of water.
- There is no seepage or percolation or evaporation losses.
- Weed growth is restricted due to limited area of wetting zone.
- Fertilizers (fertigation), chemical like pesticides (chemigation) and herbicide (herbigation) can be applied through irrigation. Hence, saving of input quantity and labour cost besides increase in their use efficiencies is possible.
- Reduce the salt content near the root zone and dilute it in saline soil.
- The saline water also can be put under use if irrigation is applied through drip irrigation.
- It can be adopted for any type of topography.
- Yield increases due to optimum maintenance of soil moisture at root zone.
- More area can be maintained with little quantity of water.
- It can be used for widely spaced crops like cotton, sugarcane, tomato, brinjal, coconut and orchard crops.

Disadvantages

- Clogging in emitters due to salt content of water and other impurities like moss, dust etc.
- Damage of pipe lines by rodents.
- It is not economical for closely spaced crops which require more number of pipes and drippers per unit area.
- Proper maintenance and periodical cleaning of drippers and pipelines (with 1% hydrochloric acid) are very important to maintain the system efficiency.

3. Rain gun

Features of the raingun - Raingun is a powerful mega sprinkler that throws a large amount of water (upto 500 liters per minute) to a good distance (radius of 90 feet and even more) as artificial rain. It offers a number of benefits to the farmer. It reduces water consumption by 50 per cent as compared to flood irrigation in achieving the same yield. As a result of the reduced water consumption with the raingun irrigation system, large savings accrue. Irrigation time comes down (60 percent time is saved) and power consumption comes down. Also, raingun irrigation is less labour intensive than flood irrigation. It increases crop yield by 10 percent as sugarcane farmers have experienced. Fertilizers can also be applied with the raingun irrigation system, reducing consumption of fertilizers. Irrigation with the raingun washes away pests like aphids, white flies etc. The raingun irrigation systems supports the highly recommended practice of trash mulching in sugarcane, which is a process of converting trash into nutrient for the crop. As the cane grows, the trash is stripped from the cane so that the cane is protected from pests and diseases. At the same time, the trash is valuable as it has a lot of nutrients. However, farmers do not make ready use of this available nutrient and resort to clearing it or setting it on fire to manage the huge quantity of trash. Mulching is a practice whereby the trash is used as a soil cover to aid moisture retention, prevent proliferation of weeds and the trash itself is eventually converted into nutrition. The raingun irrigation system gives farmers the ability to practice trash mulching successfully.

While the raingun has been developed with sugarcane in mind, it can also be applied with excellent results to a number of other crops such as groundnut, tapioca, onion, potato, maize and forage crops etc.

Permanent system - In permanent system of installation raingun riser stands are permanently fitted to solid set pipeline network. Riser can also be supported by cement concrete block around the riser.

Semi permanent system - In semi permanent system pipeline network can be permanent and raingun riser stand or only raingun shifted from one location to other. Raingun fiser stand can be made detachable by using HDPE Quick-Connect™ male connector at riser and Quick-Connect™ female connector at pipe end. HDPE pipe in coil/hose of required size and length attached with G.I. insert joint on one end and Quick-Connect™ female joint on the other end, can also serve as the pipe network. Alternatively, raingun alone can be shifted over permanently installed risers using quick release key and/or quick coupling valve.

Shiftable system - In shiftable system entire pipeline network along-with raingun riser stand and raingun can be shifted from one location to another. Easily detachable Quick-Connect™ pipes are used for this purpose. Quick-Connect™ pipes can be connected to raingun riser stand using male connector. Flexible HDPE coil/hose can also be used in shiftable system. Raingun trolley can be used for easy movement of raingun from one place to other.

11.8 IRRIGATION SYSTEMS

In India, various types of irrigation systems are in practice. The following are some important system.

- Gravity irrigation
- Tank irrigation
- Lift irrigation

11.8.1 Gravity Irrigation

Here water is supplied to the land by gravitational flow. There are two types namely (i) Perennial, (ii) Inundation.

- (i) **Perennial** - In this system, water is assured throughout the crop period from the reservoir. This may be either direct or indirect irrigation. In direct irrigation, river water is directly directed to canal by constructing diversion weirs across the river without storing water at any point, where adequate perennial supply of water is assured to feed the canal during the cropping period. In indirect irrigation, during monsoon period water is stored in dam or any reservoirs and directed to flow during cropping season and hence also called as storage irrigations. This is adopted where the river flow is inadequate in cropping period. This has got significant importance than direct one.
- (ii) **Inundation** - In this system, the water is directed to canal without any diversion work. It depends on the periodical rise in water levels of the river and supply is drawn through natural coarse or open which acts as Head.

11.8.2 Tank Irrigation

It is the oldest irrigation system of India wherein water is stored by forming a big bund across the natural drainage to avoid the surface runoff loss through natural streams. The tank size varies according to the drainage capacity. It has irrigation capacity from 10–1000 ha. It is further classified as:

- (a) *System tank* - The system tank receives allotted quantity of water from river system during the cropping period for its command.
- (b) *Non-system tanks* - The Non-system tanks depend upon rainfall in their catchment area and do not have any link to river system to get water.

11.8.3 Lift Irrigation

In this system, water is lifted from a reservoir or river or canal or well by using mechanical or electrical power to irrigate the field. Lift irrigation includes: (1) lift canal irrigation, (2) well irrigation, and (3) tube well irrigation.

11.9 MEASUREMENT OF IRRIGATION WATER

Irrigation water is measured because it is a valuable resource and scarce commodity and measurement helps to reduce excessive use, wastage and allows optimum water use, uniform distribution, increases conveyance, distribution, application and usage efficiencies. Water measurement is essential in the operation and maintenance of any irrigation system, lay out of irrigation structures, layout and planning of irrigation projects and for drawing cropping programmes.

11.9.1 Methods

Measurement of irrigation water may be done by

- Volumetric method,
- Velocity area method,
- Direct discharge method, and
- Tracer method.

A. Volumetric method

Materials required - Plastic bucket, alkathene pipe and stop watch.

Procedure - A known volume of bucket or barrel (210 litre) is taken and placed under the delivery end of a pump or pipe. The time taken to fill the bucket/barrel is recorded using stopwatch. The rate of flow of water in a water pipe or a pump set is worked out by using the formula.

$$\text{Discharge rate (lit/sec)} = \frac{\text{Volume of bucket (lit)}}{\text{Time taken to fill the bucket (sec)}}$$

B. Velocity area method

This method is used to determine the discharge rate in a pipe or open channel by multiplying the cross-sectional area of flow at right angles to the direction of flow by the average velocity of water.

$$\text{Rate of flow/Discharge rate} = \text{Area (a)} \times \text{velocity (v)} \text{ (in m}^3\text{/sec)}$$

$$a = \text{Area of cross-section of a channel or pipe (m}^2\text{)}$$

$$v = \text{Velocity of flow (m/sec)}$$

There are important methods under the velocity area method to find out the velocity of flowing water.

- Float method,
- Using current meter, and
- Water meters,

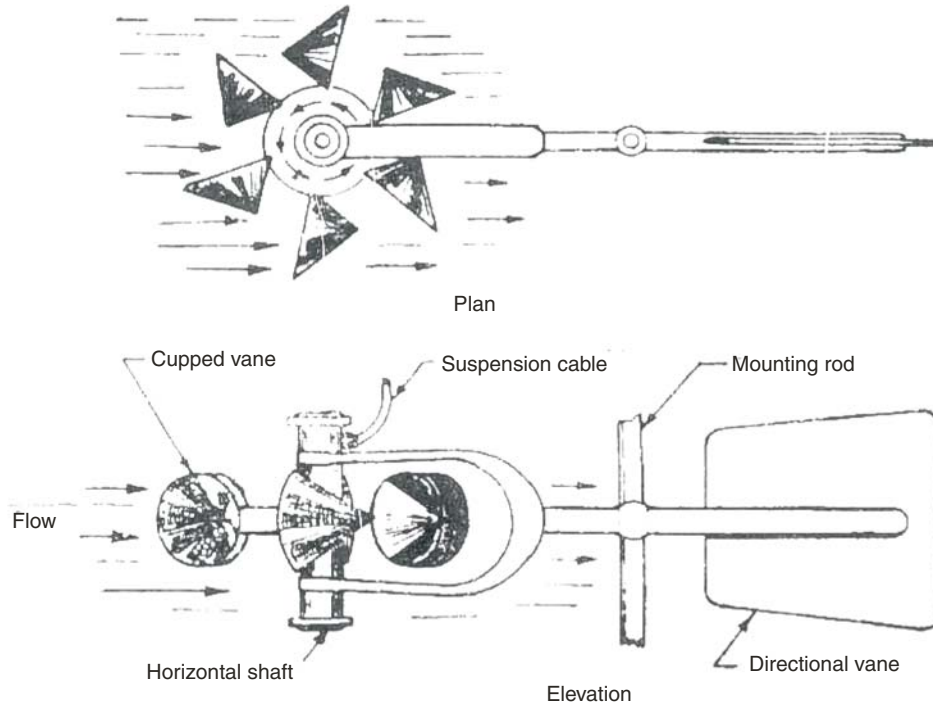

Fig. 11.11 Current Meter

- (a) **Float method** - Here, the rate of movement of floating body over flowing water is equated to the velocity of running water with a co-efficient of 0.85.

Materials required - A rubber ball or a closed empty plastic bottle or a block of wood or any floating material, measuring tape, stop watch etc.

Procedure - Measure 40 m length in a straight channel and mark the upstream (A) and downstream (B) points. Allow the float to float on the running water at A, the upstream point. Note the time when it touches the upstream point and let this be the initial time. Also note the time when it reaches the down stream point (B) which will be the final time. Repeat the procedure several times and find out the mean time to travel this 40 m distance. The velocity is determined by the following relationship.

$$\text{Velocity} = \frac{\text{Length of channel (m)}}{\text{Average time taken by float (sec)}} \times 0.85 = \text{m/sec}$$

The average velocity is calculated by multiplying a co-efficient factor (0.85) as above. The flow rate of the water is worked out using the formula $Q = a \times v$

Rate of flow (Q) = average velocity \times cross sectional area of the channel.

- (b) **Using current meters** - It is a small instrument containing a revolving wheel or vane that is rotated by the movement of water. The number of revolutions of the wheel in a given time is noted and corresponding velocity is reckoned from a calibration table/graph.
- (c) **Using water meters** - Water meters utilize a multiplied propeller made of metal, plastic or rubber, rotating in a vertical plane and geared to a totalizer, which totalizes the flow in any desired volumetric units. To use the water meter at all times accurately, the flow of water should

be full and the rate of flow must exceed the minimum for the rated range. Meters are calibrated and no field adjustments are necessary. Care should be taken to avoid obstruction due to foreign materials in the propeller.

C. Direct discharge methods

In this method, the volume of flow of water is determined directly by installing certain devices of known dimensions at a desired point across the channel. The most commonly used devices for measuring the irrigation water are: (1) Weirs/notches, (2) flumes, (3) orifices, and (4) pipes and siphon tubes. These devices are used to measure the rate of flow commonly read, on a scale and computing the discharge of flow from standard formula or table.

Water measuring devices

(i) **Weirs** (ii) **Flumes** (iii) **Orifices** (iv) **Pipes and Siphon tubes**

- | | | |
|----------------|-------------------|-------------------|
| 1. Triangular | 1. Parshall flume | 1. Free flow |
| 2. Rectangular | 2. Cut throat | 2. Submerged flow |
| 3. Trapezoidal | 3. Trapezoidal | |

I. Weirs

A weir is an opening provided in a structured bulkhead of timber or concrete through which water is made to flow. It is used to measure the flow in an irrigation channel or the device may be built as stationary structures or portable.

Precautions

- The weir should be set at the lower end of the long pool sufficiently wide and deep to give smooth flow of the stream.
- The weir wall must be vertical and not leaning to the upstream or downstream.
- The center line of the weir should be parallel to the direction of flow.
- The crest of the weir should be levelled so that water passing over it will be of same depth at all points along the crest.
- The notch should be a regular shape and its edges must be rigid and straight.
- The crest of the weir is placed high enough so that water will fall freely leaving an air space under falling sheet of water.
- The depth of water flowing over the rectangular weir should not be less than 5 mm and not more than two thirds of the crest width.
- Measurement should be made using a scale located at a distance of about four times the head.

Limitations

- Not accurate unless measurements are properly maintained
- Require considerable loss of head
- Not easily combined with turn out (diversion) structures
- Not suitable for water carrying silt.

The general formula for determining the discharge through a weir

$$Q = CLmH$$

Where,

- Q = Discharge (lps)
 C = Co-efficient depending upon the nature of weir crest and channel approach conditions

L = Length of crest known as crest head causing flow
 m = The power value depending upon the shape of the notch
 H = Head on the crest

Types of Weirs

(a) *Triangular weir (90 Degree 'V' Notch)* - 'V' Notch is commonly used to measure small and medium size streams. The advantage of the V notch is its ability to measure small flows accurately. Typical dimensions are given in figure. It is found to measure discharge up to 113 lps. The discharge through a 'V' notch may be computed by the formula.

$$Q = 0.0138 H^{5/2}$$

Where

Q = Discharge in litre/sec

H = Head in cm

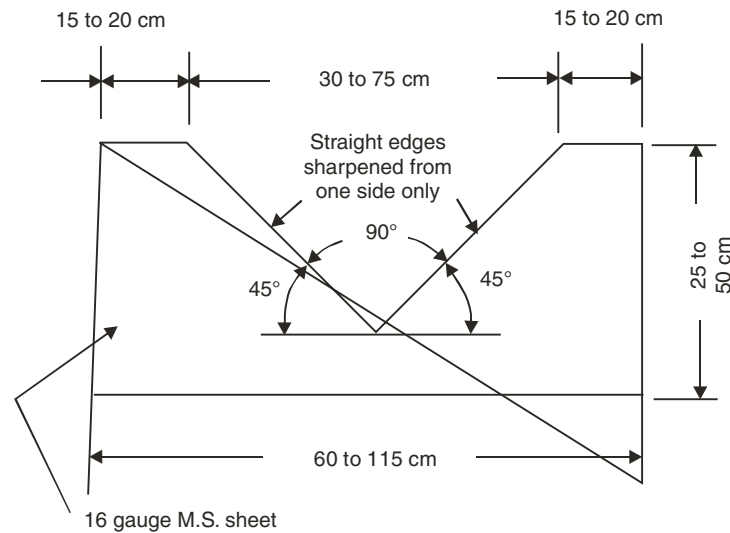

Fig. 11.12 Triangular weir

(b) *Rectangular weir* - The rectangular weirs are used to measure comparatively large discharge. It has horizontal crest and vertical sides. They may be (i) Contracted rectangular weirs or suppressed rectangular weirs. The discharge through rectangular weirs may be computed from the Francis formula

Contracted rectangular weir $Q = 0.0184 (L-0.1H)^{3/2}$ (one end contraction)

Contracted rectangular weir $Q = 0.0184 (L-0.2H)^{3/2}$ (two end contraction)

Contracted rectangular weir $Q = 0.0184 LH^{3/2}$ (no end contraction)

Where,

Q = Discharge (lit/sec)

L = length of crest (cm)

H = Head over weir (cm)

(c) *Trapezoidal weir (Cipoletti weir)* - The cipoletti weir named after the inventor, is a special type of trapezoidal weir. Each side of the weir has a slope of 1 horizontal to 4 vertical. It is used to measure medium discharge. Since the discharge through the triangular portion balances the loss due to end contractions no correction is necessary for end contractions. The discharge through cipoletti weir is computed by the following formula.

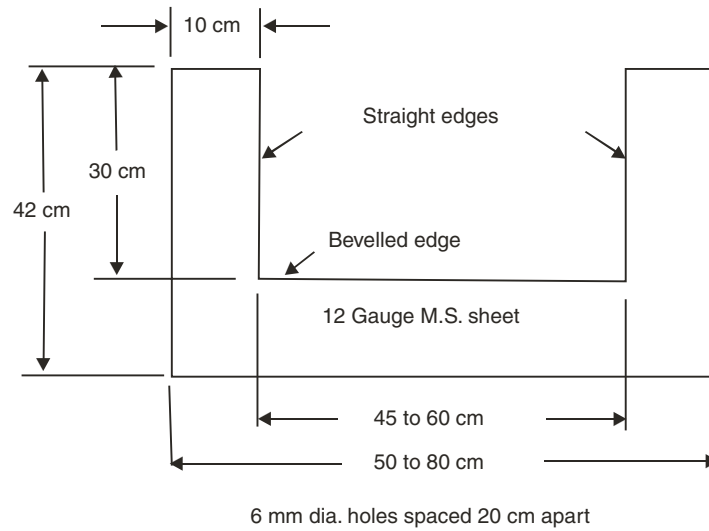

Fig. 11.13 Rectangular weir

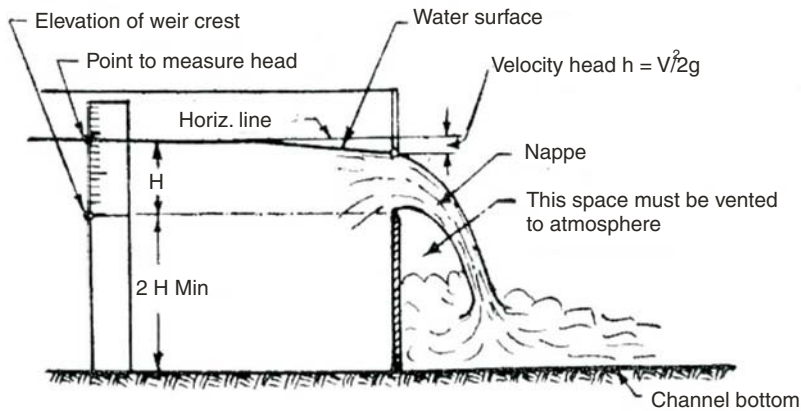

Fig. 11.14 Sectional view of weir installation

$$Q = 0.0186 LH^{3/2}$$

Where,

Q = Discharge (litre/sec)

L = length of crest (cm)

H = Head over the crest (cm)

II. Flumes

(a) *Parshall flumes (venturi flume)* - This has been developed by Parshall (1950) and hence named after him. This parshall flume is an open channel type measuring device that operates with a small drop in head. It is a self-cleaning device and hence sand or silt in the flowing water does not affect operation or accuracy. It gives reasonably accurate measurement even when partially submerged. The flumes of 7.5, 15, 23 and 30 cm sizes are generally used in field measurements.

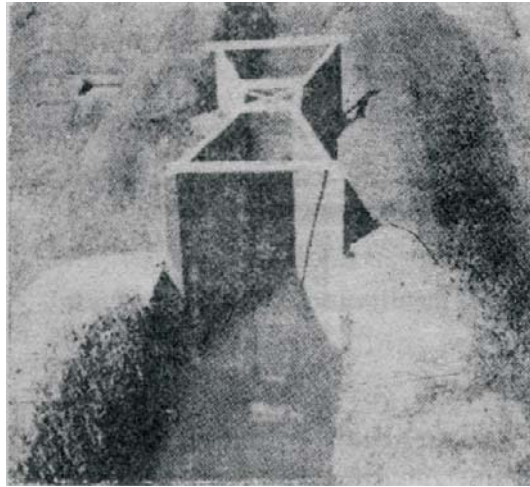

Fig. 11.15 Parshall flume

- (b) *Cut-throat flume* - There is an improvement in construction details over parshall flume. It is developed by Skogerboe *et.al.*, (1967). The flume has a flat bottom, vertical walls and no throat section. The flume width ranges between 2.5 cm–1.8 m. The cut-throat flume may be used either in free flow or in submerged flow condition. It should be installed in a straight section of the channel and not near gate because of unstable and surging effects, which might result from the gate operation. However, it is better to have a flow-measuring device to operate under free flow condition.
- (c) *Trapezoidal flume* - It is somewhat similar to rectangular flume and devised based on the study of Robinson Chamberlin (1958). The characteristics are listed as follows:
- A large range of flows can be measured through the structure with a comparatively smaller change in head.
 - The flumes will operate under submergence than rectangular shaped ones without correction being necessary to determine the exact relationship.
 - Extreme approach conditions and sediments deposited in the approach does not affect the head discharge relationships.
 - The trapezoidal shape fits the common canal section more closely than the rectangular one.
 - Construction details such as transmission and frame work are simplified

III. Orifices

Orifices are the circular or rectangular openings in vertical bulkhead placed across the stream. They may operate under free flow or submerged flow conditions. Under free flow conditions the flow from the orifice discharges entirely into air forming a nappe. If the orifice is fully submerged, the downstream water level is above the top of the opening and the flow is disturbed into the down stream water. A plastic scale is fixed on the upstream face of the orifice plate in such a way that zero of the scale coincides with the center of the orifice.

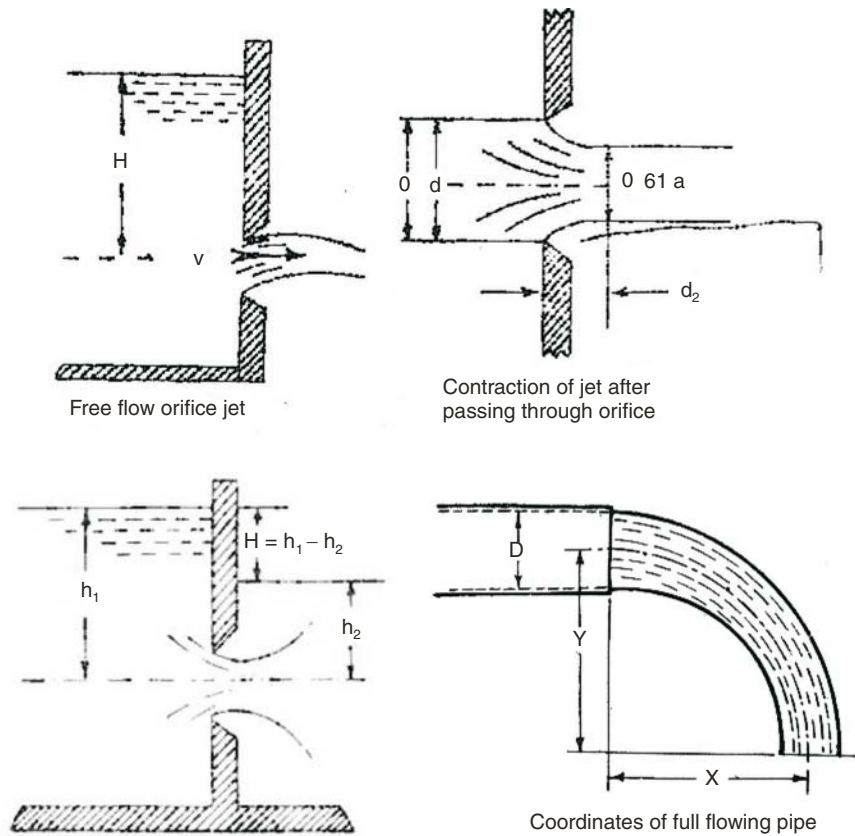

Fig. 11.16 Head in submerged orifice

The discharge is calculated by the formula

$$Q = 0.61 \times 10^{-3} a \sqrt{2gh}$$

Where

- Q = discharge in litres/sec
- a = area of cross-section of the orifice in cm²
- g = acceleration due to gravity in cm/sec
- h = depth of water over center of orifice in cm.

In case of submerged flow orifice the difference in elevation between upstream and downstream is measured as 'h'.

IV. Pipes and Siphon tubes

The trajectory of stream of water from a horizontal pipe can be used to estimate the discharge. Such a procedure is rapid, inexpensive and convenient. Measurement is made for the x and y coordinates, where x is measured parallel to the pipe and y is measured vertically. Horizontal measurement of the jet (x) is measured from the end of the pipe to the centre of the jet in cm distance from the centre of the pipe to the ground *i.e.*, vertical coordinate is measured in cm (y). The discharge formula is obtained by combining the three equations.

$$Y = \frac{1}{2}gt^2 \quad X = Vtq = av$$

$$V = (x\sqrt{g})/\sqrt{2}Y$$

$$Q = (Ca \times \sqrt{g})/\sqrt{2}Y$$

Where,

- Q = Discharge in lit/sec
 C = Coefficient of discharge
 g = Acceleration due to gravity
 a = Cross sectional area of water at end of pipe in cm²
 coordinate of the point on the surface to the pipe measurement in cm.
 y = Vertical coordinate measured in cm
 x = Horizontal coordinate

Vertical pipe - When water flows vertically out of an open pipe, the height to which it will rise above the pipe is proportional to the flow. Lawrence and Brawnworth made careful measurements and found that the height of the jet was less than 0.37 dp., where dp is the inside diameter of the pipe, then flow is sub critical. When the jet height exceeds 1.4 dp, water discharges from the pipe with supercritical flow in jet flow. The discharge from a vertical pipe can be estimated using the equation given by Lawrence and Brawnworth in metric system as

$$\begin{aligned} Q \text{ for } h_s < 0.37 \text{ dp} &= 5.47 \text{ dp } 1.25 h_s 1.35 \\ Q \text{ for } h_s > 1.4 \text{ dp} &= 3.15 \text{ dp } 1.99 h_s 0.53 \\ Q &= 0.0195D^2X/Y \end{aligned}$$

Where,

- Q = Discharge in lit/sec
 D = Diameter of the pipe
 X = Vertical coordinate (from pipe end to the top of the jet)
 y = Horizontal coordinate (from centre of pipe to the centre of nappe)

Siphons - Siphons are provided to deliver water from a ditch furrow of check dam. The rate of flow of water delivered by siphons may be measured by knowing the area of cross-section and head as given in the formula

$$Q = 0.65 \times 10^{-3} A^2 \sqrt{gh}$$

Where,

- Q = Discharge from siphon tube in lit/sec
 A = Cross-section in cm²
 g = Acceleration due to gravity (cm²/sec)
 h = Head causing flow in cm

For free flow, the head causing flow 'h' is the height of water in the ditch above the centre of the inlet end of siphon tube and when submerged, the differences in level between layers in the ditch and furrow is the 'h'.

V. Tracer method

Tracer methods of water measurement are independent of stream cross-section and are suitable for field measurements without installing fixed structures. In these methods, a tracer substance in concentrated form is introduced into the flowing water and allowed to mix thoroughly. The concentration of the tracer is measured at a downstream section. Since only the quantity of water necessarily to accomplish the dilution is involved, there is no necessary to measure velocity, depth, head, c.s. area etc. After assessing the amount of water to be applied to the soil and the type of water measuring device, the irrigator is to work out the time duration to supply water. This method is yet to become popular in India.

11.10 IRRIGATION SCHEDULING

Irrigation scheduling is defined as the frequency with which water is to be applied based on needs of the crop and nature of the soil. Irrigation scheduling is nothing but number of irrigations and their frequency required to meet the crop water requirement. Irrigation scheduling may be defined as scientific management technique of allocating irrigation water based on the individual crop water requirement (ETc) under different soil and climatic condition, with an aim to achieve maximum crop production per unit of water applied over an unit area in unit time. Based on the above definition, the concept made is:

“If we provide irrigation facility, the agricultural production and productivity will go up automatically”.

Irrigation scheduling is a decision-making process repeated many times in each year involving when to irrigate and how much of water to apply? Both criteria influence the quantity and quality of the crop. It indicates how much of irrigation water to be used and how often, it has to be given.

Excess irrigation is harmful because:

- it wastes water below root zone
- it results in loss of fertilizers nutrients
- it causes water stagnation and salinity
- it causes poor aeration
- ultimately it damages the crops

However, irrigation scheduling has its own meaning and importance according to the nature of the work.

For irrigation engineers - Irrigation scheduling is important to cover more area with available quantity of water or to satisfy the whole command from head to tail reach in the canal or river system.

For soil scientists - It is important that the field should not be over irrigated or under irrigated as both will spoil the chemical and physical equilibrium of the soil.

For Agronomists - It is very much important to get higher yield per unit quantity of water in normal situations and to protect the crop to get as much as possible yield under drought situation by means of supplying water in optimum ratio and minimizing all field losses.

A. Importance

How much and how often water has to be given depends on the irrigation requirement of the crop.

Irrigation requirement (IR) = Crop water requirement (CWR)-Effective rainfall (ERF)

i.e., IR = WR - ER in mm/day or mm/month.

If the crop water requirement of a particular crop is 6 mm per day, it means every day we have to give 6 mm of water to the crop. Practically it is not possible since it is time consuming and laborious. Hence, it is necessary to schedule the water supply by means of some time intervals and quantity. For example the water requirement of 6 mm/day can be scheduled as 24 mm for every 4 days or 30 mm for every 5 days or 36 mm for every 6 days depending upon the soil type and climatic conditions prevailing in that particular place. While doing so, we must be very cautious that the interval should not allow the crop to suffer for want of water.

B. Practical considerations

Before scheduling irrigation in a farm or field or a command, the following criteria should be taken care for efficient scheduling.

Crop factors

- Sensitiveness to water shortage
- Critical stages of the crop
- Rooting depth
- Economic value of the crop

Water delivery system

- Canal irrigation or tank irrigation (It is a public distribution system where scheduling is arranged based on the decision made by public based on the resource availability).
- Well irrigation (Farmer's decision is final).

Type of soil

- Sandy-needs short frequency of irrigation and less quantity of water
- Clay-needs long frequency of irrigation and more quantity of water

Salinity hazard - To maintain favourable salt balance, excess water application may be required rather than ET requirement of the crop to leach the excess salt through deep percolation.

Irrigation methods - Basin method allows more infiltration through more wetting surface which in turn needs more water and long interval in irrigation frequency. Furrow method allows less infiltration due to less wetting surface which needs less water and short interval in irrigation frequency. Sprinkler method needs less water and more frequency. Drip method needs less water and more frequency.

Irrigation interval - The extension of irrigation interval does not always save water. The interval has to be optimized based on the agro climatic situation.

Minimum spreadable depth - We cannot reduce the depth based on the water requirement of the crop alone. The depth should be fixed based on the soil type, rooting nature of the crop and irrigation method followed. The minimum depth should be so as to achieve uniformity of application and to get uniform distribution over the entire field.

C. Theoretical approaches

I. Direct approach

- Depth interval and yield approach
- Soil moisture deficit and optimum moisture regime approach

- Sensitive crop approach
- Plant observation method
- Indicator plant technique
- Micro plot technique

II. Indirect or predictive approach

- Critical stage or phenological stage approach
- Meteorological or climatological approach

III. Mathematical approach

- Estimation method approach
- Simple calculation method
- Simulation approach-computing and modelling
- Empirical approach

IV. System as a whole approach

- Rotational water supply schedule

I. Direct approach

(a) **Depth interval and yield approach** - In this method, different depths of irrigation water at different time intervals fixed arbitrarily are tried without considering the soil and weather characters. The irrigation treatment which gives the maximum yield with minimum depth and extended interval is chosen as the best irrigation schedule. Earlier workers have adopted this practice to work out the duty of water for different crops in many irrigation projects. It is the rough irrigation schedule. Hence, many irrigation projects which have adopted this practice have failed to achieve the full efficiency.

Disadvantages

- Rainfall is not taken into account
- Ground water contribution is not taken into account
- Soil parameters are not taken for calculating irrigation requirement and hence this approach is not useful.

(b) **Soil moisture deficit and optimum moisture regime approach** - This approach considered soil moisture content in the root zone of the crop for fixing the schedule. When the soil moisture reaches a pre fixed value, may be 40% of Available Soil Moisture (ASM) or 50% ASM or 60% ASM, irrigation is given. The degree of depletion is measured through percentage of availability by using gravimetric, tensiometer, resistance block, neutron probe, etc.

Disadvantages

- Soil moisture alone is taken into account
- Hence, it cannot be taken for all type of soil in particular region
- It varies from soil to soil.

(c) **Sensitive crop approach** - The crops that are grown for their fresh leaves or fruits are more sensitive to water shortage than the crops, which are grown for their dry seeds or fruits. Based on their sensitivity, the crops can be indexed as:

<i>Low</i>	<i>Low to Medium</i>	<i>Medium to high</i>	<i>High</i>
cassava	alfalfa	beans	banana
millet	cotton	citrus	cabbage
red gram	maize	soybean	fresh green vegetables
	groundnut	wheat	rice, sugarcane
			sunflower
			tomato

(d) **Plant observation method** - Normally in field condition, farmers use to adopt this practice for scheduling irrigation. The day-to-day change in plant physical character like colour of the plant, erect nature of plant leaves, wilting symptoms, etc., are closely and carefully observed on the whole and not for individual plant and then time of irrigation is fixed according to the crop symptoms. It needs more skill and experience about the crop as well as local circumstances like field condition, the rainy days of that tract etc.

Disadvantage

- No accuracy in finding the crop water need
- Sometimes sensitive symptoms are evident only after reaching almost the wilting point.

(e) *Indicator plant technique* - Crops like sunflower and tomato are highly sensitive to water stress, which will show stress symptom earlier than other stress tolerating crops. Hence, to know the stress symptoms earlier such sensitive crops are planted at random in the field and based on the stress symptoms noticed in such plants, scheduling of irrigation can be made. This technique is called indicator plant technique.

(f) *Micro plot technique or indicator plot technique* - In this method, one cubic feet micro plot is made with coarse textured soil to have more infiltration, less water holding capacity and more evaporation than the actual main field. Normally the field soil is mixed with sand in 1:2 ratio and refilled in the micro plots made in the field. The seed of the same crop and variety is grown in micro plot with all similar cultural practice as that of the main crop. The crops in micro plot show early stress symptoms than that of main field. Based on this, scheduling of irrigation can be made.

II. Predictive approach or indirect approach

(a) **Critical stage or phenological stage approach** - The growth period of an annual crop can be divided into four growth stages.

- | | |
|--------------------------|-------------------------------------|
| • Initial stage | : From sowing to 10% ground cover. |
| • Crop development stage | : 10–70% ground cover. |
| • Mid season stage | : Flowering to grain setting stage. |
| • Late season stage | : Ripening and harvesting stage. |

The stage at which the water stress causes severe yield reduction is known as critical stage of water requirement. It is also known as moisture sensitive period. Moisture stress due to restricted supply of water during the moisture sensitive period or critical stage will irrevocably reduce the yield. Provision of adequate water and fertilizer at other growth stages will not even help in recovering the yield loss due to stress at critical periods. In general, the mid season stage is the most sensitive stage to water shortage

because the shortage during this period will be reflected significantly on yield. For most of the crops, the least sensitive stages are ripening and harvesting except for vegetables like Lettuce, Cabbage etc., which need water up to harvesting. Under scarce condition, in an irrigation project or in a farm, if mono cropping is followed with staggered sowing or planting, it is better to schedule irrigation to crop which has reached mid season stage since it is the most critical stage. The sensitive stages vary from crop to crop as given below.

Sensitive stages of different crops

<i>Crops</i>		<i>Critical stages/ Sensitive stages</i>
Cereals and millets		
Rice	–	Active tillering, panicle initiation, heading and flowering
Sorghum	–	Flowering and grain formation
Maize	–	Tasselling, silking and milky stages
Cumbu	–	Heading and flowering
Ragi	–	Primordial initiation and flowering
Wheat	–	Crown root initiation, tillering and booting
Oil seeds		
Groundnut	–	Flowering, peg initiation and pod formation and pod development
Sesame	–	Blooming to maturity
Sunflower	–	Two weeks before and after flowering
Soybean	–	Blooming and seed formation
Safflower	–	From rosette to flowering
Castor	–	Full growing period
Cash crop		
Cotton	–	Flowering and Boll formation
Sugarcane	–	Maximum vegetative stage
Tobacco	–	Immediately after transplanting
Vegetables		
Onion	–	Bulb formation to maturity
Tomato	–	Flowering and fruit setting
Chillies	–	Flowering and fruit setting
Cabbage	–	Head formation to maturity
Legumes		
Alfalfa	–	Immediately after cutting for hay and flowering for seed crops.
Beans	–	Flowering and pod setting
Peas	–	Flowering and pod formation
Others		
Coconut	–	Nursery stage root-enlargement
Potato	–	Tuber initiation and maturity
Banana	–	Throughout the growth
Citrus	–	Flowering, fruit setting and enlargement
Mango	–	Flowering
Coffee	–	Flowering and fruit development

At critical stages, favourable water level should be ensured through timely irrigations.

(b) *Meteorological approach/Climatological approach* - The basic principles employed with this approach are estimation of daily potential evapotranspiration rates. Hence, it requires knowledge on short term evapotranspiration rates at various stages of plant development, soil water retention characteristics, permissible soil water deficit in respect to evaporative demand and effective rooting depth of the crop grown. The irrigation scheduling is based on the cumulative pan evaporation and irrigation depth or Irrigation at ratio of irrigation water (IW) and cumulative pan evaporation (CPE).

$$R = \frac{IW}{CPE} = \frac{\text{depth of water to be applied per irrigation (mm)}}{\text{Cumulative pan evaporation for particular period (mm)}}$$

For example, for ten days cumulative pan evaporation at the rate of 10 mm per day equal to 100 mm (CPE). Irrigation depth to be given is 50 mm. Therefore IW/CPW ratio is

$$R = \frac{IW}{CPE} = \frac{50 \text{ mm (depth)}}{100 \text{ mm (CPE)}} = 0.5$$

Like this, many ratios have to be tried and find the best yield-performing ratio, which can be adopted for scheduling irrigation. The irrigation depth (IW) for different crops are fixed based on the soil and climatic conditions. The ratio of IW/CPE that gives relatively best yield is fixed for each crop by doing experiment with different ratios, for different soil types and growth stages. The irrigation depths (IW) divided by the ratio (R) will give the cumulative pan evaporation value at which irrigation is to be made *i.e.*, $IW/R = CPE$. For example, the irrigation depth (IW) needed is 50 mm and the ratio (R) to be tried is 0.5, therefore, the Cumulative Pan evaporation value needed to irrigate the field is,

$$IW/R = 50/0.5 = 100 \text{ mm}$$

If the 100 mm of CPE is attained in 10 days (pan evaporation @ 10 mm per day), once in 10 days irrigation is to be given.

Advantages - Gives best correlation, compared to other formulae where climatic parameters and soil parameters (depths) are considered.

Disadvantages - This approach is subject to marked influence by selecting pan site. For example,

- U S W B class A open pan evaporimeter reading from June to December amounted to 130 cm when pan is sited on grass field, 150 cm when pan is sited on dry land with stretch of grass, 176 cm when pan is sited on dry land without stretch of grass
- Pan readings generally over estimate ET during early stage and maturity stage.

III. Mathematical approach

A. Estimation method approach

It is nothing but scientific prediction mainly based on the climate and soil type. Calculated crop water need and estimated root depths are taken into account in this.

(a) *Soil type*: Soil types are classified as follows:

- Sandy/shallow – Little water and more frequency
- Loamy soil – More water and less frequency

- Clay soil – More water and less frequency

(b) *Climate*: Climate is classified based on reference ET as follows:

Reference ET

- 4-5 mm/day – Low
- 6-7 mm/day – Medium
- 8-9 mm/day – High

Table 11.8. Reference ET (mm/day) for different Climatic Zones

<i>Climatic zone</i>	<i>Mean daily temp.</i>		
	<i>15 °C Low</i>	<i>15–25°C Medium</i>	<i>> 25°C High</i>
Desert/arid	4–6	7–8	9–10
Semi arid	4–5	6–7	8–9
Sub humid	3–4	5–6	7–8
Humid	1–2	3–4	5–6

The above table is based on the crop water needs during peak period. It is also assumed that there is no rainfall or little occurs during the growing season. Based on this method estimated irrigation schedule is given below for major field crops.

Table 11.9. Estimated Irrigation Schedule for Major Field Crops in Peak Periods

	<i>Intervals in days</i>											
	<i>Sandy</i>				<i>Loamy</i>				<i>Clay</i>			
<i>Climate</i>	<i>1</i>	<i>2</i>	<i>3*</i>	<i>Depth</i>	<i>1</i>	<i>2</i>	<i>3*</i>	<i>Depth</i>	<i>1</i>	<i>2</i>	<i>3*</i>	<i>Depth</i>
Banana	5	3	2	25	7	5	4	40	10	7	5	55
Cotton	9	6	5	40	11	8	6	55	14	10	7	70
Sorghum	8	6	4	40	11	8	6	55	14	10	7	70
G. nut	6	4	3	25	7	5	4	35	11	8	6	50
Maize	8	6	4	40	11	8	6	55	17	10	7	70
Peas	6	4	3	30	8	6	4	40	10	7	5	50
Soybean	8	6	4	40	11	8	6	55	14	10	7	70
Sugarcane	8	6	4	40	10	7	5	55	13	9	7	70
Sunflower	8	6	4	40	11	8	6	55	14	10	7	70
Wheat	8	6	4	40	11	8	6	55	14	10	7	70
Tomato	6	4	3	30	8	6	4	40	10	7	5	50

1* – Low temperature of 15°C, 2* – Medium temperature of 15 – 25°C, 3* – High temperature of > 25°C

Adjustment in this method for Non peak periods

In early growth stages - The irrigation could be adjusted with little water and same frequency. But same water and less frequency is not advisable.

In late growth stage - Less frequency with same amount of water is advisable in this period.

In rainy days - The table schedule is to be adjusted when there is contribution from rainfall during crop growth period. This can be adjusted by giving longer interval (high frequency) with little water.

For irrigation practice and soil characteristics - For example, if a maize crop is grown on a clayey soil in a moderately warm climate, according to the table, the interval is 10 days and the depth is 70 mm per application. But based on the irrigation method practiced and soil type, the soil is unable to hold 70 mm of water per application. The soil could hold only 50 mm per application. In this situation instead of giving 70 mm for every 10 days, it is possible to give 63 mm for every 9 days or 56 mm for every 8 days or 49 mm for every 7 days or 42 mm for every 6 days. The 49 mm for every 7 days is the appropriate interval for local situation. Hence, this method of intervals for irrigation can be adopted.

B. Simple calculation method

It is based on the estimated depth of irrigation application and calculated irrigation need of the crop over growing season. Hence, the influence of climate especially temperature and rainfall is taken for consideration. Hence, it is more accurate than that of the estimated method. It involves four steps viz.,

- Estimate the net and gross irrigation depth (d) in mm.
- Calculate the irrigation water need (mm) over total growing season.
- Calculate the number of irrigation over total growing season.
- Calculate the irrigation interval.

Calculation of irrigation water need for total growing season

e.g. Tomato crop is planted in February 7th and harvested in June 30th.

Water need mm/month

February	March	April	May	June	Total
67	110	166	195	180	718

Calculate the number of irrigation over total growing period

$$\text{Number of irrigation} = \frac{\text{Total water need}}{\text{Depth}}$$

$$= \frac{718}{40} = 18$$

$$\text{Irrigation interval} = \frac{\text{Duration (days)}}{\text{Number of irrigation}}$$

$$= \frac{150}{18} = 8.3$$

(c) *Simulation method approach* - This is noting but construction of mathematical models with essential features and behaviour of real system. Adoption of such models to get solution by computers and studying the property of such models in relation to those of prototype system is followed. In this, all the complex components like supply system, soil, climatic condition; crop, cultural practices, crop responses and plant nutrient level are considered to work out the model.

(d) *Empirical methods* - Many empirical methods have been developed to estimate Evapotranspiration values of the crop. Among this, modified Penman, Blaney and Griddle methods have much acceptability among Researchers. The estimated values of ET crop by the different methods were compared with the actual values. The error of different methods are as follows:

Method	Error Value (%)
Penman	14.2
Pan evaporation	10.3
Blaney and Griddle	11.9

1. Modified Penman method

The form of the equation used in this method is:

$$ET_o = c [W \cdot Rn + (1 - w) \cdot f(u) \cdot (ea - ed)]$$

(Radiation term) (Aerodynamic term)

Where,

ET_o	=	reference crop Evapotranspiration in mm/day
W	=	temperature-related weighting factor
Rn	=	net radiation in equivalent evaporation in mm/day
$F(u)$	=	wind related function
$(ea - ed)$	=	difference between the saturation vapour pressure at mean air temperature and the mean actual vapour pressure of the air, both in mbar.
c	=	adjustment factor to compensate for the effect of day and night weather conditions

2. Blaney and Criddle equation

The relationship recommended, representing mean value over the given month, is expressed as:

$$ET_o = c [p(0.46T + 8)] \text{ mm/day}$$

Where,

ET_o	=	reference crop Evapotranspiration in mm/day for the month considered
T	=	mean daily temperature in °C over the month considered
P	=	mean daily percentage of total annual daytime hours

obtained from Table 1 for a given month and latitude
(Refer: "Crop Water Requirement, FAO Irrigation and
Drainage Paper No. 24")

c = adjustment factor which depends on minimum relative
humidity, sunshine hours and daytime wind estimates.

After determining ET_o , ET crop can be predicted using the appropriate crop coefficient (kc), or $ET_{crop} = kc \times ET_o$.

3. Hargreaves temperature method

$$ET_o = 0.0023 \times RA(T_c M7.8) \times TDO.5$$

$$ET_o = PET$$

RA = Extraterrestrial radiation (mm/day)

$$T_c = \frac{T_{max} + T_{min} \text{ in } ^\circ C}{2}$$

$$TD = T_{max} - T_{min} \text{ in } ^\circ C.$$

Pan evaporation method - In this method, to work out the reference crop evaporation (ET_o) the pan factor and the pan evaporation readings are taken into account. The empirically derived pan coefficient (K_p) for different agro climatic zones is multiplied with pan evaporation (E_{pan}) to get Reference Crop Evaporation (ET_o).

$$ET_o = E_{pan} \times K_p$$

$$ET_c = ET_o \times K_c = E_{pan} \times K_p \times K_c$$

Where,

ET_c = ET from cropped field

ET_o = reference crop ET

K_c = Crop co-efficient

E_{pan} = pan evaporation reading

K_p = Pan co-efficient

Random equation for PET estimation

$$PET = 0.6 E_p \text{ mm/day}$$

Where,

E_p = Evaporation from USWB class A pan in mm/day.

The empirical formulae are used to estimate the net amount of water requirement of the crop. With this value, the special water demand like pre plant irrigation, leaching requirement and economically unavoidable irrigation, application losses are to be added for scheduling irrigation.

System as a whole approach

Rotational water supply - Rotational water supply is one of the techniques in irrigation water distribution management. It aims at equi-distribution of irrigation water irrespective of location of the land in the command area by enforcing irrigation time schedules. Each 10 ha. block is divided into 3-4 sub

units (irrigation groups). According to the availability of irrigation water, stabilized field channels and group-wise irrigation requirement, time schedules are evolved. The irrigation will be done strictly in accordance with the group-wise time schedules by the block committees. Within the group, the time is to be shared by the farmers within the group by themselves.

11.11 IRRIGATION MANAGEMENT

1. **Rice** - Total water requirement is 1100–1250 mm. The daily consumptive use of rice varies from 6–10 mm and total water ranges from 1100–1250 mm depending upon the agro climatic situation. Of the total water required for the crop, 3% or 40 mm is used for the nursery, 16% or 200 mm for the land preparation *i.e.*, puddling and 81% or 1000 mm main field irrigation. The growth of rice plant in relation to water management can be divided into four periods *viz.*, seedling, vegetative, reproductive and ripening. Less water is consumed during seeding stage. At the time of transplanting, shallow depth of 2 cm of submergence is necessary to facilitate development of new roots. The same water level is required for tiller production during the vegetative phase. At the beginning of the maximum tillering stage, the entire water in the field can be drained and left as such for one or two days which is termed as mid season drainage. This mid season drainage may improve the respiratory functions of the roots, stimulate vigorous growth of roots and checks the development of non-effective tillers. Any stress during the vegetative phase may affect the root growth and reduce the leaf area. During flowering phase 5 cm submergence should be maintained because it is a critical stage of water requirement. Stress during this phase will impair all yield components and cause severe reduction in yield. Excess water than 5 cm is also not necessary especially at booting stage, which may lead to delay in heading. Water requirement during ripening phase is less and water is not necessary after yellow ripening. Water can be gradually drained from the field 15–21 days ahead of harvest of crop. Whenever 5 cm submergence is recommended, the irrigation management may be done by irrigating to 5 cm submergence at saturation or one or two days after the disappearance of ponded water. This will result in 30% saving of irrigation water compared to the continuous submergence.
2. **Groundnut** - Total water requirement is 500–550 mm. Evapotranspiration is low during the first 35 days after sowing and last 35 days before harvest and reaches a peak requirement between peg penetration and pod development stages. After the sowing irrigation, the second irrigation can be scheduled 25 days after sowing *i.e.*, 4 or 6 days after first hand hoeing and thereafter irrigation interval of 15 days is maintained up to peak flowering. During the critical stages the interval may be 7–10 days depending upon the soil and climate. During maturity period, the interval is 15 days.
3. **Finger millet** - Total water requirement is 350 mm. Finger millet is a drought tolerant crop. Pre-planting irrigation at 7 and 8 cm is given. Third day after transplanting life irrigation with small quantity of water is sufficient for uniform establishment. Water is then withheld for 10–15 days after the establishment of seedling for healthy and vigorous growth, subsequently three irrigations are essential at primordial initiation, flowering and grain filling stages.
4. **Sugarcane** - Total water requirement is 1800–2200 mm. Formative phase (120 days from planting–germination and tillering phases) is the critical period for water demand. To ensure uniform emergence and optimum number of tillers per unit area, lesser quantity of water at more frequencies is preferable. The response for applied water is more during this critical phase during which the crop needs higher quantity of water comparing the other two phases. Water

requirement, number of irrigation etc., are higher during this period. As there is no secondary thickening of stem, elongation of stem as sink for storage of sugar it is desirable to maintain optimum level of moisture during grand growth period. Response for water is less in this stage and this will be still less in the ripening stage. During the ripening phase as harvest time approaches, soil moisture content should be allowed to decrease gradually so that growth of cane is checked and sucrose content is increased.

5. **Maize** - Total water requirement is 500–600 mm. The water requirement of maize is higher but it is very efficient in water use. Growth stages of maize crop are sowing, four leaf stage, knee high, grand growth, tasselling, silking and early dough stages. Crop uniformly requires water in all these stages. Of this, tasselling, silking and early dough stages are critical periods.
6. **Cotton** - Total water requirement is 550–600 mm. Cotton is sensitive to soil moisture conditions. Little water is used by plant with early part of the season and more is lost through evaporation than transpiration. As the plant grows, the use of water increases from 3 mm/day and reaching a peak of 10 mm a day when the plant is loaded with flowers and bolls. Water used during the emergence and early plant growth is only 10% of the total requirement. Ample moisture during flowering and boll development stages is essential. In the early stages as well as at the end the crop requires less water. Water requirement remains high till the boll development stage. If excess water is given in the stages other than critical stages it encourages the vegetative growth because it is a indeterminate plant thereby boll setting may be decreased. Irrigation is continued until the first boll of the last flush opens, and then irrigation is stopped.
7. **Sorghum** - Total water requirement is 350–500 mm. The critical periods of water requirement are booting, flowering and dough stages. The crop will be irrigated immediately after sowing. Next irrigation is given 15 days after sowing to encourage development of a strong secondary root system. Irrigation prior to heading and ten days after heading are essential for successful crop production.

Table 11.10. Water Requirement of different Crops

<i>Sl.No.</i>	<i>Crop</i>	<i>Duration in days</i>	<i>Water requirement (mm)</i>	<i>Number of irrigations</i>
1.	rice	135	1250	18
2.	groundnut	105	550	10
3.	sorghum	100	350	6
4.	maize	110	500	8
5.	sugarcane	365	2000	24
6.	ragi	100	350	6
7.	cotton	165	550	11
8.	pulses	65	350	4

11.12 ESTIMATION OF IRRIGATION EFFICIENCY

Water use efficiency - The water utilized by crop is evaluated in terms of Water Use Efficiency. This water use efficiency can be classified into:

- Crop Water Use Efficiency
- Field Water Use Efficiency

- Physiological Water Use Efficiency, and
- Irrigation project efficiency

(i) **Crop water use efficiency** - It is the ratio of Crop yield (Y) to the amount of water used by the crop for evapotranspiration (ET).

$$CWUE = \frac{Y}{ET} \text{ and expressed as kg/mm/ha}$$

(ii) **Field water use efficiency (FWUE)** - It is the ratio of crop yield (Y) to the total amount of water used in the field (WR)

$$FWUE = \frac{Y}{WR} \text{ and expressed as kg/mm/ha}$$

(iii) **Physiological water use efficiency (PWUE)** - The physiological WUE is calculated in terms of the amount of CO₂ fixed per unit of water transpired

$$PWUE = \frac{\text{Rate of photosynthesis}}{\text{Rate of transpiration}}$$

(iv) **Irrigation efficiencies of irrigation projects** - Many irrigation projects throughout the World operate with 25-40 per cent overall efficiency. Thus perhaps one third of the water released at the Project headwork is actually beneficially used for evapotranspiration by crops. In many areas increased irrigation efficiency would result in increased irrigation average and production as well as decreased problems with salinity and drainage. The decrease in efficiency can be attributed to losses occurring at various stages. Some of the reasons are:

- Inadequate design of the project.
- Inadequate design of the Farm Irrigation System.
- Lack of maintenance.
- Inadequate management of the system.

A typical Irrigation System consists of

- head works
- main canals
- field channels
- farm

A. Water application efficiency (Ea)

The purpose of irrigation is to replenish the available moisture in the root zone depleted by evapotranspiration. Crop water requirement is defined by Doorenbos and Pruitt (1977) as "The depth of water needed to meet the water loss through evapotranspiration of a disease free crop, growing in large fields under non-restricting soil conditions including soil water and fertility and achieving full production potential under the given growing environment". The application of the least amount of water required to bring the root zone moisture content up to field capacity is considered as efficient irrigation. If on the other hand, the amount of water applied grossly exceeds that actually needed for replenishment; the irrigator application efficiency is very low. To illustrate, consider a field, which needs 9 cm depth of water to bring the root zone to field capacity at the time of irrigation. To replace

this amount it is necessary to deliver a total or gross depth of 12 cm of water to the field. Then the efficiency of application will be

$$9/12 \times 100 = 75\%$$

$$\text{Application efficiency} = E_a = \frac{\text{Water required to bring soil to FC level}}{\text{Water received at field inlet}} \times 100$$

Primary factors for low application efficiency are:

- Improper Irrigation system design, construction.
- Poor maintenance of system.
- Inadequate farmers knowledge on crop water requirement.

Field application efficiency varies with type of soil and method of irrigation. Some observed efficiencies are given below:

Light soil	55%
Medium soil	70%
Heavy soil	60%
Graded border irrigation	53%
Basin irrigation	58%
Furrow irrigation	57%
Sprinkler irrigation	67%
Drip irrigation	80%
For rice cultivation, the efficiency is	32%

B. Conveyance efficiency (E_c)

$$E = \frac{\text{Water received at inlet to a block of fields}}{\text{Water released at project head works}} \times 100$$

Primary factors affecting conveyance losses are management aspects which cause fluctuations in the supply as well as physical factors such as seepage losses through canal banks and canal outlets. Some of the observed conveyance efficiencies are:

Continuous supply with no substantial change in flow	–	90%
Rotational supply with no substantial change in rotation	–	80% areas of 70–300 ha

Rotational Supply in projects more than 7,000 ha and less than 10,000 ha without effective management and communication – 65%–70% network

C. Project efficiency (E_p)

$$E_p = \frac{\text{Water made directly available to the crop}}{\text{Water released at head works}}$$

The overall project efficiency represents the efficiency of the entire operation between diversion of source of flow and the crop zone. Water delivery system improvements and farm irrigation improvements would significantly improve the ability of the farmer to apply more uniform and efficient irrigation. The Project Efficiency can be increased through

- Lining of canals in areas of high seepage losses, proper alignment and sectioning of field canals.
- Maintenance of canals and drains, including an emphasis on farm drains.
- Inducing scarcity of water by limiting available water per unit area.
- Ensuring reliability of supply system down to farmer's level. Farmers need to know when they can count on water and how much water much they can count on.
- Design farm systems so that release flow can be handled efficiently by the farmer.
- Install proper structures at outlets to maintain the flow constant.
- Encourage efficient design and construction of such system as level basins, contour borders and contour furrows and general land levelling and shaping.

11.13 IRRIGATION MANAGEMENT UNDER LIMITED WATER SUPPLY

Integration of all water resources like surface, ground water, wastewater, snow, dew etc., is most important to achieve maximum food production per unit quantity of water used to meet the demand from 1 billion population present. In this juncture, water resources itself become a constraint due to abnormality in distribution and uncertainty it in the occurrence of rainfall. Hence, at present frequent droughts are very common. Under these circumstances, a new water saving strategy has to be adopted in irrigation management and in crop production activities. This part of the chapter discusses about water scarce conditions and the ways to overcome it with some drought alleviating methods.

A. Water Scarcity Conditions

Water scarcity is the term used for poor storage or non-availability of required quantity of water for the purpose of crop production and otherwise due to failure of monsoons. The scarcity will lead to inadequate supply of water to the cropped fields, which in turn create a stress in plant community. This degree of stress varies depending upon the frequency of irrigation, nature of the crop, type of soil etc. In this situation our primary aim is to produce the maximum possible yield per unit quantity of water. The following are some management techniques under stress periods.

Assess resource potential - Based on the water potential, optimize the water use by linear programming techniques. This type of exercise should be done by the concerned department especially irrigation and agriculture.

Farmer's attitude - Farmer or user's behaviours need considerable reorientation to enable them to realize that water is an economic input and conservation of water is their prime responsibility.

Improvement in conveyance structure - A large quantity is lost through conveyance from source to field. It is estimated that about 30-40% of water is lost in conveyance systems. Reducing or totally preventing such losses of water can be made by proper maintenance, lining the channels etc. Conveyance by pipes is often adopted for ground water resource. Such conveyance may be made even at small sluice level in command areas.

Conjunctive use of water - Integrating all water resources with water conservation methods is termed as conjunctive use. Optimum use of water from different source is the main aim of conjunctive use. For example, in canal irrigation system the utilization of rainfall and well water optimally to protect the crop without eroding a single resource of water is termed as conjunctive use of water.

Contingent plant for rice - Rice is a semi-aquatic plant, which needs submergence of water for its establishment and better yield. The experimental evidences clearly indicated that 5 cm depth of ponding one day after disappearance of previously provided water is superior to higher depths. This was attributed to better aeration and consequently improved root activities.

Table 11.11. Yield under different Depth of Submergence in Rice

<i>Irrigation practice</i>	<i>Water applied (mm)</i>	<i>Grain yield (Kg/ha)</i>	<i>Water applied (mm)</i>	<i>Grain yield (kg/ha)</i>
Continuous submergence of 5 cm	1825	6300	1730	6000
5 cm One day after disappearance	961	6500	1200	6050
Water saving	47%	–	30%	–

This finding is helpful not only for micro level alone but also to change the water release pattern at macro level too and a turn system can be adopted in canal operation system. Further investigation reveals that 2 days dry spell in light textured soil and 2–3 days dry spell in heavy textured soil can be advocated without much yield reduction. If further scarcity arises, the next management techniques to save the rice crop is to adopt irrigation at critical stages. Different crop growth stages have different response to water stress. In rice crop the most sensitive periods for water stress are active tillering (AT), primordial initiation (PI), and flowering and milky stages. Dry spell during these periods will drastically reduce the yield.

B. Other Management Techniques

- Summer ploughing reduces runoff by increasing the infiltration and thereby reduces water needed for land preparation.
- Dry nursery with seed hardening technique (1% KCl) can be made which in turn will enhance the drought tolerance capacity.
- The short duration varieties like ADT 36, IR 36 and IR 50 can be chosen.
- During transplanting, it is enough to irrigate to a depth of 2 cm of water in the field. After that, maintaining 2.5 cm of water up to 12 days is sufficient.
- Application of herbicide within 3–5 days reduces the weed competition for water which in turn saves water considerably.
- After 12 days of transplanting, irrigating 5 cm of water one day after the disappearance of ponded water can be adopted not only to save water but also to increase the yield to some extent.
- Plastering field bunds and plugging of all crevices, rat and crab holes to avoid water loss through seepage.
- Proper levelling of the field.
- Water should be stopped 10–15 days before harvesting.
- Semidry rice (direct down) saves 30–40% water.
- Application of potassium in 3 split doses as 50% basal 25% at tillering and 25% at panicle initiation.
- Application of cycocel at the rate of 1000 ppm.

C. Drought Alleviating Methods for Irrigated Dry (ID) Crops

In ID crops, the main objective is to irrigate the crops to meet the requirement of ET need of the crops. Normally the ID crops are irrigated at certain intervals and mostly they are cultivated where conjunctive use of well water is available. So, chances for acute drought are very common on complete failure of monsoon. In this situation, adopting irrigation at critical stages save the crops from yield loss. Further, some drought alleviating chemical spray also protects the crops from severe loss.

1. Contingent plan for sugarcane

- Deep planting of sets in 30 cm deep and 30 cm wide trenches.
- Adopting irrigation at 0.75 and 0.5 IW/CPE ratio during tillering to grand growth and maturity phase, respectively *i.e.*, 8 to 9 days interval during tillering to grand growth and 13 to 15 days interval at maturity phase.
- Trash mulching to a thickness of 10 cm uniformly 3 days after planting to tide over drought by moisture conservation and to reduce weed incidence.
- Application of 2 to 3 per cent kaolin spray to mitigate the water loss through transpiration.
- Alternate furrow irrigation: Irrigate alternate furrows in rotation for each irrigation.
- Cultivating drought resistant varieties such as COC 85061, COC 8001, COC 671.

2. Contingent plan for groundnut

- Regulate water based on growth stages like pegging, flowering and pod development.
- Adopt the following schedule
 - Sowing or pre-sowing irrigation
 - Life irrigation 4-5 days after sowing
 - Irrigate 20 days after sowing
 - At flowering give two irrigations
 - At pegging give one or two irrigations
 - At pod development give 2 to 3 irrigations
- Spray 0.5% potassium chloride during flowering and pod development stage to mitigate the ill-effect of water stress.
- Adopt sprinkler irrigation method wherever possible.

3. Contingent plan for cotton

The following irrigation schedule can be adopted to overcome water stress.

- Irrigate immediately after sowing.
- Give life irrigation on 5th day of sowing.
- Irrigate on 20th and 35th day at vegetative phase.
- Irrigate copiously at 40, 50, 60, 70, 80 and 90 days after sowing which coincide with flowering and boll formation stages.
- Control irrigation during maturity phase from 100 to 150 days after sowing.
- Stop irrigation after 150th day.
- Adopt alternate furrow irrigation.
- Adopt drip irrigation method wherever possible.

4. Other management techniques

- Summer ploughing has to be done in large scale which is not only a water conservation method but also checks weed growth, facilitate easy puddling etc.
- Strengthening of field bunds to minimize the water loss through leakages and to impound rainwater to increase the infiltration and soil moisture storage.
- Adoption of drip or sprinkler irrigation methods wherever it is possible.
- Proper on-farm development works to reduce the water loss and in turn to increase the water application efficiency.
- Turn and rotational system of water supply can be introduced.

- Community system of nursery and mass mechanical ploughing can reduce water wastage.
- Introducing new cropping pattern for effective utilization of available water.
- Adoption of watershed method and in situ water conservation methods for efficient crop production.
- Farmers organization and participation appraisal are important extension activities which make the farmers to realize the value of water.

11.14 WATER MANAGEMENT IN PROBLEM SOILS

When rocks and minerals undergo weathering process, large quantities of soluble salts are formed. In humid regions, these salts are washed down to the ground water and to the sea. But in arid and semi-arid regions they accumulate in the soil. Excessive irrigation and poor water management are the two chief causes of water logging and salt accumulation. Accumulation of salts in soil leads to unfavourable soil-water-air relationship and affect the crop production.

A. Causes for Salt Accumulation

The following are the main causes which lead to development of salty soils (Salinity or alkalinity).

- Arid climate** - About 25% of earth surface is arid in which salt accumulation is a common problem. In India, about 25 m.ha are salt affected with different degrees of degradation.
- High subsoil water table** - When the water table is within the capillary range, the water containing soluble salts rises to surface. When the water evaporates the salts are deposited as encrustation. It is estimated that in Punjab, annually about 50,000 acres becomes saline because of raising water table.
- Poor drainage** - Due to poor drainage, accumulation of water leads to water logging condition, which leads to salt accumulation.

B. Quality of Irrigation Water

Irrigation water containing more than permissible quantities of soluble salts with sodium carbonate and bicarbonates make the soil salty.

Inundation with sea water - In coastal areas, periodical inundation of land by sea water during high tides makes soil salty. Besides, deep bore wells are also the reason for saline soils.

Nature of parent rock minerals - The saline nature of parent rock minerals leads to salt accumulation.

Seepage from canals - The continuous seepage leads to salt accumulation.

C. Classification of Problem Soils

The soil problems can also be divided into: (a) Chemical, (b) Physical.

(i) **Soil chemical problems** - The salt affected soils can be classified based on their ESP, pH and EC as follows:

	ESP (%)	EC (m.mhos/cm)	pH
Saline	< 15	> 4	< 8.5
Saline alkali	> 15	> 4	> 8.5
Alkali/sodic	> 15	< 4	> 8.5

Reclamation of saline soil - Leaching or flushing with good quality of water provided, there should be good drainage system should be there to flush water.

Reclamation of alkali soil - By converting exchangeable sodium into soluble salts by adding the following amendments.

- Calcium chloride
- Calcium sulphate (gypsum)
- Sulphuric acid
- Ferrous sulphate
- Aluminium sulphate

Reclamation of saline alkali soil - The reclamation of these soils is similar to that of alkali soils. First step is to remove the exchangeable sodium and then the excess salts and sodium are to be leached out. Commonly salt affected soils are referred as problem soils as indicated above. Further, based on pH value it can also be grouped as acid soils where the pH value is less than 7.

Management practice for chemical problems of soil - Reclamation of saline and alkali soils are not complete unless proper remedial measures are undertaken to restore the soil fertility and structure of the soil. The following are the important management practices to overcome these problems.

- The saline soil can be easily improved with leaching of salts by using of good quality water and by providing good drainage system.
- Application of gypsum would improve the permeability of soil by making good soil aggregates.
- In acidic soil, lime application should be adequate and excessive leaching should be avoided.
- Salt resistant or saline resistant species should be selected for cultivation.
- Application of amendments *viz.*, gypsum and press mud is found to suppress the sodium and chromium content in plant and soil.
- Growing resistant crops like ragi, cotton, barley and rice can be advocated.
- Growing green manure crops like sunnhemp, daincha and kolinji can be advocated.
- Growing resistant varieties like COC 771 in sugarcane and CO 43 in rice may be made.
- Adoption of drip irrigation for possible crops is also recommended to overcome soil physical and chemical problems.
- Liberal application of FYM.
- Application of green manure.
- Excess phosphorous application.
- Proper drainage to keep the soil without adverse effect to plant system.

(ii) **Soil physical problems** - Fluffy soils, ill drained soils, soils with high infiltration rate, soils with shallow depth and encrustation in soil surface are the possible physical problems. Too frequent irrigation in clayey soils with very high water retention results in poor drainage, water logging and crop damage. Excess irrigation and heavy rain create hardening of soil surface in red lateritic soils with high Fe and Al hydroxides and low organic matter. This results in soil crusting. This leads to poor germination, restriction of shoot and root development and slow entry of water into the soil profile.

Management - In light soils, shallow depth of water with more frequency should be adopted. To increase the infiltration rate in clay soil, amending the soil by mixing with coarse textured soil or tank silt at the rate of 50 tones per hectare is advocated. Organic wastes like crop residue, farm waste, coir pith, filter cake etc., at the rate of 20 tones per hectare once in every year can be applied. Poorly drained clay soils can be improved by providing tile drains and trenches intermittently. To make the soil more

permeable and to overcome poor drainage, addition of organic wastes or sandy soil at the rate of 20–50 tones per ha, respectively is advocated. The encrustation problem could be alleviated by incorporating organic matter and adding montmorillonite clay containing silt.

11.15 MANAGEMENT OF POOR QUALITY WATER FOR IRRIGATION

A. Quality of Irrigation Water

Whatever may be the source of irrigation water *viz.*, river, canal, tank, open well or tube well, some soluble salts are always dissolved in it. The main soluble constituents in water are Ca, Mg, Na and K as cations and chloride, sulphate, bicarbonate and carbonate as anions. However, ions of other elements such as lithium, silicon, bromine, iodine, copper, cobalt, fluorine, boron, titanium, vanadium, barium, arsenic, antimony, beryllium, chromium, manganese, lead, selenium, phosphate and organic matter are also present. Among the soluble constituents, calcium, sodium, sulphate, bicarbonate and boron are important in determining the quality of irrigation water and its suitability for irrigation purpose. However, other factors such as soil texture, permeability, drainage, types of crop etc., are equally important in determining the suitability of irrigation water. Following are the most common problems that result from using poor quality water.

Salinity - If the total quantity of salts in the irrigation water is high, the salts will accumulate in the crop root zone and affect the crop growth and yield. Excess salt condition reduces uptake of water due to high concentration of soil solution.

Permeability - Some specific salts reduce the rate of infiltration into the soil profile.

Toxicity - When certain constituents of water are taken up by plants, which accumulate in large quantities and result in toxicity and reduces yield.

Miscellaneous - Excessive Nitrogen in irrigation water causes excessive vegetative growth and leads to lodging and delayed crop maturity. White deposits on fruits or leaves may occur due to sprinkler irrigation with high bicarbonate water. Based on the characteristic features of majority of ground waters in use by the farmers in different agro-ecological regions of the country, the various indices which describe the nature of hazards on soils and crops, irrigation waters have been broadly grouped into good, saline and alkali waters. Depending on the degree of restrictions, the too poor quality waters have been further grouped into three homogenous sub groups as given in the Table 11.12.

Table 11.12. Groups of Poor Quality Ground Waters for irrigation

Water quality	<i>Ec</i> (ds/m)	<i>SAR</i> (m.mol/L)	<i>RSC</i> (me/L)
A. Good water	< 2	< 10	< 2.5
B. Saline water			
Marginally saline	2-4	< 10	< 2.5
Saline	> 4	< 10	< 2.5
High SAR Saline	> 4	> 10	< 2.5
C. Alkali water			
Marginally alkali	<4	< 10	2.5-4
Alkali	< 4	< 10	> 4
Highly alkali	Variable	> 10	> 4

Majority of natural ground waters have pH between 7.2 and 8.5 and are either in equilibrium or even super saturated in respect of calcite and dolomite. Water with pH less than 7.2 seems to be unsaturated in respect of calcite. Water samples with pH > 8.4 invariably have SAR more than 10. High pH is associated with waters containing residual alkalinity and a high carbonate: bicarbonate ratio. Water having residual alkalinity contains carbonate and bicarbonate ions in varying proportions depending on pH. The ratio of CO₃ ions in ground waters generally vary between 1:10 and 1:2, marginally saline waters have low SAR, the usual range being up to 20. Hardly 10-15 per cent of the total ground waters have both high SAR (>20) and high salinity. Based on some of the quality criteria like EC, pH, concentration of Na, Cl and SAR, suitability of irrigation water is classified into six grades.

Table 11.13. Classification of Irrigation Water Quality

<i>Quality of water</i>	<i>EC (m.mhos/cm)</i>	<i>pH</i>	<i>Na (ppm)</i>	<i>Cl (me./l)</i>	<i>SAR</i>
Excellent	0.5	6.5–7.5	30	2.5	1.0
Good	0.5–1.5	7.5–8.0	30–60	2.5–5.0	1.0–2.0
Fair	1.5–3.0	8.0–8.5	60–75	5.0–7.5	2.0–4.0
Poor	3.0–5.0	8.5–9.0	75–80	7.5–10	4.0–8.0
Very poor	5.0–6.0	9.0–10.0	80–90	10.0–12.5	8.0–15.0
Unsuitable	6.0	> 10	> 90	> 12.5	> 15

(SAR–Sodium Adsorption ratio)

B. Factors affecting suitability of water for irrigation

The suitability of particular water for irrigation is governed by the following factors.

- Chemical composition of water (TSS, pH, CO₃, HCO₃, Cl, SO₄, Ca, Mg, Na and B).
- Total concentration of soluble salts or salinity (EC).
- Concentration of sodium ions, in proportion to calcium and magnesium or sodicity (SAR).
- Trace element boron may be toxic to plant growth, if present in limits beyond permissible.
- The effect of salt on crop growth is of osmotic nature. If excessive quantities of soluble salts accumulate in the root zone the crop has extra difficulty in extracting enough water from salty solution, thereby affecting the yields adversely.
- Besides this, total salinity depends on the extent to which exchangeable sodium percentage (ESP) of soil increase as a result of adsorption of sodium from water. This increase depends on sodium percentage.
- Soil characteristics like structure, texture, organic matter, nature of clay minerals, topography etc.
- Plant characteristics like tolerance of plant varies with different stages of growth. The germination and seedling stages are usually more sensitive to salinity.
- Climatic factors can modify plant response to salinity. Tolerance to saline water irrigation is often greater in winter than in the summer. Rainfall is the most significant factor for the leaching of salts from the plant root zone. Temperature also plays a vital role.
- Management practices also play great role. Wherever saline water is used for irrigation, adoption of management practices which allow minimum salt accumulation in the root zone of the soil is necessary.

The primary parameters that have to be considered to ensure effective irrigation management for salt control are the water requirement of crop and quality of irrigation water. Correct irrigation should restore any soil water deficit to control salt levels.

C. Use of poor quality water

Besides the salinity and alkalinity hazard of water, some industrial effluents and sewage water are also problem waters that can be reused by proper treatment. The complex growth of industries and urbanization (Urban development) leads to massive increase in wastewater in the form of sewage and effluent. Waste water supplies not only nutrients but also some toxic elements such as total solids of chloride, carbonate, bicarbonate, sulphate, sodium, chromium, calcium, magnesium, etc., in high concentration. Besides this, the effluent or wastewater creates BOD (Biological Oxygen Demand). These wastewaters when used for irrigation lead to surface and sub surface source of pollution due to horizontal and vertical seepage.

Points to be considered

- Application of greater amounts of organic matter such as FYM, compost etc., to the soil to improve permeability and structure.
- Increasing the proportion of calcium, through addition of gypsum (CaSO_4) to the irrigation water in the channel, by keeping pebbles mixed gypsum bundles in the irrigation tank.
- Mixing of good quality water with poor water in proper proportions so that both the sources of water are effectively used to maximum advantage.
- Periodical application of organic matter and raising as well as incorporation of green manure crops in the soil.
- Irrigation the land with small quantities of water at frequent intervals instead of large quantity at a time.
- Application of fertilizer may be increased slightly more than the normally required and preferably ammonium sulphate for nitrogen, super phosphate and Di Ammonium Phosphate (DAP) for phosphorus application.
- Drainage facilities must be improved.
- Raising of salt tolerant crops such as cotton, ragi, sugar beet, rice, groundnut, sorghum, corn, sunflower, chillies, tobacco, onion, tomato, garden beans, amaranthus and lucerne.

Projected waste-water utilization - It is estimated that 2,87,000 million m^3 of waste water can be reusable. Hence, these waste waters can be properly treated as follows:

- Dilute with good quality water in the ratio of 50:50 or 75:25.
- Alternate irrigation with waste water and good quality water.
- Treat the effluent water through fill and draw tanks, lime tank, equalization tank, settling tank, sludge removal tank, aerobic and anaerobic treatment tanks etc.

11.16 DRAINAGE

For optimum growth and yield of field crops, proper balance between soil air and soil moisture is quite essential. Except rice many of the cultivated plants cannot withstand excess water in the soil. The ideal condition is that moisture and air occupy the pore spaces in equal proportions. When soil contains excess water than that can be accommodated in the pore spaces, it is said the field is water logged.

A. Causes of Water Logging

- Excessive use of water when the water is available in abundance or cheaply due to the belief that more water contributes better yield.
- Improper selection of irrigation methods.
- Percolation and seepage from lands, canals and reservoir located at nearby elevated places.
- Improper lay out, lack of outlets.
- Presence of impervious layer with profile impeding percolation.
- Upward rise of water from shallow ground water table or aquifer.

B. Effects of Water Logging

- (i) **Direct effects** - Replacement of soil air, which is the main source of oxygen for the roots as well as soil microbes. Due to high amount of CO₂ in soil air, high CO₂ concentration under waterlogged conditions will kill plant roots. Sometimes superficial root system or air space in root system will develop. Due to poor aeration, intake of water and nutrient will be reduced.
- (ii) **Indirect effects** - Nutrients are made unavailable due to leaching. Toxic elements will be formed under anaerobic conditions. Decomposition of organic matter under anaerobic condition results in production of organic acids like butyric acid, which is toxic to plants.
- Reduce the availability of N, Mn, Fe, Cu, Zn, Mo
 - Reduces soil temperature
 - Reduces the activity of beneficial microbes
 - Destruct soil structure
 - Difficult for cultural operation, and
 - Incidence of pest, disease and weeds.

Table 11.14. Changes for some Elements in Water Logged Condition

<i>Elements</i>	<i>Normal form</i>	<i>Reduced form in water logged soil</i>
Carbon	Carbon dioxide	Methane (CH ₄) complex aldehyde
Nitrogen	Nitrate (NO ₃)	Nitrogen (N) and NH ₂ amides, ammonia
Sulphur	Sulphate (SO ₄)	Hydrogen sulphide (H ₂ S)

C. Drainage – Meaning

It is the process of removal of excess water as free or gravitational water from the surface and the sub surface of farm lands with a view to avoid water logging and creates favourable soil conditions for optimum plant growth.

(i) Need

It is generally assumed that in arid region drainage is not necessary and water logging is not a problem. Even in arid region, due to over irrigation and seepage from reservoirs, canals etc., and drainage becomes necessary. Irrigation and drainage are complementary practices in arid region to have optimum soil water balance. In humid region, drainage is of greater necessity mainly due to heavy precipitation. Drainage is required under the following conditions.

- High water table.

- Water ponding on the surface for longer periods.
- Excessive soil moisture content above FC not draining easily as in clay soil.
- Areas of salinity and alkalinity where annual evaporation exceeds rainfall and capillary rise of ground water occurs.
- Humid region with continuous or intermittent heavy rainfall.
- Flat land with fine textured soil.
- Low lying flat areas surrounded by hills.

(ii) Characteristics of good drainage system

- It should be permanent.
- It must have adequate capacity to drain the area completely.
- There should be minimum interference with cultural operations.
- There should be minimum loss of cultivable area.
- It should intercept or collect water and remove it quickly within shorter period.

(iii) Methods of drainage

There are two methods; 1. surface method, and 2. sub surface method

1. **Surface drainage** - This is designed primarily to remove excess water from the surface of soil profile. This can be done by developing slope in the land so that excess water drains by gravity. It is suitable for:

- slowly permeable clay and shallow soil
- region of high intensity rainfall
- to fields where adequate outlets are not available
- the land with less than 1.5% slope.

It can be made by land smoothing and making field ditches. The surface drainage can be further classified as:

- Lift drainage
 - Gravity drainage
 - Field surface drainage
 - Ditch drainage
- (a) **Lift drainage** - To drain from low lying areas or areas having water due to embankment, lift drainage is used. Water to be drained is lifted normally by open devices, unscoops or by pumping or by mechanical means. This method is costly, cumbersome and time consuming.
 - (b) **Gravity drainage** - Water is allowed to drain from the areas under higher elevation to lower reaches through the regulated gravity flow through the outlet of various types. This system is practiced in wet land rice with gentle to moderate slopes. This method is less costly, easy and effective. However, the area to be drained should be leveled smooth and slightly elevated from the drainage source.
 - (c) **Field surface drainage** - The excess water received from the rain or irrigation is drained through this method. The irrigated basins or furrows are connected with the drainage under lower elevation, which is connected to the main out let and to the farm pond used for water harvesting. If the slope of the land is sufficient to drain excess water from the individual plot, this drain water

may be collected and stored locally in reservoir for recycling for life saving irrigation. This drainage method is cheap and effective but there is possibility of soil erosion and distribution of weed seeds along the flow of drainage water.

- (d) **Ditch drainage** - Ditches of different dimensions are constructed at distances to drain the excess water accumulated on the surface and inside the soil up to the depth of ditch. Such ditches may be interceptors or relief drains. This method is adopted in nurseries, seed beds and rainfed crops. This is an effective and efficient method but requires smoothening of surface and construction of ditches. This involves cost and wastage of crop lands. Shifting of soil, restriction for the movement of farm machineries, reconstruction and renovation of ditches during the crop duration and harvesting of crops are the problems in this method. In flat land, bed or parallel field ditches may be constructed. The collector ditches should be across the field ditches.

<i>Advantages</i>	<i>Disadvantages</i>
Low initial cost	Low efficiency
Easy for inspection	Loss of cultivable land
	Interference to cultural operation
	High maintenance cost
Effective in low permeability areas	

2. **Sub surface drainage system** - Sub surface drains are underground artificial channels through which excess water may flow to a suitable outlet. The purpose is to lower the ground water level below the root zone of the crop. The movement of water into subsurface drains is influenced by the hydraulic conductivity of soil, depth of drain below ground surface and the horizontal distance between individual drains. Underground drainage is mostly needed to the medium textured soil, high value crops and high soil productivity. There are four types of sub surface drainage.

- Tile drainage
- Mole drainage
- Vertical drainage
- Well Drainage/or Drainage wells.

Advantages

- There is no loss of cultivable land
- No interference for field operation
- Maintenance cost is less
- Effectively drains sub soil and creates better soil environments.

Disadvantages

- Initial cost is high
- It requires constant attention
- It is effective for soils having low permeability.

1. **Tile drainage** - This consists of continuous line of tiles laid at a specific depth and grade so that the excess water enters through the tiles and flow out by gravity. Laterals collect water from soil

and drain into sub main and then to main and finally to the out let. The drains are made with clay and concrete. Tiles should be strong enough to withstand the pressure and also resistant to erosive action of chemicals in soil water.

2. **Mole drainage** - Mole drains are unlined circular earthen channels formed within the soil by a mole plough. The mole plough has a long blade like shank to which a cylindrical bullet nosed plug is attached, known as mole. As the plough is drawn through the soil, the mole forms the cavity to a set depth. Mole drainage is not effective in the loose soil since the channels produced by the mole will collapse. This is also not suitable for heavy plastic soil where mole seals the soil to the movement of water.
3. **Vertical drainage** - Vertical drainage is the disposal of drainage water through well into porous layers of earth. Such a layer must be capable of taking large volume of water rapidly. Such layers are found in river-beds.
4. **Drainage wells** - The wells are used for the drainage of agricultural lands especially in irrigated areas.

D. Systems of Drainage

There are four systems of drainage:

1. **Random** - This is used where the wet areas are scattered and isolated from each other. The lines are laid more or less at random to drain these wet areas. The main is located in the largest natural depression while the sub mains and laterals extend to the individual wet areas.
2. **Herringbone** - In this system, the mains are in a narrow depression and the laterals enter the main from both sides at an angle of 45° like the bones of a fish.
3. **Gridiron** - The gridiron is similar to herringbone but the laterals enter the main only from one side at right angles. It is adopted in flat regularly shaped fields. This is an efficient drainage system.
4. **Interceptor** - Ditches of different dimensions are constructed at distances to drain the excess water accumulated on the surface and inside the soil up to the depth of ditch. Such ditches may be interceptors or relief drains. This method is adopted in nurseries, seedbeds and rainfed crops. This is an effective and efficient method but requires smoothening of surface and construction of soil. Restriction for the movement of farm machineries, reconstruction and renovation of ditches during the crop duration and harvesting of crops are the problems in this method. In flat land, bed or parallel field ditches may be constructed. The collector ditches should be across the field ditches.

11.17 IRRIGATION MANAGEMENT IN COMMAND AREAS

A. Irrigation Management

Irrigation management (water management) encompasses the process of storage, diversion, conveyance, regulation, measurement, distribution, application of the optimum quantity to crop and removal of excess water from the root zone as drainage. In Indian states and in Tamil Nadu, most of the irrigation projects aim at to meet the need of crop production and power generation. In countries like USA, irrigation management planning includes water for recreation and environmental stability besides power generation and crop production.

B. River Command Areas

- (a) *Vastness* - Irrigation management involves large land areas which may cover few sovereign

(independent) countries, few states within a country or few districts within a province (state). River Colorado of South-west of USA flows through seven auto states within USA (Wyoming, Utah, Colorado, Arizona, New Mexico, Nevada, California) and Mexico, another nation. River Cauvery originates in Coorg of Karnataka state and irrigates Karnataka, Tamil Nadu and Pondicherry states. Altogether Karnataka, Kerala, Tamil Nadu and Pondicherry states are involved in Cauvery river system. Usually many river systems are bigger in size (Ganges, Indus, Zambasi). Some of the river projects are meant only for power generation (Zambasi of Zambia and Zimbava). In India, most of the projects are for power generation and irrigation purposes. In big river projects navigation (Ganges) also takes place.

River commands are complex and complicated due to geographical, political and socio-economic scenario peculiar to every project. Hydro-politics (disputes) is a part of the river commands between provinces and countries. Cauvery command of Tamil Nadu is unique for historical social, political and economic reasons. During B.C. 1st Century (speculation up to A.D. 2nd century), King Karikala cholan built the Grand Anaicut to divert flood water to Cauvery by putting stone embankments in Coleron (Kollidam). This is considered to be the major accomplishment in water management at that time. The Cauvery system emanates from Kudagu, travels a distance of about 430 km before reaching Bay of Bengal. It is a very well developed delta at the coramandal coast (Cholamandalam coast) in the Tanjavur district of Tamil Nadu. Out of the total flow of Cauvery the following are the contributions from different states.

Karnataka	–	52.5 per cent
Tamil Nadu	–	39.3 per cent
Kerala	–	8.2 per cent
Total	–	100.0 per cent
	–	Irrigated area in Karnataka, 2.72 lakh ha
	–	Irrigated area in Tamil Nadu 11.28 lakh ha

In Cauvery delta,

River courses and branches	:	36 Nos.
Total length of above courses	:	1000 Miles
Canals created	:	30000 Nos.
Total length of channels	:	15000 Miles
A class channels	:	1500 Nos.
B class channels	:	9750 Nos.
C class channels	:	110000 Nos.
D class channels	:	53000 Nos.

Government maintains 36 river courses and branches and 138 A class channels and rest are maintained by the farmers. Cauvery system was once a system of sufficiency and now become a system of deficiency. The main crops grown are Rice, Banana, Sugarcane, Vegetables, Coconut and Sylvianagronomy crops (tree crops in fields). There are also trans-basin systems like Periyar-Vaigai of Tamil Nadu. West flowing Periyar river in the Western Ghats has been diverted to Tamil Nadu in opposite direction through tunnels. It was accomplished in 1896 by the Royal Engineer Pennquik. This is an unique project in Tamil Nadu of India in which modernization has been taken up.

(b) *Need for modernization of river commands* - In order to increase the efficiency of the existing system to reduce water losses and to bring additional area under irrigation, earthen channels were lined with cement concrete on both bottom and sides. Granite stone masonry was also adopted for field

watercourses. After modernization of main canal and branch channels, efficiency of the water conveyance has increased from 45–75 per cent.

C. Water Release and Water Distribution

Water release is usually followed based on operational manuals and established procedures. Water release procedures were evolved based on historical and other considerations based on priorities and water availability.

- Optimum water supply
- Equity between big and small farmers
- Locational equity (Head, reach, middle reach and tail end farmers)
- Environmental stability
- Less scope for malpractices.
- Water distribution methods

1. Flexible methods

- On demand
- Modified demand method
- Continuous flow method (Rice growing systems)

2. Rigid method

- Constant frequency – Constant amount
- Constant frequency – Varied amount
- Variable frequency – constant amount
- Variable frequency – variable amount

3. General methods followed

- Warabandhi of western India (Rigid system of constant frequency of constant amount).
- Shejpali system of Maharashtra (Irrigation from the end at fixed intervals).
- Ozarabandhi in Uttar Pradesh (Alternate sluices draw water at a time).
- Continuous flow (during sufficiency for rice, banana, sugarcane) and turn system of Tamil Nadu (Scarcity, variable frequency and variable quantity).

Irrigation system maintenance and operation involves co-operation of the irrigation department, agricultural engineering department, agricultural department, co-operative department and farmers. Farmers are the ultimate users of water. In fact many international, national and state agencies are involved in the form of funding technical input, technical training of different officials and farmers. Policy issues are also playing key role which need political, administrative and social will at different levels.

11.18 IRRIGATION MANAGEMENT UNDER LIMITED WATER SUPPLY

As any scarce resource needs management for its optimal utility, the irrigation water also needs management to obtain optimum crop production with the available water resources. Water management is practiced in two stages *viz.*, 1. Water distribution management, and 2. Water utilization management. The later is the crop water management at field level.

Rotational water supply (RWS)

RWS is one of the techniques in irrigation water distribution management. It aims at equidistribution of irrigation water irrespective of location of the land in the command area by enforcing irrigation time schedules. Each 10 ha block is divided into 3–4 sub units (irrigation groups). According to the availability of irrigation water, stabilized field channels and group-wise irrigation requirement, time schedules are evolved. The irrigation will be done strictly in accordance with the group-wise time schedules by the block committees. Within the group, the time is to be shared by the farmers within the group by themselves.

11.19 WATER RELATIONS OF SOIL

The mineral and organic compounds of soil form a solid (though not rigid) *matrix*, the interstices of which consists of irregularly shaped pores with a geometry defined by the boundaries of the matrix. The pore space, in general, is filled partly with soil air and liquid vapour and partly with the liquid phase of soil water. Soil moisture is one of the most important ingredients of the soil. It is also one of its most dynamic properties. Water affects intensely many physical and chemical reactions of the soil as well as plant growth. The properties of water can be explained by the structure of its molecule. Two atoms of hydrogen and one atom of oxygen combine to form a mole largely determined by that of the oxygen ion. The two hydrogen ions take up practically no space. Water molecules do not exist individually. The hydrogen in the water serves as a connecting link from one molecule to the other. Soil serves as the storage reservoir for water. Only the water stored in the root zone of a crop can be utilized by it for its transpiration and buildup of plant tissues. When ample water is in the root zone, plants can obtain their daily water requirements for proper growth and development. As the plants continue to use water, the available supply diminishes, and unless more water is added, the plants stop growing and finally die. Before the stage is reached when crop growth is adversely affected, it is necessary to irrigate again. The amount of water to be applied to each irrigation, and the frequency of irrigation are dependent on the properties of the soil and the crop to be irrigated.

11.20 MOVEMENT OF WATER INTO SOILS

Immediately after irrigation or rainfall, the first action or process of water intake is called infiltration, then percolation and then seepage take place. The movement of water from the surface into the soil is called *infiltration*. The infiltration characteristics of the soil are one of the dominant variables influencing irrigation. *Infiltration rate* is the soil characteristic determining the maximum rate at which water can enter the soil under specific conditions, including the presence of excess water. It has the dimensions of velocity. The actual rate at which water is entering the soil at any given time is termed the *Infiltration velocity*. The infiltration rate decreases during irrigation. The rate of decrease is rapid initially and the infiltration rate tends to approach a constant value. The nearly constant rate that develops after some time has elapsed from the start of irrigation is called the *basic infiltration rate*.

Factors affecting infiltration rate - The major factors affecting the infiltration of water into the soil are the initial moisture content, condition of the soil surface, hydraulic conductivity of the soil profile, texture, porosity, and degree of swelling of soil colloids and organic matter, vegetative cover, duration of irrigation or rainfall and viscosity of water. The antecedent soil moisture content has considerable influence on the initial rate and total amount of infiltration, both decreasing as the soil moisture content rises. The infiltration rate of any soil is limited by any restraint to the flow of water

into and through the soil profile. The soil layer with the lowest permeability, either at the surface or below it, usually determines the infiltration rate. Infiltration rates are also affected by the porosity of the soil, which is changed by cultivation or compaction. Cultivation influences the infiltration rate by increasing the porosity of the surface soil and breaking up the surface seals. The effect of tillage on infiltration usually lasts only until the soil settles back to its former condition of bulk density because of subsequent irrigations.

Infiltration rates are generally lower in soils of heavy texture than on soils of light texture. The influence of water depth over soil on infiltration rate was investigated by many workers. It has been established that in surface irrigation, increased depth increases initial infiltration slightly but the head has negligible effect after prolonged irrigation. Infiltration rates are also influenced by the vegetal cover. Infiltration rate on grassland is substantially higher than bare uncultivated land. Additions of organic matter increase infiltration rate substantially. The hydraulic conductivity of the soil profile often change during infiltration, not only because of increasing moisture content, but also because of the puddling of the surface caused by reorientation of surface particles and washing of finger materials into the soil. Viscosity of water influences infiltration. The high rate of infiltration in the tropics under otherwise comparable soil conditions is due to the low viscosity of warm water.

11.20.1 Water Movement in Soil Profile

Normally water will move from higher potential to lower potential area in soil profile. Generally the water movement within the soil profile takes place under three conditions.

- Water moves through the water filled pore spaces due to gravity and Hydraulic conductivity or it can also be termed as water movement under saturated condition, *i.e.*, when soil pore spaces are completely filled with water.
- Film of water surrounding the soil particles moves due to the force of surface tension under unsaturated condition or it can be stated as capillary water movement along the potential gradient.
- Water also diffuses as water vapour through the air filled pore spaces along the gradient of decreasing vapour pressure.

Water movement in saturated conditions - Saturated flow occurs when water is in zero or smaller tension or at free water conditions. In this situation, all or most of the pore spaces are completely filled with water and the water moves downwards due to gravitational force. This saturated flow decreases as the soil pore space size decreases *i.e.*, the saturated flow is high in coarse textured soil than fine textured soil. Generally the rate of flow of various texture soils is in the following sequence.

Sand > loam > clay

The theory of water movement in the soil is based on Darcy's law or generalized form of Darcy's law.

Darcy's law - It states that the quantity (volume) of water passing through an unit cross-section of soil is proportional to the gradient of hydraulic head or hydraulic gradient.

Hydraulic gradient - It is the rate of change in hydraulic head with distance.

$$Hg = \frac{\text{Difference in hydraulic head}}{\text{Distance}} \quad \text{i.e., } I = \frac{h}{d}$$

where , Hg = Hydraulic gradient = *I*

Generally, Darcy's law is used to compute the velocity of flow of water through soil by using the formula.

$$V = k \frac{h}{d} = ki$$

Where,

V	=	velocity in cubic centimeter/second/centimeter
h	=	hydraulic head in centimeters
d	=	flow length or distance in centimeters.
k	=	hydraulic conductivity or proportionality constant

This formula can also be written as

	V	=	ki , (since $h/d = I$)
Where,	V	=	effective flow velocity
	k	=	hydraulic conductivity
	i	=	hydraulic gradient.

Here, the value of ' k ' depends upon the properties of fluid as well and those of soil. In mathematical expression Darcy's law can be written as

$$q = kia$$

Where,

q	=	volume of flow per unit time (cm ³ /sec)
i	=	hydraulic gradient (dimensionless)
a	=	cross-section of flow area (cm ²)
k	=	hydraulic conductivity (cm/sec)

11.20.2 Water Movement in Unsaturated Condition

The unsaturated soil water movement is also called as capillary movement. In this condition the macro pores are filled with air and only micro pores are filled with water which is held relatively more tightly and water is able to move very slowly. When soil moisture decreases, a part of pore spaces is occupied by soil air and the cross-sectional area for water movement is reduced and three by hydraulic conductivity becomes low. In unsaturated conditions, the conductivity is more in fine soil than coarse textured soil. Hence, the unsaturated hydraulic conductivity is the function of soil moisture content, number, size and continuity of soil pores etc. The rate of unsaturated flow in various soil texture is in the following order.

$$\text{Sand} < \text{loam} < \text{clay}$$

11.21 WATER VAPOUR MOVEMENT

It takes place within the soil as well as between soil and atmosphere under dry range. The vaporization under wet range is not taken into account in irrigation practices as it is in negligible range. The finer the soil pores higher is the moisture tension under which maximum water vapour occurs. In the coarse textured soil, at low tension the soil pores become free of liquid water when soil dries out. There is little moisture left for vapour transfer. But fine textured soil retains substantial amount of moisture even at high tensions thus permitting vapour movement in soil occurs before it reaches PWP (Permanent Wilting Point). In this situation water vapour movement contribution is considered for the survival of plants. Distribution of water in sandy loam and clay loam type of soil is given in figure. In coarse textured sandy loam soil the water distribution is very narrow and it percolates down to 180 cm within

24 hours of time period. At the same time horizontally the water spread to the maximum of 30 cm width. But in clay soil, the water percolates down to a depth of 90-120 cm after 24 hours of irrigation. The water distribution is to a width of more than 60. cm horizontally during the same period. The figure clearly indicates that in finer texture soil, water movement is slow vertically and spread horizontally more than coarse textured soil.

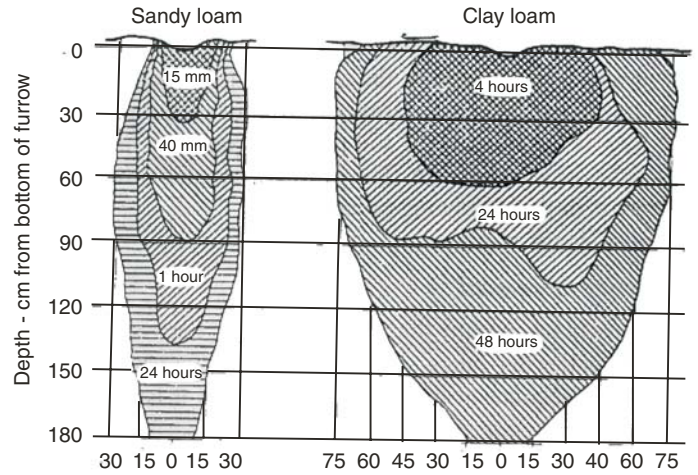

Fig. 11.17 Distance-cm from centre of furrow

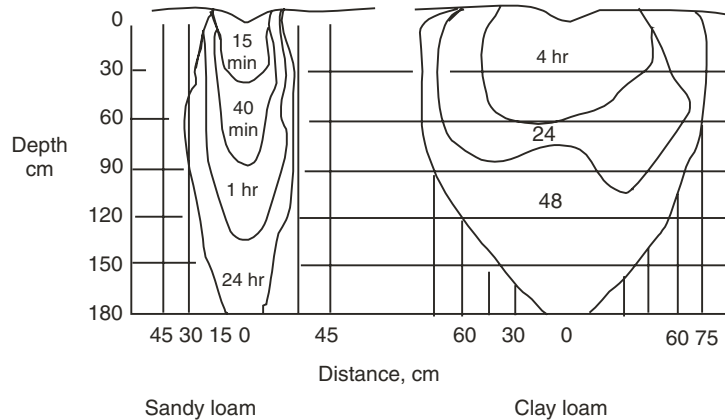

Fig. 11.18 Soil moisture distribution in clay loam and sandy loam soil

11.22 SOIL MOISTURE CONSTANTS

Soil moisture constant is nothing but the status of the soil mass or changes occurring in the soil mass after the irrigation or rainfall. In real sense we cannot expect constants of soil moisture, since it is very dynamic and always tends to change due to potential gradient or pressure gradient. These phenomenon helps to find out the soil moisture status, the availability condition of soil moisture, time and quantity of irrigation water to be applied etc. The soil moisture constants are:

- Saturation or Maximum water holding capacity (MWHC)
- Field capacity (FC)
- Permanent wilting point (PWP)
- Available soil moisture (ASM)
- Moisture equivalent
- Hygroscopic coefficient.

11.22.1 Saturation

Immediately after surface irrigation or heavy downpour (or) good amount of rainfall, soil below the surface are completely filled up with water. At this stage, all the micro and macro pores are filled with water. This condition is said to be the saturation point or maximum water holding capacity of soil. In saturation point, water is held without any force or tension or the tension is almost zero. This is equal to free water surface. At this point, the gravitational force tends to pull some water or part of water, which moves downwards due to gravitational force. This water is known as gravitational water or free water.

11.22.2 Field Capacity

This can be defined as the moisture content present in the soil after the drainage of water due to gravitational force is stopped or ceased or become very slow. Hence, it can also be stated as the moisture content retained against the gravitational force. It can also be defined as the moisture present in the micro pore or capillary pore, which cannot be drained off due to gravity. At this point, the moisture content in the soil is comparatively stable and each soil particle is completely surrounded with thick film of water. Hence, it is also known as capillary water. This soil moisture is held with some force or tension against the gravitational force. The force with which water is held is measured in terms of moisture tension. Normally it ranges from 1/10 atmosphere to 1/3 atmosphere for coarse and fine textured soils, respectively.

The field capacity is the upper limit of available water to plants or maximum water available point to the plants. Hence, it is also known as Full point. The field capacity of soil is influenced by the soil texture or size of the particles, structure and amount of water applied. Immediately after irrigation or rainfall soil will reach saturation and its field capacity after two or three days depending upon the soil texture. The time required to reach field capacity condition is increased if soils are fine textured and rich in organic matter, which restricts the downward movement of water.

11.22.3 Permanent Wilting Point

It is the condition of soil moisture at which plant cannot extract water from soil due to its high tension. It is the soil moisture condition at which water is held so tightly by the soil particles and this water cannot be removed by the plant roots. The plants wilting cannot be changed by further addition of water (or) the plant cannot regain its turgidity even though water is made available to the plants. This condition is called permanent wilting point. At this point, soil moisture tension will reach very high *i.e.*, the moisture held in soil particles with a tension of about 14 to 15 atmospheres. Wilting and drooping of leaves are the most common symptoms at PWP. Some highly drought resistant crops will not wilt but show the symptoms like stunted plant growth, drooping of leaves, change in appearance and leaf colour, drooping of flowers, fruits etc.

11.22.4 Available Soil Moisture

This is the moisture content between the FC and the PWP level. After reaching PWP, the plant roots

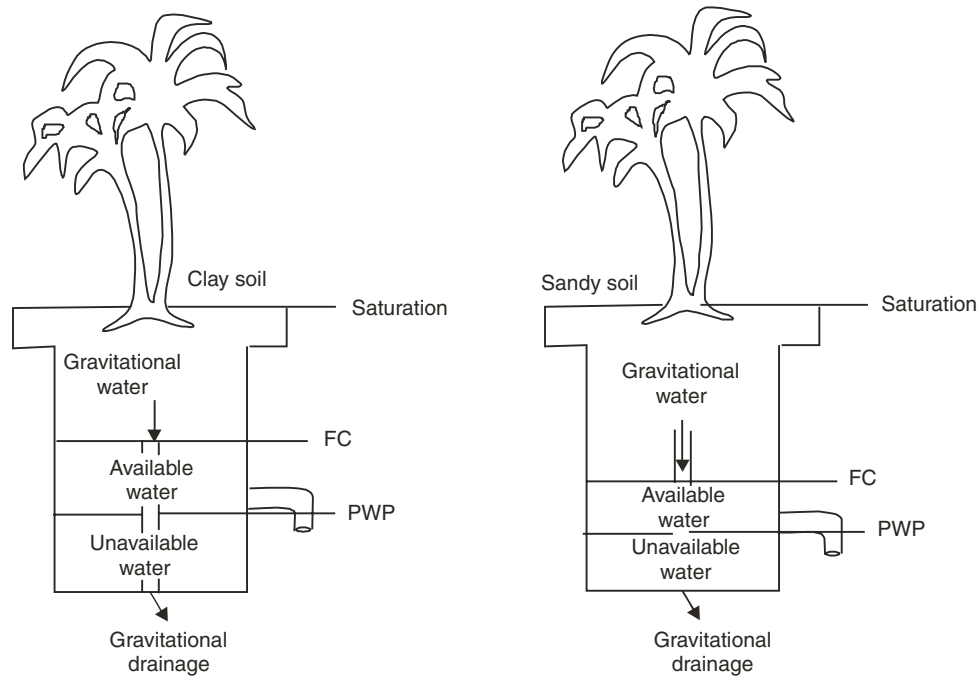

Fig. 11.19 Soil moisture constants

cannot extract water. It can be defined as the water available in the capillary pores after the cessation of gravitational movement of water and up to the limit of permanent wilting point. This available soil moisture is not only the function of soil physical properties like texture and structure but also the soil depth. Hence, it is expressed in terms of depth dimension for the particular root zone depth and described as:

$$ASM = \frac{FC - PWP}{100} \times bd \times d$$

Where, ASM = Available soil moisture in root zone
 FC = field capacity %
 PWP = permanent wilting point %
 bd = bulk density of soil (g/cc)
 d = depth of root zone in cm.

In layered soil or at different depths the water storage capacity or available water capacity (AWC) is computed as the summation of capacity of different layers comprising the root zone as below.

$$AWC = \sum_{i=1}^n \frac{(FC - PWP)}{100} \times bdi \times di$$

Where, i = i^{th} layer
 di = denotes depth of i^{th} layer
 bdi = bulk density of the i^{th} layer
 n = denotes the number of soil layers

Field capacity and PWP are not fixed points but represents a range because water is always dynamic in soil. Hence, this available soil water is influenced by Agro-climatic functions and soil factors.

11.22.5 Moisture Equivalent

It is defined as the amount of water retained by the saturated soil sample after being centrifuged for 1000 times that of the gravitational force for definite period of time usually for half an hour. A small mass of soil sample is saturated with water and the same is subjected to centrifugal force of 1000 times that of gravitational force for half an hour and the soil moisture percentage is worked out by gravimetric method. This moisture percentage is equal to field capacity. In light textured sandy soil it is less than FC, whereas in heavy textured clay soil it is more than FC.

Hygroscopic coefficient - It is the lower limit of soil moisture or very thin film of soil moisture around the soil particles. Simply it is expressed as the percentage of moisture in air-dry soil *i.e.*, the moisture that remain in the soil after drying in air. At this point the moisture is held very tightly with soil particles with a tension of 10,000 atmosphere to 33 atmosphere. Hence, this water cannot be absorbed by the plants since, plant cannot exert this much of tension or force to remove the water. Hence, it is said to be the unavailable water. This water can be removed from soil particles by drying them in an oven at 105°C.

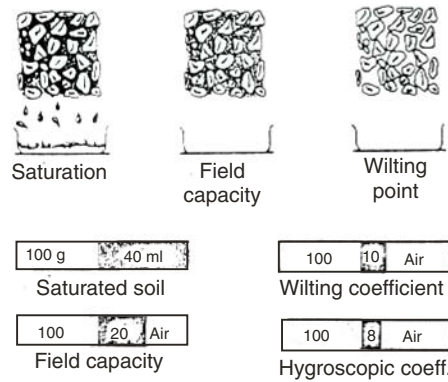

Fig. 11.20 Soil moisture constants

11.22.6 Hydraulic Conductivity

Hydraulic conductivity is the permeability of soil pores to the water movement under submerged condition. Hydraulic conductivity can be expressed as the proportionality factor of fluid properties (like its velocity, viscosity) and soil properties (such as infiltration, percolation and seepage) and soil influenced by soil structure and texture for water movement in soil profile. Simply it can be defined as the effective flow velocity at unit hydraulic gradient at saturated conditions and has the dimension of velocity. It is the ratio of flow velocity to the driving force of the soil solution or viscous flow under saturated condition.

$$H.C. = K \frac{\text{Flow velocity (V)}}{\text{Driving force of viscous flow (i)}}$$

(Here Driving force of viscous flow is nothing but the Hydraulic gradient (i))

(K = Proportionality constant in Darcy's law)

Therefore, $V = Ki$.

11.23 ESTIMATION OF SOIL MOISTURE CONSTANTS

1. **Water holding capacity** - Water holding capacity is estimated with Keen and Razowaski cup. The soil is paced in this cup after fitting a filter paper at the bottom. Soil is soaked by capillary action. Weight is taken immediately after wiping the water on the sides of the cup and moisture is computed on oven dry basis.
2. **Field capacity** - Field capacity is estimated directly in the field by ponding water in the plot covered all round by a bund. The test area may be 2 m². After a copious rain or heavy irrigation, estimation may be taken up. Soil is allowed to drain the excess water. Surface is covered to prevent evaporation. This may be accomplished by spreading a polythene sheet or thick straw mulch on the ground surface. Soil sampling is to be done at 24, 36, 48 and 72 hours. Soil moisture content is estimated by gravimetric method after drying in an oven at 105°C for 6–9 hours till concordant weights are obtained. Moisture curves are to be drawn to locate the relatively stable values against time. For all soils except heavy clay soil, the sampling time may be 48 hours from irrigation. For experimental fields, field capacity may be estimated for few layers (0–15, 16–30, 30–45 and 45–60 cm) depending upon the rooting depth and information to be generated. Field capacity is also estimated with pressure plate apparatus by maintaining 1/3 atmosphere in disturbed soil sample.
3. **Moisture equivalent** - Moisture equivalent is estimated in the disturbed and air-dried soil sample. The soil is passed through 2.0 mm sieve. A porcelain buchner funnel of 5 × 2 cm is taken. A filter paper is slightly wet to enable to stick on the bottom. Air-dry soil is added to the funnel with gentle tapping against a smooth surface to ensure uniform packing. Soil is added to the full capacity of the buckner funnel and cut of the surface with the spatula. Soil sample in the funnel is left into water to enable the water to move by capillary action through the stem of the funnel. Soil in the funnel is left for 24 hours to be in equilibrium with water through capillary movement. After 24 hours, the funnel is removed from water column and fitted to a filter flask. The filter flask is connected to a vacuum pump (550 rpm) and subjected to suction for 15 minutes. During the process of suction, the soil is put into an aluminum cup without filter paper and moisture content is estimated by oven dry method.
4. **Wilting point** - Estimation of wilting point moisture involves growing of sunflower as indicator plant in tin can. The tin can is closed with lid and the plant is allowed to grow through an opening in the lid. The plant is watered to grow for three to four weeks till three to four leaves develop. The plant is watered last and the space in the lid around the stem of the plant is plugged with cotton to control evaporation. The plant in the tin is allowed to wilt gradually. When the plant shows signs of loss of turgor, the can with plant is transferred to a dark humid cabinet to create high humidity. To reduce transpiration the humid cabinet is covered with a black polythene sheet. Inner sides of the cabinet are lined with gunny to retain moisture. The plant is allowed to extract moisture form the soil. If the plant is gaining turgidity, it is exposed to atmosphere for two hours and then transferred to humid cabinet. This process is repeated till the plant does not recover in the humid cabinet. At the stage the moisture content of the soil in the can is estimated to find out the wilting point of the soil.
5. **Use of pressure plate apparatus for estimating soil moisture constants** - Soil moisture content values may be obtained by the use of pressure plate apparatus or pressure membrane apparatus. The soil in test is placed in this layer in the cups of the pressure membrane apparatus. Desired pressure is applied to obtain the required soil moisture constant (FC 1/3 atm) and the moisture content of the soil sample is estimated.

11.24 MOISTURE EXTRACTION PATTERN OF CROPS

Plant absorbs moisture from soil through their root system. The method and quantity of water absorption varies with crops and their rooting pattern. The moisture extraction pattern reveals about how the moisture is extracted and how much quantity is extracted at different depth level in the root zone. The moisture extraction pattern shows the relative amount of moisture extracted from different depths within the crop root zone. The moisture extraction pattern of plant growing in a uniform soil without a restrictive layer and with adequate supply of available soil moisture throughout the zone is shown in Figure. It is seen from the following figure that about 40% of the total moisture is extracted from the first quarter of the root zone, 30% from second quarter, 20% from the third quarter and 10% from last fourth quarter. This indicates that in most of the crops the effective root zone will be available in the 1st quarter and it does not mean that the last quarter will not need any water. Hence, soil moisture measurements at different depths in the root zone have to be taken.

- to estimate the soil moisture status, and
- to work out the irrigation quantity to be applied.

A. Rooting Characteristics and Moisture Extraction Pattern

The root system is extremely variable in different crop plants. The variability exists in rooting depth, root length and horizontal distribution of roots. These are further influenced by environmental factors and the genetic constitution. The roots of cereals apparently occupy more surface area of the soil than other crops. For example, it has been proved that cereals' roots extend to 200–400 cm of soil surface area as against 15–200 cm/m² for most graminaceous plants. The amount of soil moisture that is available to the plant is determined by the moisture characteristics of the soil depth and the density of the roots. The moisture characteristics of soil like FC and PWP cannot be altered so easily and greater possibilities lie in changing the rooting characteristics of plants system to go deeper and denser and more proliferation to tap water from deeper layer of soil as well as from the larger surface area. Plants vary genetically in their rooting characteristics. (Figures) vegetable crops like onion, potato, carrot etc., have very sparse rooting system and unable to use all the soil water in the root.

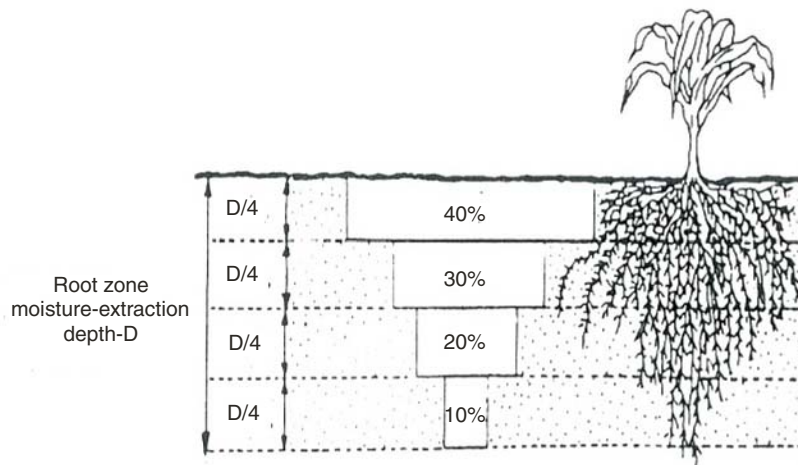

Fig. 11.21 Moisture extraction pattern

Rice, grasses, sorghum, maize, sugarcane have very fibrous dense root system, which can extract much water from soil. Millets, groundnut, grams are moderately deep rooted. Maize, sorghum, lucerne, cotton and other perennial plants have deep root system and can utilize effectively the moisture stored in root zone as well as in the unexploited deeper zones. Crops, which have dense and deep root system, like cotton, sorghum and red gram tolerate high reduction of soil water content. Shallow rooted crops like rice, potato, tomato tolerate low level of soil water reduction. Moderately deep-rooted crops like millets, groundnut, and grams tolerate medium level of soil water reduction.

Rootzone moisture extraction pattern - The root growth of the crop plants is affected by genetic nature, high water table, shallow nature of soil and permeability of soil layer, soil fertility and salt status of soil.

B. Effective Root Zone Depth

It is the depth in which active root proliferation occurs and where maximum water absorption is taking place. It is not necessary that entire root depth should be effective.

Table 11.16. Effective Root Zone Depth of some Common Crops

<i>Shallow (60 cm)</i>	<i>Medium to deep (90 cm)</i>	<i>Deep (120 cm)</i>	<i>Very deep (180 cm)</i>
Rice	Wheat	Maize	Sugarcane
Potato	Ground nut	Cotton	Citrus
Cauliflower	Carrots	Sorghum	Coffee
Cabbage	Soybean	Pear millet	Sunflower
Lettuce	Pea	Sugar beet	
Onion	Bean	Chillies	

11.25 WATER MOVEMENT IN SOIL-PLANT-ATMOSPHERIC SYSTEM

The total quantity of water required for the essential physiological functions of the plant is usually less than 5 per cent of all the water absorbed. Most of the water entering the plant is lost in transpiration. But failure to replace the water loss by transpiration results in the loss of turgidity, cessation of growth and death of plants due to dehydration.

The following are the main areas of water movement in plant system:

- Water absorption
- Water adsorption
- Water conduction and translocation
- Water loss on transpiration

The path of water movement may be divided into four sequential processes as follows:

- The supply of liquid to root surface-Adsorption
- The entry of water into the root-Absorption
- The passage of water in the conducting tissues-(Xylem) Translocation or conduction.
- Movement of water through and out of leaves-Transpiration or loss of water.

The rate of water movement is directly proportional to potential gradient *i.e.*, higher potential to lower potential and inversely proportional to the resistance to flow.

A. Mechanism of Water Absorption

In plants, water is absorbed through root hairs, which are in contact with soil water. The wall of the root hairs are permeable and consists of pectic and cellulose substances which are strongly hydrophilic (water loving) in nature. There are two types of absorption *viz.*, (a) Active absorption, and (b) Passive absorption.

(a) **Active absorption** - Here the process of osmosis plays an important role. The soil plant water movement can be effected due to forces of imbibition, diffusion and osmosis.

Significance of Osmosis

- Large quantities of water are absorbed by roots from soil by osmosis.
- Cell to cell movement of water and other substances takes place through this process.
- Opening and closing of stomata depends upon the turgor pressure of guard cells.
- Due to osmosis the turgidity is maintained and give a shape to the plants.

(b) **Passive absorption** - It is mainly due to transpiration and the root cells do not play active role. Passive absorption takes place when rate of transpiration is very high. Rapid evaporation from the leaves during transpiration creates a tension in water in the xylem of the leaves. These tension is transmitted to the water in xylem of roots through the xylem of stem. Due to this, water rises upward to reach the transpiring surface. As a result, soil water enters into the cortical cells through the root hairs to reach xylem of the roots to maintain the supply of water. The force for this entry of water is created in leaves due to rapid transpiration and hence the root cells remain passive during this process. It is otherwise known as transpiration pull.

B. Factors Affecting Absorption of Water

- (i) **Available soil water** - Capillary water is available to plants. Hygroscopic water and gravitational water are not available to plants. The capillary water is absorbed by the plants, which in turn reduces the soil water potential. Hence, the water from higher potential area tends to move to lower potential area and root will absorb this water. This is the chain of process involved in water uptake.
- (ii) **Concentration of soil solutions** - High concentration affects the process of osmosis.
- (iii) **Soil air** - Sufficient amount of O² should be there and excess amount of CO₂ affects the availability of water by root suffocation.
- (iv) **Soil temperature** - Up to 30°C favours absorption. Very low and very high temperature affects absorption.
- (v) **Soil texture**
 - Clay – Neither good nor bad
 - Sand – Not good for absorption
 - Loamy – Good for absorption

C. Crop Response to Irrigation and Fertilizers

The requirement regarding the number and their timings vary widely for different crops. It has been observed that water requirement of crops vary with the stages of its growth. When the water supply is

limited, it is necessary to take into account the critical stages of crop growth with respect to moisture. The critical stages of crop growth is commonly used to define the stage of growth. Certain critical stages at which if there is shortage of moisture, yield is reduced drastically. When there is shortage of water, it is better to take care of the critical stages first to obtain increased water use efficiency.

(i) **Water and fertilizer** - Water is the key factor in all the three mechanisms (mass flow, diffusion, transpiration pull) of nutrient uptake. Root intercepts more nutrient ions when growing in a moist soil than dry soil. In moist soil, the effective root zone area will be more and extensive which in turn absorbs more water and nutrients. This is especially important for calcium and magnesium. If the applied fertilizer uptake is more, it enhances the growth and increases the yield under irrigated condition than dry condition which in turn increases the water use efficiency. Hence, it is concluded that there is a close relationship between soil moisture and nutrient uptake by plants. The application of fertilizer or nutrients without adequate moisture in root zone is not useful to plants. Similarly, mutual benefits are also obtained from fertilizer. For *e.g.*, in drought situation balanced fertilized crops is able to withstand drought, than relatively low fertilized crop. Even well balanced fertilized crop may not show its normal growth and development unless adequate moisture is available. This is not only due to poor uptake, but also due to poor ET and which in turn reducing the use of absorbed nutrients for photosynthesis.

(ii) **Fertilizer use efficiency can be increased by :**

- Soil test to evaluate nutrient deficiency and use of proper quantity of the needed fertilizer. Applying fertilizer based on soil test values.
- Placement of fertilizers rather than broadcasting.
- Split doses of application at suitable time interval rather than bulk application.
- Controlled application of water to avoid leaching of fertilizers to deeper layers.

In most cases there is significant correlation between soil moisture regime, fertilizer requirement and the availability of fertilizer for plant use.

(a) **Nitrogen** - Mineralization of nitrogen increases as the water content of soil increases from PWP to FC and to saturation. When the fertilizer is applied to the surface soil, its uptake is inhibited when the soil dries.

(b) **Phosphorus** - Increase in soil moisture to an optimum level is generally possible because of reduced aeration and root penetration or the increased activity of sesquioxide fraction on 'P' fixation under reduced condition. In dry areas 'P' applied close to the seed is more effective than the broadcast application. The availability and uptake of P is less in dry or rain fed condition.

(c) **Potassium** - Soil moisture content affects the level of exchangeable 'K' in the soil. In high soil moisture zone, availability of k is increased. The results of studies on fertilizer-irrigation relationship lead to the following conclusions.

- Water use efficiency is raised by fertilizers by increased DMP (DRY matter production) and yield
- The response of fertilizer is generally of a higher order under irrigated condition than under unirrigated condition.

Response to frequent irrigation is generally enhanced by increased levels of fertilizer application, particularly crops grown for its vegetative plant parts.

11.26 SOIL MOISTURE ESTIMATION

Moisture content of the soil is determined by using various methods, viz., gravimetric method and by using sophisticated instruments like Tensiometers, Resistance blocks and Neutron probe.

1. **Tensiometer method** - Tensiometer is widely used for measuring soil water tension in the field and laboratory. A tensiometer consists of a 7.5 cm long porcelain cup filled with water, which is connected to water filled glass tube, a vacuum gauge and a hollow metallic tube holding all parts together (At the time of installation, system is filled with water through the opening at the top and closed with a rubber cork).

Principle - When installed in the soil at the required depth, water moves out through the porous cup till the surrounding soil is saturated. It creates a vacuum in the tube, which is measured in the vacuum gauge. When desired tension is reached, the field is irrigated.

Merits

- It is simple and easy to read soil moisture.
- Useful to crops requiring frequent irrigation at low tensions.

Limitations

- Costly (costs about Rs.150/- depending upon its length).
- Sensitivity is only up to 0.85 atmospheric pressure.

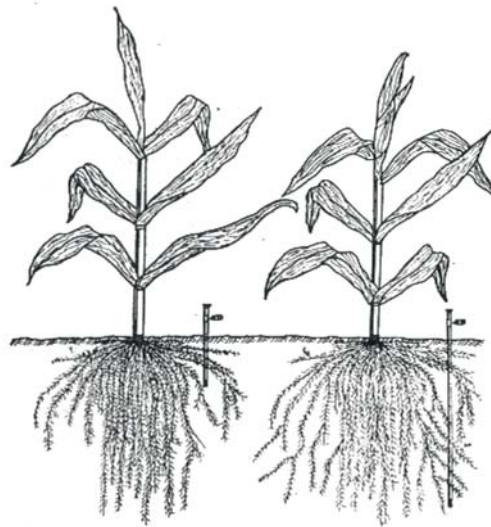
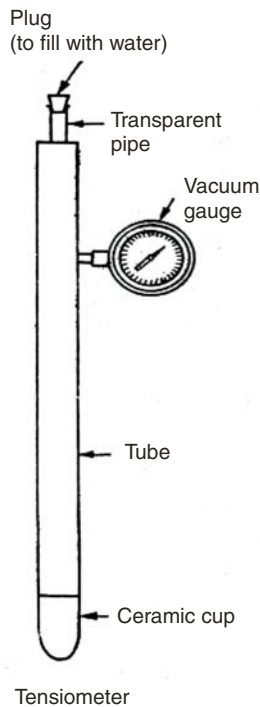

Fig. 11.22 Installation of tensiometer in the field

Materials required - Tube auger, hammer, tensiometer and coloured stakes.

Procedure - Select the spot for installation and bore the soil by driving a tube auger or a hollow pipe with sharp cutting edge which is driven into the soil by hammering it to the desired depth. Insert

the tensiometer into the access hole. Compact the soil around the stem of the tensiometer to the original density of soil and make a small soil heap near the tube so that water will not stagnate near the tensiometer. Take the reading in the morning at 8. a.m. Record the reading frequently so that the difference between two consecutive readings is not more than 10 centibars. Plot the readings on a paper against the days.

11.26.1 Estimation of Soil Moisture by Gravimetric Method

Moisture content in the soil is determined by (a) Weight basis and (b) Volume basis.

(a) **Weight basis** - This is otherwise called as gravimetric method. The method is extensively used for determination of moisture of the soil. In this method the soil moisture is expressed in oven dry weight basis. For example, when a soil is stated to contain 10% moisture on oven dry weight basis *i.e.*, that 100 g dry soil holds 10 g water. This is expressed as gravimetric wetness and it is expressed on dry soil basis.

Principle - The moisture contained in a known quantity of fresh soil sample is removed by using hot air oven and this moisture is expressed in percentage on dry weight basis.

Materials required - Screw soil auger, screw aluminum sample bottles, polythene bag, weighing balance, hot air oven.

Procedure - The soil sample in which the moisture content to be determined is taken from the field using the screw auger. The sample is transferred to an aluminium or stainless steel soil sample container. The weight of the sample container along with the soil sample is noted. Then it is placed in a hot air oven for 24-28 hours at 105 degrees centigrade. The dry weight of the soil sample with container is again weighed. From the dry and wet weights of the soil, moisture content can be calculated.

Fresh weight of soil sample with container = W1 grams

Oven dry weight of soil sample with Container = W2 grams

Empty weight of the container = W3 gram

Moisture content of the Soil on dry weight basis

$$\begin{aligned}
 &= \frac{(\text{Moisture lost from fresh sample})}{\text{Dry weight sample}} \times 100 \\
 &= \frac{((W1 - W3) - (W2 - W3))}{(W2 - W3)} \times 100 \\
 &= \frac{(W1 - W2)}{(W2 - W3)} \times 100
 \end{aligned}$$

(b) **Volume basis** - Expression of moisture content in percentage on dry weight basis may not include the amount of water available to plant. The conversion from weight to volume units can be made by

Moisture content % by volume = Moisture content % (by wt.) \times Bulk density (gm/cm²)

The percent by volume of moisture content obtained by the above relationship is numerically equal to the centimeter of water per meter depth of soil. Moisture content in a profile depth of soil can be obtained from moisture content on dry weight basis by multiplying it with bulk density and profile depth as = Moisture content (by wt) % \times Bulk density (g/cm³) \times profile depth (cm).

Cautions

- Sampling must be done maximum to the root zone of the crop.

- Sampling should be in between two plants or rows.
- If continuous soil moisture are to be studied, the sampling must be done within a radius of 50 cm from center.
- Do not unscrew the auger while taking out the sample. Instead, pull out the auger with the soil.
- Use a tube auger when the soil is dry to avoid spill out of sample.
- Fresh weight of samples should be weighed without much lapse of time to avoid moisture loss during transport and lapse of time.

Advantages

- Direct and simple
- More reliable
- More accurate

Limitations

- Sampling, transporting and repeated weighing give room for errors.
- Laborious and time consuming.
- Needs costly equipments and technical know-how.

11.26.2 Resistance Block

Gypsum blocks or plaster of paris resistance units are used for measurement of soil moisture *in situ*.

Principle - It works on the principle of conductivity of electricity. When two electrodes are placed parallel to each other in a medium and when electric current is passed, the resistance offered in between two electrodes for the flow of electricity is inversely proportional to the moisture content in the medium. Thus, when the block is wet, resistance is low (conductivity is high). The resistance at field capacity varies from 400 to 600 ohms and at wilting point it varies from 50,000 to 75,000 ohms. The reading on resistance are taken with a portable resistance meter (Bouyoucos meter) operated by dry cells.

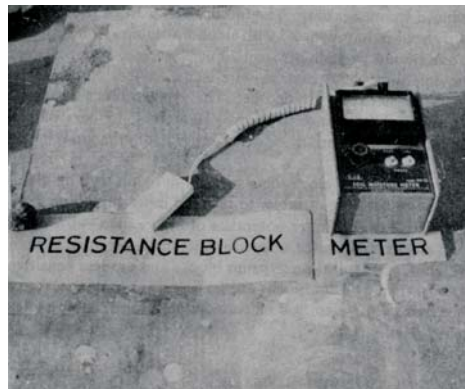

Fig. 11.23 Installation of resistance block

Material required - Gypsum or nylon blocks, a post-hole auger, bouyoucos moisture meter.

Procedure - Make a bore (access hole) with a posthole auger to the desired depth. Place the block inside and fill back the bore in small depth by packing the soil with a metal rod to the original density. Ensure and intimate contact of the blocks with the soil. There should not be any root pieces pebbles etc., near the blocks. Normally 3–5 blocks can be placed in one hole at a vertical interval of 30 cm for

experimental purpose. Heap the soil to a height of about 3 cm near the surface at the bore space to prevent any water stagnation. Irrigate the field and record the readings, check the resistance readings at the field capacity. In a wide spaced crop, install the block in between two rows of plants. Two or four units are enough for an acre of land for irrigation scheduling.

Merits

- Works at low moisture level up to wilting point.
- Suitable for repeated measurement at a point.
- Simple and easy method.

11.26.3 Neutron Probe Method

The neutron probe is designed as a field instrument for measuring in situ moisture content of the soil. The measurements are made by means of a probe, which is lowered into access tube installed vertically in the soil profile. Soil moisture is determined at specific depths to provide a soil moisture profile.

Principle - The probe contains a sealed Americium-Beryllium radioactive source having fast neutrons. When this source come in contact with soil, it emits fast neutrons into the soil and they collide with the hydrogen atoms in soil water causing the neutrons to scatter. Thus slow neutrons generated within the soil around is a function of soil moisture content. It is measured by boron trifluoride detector in the probe. This is amplified, displayed digitally as counts per second. The count rate is converted into soil moisture content by calibrations.

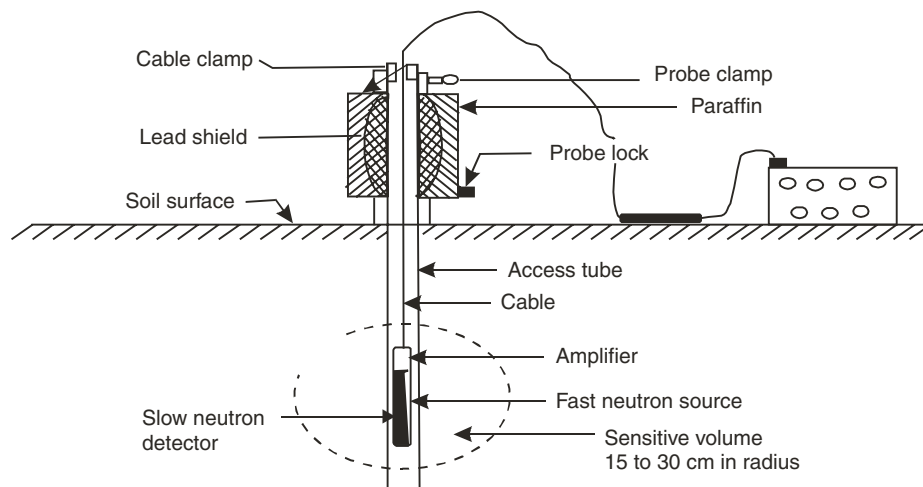

Fig. 11.24 Installation of neutron probe

- **Probe Carrier:** Cylindrical, made from tough PVC contains spherical polypropylene moderation shield for the fast neutron in its lower part.
- **Cable:** This connects the rate scaler to the probe, normally 5 m length but permitted to record at the correct count rate to the rate scaler.
- **Rate Scaler:** Cylindrical unit, attached to upper end of the carrier body; shows digitally the density of neutron cloud as counts per second.
- **The Probe:** Consists of a stainless steel cylinder 38 mm diameter and 75 mm long overall. Probe contains Americium-Beryllium source of fast neutrons. Probe can be operated below soil surface to a depth not exceeding 10 m.

- **The Transport case:** Serves as a store for the probe and the carrier. It contains compartments to cells, spare cable, field record books, and the charged neutrons.
- **The Access Tube:** The access tube is made out from material having low cross-section of absorption for both fast and slow neutrons. Galvanized iron pipe of 50 mm diameter with be good.
- **Procedure** - The access tube is first inserted into the soil by drilling a hole with the help of an auger. It is few centimeters above the soil and covered with an inverted case. The neutron probe is inserted into the access tube by carefully lowering down cable to the desired depth. Then the counting rates are determined. Initially the probe is to be adjusted and calibrated against volumetric determination of soil moisture content.

Merits

- More reliable.
- Very rapid method.
- Soil conditions are not disturbed.
- Repeated measurements are possible in the same location.
- Moisture contents at different depth at a smaller depth interval are possible in one stroke.

Demerits

- Costly (Rs. 2.0 lakhs) and not within the reach of farmers.
- Needs technical skill to operate the instrument.
- Radiation hazard may affect the device and soil. Periodic check up is needed.
- Small change in soil moisture content cannot be detected.

11.27 SOIL MOISTURE STRESS

Plant-water relations consist of a group of interrelated and interdependent processes. Thus, the internal water balance or degree of turgidity of a plant depends on the relative rates of water absorption and water loss, and is affected by the complex of atmospheric, soil and plant factors that modify the rates of absorption and transpiration. Water moves in response to a potential gradient. When the plant roots are in equilibrium with the soil water potential and the soil water potential gradients are near zero, a base level of leaf turgor or plant water potential is reached. Under the conditions of low evaporative demand during the night and early morning (Prior to sunrise) the values of water potential are often or near this level. An increase in the rate of transpiration coincident with the increase in evaporation, during the day, causes a decrease in the turgor pressure of the upper leaves and the development of water potential gradients through the plant from the evaporating surface of the leaves to the absorbing surface of the roots. Conditions are of such that the rate of water loss exceeds the rate of water absorption, causing an internal water deficit to develop in the plant. It is the internal water deficit, through its influence on many of the physiological processes in the plant that is directly responsible for the growth and yield of a crop under the prevailing conditions. The yield of crop is the integrated result of a number of physiological processes. Water stress can affect photosynthesis and respiration. It can also affect growth and reproduction. Reduction in leaf area, cell size and inter-cellular volume are common under water stress. Dehydration of protoplasm may be responsible for decreasing several physiological processes. Water stress at certain critical stages of plant growth causes more injury than at other stages. For example, irrigation at the crown root initiation stage has been shown to be essential for increased yield of wheat crop.

Drought Tolerance of Plants

Plants survive the periods of water stress by various means. Short duration varieties that avoid extensive drought period may be better drought resistant than other varieties. Researches on producing idio-type plants with leaf and stomatal characteristics suitable for drought resistance may result in developing suitable drought resistant varieties. Plants exhibit drought tolerance either because the plants are able to survive tissue desiccation. Drought-hardy plants usually have smaller cells than those living in moist habits. When desiccated, small cells undergo a much smaller proportionate reduction in volume than do large cells and therefore do not suffer large disturbances as the latter. In general, increased osmotic values are the characteristics of plants having superior drought hardiness. The higher osmotic values not only increases the ability of cells to retain water, but may also have an additional effect by increasing the resistance of the protoplasm to dehydration. One of the most effective safeguards against drought injury is a deep and wide-spreading root system as that of sorghum. Plants with shallow, sparsely branched root systems like potatoes, onions etc. Suffer sooner than deep-rooted species like Lucerne and maize.

Nutrient Management

Growth is the development of a plant as a whole or of a specific organ. Besides the genetic factors, the environmental factors grouped as climatic factors and soil factors influence plant growth. The supply of mineral nutrient elements to the plants is discussed in this chapter. A complete analysis of plants detects large number of elements. But only certain elements are essential. An element is said to be **essential** if the plant cannot complete its life cycle without it, and if the malady (deficiency) that develops in plants in its absence can be remedied only by that element.

Earlier 16 elements were considered as essential for plant growth. They are carbon, hydrogen, oxygen, nitrogen phosphorus, potassium, calcium, magnesium, sulphur, iron, manganese, zinc, copper, molybdenum, boron and chlorine. Recently, sodium, cobalt, vanadium, silicon, selenium, gallium, aluminium and iodine are added to the above list. One or the other of these elements (recently added) has been found to be essential for a particular group or species of plants. Carbon dioxide, water and molecular oxygen are the forms in which C, H and O are assimilated by plants. Others are taken up by plants from the soil. Nutrient uptake by plants accounts for about 10 percent of total dry weight of crops, the remaining percentage being water. The chemical symbol and the ionic forms in which the essential elements are absorbed by the plants are given in Table 12.1.

Table 12.1. The Chemical Symbol and the Ionic Forms of essential Elements

	<i>Element</i>	<i>Symbol</i>	<i>Form (s) of absorption by plants</i>
1.	Carbon	C	CO ₂
2.	Hydrogen	H	H from H ₂ O
3.	Oxygen	O	Elemental O ₂ and O ₂ from H ₂ O
4.	Nitrogen	N	NH ₄ ⁺ , NO ₃ ⁻ also as organic CO (NH ₂) ₂ and molecular nitrogen
5.	Phosphorus	P	HPO ₄ ²⁻ , H ₂ PO ₄ ⁻ also as Nucleic acid, Phytin
6.	Potassium (Kalium)	K	K ⁺
7.	Calcium	Ca	Ca ⁺⁺
8.	Magnesium	Mg	Mg ⁺⁺
9.	Sulphur	S	SO ₃ ²⁻ , SO ₄ ²⁻

(Contd.)

10.	Iron	Fe	Fe ⁺⁺ , Fe ⁺⁺⁺
11.	Zinc	Zn	Zn ⁺⁺
12.	Manganese	Mn	Mn ⁺⁺
13.	Copper	Cu	Cu ₂ ⁺⁺
14.	Boron	B	BO ₃ ³⁻
15.	Molybdenum	Mo	MoO ₄ ²⁻
16.	Chlorine	Cl	Cl ⁻
17.	Silicon	Si	Si(OH) ₄
18.	Sodium	Na	Na ²⁺
19.	Cobalt	Co	Co ²⁺
20.	Vanadium	V	V ⁺

12.1 CLASSIFICATION OF ESSENTIAL ELEMENTS

Essential elements needed for the crop growth are broadly classified:

12.1.1 Based on the relative Quantity that is normally present in Plants

- *Macro nutrients (Major Nutrients/primary nutrients):* C, H, O, N, P, K
- *Secondary nutrients:* Ca, Mg, S
- *Micro Nutrients (Minor/Tertiary/Trace elements):* Fe, Mn, Zn, Cu, Mo, B, Cl, and Na, Se, Co, V, Ga, Al and I₂.

12.1.2 Based on their Chemical Nature

- *Metals:* K, Ca, Mg, Fe, Zn, Mn, Cu, Co and V etc.
- *Non-Metals:* C, H, O, N, P, S, B, Mo, Cl, Si, etc.
- *Cations:* NH₄⁺, K⁺, Ca²⁺, Fe²⁺, Mg²⁺, Mn²⁺, Cu²⁺, Zn²⁺
- *Anions:* NO₃⁻, HPO₄²⁻, H₂PO₄⁻, SO₄²⁻, BO₃³⁻, MoO₄²⁻, Cl⁻ etc.

12.1.3 Based on General Function

- As a constituent of either organic or inorganic compounds—N, S, P, Ca, B, Fe and Mg.
- As an activator, cofactor in prosthetic group of enzyme systems—K, Mg, Ca, Fe, Zn, Mn, Cu, Mo, Na and Cl.
- As a charge carrier in oxidation–reduction reactions—P, S, Fe, Mn, Cu, Mo.
- As an osmosis regulator and for electron chemical equilibrium in cells—K, Na and Cl.

12.1.4 Based on the Mobility in Plants

- Highly mobile : N, P, K
- Moderately mobile : Zn
- Less mobile : S, Fe, Cu, Mn, Cl, Mo
- Immobile : Ca, B

12.2 NUTRIENTS–ROLE, DEFICIENCY, METHOD OF CONTROL AND TOXICITY

The role of nutrients, deficiency, control of deficiency and toxicity are given in Table 12.2.

Table 12.2. Role of Nutrients, Deficiency, Control of Deficiency and Toxicity

<i>Nutrient (Element)</i>	<i>Role of nutrients</i>	<i>Deficiency symptoms of nutrients</i>	<i>Control of deficiency</i>	<i>Symptoms under excess nutrients</i>
1. Nitrogen (N)	<ol style="list-style-type: none"> 1. It is constituent of chlorophyll. 2. N makes plant dark green 3. It increases vegetative growth, protein content and cation exchange capacity in plant roots 4. Encourage the formation of good quality foliage 	<ol style="list-style-type: none"> 1. Lower leaves turn yellow 2. Growth of plant is stunted 3. Shedding of leaves and fruits 	<ol style="list-style-type: none"> 1. Use of nitrogen fertilizer in the soil 2. Foliar spray of urea 	<ol style="list-style-type: none"> 1. Blackening around tips of older leaves 2. Delays maturity 3. Encourages Lodging 4. Makes plant more susceptible to pests and diseases 5. Poor root growth
2. Phosphorus (P)	<ol style="list-style-type: none"> 1. Stimulates root growth and formation 2. Helps in cell division 3. Hasten maturity 4. Makes plant more tolerant to drought, cold, insects and diseases 5. Increase P and Ca in plants 6. Increase tillers and ratio of grain to straw in crop 	<ol style="list-style-type: none"> 1. Leaves become smaller in size 2. Leaves and stems become purple 3. Delay in maturity 4. Growth is stunted 	<ol style="list-style-type: none"> 1. Application of phosphatic fertilizers in the soil, <i>e.g.</i>, super phosphate 	<ol style="list-style-type: none"> 1. Necrosis and tip dieback 2. Interveinal chlorosis in younger leaves 3. Marginal scorch of older leaves
3. Potassium (K) (Kalium)	<ol style="list-style-type: none"> 1. K–helps in translocation 2. Imparts, vigour and growth to plants 3. Makes plant more tolerant to drought, cold insects and diseases. 4. Reduces lodging 5. Increases the availability of N and P 	<ol style="list-style-type: none"> 1. Margin of leaves turn brown and dry up 2. The older leaves develop brown colour 3. Stunted growth 	<ol style="list-style-type: none"> 1. Use of potassic fertilizer in the soil <i>e.g.</i>, muriate of potash 	<ol style="list-style-type: none"> 1. Plants have luxury consumption hence not toxic

(Contd.)

<i>Nutrient (Element)</i>	<i>Role of nutrients</i>	<i>Deficiency symptoms of nutrients</i>	<i>Control of deficiency</i>	<i>Symptoms under excess nutrients</i>
4. Calcium (Ca)	<ul style="list-style-type: none"> 6. Increases the size of root and tuber 1. Promotes early root growth 2. Ca is constituent of cell 3. Increases stiffness of straw (stem) 4. Improves soil structure 5. Keeps soil neutral 	<ul style="list-style-type: none"> 1. Terminal bud dies 2. Leaves become wrinkled 3. new leaves shows symptoms 	<ul style="list-style-type: none"> 1. Use of calcium carbonate or calcium hydroxide in the soil 2. Use of gypsum 	
5. Magnesium (Mg)	<ul style="list-style-type: none"> 1. Constituent of chlorophyll 2. Increases photosynthesis 3. Regulates uptake of nutrients 4. Promotes the formation of oils and fats 	<ul style="list-style-type: none"> 1. Vein of leaves remain green and inter-veinal chlorosis 2. Symptoms on older leaves 	<ul style="list-style-type: none"> 1. Foliar application of magnesium sulphate (Epsom) 	<ul style="list-style-type: none"> 1. May induce K deficiency
6. Sulphur (S)	<ul style="list-style-type: none"> 1. Helps in chlorophyll formation 2. Stimulates root growth seed formation and nodule formation 3. Encourages plant growth 4. S is constituent of enzymes and proteins 	<ul style="list-style-type: none"> 1. The whole leaf in plant has light green colour 	<ul style="list-style-type: none"> 1. Foliar application of sulphur or sulphate 	<ul style="list-style-type: none"> 1. Reduction in leaf size
7. Iron (Fe)	<ul style="list-style-type: none"> 1. Helps in chlorophyll formation 2. Acts as an oxygen carrier 3. Helps in protein synthesis 	<ul style="list-style-type: none"> 1. Yellowing of new check leaves 2. Chlorosis 	<ul style="list-style-type: none"> Spraying of 0.5% Ferrous sulphate on foliage 	<ul style="list-style-type: none"> Bronzing of older leaves is common in low land rice grown under acid soils
8. Manganese (Mn)	<ul style="list-style-type: none"> 1. Acts as a catalyst in oxidation reduction reaction 2. Act as activator of many enzymes 3. Helps in chlorophyll synthesis 	<ul style="list-style-type: none"> 1. Brown patch on leaves 2. Reddening of leaves in cotton 	<ul style="list-style-type: none"> 1. Soil or foliar application of manganese sulphate 	<ul style="list-style-type: none"> 1. Spots on the veins of the leaf blade and leaf sheath 2. Stunted plant

(Contd.)

<i>Nutrient (Element)</i>	<i>Role of nutrients</i>	<i>Deficiency symptoms of nutrients</i>	<i>Control of deficiency</i>	<i>Symptoms under excess nutrients</i>
9. Boron (B)	1. Helps in uptake and utilization of calcium 2. Helps in protein synthesis	1. The leaves thicken and margin roll upward 2. Younger leaves are dwarf 3. Top-rot diseases of tobacco	1. Foliar spray of boric acid or borax 2. Use of boron in soil	1. Inter veinal chlorosis at the tips of the older leaves along the margins 2. Leaves turn brown and dry up
10. Copper (Cu)	1. Helps in oxidation-reduction reaction			<i>contd.</i>
11. Molybdenum (Mo)	1. Helps in absorbing atmospheric nitrogen by nodule bacteria in legume 2. Helps in protein synthesis	1. Petiole of the leaves remain intact but shedding of margin and other part of leaves 2. Curling of leaves	1. Soil or foliar application of sodium molybdate or ammonium molybdate	Not common
12. Chlorine (Cl)	1. Essential for photosynthesis process 2. Keeps osmotic pressure normal in cell sap	1. Yellowing of leaves (white plant)	1. Potassium chloride application in the soil	1. Burning of leaf tips or margins 2. Reduce leaf size
13. Zinc (Zn)	1. Constituent of a number of enzymes 2. Helps in formation of growth hormones 3. Act as catalyst in chlorophyll formation	1. White leaf become rusty-brown in colour 2. Stunted growth	1. Soil application of Zinc sulphate @ 25-50 Kg/ha. 2. Foliar application of 0.5% zinc sulphate	1. Induces iron chlorosis

12.3 NUTRIENT DEFICIENCY SYMPTOMS

Plant symptoms can be grouped into five types as follows:

Chlorosis: Yellowing, either uniform or interveinal of plant tissue due to reduction in the chlorophyll formation process.

Necrosis: Refers to death of plant tissue leading to dead spots.

Lack of new growth or terminal growth resulting in “**rosetting**”.

Accumulation of anthocyanin and an appearance of a reddish colour.

Stunting or reduced growth with either normal or dark green colour or **yellowing**.

Nutrients are continuously removed from the soil by crops in addition to losses by leaching, volatilization and erosion. These nutrients are added to the soil by external sources to maintain soil fertility and sustainable production. Manure is the organic material derived from animal, human and plant residues, which contains plant nutrients in complex organic forms. The major organic sources are manures are farm waste, cattle shed waste, human habitation waste, slaughter house waste, fish meal,

by-products of agro-industries etc. The manures are bulky, concentrated, green and green leaf manures depending on their volume and nutrient content. Of these two sources, most widely used all over the world, one is organic in nature—the organic manures simply called manures and the other comprises the synthetic or naturally occurring chemical fertilizers simply called fertilizers.

12.4 ORGANIC MANURES

Organic manures include plant and animal by-products such as oil cakes fish manures and dried blood from slaughter houses. Before their organic nitrogen used by the crops it is converted through bacterial action into readily usable ammonical N and nitrate N. These manures are therefore, relatively slow acting, but they supply available N for a longer period.

Advantages - Organic manures supply plant nutrients including micronutrients. Organic manures improve physical properties of the soil, water holding capacity, hydraulic conductivity, infiltration capacity of the soil. CO₂ released during decomposition combines with water and forms carbonic acid and act as CO₂ fertilizer. Organic manures supply energy (food) for microbes and increase availability of nutrients and improve soil fertility. Green manures have the additional advantage of fixing atmospheric nitrogen leading to nitrogen economy in crop production and green manures draw nutrients from lower layers and concentrate them in the surface soil for the use of succeeding crop.

Classification

A. Bulky organic manures

- (i) *FYM*: (a) Cattle manure, (b) Sheep manure, (c) Poultry manure
- (ii) *Compost*:
 - (a) Village/rural compost from farm-wastes
 - (b) Town/urban compost from town refuses
- (iii) *Sewage and sludge*

B. Concentrated organic manures

1. **Oil cakes**
 - (a) Edible oil cakes (*i.e.*, used for cattle feeding) - (i) Mustard cake, (ii) Groundnut cake, (iii) Sesame cake, (iv) Linseed cake
 - (b) Non edible oil cakes (*i.e.*, used as manures) - (i) Castor cake, (ii) Neem cake, (iii) Sunflower cake, (iv) Mahua cake, (v) Karanja cake
2. **Slaughter house wastes** - (i) Blood meal, and (ii) Bone meal
3. **Fish meal**
4. **Guano** - Material obtained from the excreta and dead bodies of sea bird

C. Green manures

- (a) *Leguminous plant* (example: Sunn hemp, *Sesbania sp.*, mungbean, cowpea, guar, senji, berseem)
- (b) *Non-leguminous plant* (example: Sorghum, pearl millet, maize, sunflower)

D. Green leaf manures

Green leaves of trees like neem, pungam, glyricidia, vadhanarayana etc.

12.4.1 Bulky Organic Manures

Bulky organic manures are those manures, which are generally bulk in quantities and poor in plant

nutrients (low quantities of plant nutrients). Example: Farm yard manure, compost, sewage and sludge etc.

A. Farm Yard Manure (FYM)

It is the manure produced in the farm which is made up of excreta (dung and urine) of farm animals, the bedding materials provided for them and miscellaneous farm and house hold wastes. Straw, peat and saw dust, dry leaves etc., are used as bedding material for farm animal and accounts to 3–4 kg per animal per day. The bedding material is called '*litter*' and it absorbs urine voided by animals. It is not a standardized product and its value depends on the kind of feed fed to the animal, the amount of straw used and the manner of storage. In general FYM contains 0.8% N, 0.41% P_2O_5 and 0.74% K_2O . The excreta of horses and sheep are drier than other and do not get compacted in the heap. There is considerable aeration, bacterial activity and rise in temperature in the manure. They are therefore called '*hot manures*' in the temperate countries. Pig and cattle manure contain more moisture and compacted in the manure pit. Their decomposition is not as vigorous as that of hot manures and the rise of temperature is also low. Therefore pig and cattle manures are called "*cold manures*". The decomposition of cattle manures may be slower comparatively under temperate regions but it is rapid enough under tropical condition.

B. Compost

It is a manure derived from decomposed plant residues usually made by fermenting waste plant materials heaped or put in a pit usually in alternate layers with a view to bring the plant nutrients in a more readily available form.

Super compost: Compost fortified with super phosphate is called as super compost. *Starters* are the materials added to the composting organic wastes, which provide the decomposing organism. Pig dung slurry is a valuable starter and provides necessary organisms. Even cow dung slurry can be used as starter. Generally ammonium sulphate and super phosphate are added to the layers at the time of furrowing the composting heap to enrich nitrogen and phosphorus status of compost respectively. Fertilizers accelerate and hasten the decomposition of organic matter or wastes.

C. Sewage and Sludge

In cities human excreta are flushed out with large quantities of water, which is known as sludge. It contains two components, one is solid portion called sludge and another is liquid portion called sewage water. In general, the sludges are rich in N and P, and low in K. The sewage water is used for irrigation after proper treatments.

Table 12.3. Nutrient Content of the Bulky Organic Manures

Manure	N	Percentage composition of	
		P_2O_5	K_2O
Cattle dung	0.40	0.20	0.20
Cattle urine	1.00	–	1.35
Sheep and goat dung	0.75	0.50	0.45
Sheep and goat urine	1.35	0.05	2.10
Sheep and goat manure	3.00	1.00	2.00

(Contd.)

<i>Manure</i>	<i>N</i>	<i>Percentage composition</i>	
		<i>P₂O₅</i>	<i>K₂O</i>
Poultry manure	3.03	2.63	1.40
Horse manure	2.00	1.50	1.50
Horse urine	1.35	–	1.25
Pig dung	0.60	0.50	0.40
Pig urine	1.10	0.10	0.45
Farm litter compost	0.50	0.15	0.50
Rural compost	1.22	1.08	1.47
Town compost	1.40	1.00	1.40
Water hyacinth compost	2.00	1.00	2.30
Vermicompost	3.00	1.00	1.50
Night soil	5.50	4.00	2.00
Paddy straw	1.50	1.34	3.37
Sugarcane trash	2.73	1.81	1.31
Sewage sludge	1.5-3.5	0.75-4.00	0.3-0.6

12.4.2 Concentrated Organic Manures

Concentrated organic manures are those manures which are rich in particular nutrients (N) but relatively having low volume of organic materials. Example: Oil cakes, blood and bone meal, fishmeal, press mud etc.

A. Oil cakes

Oil cake is the residue left after the oil is extracted from oil containing seed. The manurial values of oil cake lie mainly in its nitrogen contribution though it is in small quantities. The nitrogen content varies between 3% and 9% (Table 12.4). The C:N ratio is usually 3–15 for most of the oil cakes.

Table 12.4. Nutrient Content of some Concentrated Organic Manures

<i>Manure</i>	<i>Percentage composition</i>		
	<i>N</i>	<i>P₂O₅</i>	<i>K₂O</i>
Castor cake	4.0-4.4	1.9	1.4
Groundnut cake	6.5-7.5	1.3	1.5
Cotton seed cake (decorticated)	6.9	3.1	1.6
Cotton seed cake (undecorticated)	3.6	2.5	1.6
Linseed cake	5.6	1.4	1.3
Coconut cake	3.4	1.9	1.9
Neem cake	5.2-5.6	1.1	1.5
Safflower cake (decorticated)	7.9	2.2	1.9

(Contd.)

Manure	Percentage composition		
	N	P ₂ O ₅	K ₂ O
Safflower (undecorticated)	4.9	1.4	1.2
Sesamum cake	4.7-6.2	2.1	1.3
Mahua cake	2.5	0.8	1.9
Niger cake	4.7	1.8	1.3
Pungam cake	4.0	1.0	1.3
Raw bone meal	4.0	20-25	–
Steamed bone meal	4.7	25-30	–
Basic slag	4.0	1.0	1.3
Fish meal	4-10	3-9	1.5
Blood meal	10-12	1-2	1.0
Meat meal	9-11	3.5	–
Horn and hoof meal	10-15	1	–
Press mud	1-1.5	4-5	2-7
Guano (Peruvian bird)	11-16	8-12	2-3

12.4.3 Green Manure and Green Leaf Manure

Green manuring is the act of growing of quick growing crop preferably legumes and ploughing *in situ* and incorporated into the soil. Whereas green leaf manuring is incorporation of green matter into the soil transported from elsewhere. The percentage N of some of the green/green leaf manures is given in Table 12.5.

Table 12.5. Nutrient Content of Green Manure Crops and Green Leaf Manures

Plant	Scientific Name	Nutrient content (%) on air dry basis		
		N	P ₂ O ₅	K ₂ O
Green manure				
Sunn hemp	<i>Crotalaria juncea</i>	2.30	0.50	1.30
Manila agathi	<i>Sesbania rostrata</i>	3.30	0.60	1.20
Daincha	<i>Sesbania aculeata</i>	3.20	0.60	1.20
Pillipesara	<i>Phaseolus trilobus</i>	2.80	0.50	1.15
Sesbania	<i>Sesbania speciosa</i>	2.71	0.53	2.21
Kolinji	<i>Tephrosia purpurea</i>	3.10	0.52	1.18
Green Leaf manure				
Glyricidia	<i>Glyricidia sepium</i>	2.76	0.28	4.60
Pongamia	<i>Pongamia glabra</i>	3.31	0.44	2.39
Neem	<i>Azadiracta indica</i>	2.83	0.28	0.35
Gulmohur	<i>Delonix regia</i>	2.76	0.46	0.50

(Contd.)

Plant	Scientific Name	Nutrient content (%) on air dry basis		
		N	P ₂ O ₅	K ₂ O
Vadanarayanan	<i>Delonix elata</i>	3.51	0.31	0.43
Subabul	<i>Leucaena leucocephala</i>	3.50	0.48	0.81
Peltophorum	<i>Peltophorum ferrugenum</i>	2.63	0.37	0.50
Weeds				
Parthenium	<i>Parthenium hysterophorus</i>	2.68	0.68	1.45
Water hyacinth	<i>Eichhornia crassipes</i>	3.01	0.90	0.15
Sarannai	<i>Trianthema portulacastrum</i>	2.64	0.43	1.30
Aduthoda	<i>Aduthoda vesica</i>	1.32	0.38	0.15
Ipomea	<i>Ipomea cornea</i>	2.01	0.33	0.40
Calotrophis	<i>Calotrophis gigantean</i>	2.06	0.54	0.31
Cassia	<i>Cassia fistula</i>	1.60	0.24	1.20



Fig. 12.1 Raising Daincha Green Manure in rich field

(a) **Stem nodulating green manure** - Leguminous green manure plants produce root nodules and fix atmospheric N. *Sesbania rostrata* produces nodules on their stem besides root nodulation. This special feature adds their green manurial value. It is tropical legume of Senegal origin and thrives well under flooded and water logged conditions. It is capable of producing 22 tones of fresh biomass and could accumulate 150 kg N/ha in 45 days. It contains 3.3% N.



Fig. 12.2 A view of Green Leaf Manure application in the main field

(b) ***Daincha in reclamation of saline and alkali soils*** - Green manuring practice in sodic soil has an unique importance since it adds acids in the reclamation process, besides improving the fertility status of the soil. Usually the fertility status of sodic soil is very poor because of its high pH and exchangeable sodium percentage. The soil organic matter content, a measure of available nitrogen, is very low *i.e.*, 0.1-0.5% in sodic soil because sodium carbonate and sodium bicarbonate salts in solution dissolve the humus. Further the available nitrogen is much lower in the subsoil layers of the sodic soils.

Reclamation of alkali soils basically involves replacing Na on the exchange complex with more favourable cations. The solubility of lime, which is always present in alkali soils in significant amounts, is very low, because the potassium content of alkali soil is high. There is an intimate relationship between soil pH, partial pressure of CO₂ and calcium ion activity in calcareous alkali soils. Increase in CO₂ production in the soil enables to increase the soluble Ca status of soils. This in turn, replaces exchangeable Na, resulting in the improvement of alkali soils. Soil incorporation of easily decomposable plant material results in increased and rapid production of CO₂. For this reason, green manuring has been suggested as an important management practice for the reclamation of alkali soils.

Sesbania aculeata and *Delonix elata* are very effective green manures and green leaf manures respectively used for reclamation of sodic soils. Daincha (*Sesbania aculeata*) is highly resistant to both drought and water stagnation and salinity and alkalinity. It can be grown in soils with pH 4.5 to 9.5. It produces green matter of 20 t/ha in 90 days. Daincha contains 3.2% N and 34% Ca on dry weight basis which helps to replace Na from sodic soils. The acid juice (pH 4.0) and high seed protein content (58%) seems to be the cause of its resistance to sodicity stress. During the reclamation of sodic soils gypsum @ 50% of gypsum requirement (GR) has to be spread uniformly over the field. The surface soil is to be ploughed to mix the gypsum in the sodic soil. Irrigate the field with 10-15 cm depth of water and maintain the same water depth for 3-4 days. At this stage, the sodium content in clay particles are

replaced by the calcium ions from the gypsum, allowing the sodium to wash out of the field as Leachate. The field has to be kept with stagnant water for 3–4 times after each drainage process. Apply the vadanarayanan (*Delonix elata*) leaves and daincha @ 5 t/ha without allowing the soil to dry. After four to five days of incorporation of green leaves, the field crop like rice with preferably a tolerant variety CO 43, TRY 1 etc.

12.5 FERTILIZERS

Fertilizers are synthetic (commercially manufactured) or naturally occurring chemical compounds either dry solid or liquid that added to the soil to supply one or more plant nutrients for crop growth.

12.5.1 Classification

The fertilizers are classified based on whether the fertilizer supplies a single or more than one nutrient, their chemical nature and commercial mode of supply as straight, compound, complex and mixed.

12.5.1.1 Straight Fertilizers

When a fertilizer contains and is used for supplying a single nutrient, it is called a straight fertilizer. This is further classified as nitrogenous, phosphatic and potassic fertilizers depending on the specific macro nutrient present in the fertilizer.

A. Nitrogenous fertilizers

N fertilizers are those fertilizers containing N as major nutrient. It may be either a nitrate or ammonium or amide fertilizer depending on the form of nitrogen present. The nutrient composition of different N fertilizers are listed in Table 12.6.

B. Phosphatic fertilizers

They are classified into three groups, based on the solubility of phosphate contained in the fertilizer.

Table 12.6. Nutrient Composition of different N Fertilizers

Sources	Nutrient content (Percent) available							
	N	P ₂ O ₅	K ₂ O	CaO	MgO	S	Cl	
Ammonium sulphate	20.6	-	-	-	-	24.0	-	NH ₄ ⁺
Ammonium chloride	25-26	-	-	-	-	-	66	”
Ammonium nitrate	33-34	-	-	-	-	-	-	NH ₄ and NO ₃
Ammonium sulphate nitrate	26.0	-	-	-	-	-	-	”
Anhydrous ammonia	82.0	-	-	-	-	-	-	”
Calcium ammonium nitrate	35	-	-	8.1	4.5	-	-	”
Calcium nitrate	15	-	-	34	-	-	-	NO ₃
Sodium nitrate	16	-	-	-	-	-	-	”
Urea	46	-	-	-	-	-	-	Amide
Calcium cyanamide	21	-	-	-	-	-	-	”

- (i) **Water soluble phosphate (Mono calcium phosphate) $\text{Ca}(\text{H}_2\text{PO}_4)_2$**
 Single super phosphate 16% $\text{Ca}(\text{H}_2\text{PO}_4)_2, \text{H}_2\text{O}$
 Double super phosphate 32% $2\text{Ca}(\text{H}_2\text{PO}_4)_2, \text{H}_2\text{O}$
 Triple super phosphate 48% $3\text{Ca}(\text{H}_2\text{PO}_4)_2, \text{H}_2\text{O}$
- (ii) **Citric acid soluble phosphate (Di-calcium phosphate) $\text{Ca}(\text{H}_2\text{PO}_4)_2$**
 Basic slag $(\text{CaO})_3 \text{P}_2\text{O}_5 \text{SiO}_2$ 14-18% (by-product from steel industry)
 Di-Calcium Phosphate $\text{Ca}_2(\text{H}_2\text{PO}_4)_2$ 34-39%
- (iii) **Insoluble phosphate (Tri-calcium phosphate) $\text{Ca}_3(\text{PO}_4)_2$**
 Rock phosphate 20-40% $\text{Ca}_3(\text{PO}_4)_2 \text{CaF}_2$
 Raw bone meal 20-25% $\text{Ca}(\text{PO}_4)_3 \text{CaF}_2$ (2-4% N)
 Steamed bone meal 22%-30%

(C) Potassic fertilizers

Muriate of potash (KCl)	60%
Sulphate of potash (K_2SO_4)	48-52%
Potassium nitrate (KNO_3)	48% (N-13%)
Schoenite ($\text{K}_2\text{SO}_4, \text{MgSO}_4 \cdot 6\text{H}_2\text{O}$)	22-24%

12.5.1.2 Compound Fertilizers

Compound fertilizers are the commercial fertilizers in which two or more primary nutrients are chemically combined. For example: DAP. DAP contains 18% N and 46% P_2O_5 .

Table 12.7. Compound Fertilizers

Fertilizer	N	P_2O_5	K_2O
Di ammonium phosphate (DAP)	18	46	-
Mono ammonium phosphate	11	48	-
Urea ammonium phosphate	28	28	-
Ammonium phosphate	16	20	-

12.5.1.3 Complex Fertilizers

Complex fertilizers are the commercial fertilizers containing at least two or more of the primary essential nutrients at higher concentration in one compound. The nutrients in complex fertilizers are physically mixed.

Table 12.8. Complex Fertilizers

Fertilizer	N	P_2O_5	K_2O
Complex fertilizers	17	17	17 (MF)
	14	28	14 (MF)
	10	26	26 (IFFCO)
	12	32	16 (IFFCO)
	14	36	12 (IFFCO)
Nitro-phosphate-potash	15	15	15
Gromor	14	35	14

12.5.1.4 Mixed Fertilizers/Fertilizers Mixtures

They are physical mixtures of two or more straight fertilizers. Sometimes a complex fertilizer is also used as one of the ingredients. The mixing is done mechanically. The fertilizer mixtures are usually in powder form but techniques have been developed for granulation of mixtures so that each grain will contain all the nutrients mixed in the mixture.

Table 12.9. Standard Fertilizer Mixtures for specific Crops

Mixture No.	Composition %			Crops
	N	P ₂ O ₅	K ₂ O	
1.	14	7	0	Millets, rainfed cotton
2.	12	6	6	Fruit crops
3.	6	6	12	Fruit crops
4.	6	12	6	Potato, paddy
5.	9	9	9	Paddy, millets
6.	15	0	15	Top dressing for paddy, millets
7.	4	8	12	Groundnut
8.	6	6	18	Banana
9.	10	0	30	Banana
10.	15	5	5	Sugarcane
11.	16	4	4	Sugarcane
12.	16	0	12	Top dressing mixture
13.	10	10	0	Sorghum, pearl millet
14.	14	4	12	Coconut
15.	15	25	15	Paddy, millets, vegetables
16.	20	0	10	Sugarcane
17.	30	30	50	Tea
18.	17	17	17	Paddy

(a) Salts containing secondary nutrients

Calcium, sulphur and magnesium are termed as secondary nutrients since they are required comparatively less in quantity than primary nutrients (N, P, K) but more than micronutrients. They are added to the soil through some fertilizers, like ammonium sulphate, calcium ammonium nitrate and phosphatic fertilizers. Commercial fertilizers containing these secondary nutrients are: (i) Magnesium sulphate (Epsom) – 9.6% Mg and 13% S, and (ii) Calcium sulphate (Gypsum) – 9% Ca and 23% SO₄.

(b) Salts containing micronutrients

Copper, zinc, boron, manganese, molybdenum, iron and chlorine are termed as micronutrients since they are required in micro quantities. They are added to the soil through some commercial fertilizers (Table 12.10).

Table 12.10. Salts containing Micronutrients

Sl.No.	Salt	Formula	Nutrient content
1.	Copper sulphate	$\text{CuSO}_4 \cdot 5\text{H}_2\text{O}$	25-35% Cu
2.	Zinc sulphate	$\text{ZnSO}_4 \cdot 7\text{H}_2\text{O}$	22-35% Zn
3.	Borax (sodium borate)	$\text{Na}_2\text{B}_4\text{O}_7 \cdot 10\text{H}_2\text{O}$	10.6% B
4.	Manganese sulphate	$\text{MnSO}_4 \cdot 4\text{H}_2\text{O}$	23% Mn
5.	Sodium molybdate	$\text{Na}_2\text{MoO}_4 \cdot 2\text{H}_2\text{O}$	37-39% Mo
6.	Ammonium molybdate	$(\text{NH}_4)_6 \text{Mo O}_4 \cdot 4\text{H}_2\text{O}$	54% Mo
7.	Ferrous sulphate	$\text{FeSO}_4 \cdot 7\text{H}_2\text{O}$	20% Fe

12.6 BIO FERTILIZERS

Bio fertilizers are the living organisms capable of fixing atmospheric nitrogen or making native soil nutrients available to crops. Atmospheric nitrogen is fixed effectively by the microorganisms either in symbiotic association with plant system (Rhizobium, Azolla) or in associative symbiosis (Azospirillum) or in free living system (Azotobacter, phosphobacterium, blue green algae) or in micorhizal symbiosis (VAM fungi).

(a) *Rhizobium* - Rhizobium bacteria can fix atmospheric nitrogen symbiotically. They live in the nodules of host plants belonging to the family leguminosae. The quantities of nitrogen fixed by Rhizobia differ with the rhizobial strain, the host plant and the environmental conditions under which the two develop. The species of the genus Rhizobium are numerous and require certain host plants. For example, the bacteria that live symbiotically with soybean will not do so with alfalfa. A list of common legumes and the rhizobial strains by which they are inoculated is given in the Table 12.11.

Table 12.11. Classification of Rhizobium–Legume Associations

	<i>Rhizobium species</i>	<i>Legumes</i>
1.	<i>Rhizobium meliloti</i>	Alfalfa (Lucerne)
2.	<i>R. trifolii</i>	Clover
3.	<i>R. leguminosarum</i>	Peas
4.	<i>R. phaseoli</i>	Beans
5.	<i>R. lupine</i>	Lupine
6.	<i>R. japonicum</i>	Soybean
7.	<i>Rhizobium sp.</i>	Cowpea

Fixation of nitrogen by the leguminous plants will be at maximum only when the level of available soil nitrogen is at the minimum. It is sometimes advisable to include a small amount of nitrogen in the fertilizer of legume crops at sowing time (as a starter dose) to ensure that the young seeding will have an adequate supply until the rhizobia can become established. Larger quantity of nitrogen or continued applications of nitrogen, however reduce the activity of the rhizobia and therefore they are generally

uneconomical. Rhizobial inoculation was found to fix 15-35 kg N per ha in a season on different pulse crops. Rhizobial inoculation can save up to 25% N fertilizer application to crops.

(b) *Azolla* - It is a small water fern of worldwide distribution under natural conditions. It contains the heterocystous blue green algae *Anabaena azollae* as a symbiont in an enclosed chamber in the dorsal leaf lobes. *Azolla* derives all its total nitrogen requirement by the symbiotic association with the algae. The *Azolla*-*Anabaena* system is agronomically most significant plant algal association and this is being employed as a nitrogen source for rice culture. There are six species of *Azolla*. They are *Azolla caroliniana*, *Azolla filiculoides*, *Azolla mexicana*, *Azolla nilotica*, *Azolla microphylla* and *Azolla pinnata*. *Azolla* contains 3.1-4.2% N; 0.16% P₂O₅ and 0.18% K₂O on dry weight basis.

(c) *Azospirillum* - This bacterium is associated with cereals like rice, sorghum, maize, cumbu, ragi, tenai and other minor millets and also for cotton, sugarcane, oilseeds and fodder grasses. These bacteria colonizing in the roots not only remain on the root surface, but also a sizable proportion of them penetrates into the root tissues and lives in harmony with the plants. They do not, however, produce any visible nodules or out growth on the root tissue. In the absence of any plant, *azospirillum* live in the soil just like any other micro organism saprophytically, however, when a suitable crop is raised, they are attracted towards the root system, where they colonize and grow in almost a symbiotic manner.

(d) *Azotobacter* - The beneficial effects of *Azotobacter* on plants was associated (non-symbiotically) not only with the process of nitrogen fixation but also with the synthesis of complex of biologically active compounds such as nicotinic acid, pyridoxine, biotin, gibberellins and probably other compounds which stimulate the germination of seeds and accelerate plant growth. *Azotobacter* population in soil or near the root zone of crops (Rhizosphere) is very low when compared to other soil bacteria. The nitrogen fixation potential of this bacterium is also not very high and appreciable (20 to 30 kg of N per ha per year). A fairly high population is required for substantial nitrogen fixation. Enormous energy is required by *Azotobacter* for nitrogen fixation. The possible source of energy for *Azotobacter* is the soil organic matter. The energy generated during the utilization of organic matter is used for nitrogen fixation.

(e) *Blue green algae* - The blue green algae occur under a wide range of environmental conditions. They are completely auto tropic and require light, water, free nitrogen (N₂), carbon dioxide (CO₂) and salts containing the essential mineral elements. They play a major role in the nitrogen economy of paddy soils in tropical countries. Different algal species available are:

- *Tolypothric tenuis*,
- *Nostoc*,
- *Plectonema*,
- *Chlorococcus*,
- *Aulosira fertilization*,
- *Anabaena*, and
- *Chorococcum*

(f) *Phosphobacterium* - In most of the acid and clayey soils, the applied phosphorus either as super phosphate or mussoriphos will not be available to crops due to fixation. It is essential to use the phosphobacteria (a free living bacteria in soils like *Bacillus megatherium*) for proper solubilisation of fixed P and release them in the available form for the crop to take-up for its growth. Dual inoculation of the phosphobacteria with rhizobium or *azospirillum* can provide both N and P to the crop.

(g) *Mycorrhizae (VAM)* - Vesicular Arbuscular Mycorrhiza is a fungi used as bio-fertilizer. The mycorrhizal symbiosis is an intimate association between plant root system and certain group of soil fungi. The plant provides carbon as energy source to the fungus which in turn helps the plant in better uptake of nutrients (especially P). The VAM fungi form either a mantle of hyphae around the root or penetrate inside the roots spreading intra or intercellularly in the cortical region. The fungal mycelium also extends several centimeter, away from the root in the soil. The area that the plant can explore for nutrients thus greatly increase due to colonization of plant roots by the mycorrhizal fungi. The development of mycorrhiza network is much more in soils with low fertility. In nutrient rich soils, there is very little extension of mycelial network. The mycelial growth is confined to the close proximity of roots. Mycorrhiza increases crop yield, protect against certain root pathogen, helps in uptake of P, Cu, Zn and B and increases tolerance to environmental stress.

12.7 FACTORS AFFECTING MANURES AND FERTILIZERS USE

Major factors influencing the selection, quantity, time and method of application of manures and fertilizers are:

Soil factors - They most important factors are, soil physical condition (texture), soil fertility and soil reaction.

- Poor physical condition of the soil leads to poor plant growth due to impeded drainage, restricted aeration and unfavourable soil temperature. In this condition nutrients will not be used efficiency.
- Optimum soil moisture regime is essential for efficient use of fertilizers by crops.
- The availability of nutrients is poor in coarse textured soil when compared to fine textured soils. The coarse textured soil needs more frequent application of fertilizers when compared to heavy textured soil.
- The higher the fertility of soil, the lower is the response to manures and fertilizers.
- When the organic matter of the soil is higher, the response to fertilizer by crops is more.
- Soil reaction is important for selection of right type of fertilizers Rock Phosphate is advantageous in acid soils.

Crop factors

- The response of crop to fertilizers varies with the nature of crop and variety of the crop.
- The fertilizer responsiveness of a plant depends on the cation exchange capacity (CEC) of the roots. The root CEC of dicotyledonous plants is much higher than that of monocotyledonous plants. Plants with higher CEC absorb more of divalent cations (Ca, Mg) whereas plants with low CEC absorb more of monovalent ions (K, Na).
- The ability of the crop to absorb nutrients from the soil depends upon the size of the root system (root length and spread) and characteristics like root surface and root hair density etc. Large ramifying root system absorbs more nutrients.
- The association of mycorrhizal fungi with the roots of plants grown under conditions of low soil fertility, increases the ability of plants to absorb nutrients such as P, K, Cu and Zn. Normally N, P and complete fertilizer application reduce the presence and activity of Mycorrhiza.

Agronomic factors - Fertilizer responsiveness of crops depends on timely sowing, proper spacing, proper dose, time and method of fertilizer application.

Other factors

- **Climatic factors** - Under drought and excess moisture condition, foliar spray can be recommended. In high rainfall area, split application of fertilizers and application of slow release nitrogenous fertilizers are recommended.
- **Yield goal** - The economic yield or potential yield or targeted yield decides the quantity of manures and fertilizers application. For higher crop yield optimum or maximum amount of fertilizers are to be applied.
- **Cost of fertilizers** - Not only the cost of fertilizers and manures but also the cost of together produce decide the quantity of manures and fertilizer to be applied *i.e.*, depend on the profit from the crop. It may be maximum profit or maximum rate of return per rupee invested.
- **Availability of manures and fertilizers** - Timely availability of manures and fertilizers, transport facility and labour for application decides the quantity. Now-a-days, manures are not available to the required level due to various reasons.

Slow release fertilizers - are developed to prevent the loss of nutrients by leaching and nitrification. It releases nutrients slowly and uniformly and increases the fertilizer use efficiency. Examples: Neem coated Urea, Sulphur coated Urea, Lac coated Urea, Tar coated Urea, N-Serve, Isobutylidene di Urea (IBDU), Thiourea etc.

12.8 TIME OF APPLICATION

- **Before preparatory tillage**: Bulky organic manures, green manures, soil amendments and soil conditions are applied before preparatory tillage for thorough mixing with the soil.
- **Basal dressing**: Application of manures and fertilizers before last ploughing/puddling or before sowing or planting.
- **At sowing or planting**: Concentrated organic manures, readily soluble and higher mobile fertilizers, slow release fertilizers, starter dose of N fertilizer to legume crops and fertilizer for specific nutrient deficient soil are applied during this time.
- **Top dressing**: It is the application of manures and fertilizers to the established crop within crop duration. Top dressing may be done to the soil or to the foliage. Split application of nitrogen and potassium is done throughout the cropping period to increase the fertilizer use efficiency.

12.8.1 Method of Application

The choice of method and time of fertilizer application depends on the form and amount of fertilizer, convenience of the farmer, the efficiency and safety of fertilizer application.

I. Solid Form

1. **Broadcasting** - The manures and fertilizers are scattered uniformly over the field before planting the crop and are incorporated by tilling or cultivating.
2. **Drilling and placement** - Fertilizers are placed in the soil furrows formed at the desired depth. Placement can be done by the following ways.
 - (i) **Plough sole placement** - In this method of fertilizers are applied or dropped in the plough sole, which will be covered by the plough during the opening of adjacent furrow.
 - (ii) **Deep placement** - Fertilizers or manures are placed at the bottom of the top soil at a depth of 10-12 cm, especially in the puddle rice soil.
 - (iii) **Sub soil application** - Fertilizers are applied in the subsoil especially for tree crops and orchard crops at a depth above 15 cm.

3. **Location or spot application** - Fertilizers are placed in the root zone or the spot near the roots from which roots can absorb easily.
- (i) **Contact of drill placement** - Fertilizers or manures are placed at the time of drilling for placing the seeds. Fertilizers or manures will have good contact with the seeds or seedlings.
 - (ii) **Band placement** - This is the placement of manures or fertilizers or both in bands on the side or both sides of the row at about 5 cm away from the seed or plant in any direction. Such band placement is of three types.
 - (a) **Hill placement** - In widely spaced crops, like cotton, castor, cucurbits fertilizers or manures are applied on both sides of plants only but not continuously along the row.
 - (b) **Row placement** - In widely spaced crops between rows (Example–Sugarcane, maize, tobacco, potato) manures or fertilizers are placed on one or both sides of the row in continuous bands.
 - (c) **Circular placement** - Application of manures and fertilizers around the hill or the trunk of fruit tree crops in the active root zone.
 - (iii) **Pocket placement** - Application of fertilizers deep in soil to increase its efficiency Especially for the sugarcane pocket placement is done. Fertilizers are put in 2 to 3 pockets opened around every hill by means of a sharp stick.
 - (iv) **Side dressing** - It refers to hill and ring placement of manures or fertilizers. It consists of spreading the fertilizer between the rows or around the plants.
 - (v) **Pellet application** - Nitrogen fertilizers are pelleted like mud ball or urea super granules (USG) and placed deep (10 cm) into the saturated soils (reduced zone) of wet land rice to avoid nitrogen loss from applied fertilizers.

Generally placement of fertilizer is done for three reasons.

- Efficient use of plant nutrients from plant emergence to maturity.
- To avoid the fixation of phosphate in acid soils.
- Convenience to the grower.

II. Liquid form

Foliar application: It refers to spraying of fertilizer solution on the foliage of plants for quick recovery from the deficiency (either N or S).

Fertigation: It is the application of fertilizer dissolved in irrigation water in either open or closed system *i.e.*, lined or unlined open ditches and sprinkler or trickle systems respectively.

Starter solutions: They are solutions of fertilizers prepared in low concentrations which are used for soaking seeds, dipping roots, spraying on seedlings etc., nutrient deficient areas for early establishment and growth.

Direct application to the soil: Liquid fertilizers like anhydrous ammonia are applied directly to the soil with special injecting equipments. Liquid manures such as urine, sewage water and cattle shed washing are directly let into the field.

12.9 INTEGRATED NUTRIENT MANAGEMENT (INM)

Judicious combination of inorganic, organic and bio-fertilizers which replenishes the soil nutrients removed by the crops is referred as integrated nutrient management system.

A. Concept

The concept of INM is to integrate the nutrient sources and methods of organic and inorganic nutrient

application to maintain soil fertility and productivity *i.e.*, the complementary use of chemical fertilizers, organic manures and bio-fertilizers to solve the problems of nutrient supply, soil productivity and environment. Developing an INM system for a particular crop sequence to a specific location requires a thorough understanding of (i) the effects of previous crop, (ii) contribution of legume in the cropping system, (iii) residual effect of fertilizers, and (iv) direct, residual and cumulative effect of organic manures for supplementing and complementing the use of chemical fertilizers.

The main components of the N supply system are the organic manures green manures, crop residues, crop rotation and inter cropping involving legumes and cereals, bio-fertilizers including rhizobium, azotobacter, azospirillum, phosphorus solubilizing micro-organisms like mycorrhizal fungi, azolla, blue green algae and cyanobacteria. All these can serve as an important supplementary source of nutrients along with the chemical fertilizers. Thus, INM is environmentally non-degradable, technically appropriate economically viable and socially acceptable.

Balanced nutrition for sustainable crop production

The rate of growth of agriculture in its broad coverage of crop production is much below the national growth rate. If the economy of country is to be improved through agriculture, it has to strengthen its programmes in such a manner to better utilize the natural resources along with balanced use of chemical fertilizers and other inputs. For increasing the food production to fulfill the food requirements of the burgeoning population of the country, sustainability of agriculture and environmental safety are the priority issues. To avoid wastage of precious national resources and to minimize the environmental damage, there is need to develop and demonstrate balanced use of chemical fertilizer. This will not only improve the crop production in sustainable way but also economize the crop production. Higher food production needs higher amount of plant nutrients. As no single source is capable of supplying the required amount of nutrients, integrated use of all sources is a must to supply balanced nutrition to plants.

What is balanced nutrition?

Balanced fertilization does not mean a certain definite proportion of N, P and K or other nutrients to be added in the form of fertilizer, but it has to taken into account the availability of nutrients already present in the soil, crop requirement and other factors like crop removal of nutrients, the economics of fertilizers and profitability, farmers ability to invest, agro-techniques, soil moisture regime, weed control, plant protection, seed rate, sowing time, soil salinity, alkalinity, physical environment, microbiological condition of the soil, available nutrient status of soil, cropping sequence, etc. It is not a state but a dynamic concept. The balanced use of fertilizers should be mainly aimed at: (a) increasing crop yield, (b) increasing crop quality, (c) increasing farm income, (d) correction of inherent soil nutrient deficiencies, (e) maintaining or improving lasting soil fertility, (f) avoiding damage to the environment, and (g) restoring fertility and productivity of the land that has been degraded by wrong and exploitative activities in the past. Balanced use of plant nutrients corrects nutrient deficiency, improves soil fertility, increases nutrient and water use efficiency, enhances crop yields and farmer's income, improves crop and environmental quality. To reap the benefits of balanced use of plant nutrients, it is important to have good quality seed, adequate moisture and better agronomic practices with greater emphasis on timeliness and precision in farm operations.

Soil testing is one of the most important tools to practice balanced fertilization. Balanced fertilizer rates differ from area to area and also from crop to crop. Through soil testing, farmers can know how much and what kind of fertilizer to use for each crop. A further refinement in fertilizer dose is possible

on the basis of type of crop and its variety, water availability and its quality, availability of organic manures, crop residues, biofertilizers, etc.

Since the initiation of green revolution in late sixties, India has made a remarkable progress in fertilizer nutrient use with the introduction of high yielding varieties of wheat and rice. Crop production under intensified agriculture over the years has resulted in large scale removal of nutrients from the soil, resulting in negative balance and declining soil fertility. *Organic sources* are undoubtedly an important source of nutrients but their amounts and available nutrient content and the release rate is woefully inadequate for meeting the demands of intensive and high yielding crop production. India is presently using 15 m.t. of nutrients in the form of chemical fertilizers. Supplying the same through organic sources would require more than a thousand m.t., which is an impossible task indeed. Such organic manures in monumental volumes are neither available nor can be generated. Thus organic sources of nutrients can only be relied upon on meeting parts of the nutrients needs of the crop. They should be added along with chemical fertilizers for ensuring stability and sustainability of food production. In India, fertilizer consumption increased from less than 50,000 t in 1950 to 15 m.t. in 2000 and the food grain production increased from 50 m.t. to 200 mt in the same period, indicating a direct relationship between the fertilizer use and yield increase. The green revolution or spectacular increase in production would not have been possible without many fold increase in use of fertilizers. The high yielding varieties became a catalyst for the conversion of chemical energy into biological productivity. The full potential of these varieties were not yet realized. Even the optimum potential of available technology remains mostly unrealized in most regions as nutrient input does not match the needs of the crop and soil.

There are vast differences in consumption of fertilizers per ha of cropped area in different regions. The fertilizer consumption varies from 114, 103, 58, 47 kg (NPK) per ha cropped area in north, south, east and west respectively. Some states like Punjab are using more than 167 kg nutrients per ha as against some using less than 10 kg nutrients per ha. About 70–80 per cent fertilizer is used for growing rice and wheat. Besides these the major recipients of the remaining fertilizer use are sugarcane, cotton, potato, plantation and horticulture crops. The lowest fertilizer use is in rainfed farming, which covers nearly 66 per cent of the total cropped area in the country. It hardly needs to be stressed that in these rainfed areas more from deficiency than moisture inadequacy. But the later is more appreciated than the former. There are also wide differences in the consumption ratio of three major nutrients $N:P_2O_5:K_2O$ in different regions, crops and cropping systems. These differences also got magnified and showed aberrations due to adhoc changes in pricing policy of fertilizers during the recent years. This and the NPK ratio for India changed from 5.9:2.4:1.0 in 1991-92 to 9.7:2.9:1.0 in 1993-94. There is also divergence in ratios in different regions. While the ratio in 1995-96 was 41.4:8.5: 1.0 in northern states and 3.8:1.4:1.0 in southern states. Such divergence in new ratio is also due to the differences in the quality of land, inherent soil fertility, cropping systems and degree of exploitive agriculture.

Soil test summarizes indicate that 98 per cent Indian soils have low to medium available P and 60 per cent medium K status whereas, N continues to be universally deficient. 47 per cent soils are deficient in Zn, 12 per cent Cu and 4 per cent in Mn. In some states and crops, the deficiency of B and Mo are also becoming limiting factors for crop production. In recent years, a phenomenal increase in S deficiency has been witnessed specially under intensive cropping system where high analysis fertilizers devoid of S are used. The S deficiency is more pronounced in crops like oil seeds, legumes and intensively fertilized rice and wheat. In fact, the spectrum of S deficiency is increasing so rapidly that in future, it will become one of the major yield limiting factors. It is said that the planners are more concerned with the yield barriers of some high yielding varieties but do not seem to be concerned with

the rapidly changing scenario of plant nutrient deficiency and the pivotal role of fertilizers in food security. Thus in a situation where besides NPK, the nutrients such as Zn, Fe, Mn, Cu, B and S are also becoming limiting factors. It is unthinkable to have a sustained food security without balanced and integrated use of nutrients from external sources. The spectrum of nutrient deficiency is becoming more apparent under areas of intensive cropping systems which are the main contributors of National food stock of Food Corporation of India. There are signs of yield stagnation and low responses to fertilizers and other inputs because of imbalanced fertilizer use.

Nitrogen no doubt is the most limiting factor for Indian agriculture, but nitrogen alone is not enough and fertilizer does not mean nitrogen fertilizers only. Lack of this appreciation has led to poor results in most cases. Improving N use efficiency is the major problem for improving economy of its use especially in rice growing areas. Green manuring with legumes and other means of biological nitrogen fixations such as through BGA, Azolla, etc., can contribute to some of the N needs of rice crop but there are numerous technological, economic and operational problems to their use. At best, they can be relied upon for 30-60 kg supply under good management. The efficiency of use of biofertilizers is more crop specific, location specific and management specific and unless, there is a reliable system of quality control and a good system of storage, transportation and management in the field, the expected contribution will not be realized. No doubt the awareness of balanced use of fertilizers is growing, but enormously wide N:P:K ratio are a matter of great concern. It is amazing that NPK ratios in Haryana during 1995-96 was 186:42:1 as against 64:14:1 in Punjab and 1.9:0.6: 1 in Tamil Nadu as against 8.9:2.8:1 in whole of India. Bringing this ratio closer to the desirable ratio of 4:2:1 for cereals is essential for maximizing the efficiency of fertilizers. The situation of P and K is more worrisome in India. The declining use efficiency of fertilizers and of soil productivity is other matters of concern. This fatiguing effect is more prominent in frontier states of green revolution such as Punjab, Haryana, Uttar Pradesh and other intensively cropped areas of the country. It has been estimated that annually we are robbing the soil of more nutrients in the form of biomass than returning to it in the form of fertilizer and manures. The annual negative balance seems to be of the order of about 10 m.t. of NPK. It will become manifold when we attempt doubling the productivity and production. If this nutrient drain continues, the sustained high productivity and sustainability of agriculture will be an impossible task.

India is adding every year population to one Australia and New Zealand and it is estimated that by 2025, the population of the country will touch 1.4 billion mark. For feeding such a large population, India may need about 300 million tones of food grains annually. It may require 35-45 m.t. of nutrients from both organic and inorganic sources of fertilizers. Besides these, it will also need thousand tones of Zn, Fe, Mn, Cu and B. It is not only the huge amounts of fertilizer nutrients which matters but also the use efficiency and management system which will determine their economics or benefit/cost ratio is equally important. Thus the key to future national food security and national security lies in balanced and integrated supply and management system, and there is no alternative to it. Balanced fertilizer use is also necessary to improve the economics or profitability of fertilizer use which provides incentive to farmer for its efficient use. It also improves the quality of the produce which is very much in demand for the export market as well as for home market. It hardly needs to be stressed that many wrong notions about fertilizer use spoiling the soil quality are related to imbalanced and imprudent use of nitrogenous fertilizers only.

No single source of plant nutrient, whether it is chemical fertilizer or organic manure or green manure or biofertilizer or crop residue is in a position to meet the growing crop nutrient need. Moreover, the right kind of nutrients required by the crop crops may not be achieved from a single source. For example, different chemical fertilizers can supply the nutrients like N, P, K, Zn and S; Green manuring use can meet a part of N requirement, one t organic manure can add about 12 kg NPK and also some

micronutrients; crop residue like rice straw is a good source of potassium and use of biofertilizers can supply nitrogen @ 20-25 kg/ha and mobilize soil phosphorus. This implies that integrated use of plant nutrients is essential mainly for two obvious reasons: (i) to increase nutrient supply, and (ii) practice balanced fertilization. In addition integrated use of different sources of plant nutrient helps to increase their efficiencies and also crop productivity.

Efforts should be made to educate farmers to practice balanced use of fertilizers. Of late, some fertilizer companies and associations have come forward to educate the villagers, publication of literature in regional languages related to balanced use of fertilizers for higher crop yields in a sustainable way. The actual time has come; the farmers, researchers and other related communities should come forward and act in this respect. The chemical fertilizers should be used judiciously and use manures along with chemical fertilizers for improving the crop yield and soil productivity in a sustainable way.

Dry Land Agriculture

13.1 INTRODUCTION

Growing of crops entirely under rainfed conditions is known as dry land agriculture. Depending on the amount of rainfall received, dry land agriculture can be grouped into three categories *viz.*, 1. Dry farming, 2. Dry land farming, and 3. Rainfed farming.

Dry farming is cultivation of crops in regions with annual rainfall of less than 750 mm. Crop failure is most common due to prolonged dry spells during the crop period. These are arid regions with a growing season (period of adequate soil moisture) of less than 75 days. Moisture conservation practices are necessary for crop production. Emphasis is on soil and water conservation, sustainable crop yields and limited fertilizer use according to soil moisture availability.

Dry land farming is cultivation of crops in regions with annual rainfall of more than 750 mm. In spite of prolonged dry spells, crop failure is relatively less frequent. These are semiarid tracts with a growing period between 75 and 120 days. Moisture conservation practices are necessary for crop production. However, adequate drainage is required especially for vertisols. Main emphasis is on soil and water conservation, sustainable crop yields and limited fertilizer use according to soil moisture availability.

Rainfed farming is crop production in regions with annual rainfall of more than 1150 mm. Crops are not subjected to soil moisture stress during the crop period. These are humid regions with growing

Table 13.1. Distinguishing Features of Dry Land Farming and Rainfed Farming

<i>Constituent</i>	<i>Dry land farming</i>	<i>Rainfed farming</i>
Rainfall (mm)	<800	>800
Moisture availability to the crop	Shortage	Enough
Growing season (days)	<200	>200
Growing regions	Arid and semiarid as well as uplands of sub-humid and humid region	Humid and sub-humid regions
Cropping system	Single crop or intercropping	Intercropping or double cropping
Constraints	Wind and water erosion	Water erosion

period of more than 120 days. Emphasis is on disposal of excess water, maximum crop yield, high levels of inputs and control of water erosion.

UNESCO for Asia and the Pacific distinguished dry land agriculture mainly into two categories: dry land and rainfed farming. The distinguishing features of these two types of farming are given in Table 13.1.

The words “Arid” and “Semiarid” must be understood differentially from dry farming. All the dry farming areas are located in arid and semi arid regions only. But not all the arid and semiarid regions come under dry farming areas. When irrigation facilities are available, irrigated farming is practiced extensively in arid and semiarid regions also. Similarly the two words arid/semiarid and tropical/temperate must be understood correctly. Arid or semiarid refers to moisture regimes where as tropical or temperate refers to thermal (temperature) regimes of an area.

A. Arid Regions of the World

The climate of arid region is characterized by very low rainfall, usually less than 200 mm per year, occurring in a very short period, rainless dry spells, may at times, stretch for more than a year. Depending on temperature regimes and location from the equator, the arid regions are classified into Arid Tropics with mean annual temperature exceeding 18°C and Arid Temperate regions with mean annual temperature less than 18°C. The following are the five arid zones in the world:

1. North African Eurasian–Sahara and Tar desert
2. North American desert–Arizona in USA
3. South American desert–Peru
4. South African desert–Namibia
5. Australian desert–Central Australia

B. Semi Arid Regions of the World

Depending on distance from the equator and temperature regimes, semi arid regions are divided into Semi Arid Tropics, usually termed as SAT regions and semi arid temperate regions.

(a) **Semi arid tropics (SAT):** This region lies between 10° and 30° N and S latitudes. It is spread over 48 countries in four continents of Asia, Australia, America and Africa. It covers many parts in Africa, India, Pakistan and North Eastern Burma in Asia, Northern Australia and Mexico, Paraguay, Bolivia and Venezuela in South America. The total area of SAT is estimated to be 18.9 million square kilometers. West Africa accounts for 24% of semi arid tropics, East Africa 18%, South Africa 20%, Latin America 17%, Australia 10% and South Asia 11%. A semi arid climate is essentially a mixed climate in which a fairly moist or rainy season alternates with a completely dry season. Hence, the climate is described as alternating wet and dry climate. Rainfall occurs during 2-7 months of the year. When number of wet months is 2.0-4.5, it is described as dry SAT and when rainy month ranges from 4.5 to 7.0, it is called as wet SAT. Rainfall quantity ranges from 400-750 mm per year, with a variability of 20-30%. But, the onset, closure and duration of rainy season exhibits wide variability between years. Distribution of rainfall within the season also exhibits wide fluctuations between years. A greater portion of rainfall is received in high intensity over a short duration, leading to run off. Mean annual temperature is more than 18°C and during most months, PET is higher than precipitation. Soil moisture inadequacy is the major constraint for cropping.

(b) **Semi arid temperate region:** It covers in Russia, North Western China, USA and Canada. Though annual rainfall is low, PET also is low during many months. Mean annual temperature is less than

18°C. Maximum temperature during summer is 33°C while minimum temperature may reach -26°C during winter months. Temperature rather than moisture is the critical limiting factor for crop production.

13.2 INDIAN AGRICULTURE - SCENARIO

A. Location

India, a tropical country is located between 8° and 36° N of the equator and between 68° and 96° E longitude.

B. Temperature

The tropic of cancer, which passes through the middle of the country, divides it into two distinct climates. The tropical climate in the South where all the 12 months of the year have mean daily temperature exceeding 20°C; and in the North where a sub-tropical climate prevails. In sub-tropics during the winter months, it is cool to cold. Frosts occur sometime during the months of December and January. Some areas in the Northern India have a temperate climate. Here, it snows during the winter months and freezing temperatures may extend to two months or more during the year.

C. Rainfall

Rainfall in India varies considerably. In some parts of the Thar desert, located in Western Rajasthan, the annual rainfall is as low as 100 mm; while in the East, the annual rainfall may be as high as 10,000 mm or more. In some areas, it may rain for a month or two during the year, in others as many as 11 months may be rainy.

Rainfall aberrations - Deficit in the quantity of rainfall adversely affects crops growth through inadequate supply of moisture. It leads to lower yield and even complete crop failure. High intensity rainfall causes runoff and soil erosion. It reduces the storage of rainfall in the soil. Erratic distribution leads to long dry spells during crop growth and cause moisture stress. High variability in the onset of rainy season affects time of sowing. Delayed onset also affects crop choice. Early withdrawal or cessation of rainfall before the normal time of closure will lead to moisture stress at maturity and reduce crop yield. Dry spells during rainy season affect crop growth depending on length of dry spell, sage of occurrence and soil type. Dry spells over 3 weeks are usually harmful.

<i>Dry spell after sowing</i>	<i>Germination and establishment affected</i>
At vegetative stage	Stem elongation, leaf area expansion and affects dry matter accumulation.
At flowering	Very critical for pollination and affects grain setting.
At ripening	Affects grain development and yield.

Rainfall on crop production: Primary source of water for the earth is precipitation. About 40% of food produced depends on rainfall. The choice of crop and variety depends on rainfall. The crops depend on rainfall for their moisture need. Though rivers, tanks and well can supplement the rainfall, these sources also depend on the rains ultimately. Deficient rains limits crop growth and heavy rains are even more harmful. Occurrence of drought and famines are mainly due to inadequate rainfall over a continuous period of time.

D. Monsoon

India is a monsoonal country. In the tropical and sub-tropical regions, almost 80% of the total annual

rainfall is received during the monsoon-rainy season. There are two types of monsoons received in India. During the main rainy season extending from June/July to September/October, the rains we receive are called as Southwest monsoons. They are called thus, because the rainy season sets in first in the South of India and rains progress gradually towards the West of the country.

- (i) **Onset of monsoon:** At Trivandrum in Kerala State, the south-west monsoon breaks around June 1; at Hyderabad in Andhra Pradesh around June 5; at Mumbai around June 10; and at Jaipur or Jodhpur towards end of June or early July. The normal dates of onset are just averages, in actual terms there may be a week or 10 days delay or earliness. These are just guide dates for agricultural operations or crop calendars. The actual dates vary from year to year. North-east monsoons occur due to cyclonic disturbances in the Bay of Bengal. Their normal date of onset is between November 1 and November 15. These rains withdraw by about end of January and occur in areas located below 10°N latitude in India.
- (ii) **Rainfall distribution:** The rainy season extends to about 2-4 months across most of agricultural regions in Northern and North-west India; it extends to 5 months in Peninsular India (*e.g.*, Hyderabad), and is of a much longer duration in some Southern areas (*e.g.*, Bangalore or Trivandrum).
- (iii) **Rainfall climatology:** Study of rainfall over a long period is called rainfall climatology. It reveals general pattern of rainfall of a particular place. It helps in understanding the amount, intensity, distribution and other rainfall characteristics. Rainfall analysis also helps in classification of climate. Suitable and efficient cropping systems can be developed by understanding the rainfall pattern. Rainfall analysis helps in taking decisions on time of sowing, scheduling irrigation, time of harvesting etc. It is necessary for designing farm ponds, tanks or irrigation projects. Amount, distribution and intensity of rainfall are the important aspects of rainfall that have considerable influence on crop production.

Precipitation is water in liquid or solid forms, falling to the earth. It always precedes condensation or sublimation or a combination of the two and is primarily associated with raising air. In the same way, isotherms and isobars are used to show temperature and pressure distribution respectively, isohyets for rainfall distribution. An isohyet is a line connecting points with equal values of rainfall. Change of state from water vapour to liquid water is condensation. When moist air comes in contact with cool surfaces, it may be cooled to the point where its capacity to hold water vapour is exceeded by the actual amount in the air. Part of the water vapour then condenses into liquid form on the cool surface, produce dew. When this happens, the latent heat of vaporization, in this process, called the latent heat of condensation is released. At temperature below freezing, water may bypass the liquid form in its change of state. When dry air with a temperature well below freezing comes in contact with ice, molecules of ice (H₂O) pass directly into the vapour state by the processes of sublimation.

- (iv) **Forms of precipitation:** Condensation forms of fog, dew and frost are not considered to be precipitation. The common precipitation forms are rain, drizzle, snow, sleet and hail. Of these, drizzle and light snow are the only forms likely to fall from clouds having little or no vertical development. Fog results when atmospheric water vapour condenses to water droplets or ice crystals, become visible and will have their base in contact with ground.
- (v) **Types of rainfall based on distribution:** In India, all areas located between 20°N of equator to 40°N, the rainfall is unimodal and almost all of the annual rainfall is received due to South-west monsoons. In South India, the areas located below 10°N, the rainfall is bimodal or it has two peaks—one peak during the South-west rainy season and the second peak in North-east monsoon.

- (vi) **Rainfall quantity:** Generally, yield levels are determined by the amount of precipitation above the basic minimum required to enable the crop to achieve maturity. Though rainfall has major influence on crops yield, yields are not always directly proportional to the amount of precipitation. Rainfall may also be in excess of the optimum and thereby cause reduced yields, which may appear paradoxical to semi-arid climates. When the rainfall is concentrated in 4-5 months of the year, there may be periods when the rate of precipitation exceeds the intake rate of soil. As a result, considerable runoff occurs, plant nutrients are leached out of the root zone and crops are adversely affected by anaerobic conditions (germination, establishment etc.), especially if the excess precipitation occurs during the cool season. It may uproot and wash away young seedlings, causes lodging of grown up crops and affect pollination and seed setting.

Based on the average rainfall over years, the receipt of rainfall during a year is classified by IMD as below:

-19 to + 19%	=	Normal
+20 to + 59%	=	Excess
> + 59%	=	Wet
-20 to -59%	=	Deficit
< -60%	=	Scanty

(vii) **Rainfall analysis**

1. **Intensity of rainfall:** Intensity of rainfall mainly influences soil erosion. Study of rainfall intensity helps in probable period of floods, filling of irrigation tanks etc. If the intensity of rainfall exceeds the rate of soil infiltration, runoff starts. High intensity rainfall causes soil erosion. The runoff from hills and mountain slopes is collected in tanks. The relationship between intensity of rainfall and runoff is given below:

Less than 12.5 mm	-	Runoff is rare
12.5–25.0 mm	-	Runoff in 35% occasions
25.0–50.0 mm	-	Runoff in 80% occasions
Above 50.0 mm	-	Runoff in 100% occasions

2. **Distribution of rainfall:** The amount of rainfall received at periodic intervals like weeks, months, seasons etc. indicates distribution. In addition, distribution of rainfall can be known by the length of dry spells, wet spells and rainy days. Distribution of rainfall is more important than total rainfall. It can be illustrated with following example taking rainfall related indices of Hyderabad and Sholapur.

<i>Index</i>	<i>Hyderabad</i>	<i>Sholapur</i>
Annual rainfall (mm)	764	742
Seasonal rainfall (mm)	580	556
Coefficient of variation (%)	26	28
Potential evapotranspiration (mm)	1757	1802
Growing season (days)	130	148
Soil	Vertisol	Vertisol

It is apparent from the data that annual rainfall is fairly similar at both locations as seasonal rainfall. The rainfall is equally variable and the potential evapotranspiration is fairly similar at

the two locations. The growing season is slightly less at Hyderabad compared to Sholapur. From the above, one could probably anticipate that the production potentials are quite similar. However, rainy season crops are successful at Hyderabad and the annual yields range from 5,000 to 7,000 kg/ha while at Sholapur rainy season crops are risky and annual yields range from 1,000 to 2,000 kg/ha. Low grain yields at Sholapur are mainly due to discontinuous rainfall or long breaks in rainfall during the crop period.

3. **Dependability/reliability of rainfall:** Rainfall in dry farming regions is characterized by high variability and less reliability. The variability occurs in quantity of rainfall, onset and closure of rainy seasons, duration of rainfall and distribution within rainy season. The spatial variability refers to the variability of rainfall between two locations and the temporal variability refers to the variations over time *i.e.*, between years, between seasons and within season. Variability of rainfall is the greatest hazard to crop production in the dry farming regions. The dependability can be estimated by 75 per cent probability rainfall and by coefficient of variation. It indicates that there is 75 per cent probability of receiving a particular amount of rainfall in three years out of four years. It can be estimated by arranging the amount of rainfall present at the three-fourth's place in the descending order line is the 75 per cent probability rainfall.

EXAMPLE

<i>Annual rainfall during different years</i>		<i>Rainfall arranged in descending order</i>	
<i>Years</i>	<i>Amount (mm)</i>	<i>Amount (mm)</i>	<i>Ascending order</i>
1950	850	1020	1
1951	950	950	2
1952	1020	870	3
1953	625	850	4
1954	750	750	5
1955	550	725	6
1956	650	650	7
1957	475	631	8
1958	631	625	9
1959	725	550	10
1960	870	525	11
1962	525	475	12

Out of 12 years, 631 mm and above rainfall was received in eight years and it is the 75 per cent probability rainfall.

Coefficient of Variation (CV%): By calculating coefficient of variation, the variation in rainfall can be quantified. If the CV is more, it means that variation in rainfall from year to year or season-to-season is more. If the CV is less, the variation in rainfall is less and it is more dependable.

$$\text{Coefficient of variation} = \frac{\text{Standard deviation}}{\text{Mean}} \times 100$$

$$SD = \sqrt{\frac{\sum x^2 - (\sum x)^2/n}{n-1}}$$

Dependability of rainfall based on CV

<i>Period</i>	<i>Dependable</i>	<i>Not dependable</i>
Annual	25%	> 25%
Seasonal	50%	> 50%
Monthly	100%	> 100%
Weekly	150%	> 150%
Daily	250%	> 250%

13.3 DRY FARMING IN INDIA

About 70% of rural population lives in dry farming areas and their livelihood depend on success or failure of the crops. Much of the increase in food production in the recent past is estimated to be mainly due to irrigated areas. Since 1950, the extent of irrigated land in the world has increased from 94 m.ha to about 220 m.ha. During the 1980s, however, the rate of irrigation development has dropped materially and is presently less than 1 per cent per year, whereas the world population is increasing at 1.7 per cent per annum. Irrigated land accounts for 18 per cent of the cultivated land but produces 33 per cent of the food. The cost of irrigation and drainage development of new systems averages over \$5,000 per ha and can be as high as \$10,000. Therefore, it is inevitable that in future, the additional food has to come mainly from the dry lands. With the current pace of irrigation development, it is assumed that the gross irrigated area is likely to increase to 75×10^6 ha and more than 55 per cent of the gross cropped area will continue to be farmed under rainfed conditions. In India, nearly 43 m.ha out of 143 m.ha of the cultivated area was irrigated, leaving the remaining 100 m.ha as rainfed. According to experts, even when the ultimate irrigation potential is reached, 55 per cent of the net sown area will be still, rainfed. The contribution (production) of rainfed agriculture in India is about 45 per cent of the total food grain, 75 per cent of oilseeds, 90 per cent of pulses and about 70 per cent of cotton. In the 21st century, the contribution of dry lands will have to be 60 per cent if India is to provide adequate food to 1090 m people. Hence, tremendous efforts both in the development and research fronts are essential to achieve this target. More than 90 per cent of the area under sorghum, groundnut, and pulses is rainfed. In case of maize and chickpea, 82-85 per cent area is rainfed. Even 78 per cent of cotton area is rainfed. In case of rapeseed/mustard, about 66 per cent of the area is rainfed. Interestingly, but not surprisingly, 62, 44, and 35 per cent area under rice, barley and wheat, respectively, is rainfed.

Although, India is blessed with average annual rainfall of about 1200 mm, slightly above the global mean of 990 mm, the fate of dry land crops oscillates with the quantity, onset, and progress, spatial and temporal distribution of monsoon rains. Of the mean annual rainfall, 30 per cent of the country gets less than 750 mm and 40 per cent between 750 and 1250 mm. Only 20 per cent area is blessed with rainfall between 1250 and 2000 mm, leaving about 10 per cent area with annual rainfall over 2000 mm. A critical appraisal of the existing rainwater availability shows that:

- India receives 400 M ha m of rain water annually,
- About 160 M ha m falls on agricultural land,
- Nearly 24 M ha m is available for harvesting in small scale water harvesting structures,

- About 186 M ha m goes to rivers as runoff, and
- Around one-fourth of the total annual rainfall is received before or after cropping season.

At present, 3 ha of dry land crop produce cereal grain equivalent to that produced in 1 ha irrigated crop. There is a scope for doubling the average yield of dry land crops. Improvements in the productivity of dry land crops are largely indiscernible. With limited scope for increasing the area under plough, only option left is to increase the productivity with the modern technology and inputs, since the per capita land availability, which was 0.28 ha in 1990, is expected to decline 0.17–0.19 ha in 2010.

The productivity of grains already showed a plateau in irrigated agriculture due to problems related to nutrient exhaustion, salinity build up and raising water table. Therefore, the challenges of the present millennium would be to produce more from less of dry lands while ensuring conservation of existing resources. Hence, new strategies would have to be evolved which would make the fragile dry land ecosystems more productive as well as sustainable. In order to achieve evergreen revolution, we shall have to make **grey areas (dry lands)** as green through latest technological innovations. Dry land offers good scope for development of Agro forestry, Social forestry, Horti-Sylvi-pasture and such other similar systems which will not only supply food, fuel to the village people and fodder to the cattle but forms a suitable vegetative cover for ecological maintenance.

A. Development

- 1920 Scarcity tract development given importance by the RCA
- 1923 Establishing Dry land Research Station at Manjri (Pune) Tamhane to Kanikar 1926
- 1933 Research Stations established at Bijapur and Solapur
- 1934 Research Stations established at Hagari and Raichur
- 1935 Research Stations established at Rohtak (Punjab)
- 1942 Bombay Land Development Act passed
- 1944 Monograph on dry farming in India by N.V. Kanitkar (Bombay, Hyderabad, Madras Dry Farming Practices)
- 1953 Establishment of Central Soil Conservation Board
- 1955 Dry Farming Demonstration Centres started
- 1970 Establishment of 23 Research Centres under AICRPDA
- 1972 Establishment of ICRISAT
- 1976 Establishment of Dry land Operational Research Projects
- 1983 Starting of 47 model watersheds under ICAR
- 1984 Initiation of World Bank Assisted Watershed Development Programmes in four states. Establishing Dry land Development Board in Karnataka
- 1985 Birth of Central Research Institute for Dry land Agriculture at Hyderabad
- 1986 Launching of NWDPRAs programmes by Government of India in 15 states.

B. Factors Affecting Dry Farming

Most of the cropping in the arid and semi arid regions continues to be under rainfed conditions. A majority of the farmers are small farmers with meager resources. The poor resources base permits only

low input subsistence farming with low and unstable crop yields. The low productivity of agriculture in dry farming regions is due to the cumulative effect of many constraints for crop production. The constraints can be broadly grouped into:

- Climatic constraints,
- Soil related constraints,
- Cultivation practices, and
- Socio economic and political constraints.

I. Climatic constraints

- High atmospheric temperature
 - Low relative humidity
 - Hot dry winds
 - High atmospheric water demand (potential evapotranspiration) exceeding precipitation during most part of the year
 - Vagaries of monsoon.
- (i) **Variable rainfall** - Annual rainfall varies greatly from year to year and naturally its coefficient of variation. Generally, higher the rainfall less is the coefficient of variation. In other words, crop failures due to uncertain rains are more frequent in regions with lesser rainfall.
- (ii) **Intensity and distribution** - In general, more than 50 per cent of total rainfall is usually received in 3–5 rainy days. Such intensive rainfall results in substantial loss of water due to surface runoff. This process also accelerates soil erosion. Distribution of rainfall during the crop-growing season is more important than total rainfall in dry land agriculture.
- (iii) **Late onset of monsoon** - If the onset of monsoon is delayed, crops/varieties recommended to the region cannot be sown in time. Delayed sowing lead to uneconomical crop yields.
- (iv) **Early withdrawal of monsoon** - This situation is equally or more dangerous than late onset of monsoon. Rainy season crops will be subjected to terminal stress leading to poor yields. Similarly, post-rainy season crops fail due to inadequate available soil moisture, especially during reproductive and maturity phases.
- (v) **Prolonged dry spells** - Breaks of monsoon for 7–10 days may not be a serious concern. Breaks of more than 15 days duration especially at critical stages for soil moisture stress leads to reduction in yield. Drought due to break in monsoon may adversely affect the crops in shallow soils than in deep soils.

II. Soil constraints

The soil constraints are: 1. Inadequate soil moisture availability, 2. Poor organic matter content, 3. Poor soil fertility, and 4. Soil deterioration due to erosion (wind, water).

III. Cultivation practices

The existing management practices adopted by the farmers are evolved based on long-term experience by the farmers. The analysis of traditional system revealed that on one hand, the traditional system suffers due to the fact that yield levels are low and unstable, while on the other hand, it has strong points due to which it has stood the test of time. The traditional management practices are listed below:

- Ploughing with country plough which is replaced by tractor, ploughing just prior to sowing
- Ploughing along the slope

- Broadcasting seeds/*gorru* sowing/sowing behind the country plough leading to poor as well as uneven plants stand
- Selection of traditional varieties
- Monsoon sowing
- Choice of crop based on rainfall
- Application FYM in limited quantity
- Hand weeding
- Mixed cropping
- Use of conventional system of harvesting, and
- Traditional storage system.

Among the traditional management practices, the following practices are technically sound and can be practiced (strength).

- **Monsoon sowing:** This still holds good for crops like maize, red gram, bajra and karunganni cotton.
- **Choice of crop based on rainfall:** Farmers take up coriander for late onset of monsoon. This traditional practice has been experimentally proved to be correct.
- **Hand weeding:** It has proved to be as effective as herbicide application in terms of weed control and yield.
- **Mixed cropping:** Farmers adopt many mixed cropping systems based on their experience. Groundnut and red gram are sown in 6:1 ratio. Sorghum black gram, green gram and Lab-Lab (mochai) crops are broadcasted. Cotton + black gram is sown in 6:1 ratio or black gram is sown in border. Even though the yield is less, there is some stability in yield due to mixed cropping and it is an insurance against risk of complete failure.
- Traditional system of harvesting processing consumes more labourers, but it can be followed because of no loss in grain during the process of harvest.
- Traditional storage is based on sound practical knowledge as well as it involves low cost technology
- In certain pockets, pre monsoon sowing or early sowing of crops are taken.
- Inter cultivation with plough in between crop rows is one of the best *insitu* soil moisture conservation techniques.

Weakness in traditional system - Most management practices are not aimed at soil moisture conservation. Traditional system does not build up nutrient status in the soil; on the contrary it depletes the fertility status. Genotypes/varieties used are poor yielders. Spatial and temporal variations are not effectively utilized in the mixed cropping adopted by the farmers. This results in no yield advantage. One of the most serious limitations due to traditional management practices is low plant population per unit area, which ultimately reduces yield. Run off is neither collected nor used efficiently.

IV. Socio-economic constraints

Arid and Semiarid Regions of India

Total area under arid and semiarid regions in India extends over 135.8 m.ha. (Table 13.1).

Temperature in arid and semiarid temperate region is maximum at 32°C in July and minimum at -14°C in January–February. Temperature in arid and semiarid tropics is maximum at 40–42°C in May and minimum varies from 3–5°C in Punjab and Haryana and 18–24°C in Tamil Nadu.

Table 13.1. Arid and Semiarid Regions of India

<i>Climate</i>	<i>Area (m.ha)</i>	<i>Regions</i>
Arid Tropics	31.7	Rajasthan, Gujarat, Punjab, Haryana, Parts of Karnataka and Andhra
Arid Temperate	7.0	Jammu and Kashmir
Semiarid Tropics (SAT)	95.7	Maharashtra, Karnataka, Andhra, Rajasthan, Tamil Nadu, Gujarat, Punjab, Haryana, Uttar Pradesh, Madya Pradesh
Semiarid Temperate	1.4	Jammu and Kashmir

Table 13.2. Moisture and Thermal Regime for different Climate

<i>Climate</i>	<i>Moisture regime</i>	<i>Thermal regime</i>	<i>Constraints for cropping</i>
Arid Tropics	Dry	Above 18°C	Moisture
Arid Temperate	Dry	Below 18°C	Moisture and Temperature
Semiarid tropics	Wet-Dry	Above 18°C	Moisture
Semiarid temperate	Wet-Dry	Below 18°C	Temperature

The distribution of arid and semiarid regions of India is given in Table 13.3. Dry farming regions of India and Tamil Nadu are given in Table 13.4 and 13.5.

Table 13.3. Distribution of Arid and Semiarid Regions of India

<i>State</i>	<i>Arid</i>		<i>Semiarid</i>	
	<i>Area (Sq km)</i>	<i>% to total area in India</i>	<i>Area (sq. km)</i>	<i>% to total area in India</i>
A. Tropics				
Rajasthan	196150	61	121020	13
Gujarat	62180	20	90520	9
Punjab	14510	5	31770	3
Haryana	12840	4	26880	3
Uttar Pradesh	–	–	64230	7
Madhya Pradesh	–	–	59470	6
Maharashtra	1290	0.4	189580	19
Karnataka	8570	3	139360	15
Andhra Pradesh	21550	7	138670	15
Tamil Nadu	–	–	95250	10
All India	317090		956750	
B. Temperate				
Jammu & Kashmir	70300		13780	

Table 13.4. Dry Farming Regions of India

<i>Region</i>	<i>States</i>	<i>Places</i>	<i>Rainfall</i>	<i>Monsoon</i>	<i>Climate</i>	<i>Soils</i>	<i>Crops/Cropping systems</i>
Jhansi	Uttar Pradesh	Jhansi, Hamirpur, Banda, Lalitpur, Jalaun	930	Jun-Sep (196)	Semi arid	Red black	Sorghum-safflower/mustard cowpea /urd/moong,-gram safflower rice-soybean-gram safflower
Rajkot	Gujarat	Rajkot Surendranagar, Jamnagar, Junagadh Bhavanagar, Amreli	625	Jun-Sep (134)	Arid	Medium black	Sorghum/bajra/cotton green gram/black gram red gram/cluster bean/groundnut/sesamum/castor-safflower/sunflower/green gram/mustard.
Akola	Maharashtra	Akola, Amravati, Wardha, Yeotmal Parbhani, Buldana, Khandesh, Adilabad, Nizambad	830	Jun-Sep (196)	Semi arid	Medium and deep black	Green gram/sorghum/safflower/sunflower/cotton + green gram/groundnut-sorghum + green gram/black gram/red gram groundnut + sunflower
Sholapur	Andhra Pradesh Maharashtra	Solapur, Ahmednagar, Nasik, Pune, Satara, Sangli, Dhule, Bhir, Osmanabad, Jalgaon, Buldhana	722	May-Oct (68)	Semi arid	Black	Pear millet-Gram/Black gram-sorghum/ Pearl millet + Red gram/Horse gram/ Red gram + setaria/Groundnut/sunflower/Castor-Horse gram
Indore	Madhya Pradesh	Indore, Ratlam, Ujjain Dewar, Dhar, Khargaon Khandura	990	May-Sep (196)	Semi arid	Medium deep black	Maize-gram/safflower sorghum + soybean-gram (safflower-maize + groundnut sorghum + red gram)
Rewa	Madhya Pradesh	Sidlu, Rewa, Satna, Shadol, Panna, Jabalpur, Damoh Chattarpur, Tikamgarh	1080	Jun-Sep (196)	Sub humid	Medium black mixed red and black	Sorghum + Red gram-gram/rice-wheat/gram Black grim Green gram-wheat/rice-lentil
Bijapur	Maharashtra	Bijapur, Gulbarga Belgram,	680	May-Oct (105)	Semi arid	Medium and deep black	Green gram-sorghum/safflower-groundnut/ pearl millet + red gram. Bengal gram+ safflower/cotton
	Karnataka	Raichur					

(Contd.)

<i>Region</i>	<i>States</i>	<i>Places</i>	<i>Rainfall</i>	<i>Monsoon</i>	<i>Climate</i>	<i>Soils</i>	<i>Crops/Cropping systems</i>
Udaipur	Rajasthan	Uddipur, Chittorgarh Bhilwara, Ajmer, Banswara, Dungarpur	635	Jun-Sep (196)	Semi arid	Medium black	Sorghum maize-safflower mustard /pearl millet/pearl millet + cowpea – mustard/Sorghum-mustard. Red gram /green gram/groundnut/Sunflower- wheat/mustard
Bellary	Karnataka	Chellakere, Chitradurga, Bellary, Raichur	500	Sep-Oct (105)	Semi arid	Medium and deep black	Sorghum/safflower/gram sorghum + lablab
	Andhra Pradesh	Anantapur, Kurnool, Mahboobnagar					
Kovilpatti	Tamil Nadu	Tirunelveli, Thoothukudi	730	Sep-Dec (135)	Semi arid	Deep black	Sorghum + cowpea/Pearl millet/ Setaria/kudiraivali/black gram/green gram/Red gram/lablab/cowpea/ cotton +black gram Sunflower/Senna
Agra	Uttar Pradesh	Agra, Aligarh, Mathura, Etah, Manipuri	710	Jun-Sep (187)	Semi arid	Deep alluvial sandy loam	Pearl millet/black gram/green gram/ red gram/cluster bean/groundnut safflower/mustard/pearl millet + red gram/black gram/green gram/ groundnut + castor
Anantapur	Andhra Pradesh	Anantapur, Karnool, Chithoor	570	May-Oct (120)	Arid	Red loam	Pearl millet/sorghum/setaria/castor/ Red gram/groundnut/mesta/groundnut + Red gram/castor/pearl millet + Red gram/castor
Hyderabad	Andhra Pradesh	Rangareddy Nalgonda, Medak, Karimnagar, Mahboobnagar, Warangal	770	Jun-Oct (208)	Semi arid	Shallow red sandy loam	Sorghum/pearl millet/castor/red gram/ ragi/setaria/niger/horse gram/ sorghum/maize + red gram-safflower

Table 13.5. Dry farming regions of Tamil Nadu

<i>Region</i>	<i>Taluk/District</i>	<i>Annual rainfall (mm)</i>	<i>Monsoon</i>	<i>Climate</i>	<i>Soils</i>	<i>Crops/Cropping systems</i>
Northwest	Dharmapuri Dt., Taluks of Omalur,	844	Jun-Oct	Semiarid	Red	Groundnut + Red gram/Castor–Horse gram
	Attur, Rasipuram, Sankagiri in Salem Dt. Perambalur Taluk	842	Jun-Oct	Semiarid	Red	Cowpea - sorghum/Sorghum + lablab red gram
	Parts of Tirupattur and Vellore Taluks	900	Jun-Oct	Semiarid	Red	Ragi/pearl millet/Samai-horse gram
Western	Palladam, Kangeyam, Dharapuram Udumalpet, Coimbatore taluks of Coimbatore and Erode Districts	711 717	Sep-Nov	Semiarid	Red Black	Cotton/sorghum/pear millet/bengal gram/ coriander/sorghum + lablab/red gram
East central	Parts of Tiruchy, Pudukkottai, Madurai and Dindugal Dts.	840 918 876	Sep-Nov	Semiarid	Black Red	Cotton/sorghum/pearl millet/ sesamum sorghum/pulses/pearl millet/ groundnut +red gram/castor
Southern	Tirunelveli Dt.	940	Oct-Dec	Semiarid	Red	Groundnut/cowpea/sesamum sorghum/ pearl millet/pulses castor
	Thoothukudi Dt.	677	Oct-Dec	Semiarid	Black Red	Cotton/chillies/coriander/black gram/sorghum/ pearl millet/pulses.
	Virudunagar Dt.	817	Oct-Dec	Semiarid	Black	Cotton/sunflower/maize/sorghum/pearl millet/ pulses/castor
	Ramanathapuram Dt. Sivagangai Dt.	819 910	Oct-Dec Oct-Dec	Semiarid Semiarid	Black Red	Rice/cotton/sorghum/pulses/chillies Groundnut/pearl millet/sesamum/ cowpea/redgram/castor

13.4 ARIDITY AND DROUGHT

Low rainfall or failure of monsoon rain is a recurring feature in India. This has been responsible for droughts and famines. The word drought generally denotes scarcity of water in a region. Though, aridity and drought are due to insufficient water, aridity is a permanent climatic feature and is the culmination of a number of long-term processes. However, drought is a temporary condition that occurs for a short period due to deficient precipitation for vegetation, river flow, water supply and human consumption. Drought is due to anomaly in atmospheric circulation. The difference between aridity and drought is given in Table 13.6.

Table 13.6. Aridity and Drought

<i>Particulars</i>	<i>Aridity</i>	<i>Drought</i>
Duration	Permanent feature	Temporary condition of scarcity of varying duration
Factors	Culmination of many long term processes considers all climatic features	Caused by deficient rainfall
Aspect described	Description of climate	Description of water availability

A. Aridity

Aridity refers to a condition of deficiency of water due to either insufficient precipitation or excess water loss over supply. The term “arid” is derived from a Latin word, “arere” which means ‘dry’. Assessment of the degree of aridity of a place is necessary to serve as a base for the application of technology, for the interpretation of resource assessment and for transfer of technology. It is also useful to analyze the climatic resources and to identify specific climatic constraints for planning agricultural development. The degree of aridity can be assessed from climatic parameters and plant criteria. Some important indices related to aridity are given below.

Indices of Aridity:

1. Thornthwaite and Mather (1955): The classification of Thornthwaite (1948) was modified for the Moisture Index (I_m) and is given below:

$$I_m = 100 [(P-PE)/PE]$$

where, P = Precipitation,

PE = Potential evapotranspiration

<i>I_m Quantity</i>	<i>Climate classification</i>
100 and above	Per humid
20–100	Humid
0–20	Moist sub humid
–33.3–0	Dry sub humid
–66.7 to –33.3	Semi arid
–100 to –66.7	Arid

2. Troll (1965): Based on thermal and hygric variables and number of humid months, climate is classified and said to be of agricultural use. Humid month is one having mean rainfall exceeding the mean potential evapotranspiration.

<i>Humid months</i>	<i>Climate classification</i>
12.0–9.5	Tropical rainforest
9.5–7.0	Humid Savannah
7.0–4.5	Dry Savannah (Wet–dry SAT)
4.5–2.0	Thorn Savannah (Dry SAT)
2.0–1.0	Semi desert (Arid)
1.0–0.0	Desert (Arid)

3. Papadakis (1961): Moisture Index (H) based on precipitation, soil moisture storage and PET was developed.

$$H = [P + W]/E$$

Where,

P = Monthly precipitation

E = Monthly PET

W = Water stored from previous rainfall

<i>H value</i>	<i>Climate</i>
Less than 0.25	Arid
0.25 to 0.50	Dry
0.50 to 0.75	Intermediate
0.75 to 1.00	Intermediate humid
1.00 to 2.00	Humid
More than 2.00	Wet

4. Hargreaves (1971): Moisture Availability Index (MAI) is used for the classification. It is the ratio of dependable precipitation to potential evapotranspiration. It is a measure of adequacy of precipitation in supplying crop water demand.

$$MAI = \frac{\text{Dependable precipitation (75\% probable rainfall)}}{\text{Potential evapotranspiration}}$$

<i>MAI</i>	<i>Climate classification</i>
0.0–0.33 during all months	Very arid
More than 0.34 for 1–2 months	Arid
More than 0.34 for 3–4 consecutive months	Semi arid

5. Steiner *et al.* (1988): Steiner *et al.* (1988) consider aridity index concept of the United Nations conference on Desertification based on the balance between precipitation (P) and evapotranspiration

(ETP) to be appropriate for wide scale adoption. According to this, the areas with P/ETP ratio between 0.03 and 0.2 are arid and areas with the ratio between 0.2 and 0.5 are semi-arid.

6. FAO classification: FAO classification is based on ‘growing period concept’ . Growing period is the number of days during a year when precipitation exceeds half the potential evapotranspiration, plus a period to use an assumed 100 mm of water from excess precipitation (or less, if not available) stored in the soil profile. Areas having a growing period between 1 and 74 days are classified as arid and those with a growing period between 75 and 119 days are semi-arid.

7. ICAR classification of agroclimatic zones: ICAR while establishing the dry land centers in different agroclimatic zones of the country in 1970, used the simple formula of Thornthwaite (1955) for estimating the moisture index.

$$\text{Moisture Index} = 100 [(P-PE)/PE]$$

Thornthwaite and Mathur (1955) classified only six categories, while the ICAR had eight moisture indices with eight moisture belt indicating eight zones in India. The scale adopted in defining climatic zones in terms of moisture indices are;

<i>Zone</i>	<i>Moisture index</i>	<i>Moisture belt</i>
1	< -80	Extremely dry
2	-60 to -80	Semi dry
3	-40 to -60	Dry
4	-20 to -40	Slightly dry
5	0 to -20	Slightly moist
6	0 to +50	Moist
7	+50 to +100	Wet
8	> +100	Extremely wet

B. Drought

I. Definition

There is no universally accepted definition for drought. Early workers defined drought as prolonged period without rainfall. According to Ramdas (1960), drought is a situation when the actual seasonal rainfall is deficient by more than twice the mean deviation. American Meteorological Society defined drought as a period of abnormally dry weather sufficiently prolonged for lack of water to cause a severe hydrological imbalance in the area affected. Prolonged deficiencies of soil moisture adversely affect crop growth indicating incidence of agricultural drought. It is the result of imbalance between soil moisture and evapotranspiration needs of an area over a fairly long period as to cause damage to standing crops and to reduce the yields. The irrigation commission of India defines drought as a situation occurring in any area where the annual rainfall is less than 75% of normal rainfall.

II. Classification

Drought can be classified based on duration, nature of users, time of occurrence and using some specific terms. Demarcation between the classifications is not well defined and many times, overlapping of the cause and effect of one on the rest is seen.

1. Based on duration

- (a) **Permanent drought** - This is characteristic of the desert climate where sparse vegetation growing is adapted to drought and agriculture is possible only by irrigation during entire crop season.
- (b) **Seasonal drought** - This is found in climates with well-defined rainy and dry seasons. Most of the arid and semiarid zones fall in this category. Duration of the crop varieties and planting dates should be such that the growing season should fall within rainy season.
- (c) **Contingent drought** - This involves an abnormal failure of rainfall. It may occur almost anywhere especially in most parts of humid or sub humid climates. It is usually brief, irregular and generally affects only a small area.
- (d) **Invisible drought** - This can occur even when there is frequent rain in an area. When rainfall is inadequate to meet the evapotranspiration losses, the result is borderline water deficiency in soil resulting in less than the optimum yield. This occurs usually in humid regions.

2. Based on nature of the users (NCA, 1976)

- (a) **Meteorological drought** - It is defined as a condition, where the annual precipitation is less than the normal over an area for prolonged period (month, season or year).
- (b) **Atmospheric drought** - It is due to low air humidity, frequently accompanied by hot dry winds. It may occur even under conditions of adequate available soil moisture. It refers to a condition when plants show wilting symptoms during the hot part of the day, when transpiration exceeds absorption temporarily for a short period. When decreases, absorption keeps pace with transpiration and plants revive (mid day wilt).
- (c) **Hydrological drought** - Meteorological drought, when prolonged results in hydrological drought with depletion of surface water and consequent drying of reservoirs, tanks etc. It results in deficiency of water for all sectors using water. This is based on water balance and how it affects irrigation as a whole for bringing crops to maturity.
- (d) **Agricultural drought** - It is the result of soil moisture stress due to imbalance between available soil moisture and evapotranspiration of a crop. It is usually gradual and progressive. Plants can therefore, adjust at least partly, to the increased soil moisture stress. This situation arises as a consequence of scanty precipitation or its uneven distribution both in space and time. It is also usually referred as soil drought.

Relevant definition of agricultural drought appears to be a period of dryness during the crop season, sufficiently prolonged to adversely affect the yield. The extent of yield loss depends on the crop growth stage and the degree of stress. It does not begin when the rain ceases, but actually commences only when the plant roots are not able to obtain the soil moisture rapidly enough to replace evapotranspiration losses. Important causes for agricultural drought are:

- Inadequate precipitation,
- Erratic distribution,
- Long dry spells in the monsoon,
- Late onset of monsoon,
- Early withdrawal of monsoon, and
- Lack of proper soil and crop management

3. Based on time of occurrence

- (a) **Early season drought** - It occurs due to delay in onset of monsoon or due to long dry spells after early sowing.

- (b) **Mid season drought** - It occurs due to long gaps between two successive rains and stored moisture becoming insufficient during this long dry spell.
- (c) **Late season drought** - It occurs due to early cessation of rainfall and crop water stress at maturity stage.

4. Other terms to describe drought

- (a) **Apparent drought** - What is drought for one crop may not be drought for another crop; what is drought in red soil may not be drought in black soil.
- (b) **Physiological drought** - It refers to a condition where crops are unable to absorb water from soil even when water is available, due to the high osmotic pressure of soil solution due to increased soil concentration, as in saline and alkaline soils. It is not due to deficit of water supply.

III. Periodicity of drought:

The Indian Meteorological Department (IMD) examined the incidence of drought for the period from 1871 to 1967, utilizing the monthly rainfall of 306 stations in the country. It was seen that during 1877, 1899, 1918 and 1972, more than 40 per cent of the total area experienced drought. General observation on the periodicity of drought in respect of different meteorological subdivisions of India is given Table 13.7.

Table 13.7. Periodicity of Drought in India

<i>Meteorological subdivisions</i>	<i>Period of recurrence of drought</i>
Assam	Very rare, once in 15 years
West Bengal, Madhya Pradesh, Konkan, Coastal Andhra Pradesh, Kerala, Bihar, Orissa	Once in 5 years
South interior Karnataka, Eastern Uttar Pradesh, Gujarat, Vidharbha, Rajasthan, Western Uttar Pradesh, Tamil Nadu, Kashmir, Rayalaseema and Telangana	Once in 3 years
Western Rajasthan	Once in 2.5 years

IV. Drought periods:

- (i) **Beginning of drought:** Droughts do not occur in Assam, South Kerala and eastern part of West Bengal. Severe drought begins on 1st October in the northwest arid zone and even much earlier in the western parts of the country. In the southern arid zone and adjoining interior portion of Maharashtra, the severe drought begins by the end of November. In most of the central portion of the country to the east of the line joining Delhi, Udaipur and Baroda, the commencement is only in the month of February or later. This is due to high water holding capacity of the black soil region. In the western coastal region of Maharashtra and Karnataka, the rainfall is very high. In spite of this, severe drought begins by December-January, probably because of the lower water holding capacity of the soil. Severe drought commences only after April in Gwalior, Guna, Jabalpur, Pendra, and Satna regions of Madhya Pradesh.
- (ii) **Closure of drought:** In general, severe drought ends outside the regions of east Bihar, Tamil Nadu, Karnataka, and southern Andhra Pradesh only by 1st May. In most of these regions, it ends after 15th May. In the arid zone of northwest India, severe drought ends normally during

the second fortnight of June, except in the Jaisalmer and Bikaner regions where normally cessation of severe drought is only by the first week of July.

V. Drought on crop production:

- **Water relations:** Drought alters the water status by its influence on absorption, translocation and transpiration. The lag in absorption behind transpiration results in loss of turgor as a result of increase in the atmospheric dryness.
- **Photosynthesis:** Photosynthesis is reduced by moisture stress due to reduction in photosynthetic rate, chlorophyll content, leaf area and increase in assimilates saturation in leaves (due to lack of translocation).
- **Respiration:** Respiration increases with mild drought but more severe drought lowers water content and respiration.
- **Anatomical changes:** Decrease in size of the cells and intercellular spaces, thicker cell wall and greater development of mechanical tissue are the anatomical changes. Stomata per unit leaf tend to increase.
- **Metabolic reaction:** Almost, all metabolic reactions are affected by water deficits.
- **Hormonal relationships altered:** The activity of growth promoting hormones like cytokinin, gibberlic acid and indole acetic acid decreases and growth regulating hormone like abscisic acid, ethylene etc. increases.
- **Nutrition:** The fixation, uptake and assimilation of N is affected. Since dry matter production is considerably reduced, the uptake of NPK is reduced.
- **Growth and Development:** Drought results in decrease in growth of leaves, stems and fruits. Maturity is delayed if drought occurs before flowering, while it advances if drought occurs after flowering.
- **Reproduction and grain growth:** Drought at flowering and grain development determines the number of fruits and individual grain weight, respectively. Panicle initiation in cereals is critical while drought at anthesis may lead to drying of pollen. Drought at grain development reduces yield while vegetative and grain-filling stages are less sensitive to moisture stress.
- **Yield:** The effect on yield depends on what proportion of the total dry matter is considered as useful material to be harvested. If it is aerial and underground parts, effect of drought is as sensitive as total growth. When the yield consists of seeds as in cereals, moisture stress at flowering is detrimental. When the yield is fibre or chemicals where economic product is a small fraction of total dry matter, moderate stress on growth does not have adverse effect on yields.

13.5 SOIL MOISTURE CONSTRAINTS

Inadequate soil moisture availability is the major constraint in dry farming. All the above factors directly and indirectly affect the soil moisture. Availability of soil moisture to crops is affected by rainfall behavior as well as by various soil properties.

- Shallow soils, degraded soils, eroded soils, gravelly soils and coarse textured soils have poor water holding capacity and hence can not store much of rainfall.
- Wind and water erosion remove the finer soil particles and expose the hard, impermeable subsoil causing less infiltration and less water storage.
- Crusting of soil surface after rainfall reduces infiltration and storage of rainfall, due to high run off.

- Compaction in surface and sub soil hardpans and poor soil structure affect infiltration and water storage.
- Poor organic matter content adversely affects soil physical properties related to moisture storage.

13.5.1 Methods of Soil Moisture Conservation

They are grouped as follows:

- I. By adapting proper tillage
- II. Control of run off water and soil erosion
- III. Recycling of rain water
- IV. Reducing loss of soil moisture by mulching and antitranspirants
- V. By increased rainfall use efficiency

I. Tillage

Tillage may be described as the practice of modifying the state of the soil in order to provide conditions favourable to crop growth. The objectives of tillage in dry lands are to:

- develop desired soil structure for a seedbed, which allows rapid infiltration and good retention of rainfall.
- minimize soil erosion by following practices as contour tillage, tillage across the slope etc.
- control weeds and remove unwanted crop plants.
- manage crop residues, through mixing of trash is desirable for achieving good tilth and decomposition of residues. However, the retention of trash on top layers is also useful in reducing erosion. On the other hand, complete coverage of residues sometimes necessitates control of insects or to prevent interference with precision planting operations.
- obtain specific soil configurations for *in situ* moisture conservation, drainage, planting etc.
- incorporate and mix manures, fertilizers, pesticides or soil amendments into the soil.
- accomplish segregation by moving soil from one layer to another, removal of rocks or root harvesting.

Hence, attention must be paid to the depth of tillage, time of tillage, direction of tillage and intensity of tillage.

(a) **Depth of tillage** - The depth of tillage depends on soil type, crop and time of tillage. **Deep tillage** of 25–30 cm is beneficial for deep heavy clay soils to improve permeability and to close cracks formed while drying. In soils with hard pans, deep tillage once in 2–3 years with chisel plough up to 35–45 cm depth at 60–120 cm interval will increase effective depth for rooting and moisture storage. Deep tillage is preferable for cotton, red gram and other deep-rooted crops. It is not recommended for shallow, gravelly, light textured soils.

Medium deep tillage of 15–20 cm depth is generally sufficient for most soils and crops. It is recommended for medium deep soils, shallow rooted crops, soils with pan free horizon and for stubble incorporation. **Shallow tillage** up to 10 cm is followed in light textured soils, and shallow soils and in soils highly susceptible to erosion. In soils prone for surface crusting, shallow surface stirring or shallow harrowing is useful.

(b) **Time of tillage** - Early completion of tillage is often helpful to enable sowing immediately after rainfall and before the soil dries up. Summer tillage or off-season tillage done with pre-season

rainfall causes more conservation of moisture and also enables early and timely sowing. It is particularly useful for pre-monsoon sowing.

- (c) **Direction of tillage** - For moisture conservation, ploughing across slope or along contour is very effective. Plough furrows check the velocity of runoff, promote more infiltration when water stagnates in the depressions caused by plough furrows and improves soil moisture storage.
- (d) **Intensity of tillage** - It refers to the number of times tillage is done. Frequent ploughing in shallow light textured soils will pulverize the soils into fine dust and increase the susceptibility to erosion. In heavy soils, leaving the land in a rough and cloddy stage prior to sowing is useful for more depression storage. The concept of minimal tillage is also practiced in dry lands. Here tillage is confined to seeding zone only and the inter-space is not tilled. It not only saves time, energy and cost but also helps moisture conservation. The practice of "set line cultivation" adopted in some dry regions is an example of minimum tillage. Here the seed row space is fixed and season after season, tillage is done only in this seeding strip. The intervening strip is not tilled.
- (e) **Modern concept of tillage** - In dry lands, rainfall is received simultaneously over a large area. In order to ensure timely sowing before soil dries up, the interval between land preparations and sowing must be narrowed down. This calls for completion of tillage over a large area in quick time. Dependence on bullock power and traditional wooden plough may not help in this regard. Use of more efficient tillage implements and mechanization of tillage operations are warranted. Tillage in dry lands also encompasses land shaping for *in situ* soil moisture conservation. Implements that can carryout tillage and land shaping in one single operation will help in saving time and cost. If land preparation, land shaping and sowing can be done in one single operation it can save considerable time. This is termed as once over tillage, plough planting or conservation tillage. Suitable tractor drawn machinery like a broad bed former cum seeder, basin lister cum seeder, which can complete the land shaping and sowing simultaneously, can be used:
1. minimum/optimum/reduced tillage.
 2. conservation/mulch tillage.
 3. zero tillage.
- (i) **Minimum/optimum/reduced tillage:** The objectives of these systems include (a) reducing energy input and labour requirement for crop production, (b) conserving soil moisture and reducing erosion, (c) providing optimum seedbed rather than homogenizing the entire soil surface, and (d) keeping field compaction to minimum.
- (ii) **Conservation/mulch tillage:** The objectives are to achieve soil and water conservation and energy conservation through reduced tillage operations. Both systems usually leave crop residue on the surface and each operation is planned to maintain continuous soil coverage by residue or growing plants. The conservation tillage practices may advance some of the goals of alternative farming such as increasing organic matter in soil and reducing soil erosion, but some conservation tillage practices may increase the need for pesticides. Conservation tillage changes soil properties in ways that affect plant growth, and reduce water runoff from fields. The mulched soil is cooler and soil surface under the residue is moist, as a result many conservation tillage systems have been successful.
- (iii) **Zero tillage or no-till system:** Here, the crop residue is usually shredded and planting is done without pre tillage. No till planting has problem of adequate weed control.

II. Soil erosion and runoff

Detachment and transport of soil and soil material caused by water and wind are widely prevalent in dry farming regions. Erosion takes place in both red soils and black soils. Soil and water are the most critical basic resources, which must be conserved as effectively as possible. No phenomenon is more destructive than soil erosion through which fertile topsoil and rainwater are lost. Soil and water conservation is the only known way to protect the lands from degradation and conserving rainwater for improving the productivity of dry land crops. Runoff leads to wastage of rainfall. Under unchecked conditions, even up to 40% of rainfall may be lost as runoff. Even when moisture conservation practices are adopted, about 10-20% of rainfall may be lost as runoff because of high intensity rainfall. Erosion removes topsoil and exposes hard impermeable sub soil, increasing the chances of more run off. Erosion adversely affects soil physical properties such as loss of structure, reduced infiltration, soil depth and soil moisture storage capacity. Loss of topsoil through erosion leads to loss of plant nutrients and poor soil fertility.

A. Soil erosion:

Soil erosion is the process of detachment of soil particles from the topsoil and transportation of the detached soil particles by wind and/or water. The detaching agents are falling raindrop, channel flow and wind. The transporting agents are flowing water, rain splash and wind. Out of 328 m.ha. of India's geographical area, 175 m.ha. (53.3%) subject to soil erosion and all kind of land degradation. Out of which 104.6 m.ha. are cultivable. Recent estimates indicate that about 5,333 mt. (16.35 t/ha) of soil is detached annually (29% carried away by rivers to the sea, 10% deposited in reservoirs resulting 1-2% loss of storage capacity).

Types of erosion

- (a) **Geological erosion:** It is said to be in equilibrium with the soil forming process. It takes place under natural vegetative cover completely undisturbed by biotic factors. This long time slow process has developed the present topographic features like stream channels, valleys, etc., through weather abnormalities such as intensive rainfall and biotic interference.
 - (b) **Accelerated erosion:** It is due to disturbance in natural equilibrium by the activities of man and animals through land mismanagement, destruction of forests, overgrazing, etc. Soil loss through erosion is more than the soil formed due to soil forming process.
 - (c) **Water erosion:** Water and wind are the main agencies responsible for soil erosion. Loss of soil from land surface by water, including runoff from melted snow and ice is usually referred to as water erosion. The major erosive agents in water erosion are impacting raindrops and runoff water flowing over the soil surface. Erosion and sedimentation embody the processes of detachment, transportation and deposition of soil particles. Detachment is dislodging of soil particles from soil mass by the erosive agents. Transportation is movement of detached soil particles (sediment) from their original location. The sediment moves along the stream and part of it may eventually reach the ocean. Some sediment is usually deposited at the base of the slopes, reservoirs and flood plains along the way.
- (i) **Forms of water erosion:** Sheet, Rill, gully, ravine, landslide and stream bank erosion.
 - (ii) **Factors affecting water erosion:**
 - Rainfall – amount, intensity, duration and distribution

- Soils – primary particle size, distribution, organic matter, structure, Fe and Al oxides, initial moisture content
- Topography – nature and length of slope
- Soil surface cover – plant canopy or mulches
- Biotic interference – disturbance of natural balance

(iii) **Losses due to erosion:** The losses due to erosion are loss of fertile top soil, loss of rain water, nutrient losses, silting up of reservoirs, damage to forests, reduced ground water potential, damage to reservoirs and irrigation channels and adverse effect on public health.

(iv) **Water erosion control:** Water erosion can be minimized by preventing the detachment of soil particles and their transportation. Principles of water erosion control are:

- Maintenance of soil infiltration capacity
- Soil protection from rainfall
- Control of surface runoff
- Safe disposal of surface runoff

Control measures are grouped in to agronomic, mechanical and forestry measures

Agronomic: Choice of crops, land preparation, contour cultivation, strip cropping, mulching, application of manures and fertilizers and appropriate cropping systems.

Mechanical: Contour bunding, graded bunding, bench terracing, contour trenching, gully control and vegetative barriers.

Forestry: Perennial trees and grasses.

(d) **Wind erosion** - Erosion of soil by the action of wind is known as wind erosion. It is a serious problem on lands devoid of vegetation. It is more common in arid and semiarid region. It is essentially a dry weather phenomenon stimulated by soil moisture deficiency. The process of wind erosion consists of three phases: initiation of movement, transportation and deposition. About 33 m.ha in India is affected by wind erosion. It includes 23.9 m.ha of desert and about 6.5 m.ha of coastal sands.

(i) **Forms of wind erosion:** Transportation of soil particles by wind takes place in three ways.

Saltation: Movement of soil particles by a short series of bounces along the ground surface.

Suspension: Movement of fine dust particles, smaller than 0.1mm dia floating in the air.

Surface creep: Rolling and sliding of soil particles along the ground surface due to impact of particles descending and hitting during saltation is called surface creep.

(ii) **Factors affecting wind erosion:** The factors are soil clodiness, surface roughness, water stable aggregates and surface crust (Mechanical stability), wind and soil moisture (surface is dry or slightly moist), field length, vegetative cover, organic matter (cementing), topography and soil type (sand erodes easily).

(iii) **Losses due to wind erosion:** Fertile topsoil is lost. Fertile soils are converted into unproductive sandy soils drifting sand. Yield losses due to abrasive action of wind driven soil particles, especially on broad leaved crops.

(iv) **Wind erosion control:** Greatest damage by wind erosion occurs during summer months in dry regions, where soil surface is bare and wind velocity is at its peak. Basic principles of wind erosion control are:

- Reducing wind velocity at ground surface, sufficient to prevent it being able to pickup soil particles.

- Increasing the size of soil aggregates or covering the soil with a non-erodable surface.
- Trapping the saltating soil particles.
- Keeping the soil moist so that soil particles moving by saltation lose their momentum at the surface.

Practices such as stubble mulching and minimum tillage, cover crops, strip-cropping, crop rotation, wind barriers and shelterbelts and mulches can be practiced to minimize wind erosion.

III. In situ moisture conservation techniques

Storage of rainfall in soil at the place where it falls is termed as “*in situ*” soil moisture conservation. It aims at increasing infiltration of rainfall into the soil and reducing runoff loss of rainwater. *In situ* soil moisture conservation can be accomplished through.

- Cultural/agronomic methods
- Mechanical methods
- Agrostological/biological methods

Extent of soil moisture storage from rainfall is influenced quantity and intensity of rainfall, slope, soil properties such as texture, structure, depth, surface characters, presence of subsoil hard pans, rate of infiltration and permeability, water holding capacity, vegetative cover, etc.

<i>Cultural/agronomical methods</i>	<i>Mechanical methods</i>	<i>Agrostological/biological methods</i>
Addition of organic matter, Summer ploughing, mulching cultivation, strip cropping	Basin listing, Bunding, Ridges and furrows, Tie ridging, Random tie ridging, Broad bed furrow, Dead furrow, Furrows after crop establishment	Pasture, Strip cropping with grasses, Ley farming, Vegetative barriers

1. Cultural /Agronomical methods

- (i) **Addition of organic matter:** By improving soil physical properties and water holding capacity.
- (ii) **Off season/summer tillage:** Plough furrows can hold water in the depressions and thereby increase the infiltration. When done across the slope, the plough furrows check runoff, reduce the velocity of runoff water and improve storage. Summer tillage is a traditional practice helps in the storage of pre-sowing rainfall. When ploughing is done along contour, it is termed as contour ploughing and is more helpful for *in situ* moisture conservation. Summer ploughing also helps in control of perennial weeds, pest control and enables early sowing with onset of rains.
- (iii) **Contour farming:** Ploughing along the contour and sowing reduce soil erosion and reduce runoff. For *e.g.*, Jowar sown in the black soils on contour line restricts the run off to 13.7% of the total rainfall and soil loss to 2.4 t/ha/year.
- (iv) **Cover crops:** Erosion will be reduced if the land surface is fully covered with foliage. *e.g.*, black gram, green gram, groundnut and fodder grasses like *Cenchrus ciliaris*, *Cenchrus glaucus*, dinanath grass, marvel grass. Both contour cropping and cover cropping can be practiced when the slope is less than 2 per cent.
- (v) **Mixed cropping**
- (vi) **Inter cropping**
- (vii) **Mulching**

- (viii) **Strip cropping:** Strip intercropping involves erosion resistant crops and erosion permitting crops in alternate strips of 2–3 m width across slope and along the contour. Erosion resistant crops include grasses and legumes with rapid canopy development. For example, *Cenchrus glaucus* + *Stylosanthes hamata*.

2. Mechanical methods

The basic principle are: (i) shaping the land surface manually or with implements in such a way as to reduce the velocity of runoff, (ii) to allow more time for rainfall to stand on soil surface, and (iii) to facilitate more infiltration of rainfall into soil layers.

Choice of any particular method under a given situation is influenced by rainfall characters, soil type, crops, sowing methods and slope of land.

- (i) **Basin listing:** Formation of small depressions (basins) of 10–15 cm depth and 10–15 cm width at regular intervals using an implement called basin lister. The small basins collect rainfall and improve its storage. It is usually done before sowing. It is suitable for all soil types and crops.
- (ii) **Bunding:** Formation of narrow based or broad based bunds across slope at suitable intervals depending on slope of field. The bunds check the free flow of runoff water, impound the rain-water in the inter-bund space, increase its infiltration and improve soil moisture storage. Leveling of inter-bund space is essential to ensure uniform spread of water and avoid water stagnation in patches. It can be classified into three types:
- (a) **Contour bunding:** Bunds of 1 m basal width, 0.5 m top width and 0.5 m height are formed along the contour. The distance between two contour bunds depends on slope. The inter-bund surface is leveled and used for cropping. It is suitable for deep red soils with slope less than 1%. It is not suitable for heavy black soils with low infiltration where bunds tend to develop cracks on drying. Contour bunds are permanent structures and require technical assistance and heavy investment.
- (b) **Graded/field bunding:** Bunds of 30–45 cm basal width, and 15–20 cm height are formed across slope at suitable intervals of 20–30 m depending on slope. The inter-bund area is leveled and cropped. It is suitable for medium deep-to-deep red soils with slopes up to 1%. It is not suitable for black soils due to susceptibility to cracking and breaching. Bunds can be maintained for 2–3 seasons with reshaping as and when required.
- (c) **Compartmental bunding:** Small bunds of 15 cm width and 15 cm height are formed in both directions (along and across slope) to divide the field into small basins or compartments of 40 sq. m. size (8 × 5 m). It is suitable for red soils and black soils with a slope of 0.5–1%. The bunds can be formed before sowing or immediately after sowing with local wooden plough. It is highly suitable for broadcast sown crops. CRIDA has recommended this method as the best *in situ* soil moisture conservation measure for Kovilpatti region of Tamil Nadu. Maize, sunflower, sorghum performs well in this type of bunding.
- (iii) **Ridges and furrows:** Furrows of 30–45 cm width and 15–20 cm height are formed across slope. The furrows guide runoff water safely when rainfall intensity is high and avoid water stagnation. They collect and store water when rainfall intensity is less. It is suitable for medium deep-to-deep black soils and deep red soils. It can be practiced in wide row spaced crops like cotton, maize, chillies, tomato etc. It is not suitable for shallow red soils, shallow black soils and sandy/gravelly soils. It is not suitable for broadcast sown crops and for crops sown at closer row spacing less than 30 cm. Since furrows are formed usually before sowing, sowing by dibbling

or planting alone is possible. Tie ridging is a modification of the above system of ridges and furrows where in the ridges are connected or tied by a small bund at 2–3 m interval along the furrows. Random tie ridging is another modification where discontinuous furrows of 20–25 cm width, 45–60 cm length and 15 cm depth are formed between clumps or hills of crops at the time of weeding. Yet another modification of ridges and furrows method is the practice of sowing in lines on flat beds and formation of furrows between crop rows at 25–30 DAS. This enables sowing behind plough or through seed drill.

- (iv) **Broad Bed Furrow (BBF):** Here beds of 1.5 m width, 15 cm height and convenient length are formed, separated by furrows of 30 cm width and 15 cm depth. Crops are sown on the beds at required intervals. It is suitable for heavy black soils and deep red soils. The furrows have a gradient of 0.6%. Broad bed furrow has many advantages over other methods.
- It can accommodate a wide range of crop geometry *i.e.*, close as well as wide row spacing.
 - It is suitable for both sole cropping and intercropping systems.
 - Furrows serve to safely guide runoff water in the early part of rainy season and store rainwater in the later stages.
 - Sowing can be done with seed drills.
 - It can be formed by bullock drawn or tractor drawn implements. Bed former cum seed drill enables BBF formation and sowing simultaneously, thus reducing the delay between rainfall receipts and sowing.
- (v) **Dead furrow-** At the time of sowing or immediately after sowing, deep furrows of 20 cm depth are formed at intervals of 6–8 rows of crops. No crop is raised in the furrow. Sowing and furrowing are done across slope. It can be done with wooden plough in both black and red soils.

3. Agrostological methods

The use of grasses to control soil erosion, reduce run off and improve soil moisture storage constitutes the agrostological method. Grasses with their close canopy cover over soil surface and profuse root system, which binds soil particles, provide excellent protection against runoff and erosion. The following are the various agrostological methods of *in situ* moisture conservation.

- (i) **Pastures/grass lands:** Raising perennial grasses to establish pastures or grass lands is recommended for shallow gravelly, eroded, degraded soils. Grass canopy intercepts rainfall, reduces splash erosion, checks runoff and improves soil moisture storage from rainfall.
- (ii) **Strip cropping with grasses:** Alternate strips of grasses and annual field crops arranged across slope check runoff and erosion and help in increasing moisture storage in soil.
- (iii) **Ley farming:** It is the practice of growing fodder grasses and legumes and annual crops in rotation. Grasses and legumes like *Cenchrus*, *stylo* are grown for 3–5 years and followed by annual crops like sorghum for 2 year. When the field is under grasses or legumes, soil moisture conservation is improved.
- (iv) **Vegetative barriers:** Vegetative barrier consists of one or two rows of perennial grasses established at suitable interval across the slope and along the contour. It serves as a block to free runoff and soil transport. *Vetiver*, *Cenchrus* etc., are suitable grasses. *Vetiver* can be planted in rows at intervals of 40 m in 0.5% slope. Plough furrows are opened with disc plough first before commencement of monsoon. 5–8 cm deep holes are formed at 20 cm interval and two slips per hole are planted in the beginning of rainy season. The soil around the roots is compacted. *Vetiver* barriers check runoff and prevent soil erosion. While they retain the soil, they allow excess

runoff to flow through their canopy without soil loss. It is adapted to drought and requires less care for maintenance. It does not exhibit any border effect on crops in adjacent rows. It allows uniform spread of water to lower area in the field resulting in uniform plant stand thus increasing yield of a crop by 10–15%. It facilitates better storage of soil moisture. If fodder grasses like *Cenchrus glaucus* or marvel grass are used, fodder can also be harvested and given to the animal. Vegetative barriers are best suited for black soil. Unlike contour bunding, which gives way due to development of crack in summer in black soils, vegetative barriers do not allow such phenomenon in black soil. Hence, the vegetative barriers can be effectively maintained in black soil for 4–5 years. After 4–5 years, replanting material can also be had from the old barrier by ‘quartering’

IV. Recycling of rainwater

Runoff is that portion of precipitation, which makes its way towards stream, channel, lake or ocean as surface flow. Mostly runoff refers to surface flow only. Runoff from rainfall is inevitable and cannot be completely arrested. In dry farming areas, rainfall often occurs at high intensity, which exceeds the infiltration rate and causes runoff. Also, when quantity of rainfall exceeds the water holding capacity of soils, runoff has to take place. In certain instances, surface characteristics of soils also cause runoff. Usually, under unchecked conditions, about 40% of rainfall may be lost as runoff. Even if moisture conservation practices are adopted, about 10–15% of rainfall in black soils and about 20% of rainfall in red soils is lost as runoff.

The amount of such runoff varies with rainfall intensity, soil physical properties, soil surface characters, slope, vegetation cover and cultural practices. Runoff water, if not checked, flows out and is wasted, causing soil erosion. It can be guided, collected and recycled to augment water availability to rainfed crops. The collection, storage and recycling of runoff water constitute the process of water harvesting. Water harvesting can be viewed from two situations. First is a case of normal rainfall with high intensity on a few rainy days causing runoff. This runoff can be guided and collected in storage structures called farm ponds and reused for supplemental irrigation to crops suffering from moisture stress. This is termed as macro watershed approach or macro catchment water harvesting. In the second instance, total rainfall is less and soil storage is inadequate for supporting crop growth. Here part of the land is left barren and uncultivated. This is known as donor area and is treated in such a way as to increase runoff from rainfall. The runoff from the donor strip is directed towards the lower adjacent strip to increase soil moisture storage there. This strip is used for raising crops. This is called as micro watershed approach or micro catchment water harvesting.

(i) **Water harvesting through farm ponds:** The collection of rainwater and storing in big farm ponds is not a new concept in India. It is in vogue since early days in the form of tanks. Farm ponds are small storage structures constructed at the lowest point of a farm to collect and store runoff water. Runoff from various parts of the catchment area is properly guided through grassed waterways into the farm pond. The following points need to be considered while constructing farm ponds.

- Deep heavy soils with low permeability are better suited for farm pond technology than shallow light soils with high permeability. But, ironically, the usefulness of farm pond is more felt in light soils with low water storage capacity.
- Farm pond has to be constructed at the lowest point of the farm to collect runoff water from the entire farm area.
- Size of farm pond depends on rainfall quantity, soil type, area of catchment (farm size) and estimated runoff.

- Provisions for arresting soil inflow into the pond at the inlet point and a weir, for draining excess water when pond is full have to be made.
- Runoff has to be guided to the farm pond through grassed waterways.
- Water loss through seepage and, evaporation has to be checked. Seepage loss, can be reduced by lining the sides and bottom with soil + sand + cement or soil + cow dung + straw, spraying sodium chloride or sodium carbonate on the surface. Evaporation loss can be reduced by floating materials to prevent direct exposure of water surface, changing the shape of the pond to provide more depth rather than surface area (circular instead of rectangular).

Advantages - Harvested water can be used for protective irrigation to crops at critical stages. Since runoff is properly guided through grassed waterways, erosion is checked. Earth excavated from ponds can be used for bunding and leveling of fields. Stored water can be used as drinking water for humans and animals, for spraying operations and for fish rearing. High value tree crops can be raised near farm ponds with protective irrigation. A chain of farm ponds can recharge ground water in the region.

(ii) **Water harvesting under deficit rainfall:** The situation here is that the seasonal rainfall quantity by itself is not sufficient to support a crop till maturity. Therefore, runoff of rainfall from a part of the land left uncultivated is directed to an adjacent strip, which alone is used for cropping. In this strip (run-on strip/recipient area), the rainfall falling on its surface is supplemented by runoff directed from the other strip of land (donor area/runoff strip) and total water supply available is increased to facilitate cropping. This can be accomplished by the following practices. A portion of the field in the upper reach is left uncultivated. It is shaped or treated to increase runoff. This can be accomplished by covering the surface with polythene films or by water proofing it by spraying sodium carbonate or water repellent materials like silicone/asphalt or by shaping the land into a sloping, clear, smooth, compact surface to increase runoff. Runoff from this donor strip is guided to a smaller, strip on the lower reach to increase soil storage and to raise crops. The proportion of 'donor area' to cropped area depends on rainfall quantity, duration of rainfall, soil properties and crop characters. In the cropped area, land is shaped to conserve moisture. Acceptability of this method is however limited in regions where pressure on land does not permit leaving a large area barren for runoff harvesting.

Creating micro relief in cultivated field between seed rows to direct rainwater to crop root zone is another approach. Here, small alternate strips of land of suitable width are left without cropping. These un-cropped strips are ridged up and compacted or shaped to slope towards seed rows to increase runoff, which will flow towards cropped strip. The relative width of runoff strip and cropped strip varies from 2:1 to 4:1 depending on rainfall. Land shaping through raised ridges between crop rows, planting in shallow ditch or trench, formation of sloping beds towards tree trunk, saucer shaped basins around trees, semicircular or crescent shaped basins on the downward slope around trees etc., come under this category. The micro watershed methods are also termed as inter-row water harvesting or inter-plot water harvesting.

V. Reduction of loss of stored soil moisture

Rainfall infiltrates into the soil and permits downward and laterally and gets stored in soil profile. Part of it percolates down to ground water. Stored water is absorbed by plants and weeds. It is lost from the soil surface as evaporation and from crop and weed canopy as transpiration. The loss through evaporation from soil and transpiration by weeds can be checked to reduce loss of stored moisture. Excessive transpiration loss from crop plants can also be minimized. ET loss is by latent heat of vapourisation and is governed by energy, vapour pressure gradient and conductivity of medium. Evapotranspiration can be checked by:

- Minimizing the evaporative surface area
- Minimizing the energy need to the evaporative site
- Minimizing the diffusivity/conductivity of water movement from soil
- Minimizing the driving force or potential that is responsible for upward movement of water.

A. Reduction of evaporation loss

Evaporation happens to maintain soil thermal regime and is governed by soil moisture content, vegetative cover on surface, soil type, temperature gradient between soil and atmosphere and atmospheric water demand. Higher soil moisture content, especially a wet surface soil increases evaporation rate. As the surface soil dries up, continuity of capillary pores is disrupted and moisture movement upwards from deeper layers is reduced. Soil surface that is exposed to radiation without any vegetative cover offers more scope for evaporation due to over heating. Evaporation loss in a cropped field is more in the early growth stage when canopy cover is less, especially in widely spaced crops and slow growing species. Vegetative cover prevents direct exposure of soil surface to radiation, reduces heating of soil layers and thus checks the necessity for evaporation. Black soils tend to absorb more heat and may evaporate more water. When cracks are formed during drying, evaporation takes place from the sides of the cracks also. With high temperature, low humidity and dry winds, atmospheric water demand increases the rate of evaporation.

(a) Measures to reduce evaporation loss

- Shallow surface tillage:** When surface soil is stirred by tillage, the continuity of capillary pores is broken and the rise of water through capillary movement is obstructed. Shallow tillage after summer showers is beneficial in this regard. This process is called dust mulching. Inter tillage between crop rows during early dry spells has a similar effect.
- Mulching:** Mulching means covering the soil surface with any material such as organic wastes, plastic, polythene sheets etc. The organic wastes used for mulching include crop stubbles, straw, coir pith, groundnut shell, husk etc. These wastes at 5–10 t ha⁻¹ are spread on the soil surface to a thickness of 5-10 cm. Mulching provides the following benefits:
 - reduces direct impact of rain drops on soil particles and controls splash erosion.
 - increases infiltration.
 - reduces velocity of runoff water.
 - controls erosion.
 - improves soil moisture storage from rainfall.
 - controls evaporation loss.
 - suppresses weed growth.
 - influences thermal regime of soil by reducing soil temperature.
 - improves microbial activity.
 - controls salinity development.
 - can be incorporated as manures later.

Vertical mulching is a technique where in trenches of 40 cm wide, 15 cm deep are dug at 2–4 m interval across slope and filled with stubbles or organic wastes to a height of 10 cm above soil surface. Runoff is checked, collected in the shallow trenches and redistributed to adjoining soil layers. This method can be considered as precursor method to broad bed furrow method.

Live mulching is the term used to describe the covering soil surface through the plant canopy in intercropping system. *e.g.*, sorghum + forage cowpea, sorghum + sword bean.

Dust mulching refers to the soil condition associated with tillage. When land is ploughed or stirred, the surface soil is disturbed and this breaks the continuity of capillary pores from subsoil to surface. As a result, evaporation is checked and soil moisture is conserved. Guntaka (Blade harrow)/Danti/hand hoe are the implements used for dust mulching.

Stover mulch or straw mulch refers to covering the soil surface with cumbu/sorghum straw, sugarcane trash reduces the evaporation and increases soil moisture efficiency. Similarly mulching with organic waste, crop residues, plastic material can be done.

Stubble mulch is referred to the stirring of the soil with implements that leave considerable part of the vegetative material or crop residues or vegetative litter on the surface as a protection against erosion and for conserving moisture by favouring infiltration and reducing evaporation. Stubble mulch is very effectively done in western countries, where crop residue or by products like straw, stover or haulms are not given to animals as fodder. Special farm implements are available to create minimum disturbance and leave large surface area undisturbed. It also acts as minimum tillage and conservation tillage.

Pebble mulch where small pebbles like stone are placed on the soil surface. This mulching will be successful in dry land horticulture (fruit tree culture). The pebbles placed on the basins of trees not only reduce evaporation but also facilitate infiltration of rainwater into the basin.

Use of anti-evaporating chemicals: Chemicals like hexadecanol are used as anti-evaporants. When sprayed and mixed with soil surface, hexadecanol is reported to reduce evaporation by 43%. The treated surface layer dries up fast and creates a diffusional barrier for upward movement of water vapour. It is resistant to microbial activity and degradation. It remains in soil for more than a year. It also increased the soil aggregate stability. Evaporation from free water surface, farm ponds, lakes etc., can be reduced to 80% by wax emulsions, rubber/plastic boats or saw dust.

Shelter belt: In arid and semiarid regions, the hot winds dry the surface soil and create vapour pressure gradient and continuous vapourisation takes place. This continuous vapourisation can be arrested by raising shelterbelt. It is a practice of growing one or multi rows of trees/shrubs or crop plants across the wind direction either in the field or field boundaries to reduce the wind effect and to reduce the wind velocity. Shelterbelt reduces the evaporation and increases soil moisture content by 3–5% and this will be useful to alleviate the terminal moisture stress in crops grown in adjoining area. The increase in soil moisture percentage is due to favourable microclimate created by shelterbelts. It can be used as resting place of livestock in dry lands. Due to reduction in wind velocity, the pollen drift in orchard crops is minimized, there by pollination percentage is increased and fruit setting is improved. Many trees in shelterbelt are economically important. After long period of maintenance, the trees can be disposed off as timber and raw material for industrial use. Fruit trees grown in shelterbelt give fruits, which fetch higher economic returns. Windbreak is also a form of shelter belt, but only one row of tall trees having good leaf canopy are grown in North-South direction in order to reduce wind velocity and there by reduce soil erosion. Tall trees like eucalyptus, casuarinas, and wood apple are grown as wind breaks. After years of maintenance, these trees can be disposed of economically.

(iii) Measures to reduce transpiration loss: Though transpiration is necessary and unavoidable evil, excessive transpiration has to be controlled especially when soil moisture stress develops during critical stages of crop growth. The rate of transpiration is governed by soil moisture potential, atmospheric water demand and plant canopy characters such as leaf area, leaf orientation, stomatal resistance, etc. Transpiration loss can be reduced by the use of antitranspirants and by some cultural methods also.

A. Antitranspirants

Antitranspirants are substances or chemicals applied on plant-foilage to control rate of transpiration. The important points to be considered in using antitranspirants are:

- (a) They should restrict water loss from leaf surface without restricting entry of carbon dioxide for photosynthesis, and
- (b) Transpiration necessary for cooling of leaf surface should not be completely stopped by the application of antitranspirants leading to rise in leaf temperature.

Based on their mechanism of action, antitranspirants are classified into various types.

Stomatal closing type: They cause partial or complete closure of stomata by inducing the guard cells to close. But complete closure of stomata adversely affects gas exchange and photosynthesis. These chemicals may also cause phyto-toxicity and are very expensive too. *E.g.*, Phenyl mercuric acetate (PMA) and alkanyl succinic acid (ASA).

Film forming type: They cover the stomata by forming a thin film over leaf surface. These substances are nontoxic, non-degradable and very easy to apply but they adversely affect photosynthesis. *E.g.*, Paraffin and wax emulsions, folic 2%, and power oil 1%.

Reflectant type: When sprayed on leaf surface, the reflectant type antitranspirants increase the leaf albedo or leaf reflectance of sunlight. As a result, heating is reduced, leaf temperature inside is low and need for transpiration is reduced. *E.g.*, Kaolin and lime solution. Spraying kaolin at 3–6% concentration reduced leaf temperature by 3–4 °C and transpiration by 22–28%. These are less expensive, non phytoxic and do not interfere with photosynthesis, since stomatal closure does not take place.

Growth retardant type: Chemicals like cycocel (ccc-chloro choline chloride, chlor mequat) when sprayed on foliage, reduce leaf area and thereby reduce the transpiring area and transpiration.

B. Cultural methods

- (a) **Weed control:** Most weeds have a high transpiration coefficient *i.e.*, amount of water transpired to produce unit quantity of dry matter. Early weed control prevents unwanted transpiration loss through weeds.
- (b) **Shelterbelts:** Rows of trees grown across the direction of wind reduce air movement, reduce temperature of air and plant canopy, increase humidity in the protected strips and thereby reduce the atmospheric water demand and control transpiration in the inter space between shelterbelts.
- (c) **Alley cropping:** This practice refers to raising perennial shrubs or tall crops as hedge rows up to 1-2 m height at 48 m intervals and raising short stature annual crops in the alleys (inter space between hedge rows). A similar effect on reduction in atmospheric water demand and transpiration as described under shelterbelts is caused in alley cropping. This method is also called as hedgerow intercropping. *e.g.*,

Hedge row	Intercrop
Leucaena/Desmanthus	Black gram/cowpea/sunflower/groundnut
Agathi/castor/Perennial red gram/Casuarina (trained as bush)/ glyricidia/cowpea	Cotton/black gram

VI. Rainfall use efficiency (RUE)

The rainfall use efficiency is defined in many ways. The most common definition is WUE.

$$\text{WUE} = \text{Dry weight produced}/\text{ET}$$

WUE as the ratio of water used (ET) to the water potentially available (Rainfall + stored moisture).

Any soil moisture conservation technique, which increases the RUE, will be considered as the best management technique for that area. RUE is the relationship between yield and rainfall.

$$RUE = \text{Yield/Rainfall Kg/mm}$$

A. Choice of crops

Traditional cropping pattern in the dry farming areas is dominated by food grains viz., millets and pulses. In a predominantly subsistence type of farming system, such dominance of food crops is natural. The choice of crops for dry lands is affected by rainfall quantity and distribution, time of onset of monsoon, duration of monsoon, soil characters including amount of rainwater stored in the soil and farmer’s requirements. The criteria for choice of crops comprise the following

- tolerance to drought
- fast growth during initial period to withstand harsh environment
- genetic potential for high yield
- short or medium duration to escape terminal drought
- adaptability to wide climatic variations
- response to fertilizers

B. Selection of suitable varieties

In dry farming regions, traditional local crop varieties still dominate. The preference for these local varieties is based on their pronounced drought tolerance. But they are usually longer in duration susceptible to moisture stress at maturity. They have low yield potential even under favourable rainfall. They do not respond significantly to improved management such as nutrient supply. The criteria now adopted for selection of crop varieties for dry lands include drought tolerance, short or medium duration, high yield potential, response to nutrient supply, high water use efficiency, moderate resistance to pest and diseases.

C. Choice of cropping system

Cropping system refers to the spatial and temporal association of crops in a farming system. Choice of suitable cropping system must aim at maximum and sustainable use of resources especially water and soil. Cropping systems depend on rainfall quantity, length of rainy reason and soil storage capacity. The broad guidelines in choosing a cropping system for dry lands based on rainfall and soil characters are given in Table 13.8.

Table 13.8. Broad Guidelines in choosing Cropping System

<i>Rainfall (mm)</i>	<i>Soil type</i>	<i>Growing Season (weeks)</i>	<i>Profile storage capacity (mm)</i>	<i>Suggested cropping system</i>
350-600	Alfisols, shallow vertisols	20	100	Single rainy season cropping sorghum/maize/soybean
350-600	Deep arid sols, Entisols (alluvium)	20	100	Single cropping sorghum/maize/soybean in kharif/rabi
350-600	Deep vertisols	20	100	Single post rainy season cropping sorghum

(Contd.)

<i>Rainfall (mm)</i>	<i>Soil type</i>	<i>Growing season (weeks)</i>	<i>Profile storage capacity (mm)</i>	<i>Suggested cropping system</i>
600-750	Alfisols, vertisols, entisols	20-30	150	Intercropping 1. Sorghum + Pigeon pea 2. Cotton + Black gram
750-900	Entisols, deep vertisols, deep alfisols, inceptisols	30	200	Double cropping with monitoring 1. Maize-Safflower 2. Soybean-Chick peag 3. Groundnut-Horse gram
> 900	As above	> 30	> 200	Assured double cropping Maize-Chick pea, Soybean - Safflower

D. Intercropping

Intercropping refers to growing two or more crops in the same field during the same season. Intercropping is widely practiced in dry farming since it offers many advantages. Intercropping is a risk minimization strategy and provides an insurance against complete crop failure due to rainfall abnormalities. This is made possible through the duration difference between component crops. It provides more yield and income per unit area per unit time than sole cropping. Stability in production is achieved. Multiple products for home consumption as well as for marketing are made available. When legumes are included in intercropping, soil fertility is enriched. Intercrop canopy suppresses weed growth. Some intercrop combinations provide biological control of pests and diseases (*e.g.*,) cotton + cluster bean cropping system. Intercrop cluster bean reduces jassid incidence in cotton. Resource use efficiency is increased *viz.*, light, water and nutrients are efficiently used. However, for success in intercropping, the competition between component crops must be minimized and the complimentary effects must be maximized. This can be accomplished by the following means;

- Choice of suitable component crops differing in duration, rooting pattern, canopy architecture, nutrient requirement and occurrence of critical stages
- Selection of genotypes in each component crop
- Optimum population of component crops
- Suitable crop geometry to provide adequate space for intercrops
- Preference for leguminous crops as intercrops

The important intercropping systems suitable for dry lands are given in Table 13.9.

Table 13.9. Important Intercropping Systems suitable for Dry Lands

<i>Crops</i>	<i>Geometry</i>	<i>Base crop duration</i>	<i>Intercrop duration</i>
Sorghum + Lablab	6-8:2	100-120	150-180
Sorghum + Red gram	6-8:1	100-120	180
Sorghum + Cowpea	2:1	100-120	80

(Contd.)

<i>Crops</i>	<i>Geometry</i>	<i>Base crop duration</i>	<i>Intercrop duration</i>
Cotton + Black gram	2:1	150-185	65-75
Groundnut + Red gram	6-8:1	105	180
Groundnut + Castor	6-8:1	105	150-180
Bengal gram + Coriander	4:1	100	80
Maize + Cowpea	2:1	100-110	75-80
Ragi + Cowpea + Red gram	6:1:1	100	75 + 180

E. Double cropping in dry lands

Double cropping either by sequential cropping or relay cropping is possible in places with high rainfall (> 900 mm) extended rainy season and high soil moisture storage capacity.

(a) Double cropping by relay cropping

Groundnut/Ragi (June–Sep)	+	Red gram (June–January)	-	Horse gram (September–January)
------------------------------	---	----------------------------	---	-----------------------------------

Groundnut or ragi is sown with red gram as intercrop in 6:1 proportion in June. After harvest of groundnut in September, horse gram is relay sown in the space between red gram rows.

(b) Double cropping by sequential cropping

Pearl/ragi/samai (May–September)	Horse gram (September–January)
Groundnut/sesamum (May–September)	Horse gram (September–January)
Cowpea/green gram (June–September)	Sorghum (October–January)
Sorghum (July–October)	Chickpea (October–February)

(c) Efficient double cropping system for dry lands of India

<i>Soil type</i>	<i>Region</i>	<i>Water availability (days)</i>	<i>Double cropping system</i>
Vertisols	Madhya Pradesh	210-230	Maize–chickpea Soybean–wheat
	Maharashtra	190-210	Sorghum–safflower
	Karnataka	130-150	Cowpea–sorghum Green gram–safflower
Inceptisols	Uttar Pradesh	200-230	Rice–Chickpea
		180-200	Pearl millet–chickpea Black gram–mustard
Oxisols	Bihar	160-180	Maize–chickpea
Alfisols	Karnataka	Groundnut–barley	
		190-220	Cowpea–ragi Soybean–ragi
Alfisols and aridisols		< 120	No double cropping

(d) Crop substitution

It refers to the replacement of an existing low yielding crop with another crop, which is better adapted to the prevailing environment and is capable of giving higher yield under similar climatic conditions. For many dry farming regions of India, more suitable crops than existing ones have been identified. However, the acceptance and adoption of the practice of crop substitution by dry land farmers is poor, since in most instances, the new crops replace food crops. In vertisols of Tamil Nadu, sunflower and maize are substituting millets and senna substituting low value pulses.

13.6 CLIMATOLOGICAL APPROACH FOR CROP PLANNING

Crops and varieties selected should match the length of growing season during which they are not subjected to soil moisture stress. Climatological analysis helps to identify cultivars suitable for different regions. Feasibility for intercropping, sequence cropping and double cropping can also be known from such analysis. For regions with cropping season less than 20 weeks, single crop during *kharif* or *rabi* is recommended. Regions with more than 30 weeks and above have no problem for double cropping. In regions with 20–30 weeks cropping season, double cropping may be risky. Such areas are ideal for intercropping.

Table 13.10. Length of effective Cropping Season in different Areas of India

Category	Effective cropping season (weeks) in different areas			Potential cropping system
< 20 weeks	Bellary (8)	Jodhpur(11)	Anantapur (13)	Sole cropping
20-30 weeks	Hissar (17)	Rajkot (17)	Bijapur (17)	Intercropping
	Jhansi (21)	Kovilpatti (21)	Hyderabad (22)	
	Udaipur (22)	Solapur (23)	Agra (24)	
	Anand (25)	Akola (27)		
> 30 weeks	Bhubaneswar (32)	Varanasi (32)	Indore (36)	Sequence cropping
	Bangalore (36)	Hoshiarpur (35)	Dehradun (44)	
	Rewa (36)	Ranchi (45)		
	Samba (44)			

(Randhawa and Venkateswarulu, 1979)

Water balance for different agroclimatic regions has been calculated and water availability periods worked out. Regions with 350–600 mm rainfall having 20 weeks effective growing season are suitable for single cropping in *kharif* (red and shallow black soils) or *rabi* (deep black soils). Intercropping is possible in regions receiving 600–750 mm rainfall and having 20–30 weeks of effective growing season. Areas with more than 750 mm rainfall or with more than 30 weeks are suitable for double cropping.

Optimum population: Poor or suboptimal population is a major reason for low yields in rainfed crops. Establishment of an optimum population depends on seed treatment, sowing at optimum soil moisture, time of sowing, depth of sowing, method of sowing and crop geometry.

(a) **Seed treatment:** Seed treatment is done for many purposes such as protection against pests and diseases, inoculation of bio-fertilizers and inducing drought tolerance. Seed treatment with insecticides and fungicides is a low cost technology for protection against pests and diseases. In dry lands, spraying of chemicals for pest control is difficult due to scarcity of water. Hence, a preventive measure through

seed treatment is very useful. Bio-fertilizers like azospirillum, rhizobium and phosphobacterium are applied through seed inoculation as a low cost technology for nutrient supply.

Table 13.11. Suitable Cropping Systems based on Rainfall and Water Availability Period

Rainfall (mm)	Soils	Water Availability period (weeks)	Potential cropping system
350-600	Alfisols and Shallow vertisols	20	Single kharif cropping
350-600	Aridisols and Entisols	20	Single cropping either in kharif or rabi
350-600	Deep Vertisols	20	Single rabi cropping
600-750	Alfisols, Vertisols and Entisols	20-30	Intercropping
750-900	Entisols, Deep Vertisols, Alfisols and Inceptisols	>30	Double cropping with monitoring
>900	Entisols, Deep vertisols, Alfisols and Inceptisols	>30	Assured double cropping

(i) **Seed hardening:** It is done to induce drought tolerance in emerging seedlings. It is the process of soaking seeds in chemical solution and drying to induce tolerance to drought. Soil moisture stress immediately after sowing affects germination and establishment. Seed hardening enables seedlings to survive this early moisture stress. During seed hardening, seeds are subjected to partial hydration followed by dehydration before sowing. Seeds are soaked for specified time in chemical solutions of prescribed concentration. Soaked seeds are then dried in shade back to original moisture content. During soaking, seeds imbibe water and germination process is started but not completed. The hardened seeds are thus in a ready state for germination. When sown in moist soils, seeds germinate immediately. Such early germination helps in seedling emergence before surface soil dries up.

The seed hardening ensures early germination by 2–3 days compared to untreated seeds and induces better root development, which enables absorption of more moisture. Germination and seedling emergence are completed before surface soil dries out. It induces drought tolerance by increasing the resistance to protoplasmic dehydration in young seedlings subjected to moisture stress. Hardened seeds can be sown immediately or within 30 days of treatment. The seed hardening is considered as low cost technology and is the most important requirement for pre-monsoon sowing. For success in seed hardening, attention must be paid in selection of right chemical, its concentration, time of soaking, volume of solution and drying under shade to original moisture content. The seed hardening for various crops is given in Table 13.12.

For pulses (black gram/green gram), 4 kg of wood ash is collected, powdered thoroughly to which 30% *Acacia gum* is added and mixed thoroughly so that wood ash-gum paste is obtained. 8 kg of black gram or green gram seed is spread over the *Acacia*-wood ash paste and mixed thoroughly so that all the seeds are smeared with the paste. The treated seeds are shade dried for 5 hours and then can be sown.

(b) **Sowing at optimum soil moisture:** An effective rainfall of 20–25 mm, which can wet a depth of 10–15 cm, is needed for sowing. Moisture stress at or immediately after sowing adversely affects germination and establishment of seedlings. To ensure adequate soil moisture at sowing, sowing has to be done as early as possible after soaking rainfall is received. Sowing methods and implements play a crucial role in this regard.

(c) **Time of sowing:** Optimum time of sowing is indicated by adequate rainfall to wet seeding depth and continuity of rainfall after sowing. The probable sowing time in a rainfed area is the week which has

a rainfall of not less than 20 mm with coefficient of variability less than 100% and the probability of a wet week following wet week. Timely sowing ensures optimal yield besides it may also help pest avoidance.

Table 13.12. Seed Hardening for various Crops

<i>Crop</i>	<i>Chemical</i>	<i>Concentration</i>	<i>Soaking time</i>	<i>Volume of solution per kg seed</i>
Rice	Potassium chloride	1 %	Water-10 hrs chemical-10 hrs	1 litre
Sorghum	Potassium di-hydrogen phosphate	2 %	6 hrs	350 ml
	Potassium chloride	1 %	5 hrs	1 litre
Pearl millet	Potassium chloride	2 %	16 hrs	1 litre
	Sodium chloride	3%		
Ragi	Calcium chloride	0.5%	Until visibility of embryo growth	1 litre
Sunflower	Zinc sulphate	2 %	12 hrs	1 litre
Cotton	CCC	1000 ppm	6 hrs	1 litre
	KCl	2%	5 hrs	1.6 litre
	DAP	2%	5 hrs	1.6 litre

Pre-monsoon dry seeding: In some regions, where heavy clay soils dominate, sowing after rains is impossible due to high stickiness of soil. Here, sowing is done in dry soil, 2–3 weeks before the onset of monsoon (pre-monsoon). Seeds will remain in soil and germinate only on receipt of optimum rainfall. The advantages of pre-monsoon dry seeding are early sowing, uniform germination and good establishment, utilization of first rainfall itself for germination instead of for land preparation in post monsoon sowing and early maturity before closure of monsoon and avoidance of stress at maturity. For sorghum in black soils, pre-monsoon dry seeding is recommended 1–2 weeks before onset of monsoon with depth of sowing at 5 cm and seed hardening with 2% potassium di-hydrogen phosphate or potassium chloride. For cotton in black soils, pre-monsoon dry seeding is recommended at 2–4 weeks before commencement of monsoon, with a sowing depth of 5 cm and seed hardening with CCC (500 ppm) or potassium chloride or DAP at 2% level.

The success of pre-monsoon dry seeding depends on the following:

- It is recommended for bold seeds like cotton and sorghum only and not for all crops.
- Time of advance sowing must be fixed based on rainfall analysis for date of onset of monsoon and continuity of rainfall after sowing.
- Seeds must be hardened to ensure quick germination and drought tolerance.
- Seeding depth must be such that seeds will germinate only after receipt of rainfall to wet that depth is received. Surface sowing may lead to germination with less rainfall and death due to subsequent soil drying.
- Off season tillage is necessary to enable sowing in dry soil before monsoon.
- Seed damage by soil insects has to be prevented.

(d) **Optimum depth of sowing:** When seeds are sown on surface or at very shallow depth, germination and seedling growth are affected when surface soil moisture dries up. Sowing at a depth where soil moisture availability is adequate, ensure early and uniform germination and seedling establishment. Optimum depth of sowing varies with crop, especially seed size and penetration power of plumule. For *e.g.*, it is 1–2 cm for sesamum, 2–3 cm for pearl millet and minor millets, 3–5 cm for pulses, sorghum and sunflower, 5 cm for cotton and maize, and 7 cm for coriander.

(e) **Method of sowing:** Sowing method is an important determinant of population. In dry lands, it is important to sow the seeds in moist soil layer to ensure proper germination and seedling emergence. It is therefore necessary to sow immediately after rainfall to avoid sowing in dry soil. It is also important to sow the seeds at correct depth, neither on the surface nor too deep. Establishment of an optimum population also depends on proper spacing between plants. The density, geometry, and depth of sowing are dependent on method of sowing. The sowing methods usually adopted in dry lands include broadcasting, sowing behind plough and sowing by seed drills. Dibbling of seeds and planting of seedlings are also adopted for some crops (Cotton, tobacco and chillies). Each method has advantages as well as limitations. The choice of sowing method depends on seed size, soil condition time available, cropping system, crop geometry, sowing depth, source of power, cost of sowing, etc. The merits and limitations of sowing methods are given in Table 13.13.

Table 13.13. Merits and Limitations of Sowing Methods

<i>Sowing method</i>	<i>Merits</i>	<i>Limitations</i>
Broadcasting	Quick coverage for small seeds like ragi, sesamum, minor millets, medium sized seed like sorghum pulses can also be broadcasted	Spacing and depth not ensured high seed rate-intercrop sown separately
Sowing behind plough	For medium and bold seeds cotton, sorghum, maize, groundnut, pulses, castor, sunflower seeding requires wooden plough only. Easy operation-row spacing can be ensured	Low coverage spacing between plants and depth of sowing not ensured. Intercrop has to be sown separately. Only monsoon sowing is possible
Local seed drill (gorru)	For medium and bold seeds wooden implement easy maintenance, less cost, row spacing is ensured, more coverage than broadcasting and sowing behind plough. Sowing depth and row spacing is uniform	Spacing between plants is not uniform and depends on experience of seed dropper. Intercrop has to be sown separately. Cannot be used for pre-monsoon sowing.
Mechanized seed drill (Bullock drawn/tractor drawn)	Large coverage, row and plant spacing ensured uniform depth of sowing. Base crop and intercrop sown simultaneously, enables early sowing in large area, and saves cost and time. Pre-monsoon sowing is possible.	Initial cost is high, needs skill for operation and maintenance.

(f) **Crop geometry:** It refers to the shape of land occupied by individual plants as decided by spacing between rows and between plants. It depends on the root spread and the canopy size of the crop and the cropping system.

Crop	Crop geometry (cm)	
	Sole crop in solid row	Intercropping
Sorghum	45 × 15	(60 + 30) × 15 in paired row
Pearl millet	30 × 15	
Ragi	30 × 10	
Small millets	30 × 10	
Black gram, green gram, Soybean, horse gram	30 × 10	
Red gram	60 × 30	
Cowpea	30 × 15	
Cotton	45 × 30	(60 + 30) × 15 in paired row
Cotton (<i>Arboreum</i>)	45 × 15	
Groundnut	30 × 10	
Sesamum	30 × 30	
Sunflower	45 × 15	
Sunflower hybrids	45 × 20	
Sunflower varieties	30 × 15	
Coriander	30 × 15	
Senna	45 × 15	
Maize	45 × 30	



Fig. 13.1 Seed cum fertilizer drill



Fig. 13.2 Ferti cum seed drill

13.7 SOIL FERTILITY MANAGEMENT UNDER DRY FARMING

“Dry land soils are not only thirsty, but also hungry.” Uncertainty of return from the investment on fertilizer use and the poor resource base are the reasons for not using fertilizer by the dry land farmers. The fertilizer use in dry land crops might vary between 5 and 40 kg/ha ($N+P_2O_5+K_2O$). Soils are low in N and P, and Zn is the most limiting factor among micronutrient. The response for Ca, Mg and S has also been recorded. The reasons for poor soil fertility are slow weathering of minerals, low organic matter content, reduced microbial activity, erosion, very low addition of manures and fertilizers, soil salinity and alkalinity, and reduced mobility of nutrients and nutrient fixation. The following Tables 81 and 82 gives the quantity of nutrient removed by dry land crops and nutrient requirement by dry land crops.

A. Beneficial Effect

The beneficial effects of nutrient supply in dry lands are given below:

- Deficiency in soil supply of nutrients required by crops is corrected.
- Nutrient supply promotes root development, which enables higher uptake of soil moisture and

- high water use efficiency. This positive relationship between nutrients and moisture is mutual.
- Increased vigour of a fertilized crop enables it to survive drought better than an unfertilized crop.

Table 13.14. Nutrient Removal by Dry Land Crops

<i>Crop</i>	<i>kg/t of yield</i>			
	<i>N</i>	<i>P₂O₅</i>	<i>K₂O</i>	<i>Total</i>
Sorghum	22.4	13.3	34.0	69.7
Pearl millet	42.3	22.6	90.8	155.7
Groundnut	58.1	19.6	30.1	107.8
Cotton	44.5	28.3	74.7	147.5
Bengal gram	46.3	8.4	49.6	104.3
Soybean	66.8	17.7	44.4	128.9
Red gram	62.0	11.5	65.0	138.5

Table 13.15. Nutrient Requirement of Dry Land Crops

<i>Crop</i>	<i>kg /q of produce</i>			
	<i>N</i>	<i>P₂O₅</i>	<i>K₂O</i>	<i>Total</i>
Pearl millet	3.73	0.99	4.89	9.61
Maize	2.00	0.92	3.00	5.92
Soybean	7.40	1.45	7.20	16.05
Red gram	6.20	1.15	6.50	13.85
Groundnut	6.65	2.12	4.39	13.16

Farmers in dry lands however do not apply sufficient quantity of nutrients since nutrient sources like manures and fertilizers are costly and risks to dependable crop production. The average consumption of inorganic fertilizers is less than 10 kg per ha in dry lands. Even this is confined to a few commercial crops like cotton, groundnut and chillies only. The reasons attributed by farmers for poor adoption of nutrient supply to rainfed crops include:

- High cost, inadequate availability of fertilizers and inadequate availability plus high cost of transport of organic manures, fear of scorching due to inorganic fertilizer addition.
- Low and uncertain yield, and income due to undependable rainfall behaviour.
- Apprehension that a well fertilized crop growing vigorously would exhaust soil moisture supply early and subject to moisture stress at later stages.
- Adoption of fertilizer non responsive varieties in large.

Due to the above reasons, nutrient supply in dry lands is at a slow pace. In order to ensure adequate nutrient supply, care must be taken to understand the factors that influence nutrient use efficiency in dry crops and to evolve an integrated nutrient management system that will be efficient, economical and environmentally sustainable.

B. Scope for Fertilizer Use

- Introduction of new high yielding varieties/hybrids in different crops which are fertilizer responsive at a given adequate soil moisture storage level.
- Development of new *in situ* soil moisture conservation methods enhances the duration time and depth of soil moisture availability. This will increase the fertilizer use efficiency. Hence, there is a good scope for fertilizer applications.
- Use of integrated nutrient management in different crops, increases the fertilizer use efficiency and increases the yield.
- Short duration/early duration varieties of crops utilize the fertilizers very efficiently than long duration varieties of the same crops.

C. Factors Influencing NUE

Nutrient use efficiency (NUE) refers to the yield per kg of nutrient applied. The response of rainfed crops to nutrient application depends on crop and variety, rainfall and soil moisture availability, soil properties, quantity, time and methods of nutrient application, cropping system adopted and management practices such as moisture conservation, timely weed control etc. The following Table 83 gives the response of rainfed crops to nutrients-nitrogen and phosphorus.

Table 13.16. Response Rainfed Crops to Nutrients

Crop	kg grain/kg of Nutrient	
	Nitrogen	Phosphorus
Sorghum	3.4–43.4	2.4–59.0
Pearl millet	2.1–24.8	1.7–14.3
Ragi	5.0–42.4	6.4–38.0
Maize	4.1–67.4	6.8–80.0
Thenai	5.9–17.9	–
Sunflower	1.5–22.6	1.2–2.0
Groundnut	1.3–6.0	1.2–15.0
Sesamum	1.3–5.0	1.1–3.1
Green gram	–	1.5–11.6
Black gram	–	1.8–6.7
Red gram	–	3.1–8.3

(a) **Rainfall and soil moisture availability:** Water and nutrients interact positively and exhibit a mutual complementary effect. Adequate and well-distributed rainfall enables higher nutrient uptake and response. This is accomplished through greater mobility of nutrients in a moist soil, improved microbial activity and better root growth. Under moisture stress, nutrient uptake suffers due to reduced mobility of nutrients, restricted root growth high salt concentration of soil solution, nutrient fixation and reduced microbial activity.

Nutrient supply improves water use efficiency through extensive root growth, reduced evaporation loss through canopy coverage of soil and higher yield. Information about rainfall quantity, distribution and probability, are very useful to make decisions on soil fertility management. If a region is defined

as one having a dependable onset of monsoon and hence adequate soil moisture for crop establishment, then basal dressing of fertilizer would be safe. If continuity and assurance of rainfall in early growth stage is present, then top dressing would be beneficial. Since, high intensity of rainfall is common in dry lands, split application of N would be advantageous to prevent loss through leaching. Information on rainfall probability could be used in scheduling fertilizer application to suit moisture storage capacity of soil profile and progress of rainfall during cropping season.

(b) **Crop and variety:** Crops and varieties vary in their ability to use applied nutrients. Hybrids and high yielding varieties (HYV) respond better than local varieties because of their high yield potential at the same level of resource supply. Among the crops, response to individual nutrients varies with species. Cereals and millets respond more to N, legumes to P_2O_5 and oilseeds to N, P_2O_5 and K_2O .

(c) **Soil properties:** Soil physical properties influence crop response mainly by affecting soil moisture availability. Soil nutrient status also has a significant effect on crop response. Dry lands are mostly deficient in N and so, there is universal response to N. Response to P_2O_5 depends on fixation in soil and to K on leaching loss.

(d) **Management practices:** Nutrient management aspects such as quantity, time and method of application of nutrients, inclusion of legumes in cropping system, soil moisture conservation practices etc. also influence crop response to nutrients.

D. Integrated Nutrient Management (INM)

The components of INM for rainfed crops are organic manures, inorganic fertilizers, biofertilizers and inclusion of legumes

1. Organic manures

Organic matter content in dryland soils is low and its improvement is essential to promote soil moisture storage and nutrient supply. This can be accomplished through addition of FYM/compost, green manure/green leaf manures and crop residues. Addition of FYM/compost at 12.5 t/ha is recommended. Incorporation of green manures/GLM before sowing or incorporation of intercropped legumes is useful. At Kovilpatti, Tamil Nadu, incorporation of sunn hemp not only reduced 50% N requirement but also sustained yield in cotton, sunflower and improved physico-chemical properties of soil. In Tamil Nadu, Kolinji and Aavarai (*Cassia auriculata*) are used as GLM in dry lands. Leaves of leguminous trees through lopping and prunings can serve as GLM e.g., Subabul, Vagai, Neem, Sisoo, Aacha.

2. Inorganic fertilizers

Quantity: Great care is required in deciding on the quantity because of high cost. It depends on soil, crop variety and moisture availability

Recommended dose of fertilizer application ($kg\ ha^{-1}$) to dry land crops of Tamil Nadu

Crop	N	P_2O_5	K_2O
Sorghum	40	20	070
Maize	135	62.5	50
Cumbu	70	35	35
Cotton	40	20	0
Sunflower	40	20	20
Pulses	12.5	2.5	0
Groundnut	17.5	35	53

Method of application must ensure application of nutrients in moist soil and prevention of loss. N can be applied basally at last ploughing and incorporated. Foliar application of N is useful when crops are reviving from stress. For P_2O_5 placement near root zone by basal incorporation or at 5–10 cm from seed rows is effective to prevent fixation and to ensure easy availability. To avoid fixation of applied P, application as enriched FYM is recommended. Deep placement is important for post rainy season crops grown on stored moisture. K is applied basally at last ploughing and incorporated. Micronutrients are applied after sowing but not incorporated. Use of seed cum fertilizer drill is very useful for placement of fertilizers

Time of application should be such to suit crop requirement and moisture availability. Since adequate moisture is always available at sowing, basal application is effective. N can be top-dressed at 25–30 DAS depending on rainfall. This enables skipping fertilizer if rainfall is not adequate and save the cost. For millets and cotton $\frac{1}{2}$ N and full P and K are applied basally and $\frac{1}{2}$ N is top-dressed. For other crops, full NPK is applied basally. For pre-monsoon sown crops like cotton and sorghum, entire P can be applied basally as enriched FYM. In case of sorghum, entire N can be applied at 30–35 DAS and for cotton, N can be applied in two equal splits at 20–25 and 40–45 DAS depending upon the receipt of rainfall during the corresponding period.

3. Legumes in cropping system

Legume intercropping is very common in dry lands. When a short duration legume is intercropped with a long duration non-legume, the legume haulms after picking pods can be incorporated to benefit the non-legume by current transfer of legume fixed N. In Sequential cropping, short duration legumes grown for grain/fodder as first crop, enrich the soil and the residual effect benefits the succeeding crop.

4. Biofertilisers

Seed inoculation of legumes with rhizobium, and seed inoculation and soil application with azospirillum for cereals, millets, cotton, sunflower and sesamum is recommended. Besides N fixation, azospirillum improves root growth through the exudation of growth promoting substances. Use of phosphobacteria as seed inoculation and soil application for solubilising native P is also recommended. VA mycorrhizae is found to play a crucial role in P nutrition of dry land crops especially soybean, sorghum and pearl millet. Biofertilizers constitute a low cost technology in nutrient management.

Management practices such as moisture conservation techniques, raising responsive varieties, timely weed control and emphasis on low cost and no cost technologies also play a vital role in nutrient management for dry land crops.

5. Low cost technology and non-monetary inputs in soil fertility management

Fertilizer is a costly input, compared with other components of dry land technology package. Considering the uncertainty and low level of returns in dry lands during years of abnormal rainfall, low cost technologies and non-monetary inputs relevant to soil fertility management must be given due importance. Seed inoculation and soil application of biofertilizers, use of enriched FYM, split application of N fertilizer, suitable method of application, choice of responsive cultivars and inclusion of legumes in intercropping are useful technologies in this regard.

13.8 CONTINGENCY CROP PLANNING FOR DIFFERENT ABERRANT WEATHER SITUATIONS

Rainfall behaviour in dry farming areas is erratic and uncertain. The deviations in rainfall behaviour include delayed onset, early withdrawal, intermediary dry spells during rainy season. The adverse effect

of these rainfall aberrations on crop growth vary with the degree of deviation and the crop growth stage at which such deviations occur. Suitable manipulations in crop management practices are needed to minimize such adverse effects of abnormal rainfall behaviour. These management decisions constitute contingency planning. Such management practices done after crop establishment and in the middle of growth are called midterm corrections.

<i>Rainfall aberration</i>	<i>Effect on crops</i>
Delay in onset of rainfall	Length of cropping season or cropping duration is reduced - crop sowing is delayed
Early withdrawal or cessation of rainfall	Moisture stress at maturity grain filling is affected (terminal stress)
Intermediate dry spells	
(a) Immediately after sowing	Germination is affected and population is reduced
(b) At vegetative phase	Affects stem elongation, leaf area expansion and branching or tillering
(c) At flowering	Affects anthesis and pollination, and grain/pod number is reduced
(d) At ripening	Grain filling and size is reduced

Contingency plan and midterm corrections vary with the type and time of occurrence of rainfall observation.

<i>Rainfall abnormality</i>	<i>Contingency plan and midterm correction</i>
1. <i>Delayed onset of rainfall</i>	
(a) Delay exceeding 3–4 weeks	Alternate crops of short duration to be sown
Delay in Southwest monsoon	
Normal–June	Groundnut
Delay–July	Ragi/pearl millet
Delay–August	Samai/Cowpea
Delay in Southwest monsoon	
Normal–October	Cotton/Sorghum
Delay–Early November	Sunflower/Pearl millet/Ragi
Delay–Late November	Coriander/Senna
(b) Delay of 1–2 weeks	Alternate varieties of short duration of same crop <i>e.g.</i> , Sorghum–for CO19 (150 days), CO 25 (110 days); Red gram–for local (180 days), CO 5 (130 days)
2. <i>Early withdrawal of rainfall</i>	Antitranspirant spray, harvesting for fodder (millets) and harvesting at physiological maturity
3. <i>Intermediary dry spell</i>	
(a) Immediately after sowing	Gap filling with subsequent rains if stand reduction is less than 20%. Re-sowing if stand reduction is more than 20%, mulching between crop rows. Stirring soil surface to create dust mulch to reduce evaporation

(Contd.)

<i>Rainfall abnormality</i>	<i>Contingency plan and midterm correction</i>
(b) At vegetative phase	Mulching, antitranspirant spray, spraying potassium chloride, thinning of 33–50% population
(c) At flowering	Antitranspirant spray, harvesting for fodder and ratooning with subsequent rains in millets (<i>e.g.</i>) sorghum
(d) At ripening	Antitranspirant spray, harvesting for fodder, harvesting at physiological maturity

A contingent crop plan-model for dry lands of Aruppukottai and Kovilpatti of Tamil Nadu is furnished below.

<i>Rainfall period</i>	<i>Aruppukottai</i>	<i>Kovilpatti</i>
Rain fall	810 mm	730 mm
On set of monsoon	37th standard week (2nd week of September)	41st standard week (2nd week of October)
Soil	Shallow vertisol	Deep vertisol
Premonsoon	35th standard week	39th standard week
Sowing	Last week of August	Last week of September
Crops	Cotton, Sorghum	Hirsutum cotton, Sorghum (K8), Fodder sorghum (K3)
Monsoon sowing	37th standard week	41st standard week
Choice of Crops	Cotton, Sorghum, Maize, Red gram, Black gram	Cotton (Hirsutum and, arboreum sp), maize, black gram, sorghum
2 Weeks delayed	39th standard week (last week of September) Maize, bajra	43rd standard week (last week of October) Sunflower, coriander
4 Weeks delayed	41st standard week (2nd week of October)	45th standard week (2nd week of November) Coriander, gingelly, Senna
6 Weeks delayed	43rd standard week (last week of October) Coriander	47th standard week (last week of November)Senna is possible if heavy rainfall is received

13.9 RESOURCE MANAGEMENT FOR SUSTAINABLE AGRICULTURE

Soil and water are two naturally available resources need to be managed efficiently in dry land agriculture. Under given ecological limitation, it is the rainfall variation that causes fluctuation in productivity from year to year. The following technologies may be followed for resource management.

- Effective utilization of stored soil moisture is important and hence crops and varieties having high moisture use efficiency (MUE) need to be used.
- Crop planning as per length of cropping season: Select the crop of proper duration to match the length of growing season for stabilizing in crop production.

A. Dry Land Horticulture

Fruit trees with drought tolerance potential can substitute annual crops in many dry land tracts. The criteria for selection of fruit trees for dry lands are drought tolerance, adaptability to varying soil conditions, flowering and fruiting during period of adequate moisture availability, quick regeneration after pruning and rapid recovery after stress is removed. The Table 13.17 gives an idea to go for fruit trees under different rainfall and soil type conditions.

Successful dry land horticulture depends on many cultural requirements *viz.*, selection of trees suitable for rainfall and soil, planting during monsoon season in one m³ pits, pot watering during hot months in the early establishment period of 2–3 years, pruning to reduce canopy during dry season and moisture conservation through vegetative barriers, large basins sloping towards tree trunk, crescent or saucer shape basins, mulching with dry leaves, straw or crop waste.

Table 13.17. Fruit Trees under different Rainfall and Soil Type Conditions

Rainfall (mm)	Fruit trees suitable
560–700 700–900	Ber, pomegranate, cashew sapota, pomegranate, jamun, amla Mango, cashew, custard apple, guava, fig.
Soil type	
Black soils	Ber, sapota, pomegranate, jamun, amla, wood apple
Red soils	Mango, cashew, custard apple (Annona), pomegranate, sapota, amla.

Inclusion of fruit trees in dry land farming systems can be done through:

- Pure horticulture:** Plantations of mango, cashew, guava etc.
- Agri horticulture:** Annual crops intercropped in between fruit trees. *E.g.:* Mango + Groundnut/samai/horse gram, ber + cowpea/green gram.
- Hortipasture:** Growing pasture grasses and legumes between fruit trees. *E.g.:* Ber/guava + *Cenchrus ciliaris* + *Stylosanthes*.

B. Integrated Farming Systems (IFS)

Integrated farming system (IFS) refers to the adoption of allied agricultural enterprises along with crop production in a mutually beneficial manner in the same farm holding. *E.g.*, Crop + sheep/goat, crop/sericulture, Crop + poultry, crop/tree + forage + livestock. IFS offers many advantages compared with annual cropping alone by increased farm income, stability in farm income, increased employment opportunities, balanced food to farm family, efficient use of resources and recycling of farm wastes.

Case studies in dry land IFS

(i) Black soils of Kovilpatti, Tamil Nadu

IFS	Crop + Live stock
(a) Crop (0.5 ha)	Cotton, sun flower, sorghum
(b) Fodder crops (0.5 ha)	<i>Cenchrus ciliaris</i> , fodder cumbu, fodder sorghum
(c) Livestock	2 Jersey milch cows

<i>System</i>	<i>Net income (Rs./Year)</i>
1. Crop	1636
2. Additional income from milch animal	2519
3. Organic matter recycled	1.2 t per year

(ii) Black soils of Aruppukottai, Tamil Nadu

IFS	Crop + trees + goat
Crop	Sorghum + cowpea, cotton + black gram
Fodder	Cenchrus grass + desmanthus
Fruit trees	Ber, custard apple, amla
Livestock	Tellicherry goats (5 female + one male)

<i>System</i>	<i>Net income (Rs/ha/Year)</i>	<i>Per day income (Rs/day)</i>	<i>Employment Generation (man days /year)</i>
Crop alone	3228	9	35
IFS	10417	29	131

(iii) Black soils of Coimbatore, Tamil Nadu

System	Crop + trees + goat in one ha
Crop	Sorghum + cowpea for fodder 0.2 ha; Leucaena + Cenchrus 0.2 ha
Trees	Acacia senegal 0.2 ha; Prosopis cineraria 0.2 ha
Livestock	Goats in deep litter system (5 females + one male)

	<i>Crop alone</i>	<i>IFS</i>
Net income (Rs/ha/ Year)	1919	5666
Additional income	-	3749
Employment (man day/year)	40	153
Per day profit (Rs.)	2.26	15.52

(iv) Red soils of Paiyur, Tamil Nadu

System	Crop + dairy
Crop	Ragi/samai /pulses
Livestock	3 Cows
<i>System</i>	<i>Per day income (Rs/day)</i>
Crop alone	Rs. 2.38
Crop + Dairy	Rs. 8.10

More details are given in the chapter cropping and farming system.

C. Integrated Dry Land Technology and its Components

A single technology in isolation will not give desired results. Adoption of all related technologies as an integrated dry land technology package alone will provide a synergistic effect and improve the crop productivity in dry regions. The various components of such an integrated dry land technology (IDLT) are the following:

- *In situ* soil moisture conservation
- choice of suitable crops and crop substitution
- selection of high yielding drought tolerant varieties
- cropping system to suit rainfall quantity, duration of rainy season and soil moisture storage
- tillage to conserve moisture
- establishment of optimum population
- soil fertility management
- crop protection against weeds, pests and diseases.

13.10 ALTERNATE LAND USE SYSTEM

Uncertain rainfall, poor soil conditions and low level of management has made annual cropping of field crops a non-remunerative enterprise in many pockets of dry lands. In some instances, cropping has been given up altogether and lands remain fallow and become wastelands overgrown with unwanted vegetation. To arrest this trend and to bring back the land under economically useful vegetation, alternate land use systems such as grasslands/pastures, agroforestry and horticulture are recommended. This has become necessary for the following reasons:

- Annual field crop production is nonviable and uneconomical in many years.
- Yield of field crops is low and fluctuates widely between years affecting stability and income.
- Continued use of the eroded and degraded lands under the present system of annual cropping may ecologically degrade the lands further affecting sustainability of the fragile eco-system in the dry lands, leading to the creation of wastelands.
- Alternate land use systems such as grasslands and tree culture are less risky, more productive and remunerative in these marginal lands. They will provide stability and sustainability.

The choice of an alternate land use system depends on the land capability. Most of the lands under dry farming tracts come under the land capability classes of III and above.

<i>Land capability class</i>	<i>Alternate land use recommended</i>
Class II	Dry land horticulture
Class III and IV	Agro-forestry/ley farming
Class V	Pastures/silvipasture/tree farming
Class VI	Range lands/wood lots

A. Pastures and Grasslands

Forage crops play an important role in dry land economy. They help to promote livestock husbandry to improve and stabilize income. Forage grasses and legumes are best suited for marginal lands and sub marginal lands, sloppy lands, eroded and degraded lands for soil and moisture conservation and for reclamation of wastelands.

B. Forage Crops

Forage crops for dry lands include:

Annual cereals	Sorghum, maize, pearl millet
Annual legumes	Cowpea, cluster beans (guar)

Perennial grasses	<i>Cenchrus ciliaris</i> (Anjan or Kolukkattai grass)
	<i>Cenchrus setigerus</i> (black kolukkattai)
	<i>Cenchrus glaucus</i> (blue buffel)
	<i>Dichanthium annulatum</i> (marvel grass)
	<i>Chloris gayana</i> (Rhodes grass)
	<i>Heteropogon contortus</i> (spear grass)
Annual grass	<i>Pennisetum pedicellatum</i> (Deenanath grass)
Perennial legumes	<i>Stylosanthes hamata</i> , <i>Stylosanthes scabra</i> (Stylo or muyal masal)
	<i>Macroptilium atropurpureum</i> (siratro)
	<i>Clitoria ternatea</i> (sangupuspham)
	<i>Desmanthus virgatus</i> (Hedge lucerne/velimassal)
	<i>Leuceana leucocephala</i> (subabul), berseem.

Forage crops can be introduced into the dry land farming system through any of the following ways:

- Grasslands or pasture with perennial grasses and legumes for grazing by livestock, cutting and stall feeding (cut and carry system) and hay or silage making.
- Strip cropping with alternate strips of grasses/legumes and annual crops.
- Ley farming where in perennial forage crops are grown in rotation with annual crops in 4–5 year cycle *e.g.*, *Stylosanthes hamata* (3 years)–sorghum (1 year)–castor (1 year).

C. Ley Farming

Ley farming offers the following advantages:

- Provision of fodder for cattle,
- Low risk system,
- Soil and moisture conservation,
- Enrichment of soil fertility,
- Prevention of soil compaction, and
- Control of perennial weeds.

D. Silviculture

Silviculture refers to the raising of trees. When trees are introduced into farms along with field crops, it is known agrisilviculture or agroforestry system. Trees provides many benefits to mankind. They play protective role by making available a variety of products for human consumption, for livestock and for industrial raw material needs. *E.g.*, fruits, nuts, fuel, fodder, timber, wood, wax, resin, etc. They also play a protective role through soil and moisture conservation, enrichment of soil fertility through nutrient recycling and protection of environment.

(i) Methods of tree cultivation

Block culture: Large area is planted with selected species of trees suitable for fuel, timber, wood or industrial use (multipurpose tree species). It is also known as wood lots or energy plantations when planted for fuel. *e.g.*, Eucalyptus, Acacia, Prosopis.

Staggered planting: Trees are grown scattered in the field with annual crops raised in the interspaces. Multipurpose tree species suitable for fuel, fodder, wood and timber can be planted at 20–50 trees per ha. *E.g.*, Acacia + fodder sorghum, Neem + pulses/sorghum.

Border trees: Trees can be grown along farm boundaries and field borders for economic use as well as boundary markers. *E.g.*, Palmyrah, Neem, Tamarind, Eucalyptus.

(ii) Different systems of tree culture

1. **Agrisilviculture (Agroforestry):** Trees and annual crops are raised in an intercropping system in the same field. Trees are planted at 5-8 m spacing and field crops are sown in the interspaces during rainy season. *E.g.*, Leucaena + sorghum/pearl millet/castor/pulses, neem/vagai + fodder sorghum/pulses.
2. **Silvipasture:** Leguminous fodder trees are raised with fodder grasses and legumes as intercrops. *E.g.*, acacia + cenchrus + stylosanthes, vagai/sisoo + cenchrus + stylosanthes.
3. **Alley cropping or hedgerow intercropping:** Annual field crops are grown in alleys formed by hedgerows of trees and shrubs. The trees or shrubs in hedge rows are cut back to short height (0.5–1.0 m) at sowing of annual crops with onset of rains and kept pruned during crop growing season to reduce shade effect and competition with field crops. The width of alley (space between hedges) is about 4–6 m. *e.g.*, leucaena or desmanthus as hedge row with sorghum, maize, pigeon pea and sunflower as intercrop. Alley cropping offers many benefits.

- Green fodder from hedgerows during dry season, and food and dry fodder from annual crops during rainy season.
- Off season rainfall is utilized by hedgerow trees or shrubs.
- Hedge rows check runoff and erosion when formed along contour or across slope.
- Loppings and prunings from hedgerows can be used as fodder, fuel wood or for mulching.
- Yield of crops raised in the alleys is improved due to better microclimate through reduction in temperature and wind speed, increase in humidity and reduction in evapotranspiration loss.

Success in alley cropping depends on alley width and height of hedgerows. Alley width of 5–6 m has been found to be effective. Low height of 45–50 cm is desirable. Usually one cutting of hedgerow shrubs at the time of sowing of annual crops and subsequent prunings at monthly interval during cropping season are optimal. During dry season, cutting is done depending on fodder requirement.

4. **Timber-Fibre system (TIMFIB system):** It involves growing trees and perennial fibre crops together. *E.g.*, Leucaena + agave.

(iii) Choice of trees for dry lands

Trees suitable for dry lands must have the characters like multipurpose tree species (fodder, fuel, timber, wood), adaptable to wide variations in soil and climate, rapid growth and withstanding against severe pruning.

13.11 WATERSHED DEVELOPMENT

Watershed is defined as a natural hydrological unit that covers a specific land surface area from which runoff passes through a common outlet. In simple terms, it implies a catchment or drainage basin from which water drains towards a single channel. It may extend over a few acres only or may cover thousands of acres. Watershed development approach aims at developing the entire area in the watershed

<i>Soil</i>	<i>Rainfall (mm)</i>	<i>Trees suitable</i>
Black soil	730–830	<i>Euclayptus viridis, Acacia nilotica, Leucaena leucocephala</i>
Black soil	510–760	<i>Acacia nilotica, Acacia auriculiformis, Acacia indica, Acacia planifrons, Leucaena leucocephala, Azadirachta indica, Ailanthus excelsa</i>
Red soil	570–830	<i>Leucaena leucocephala, Eucalyptus cameldulensis, Acacia auriculiformis, Acacia nilotica, Acacia senegal, Acacia holosericea, Acacia tortilis, Albizzia lebbeck, Prosopis cineraria, Hardwickia binata, Dalbergia sisoo, Azadirachta indica</i>
Red soil	380–500	<i>Prosopis cineraia, Albizzia lebbeck, Acacia nilotica</i>
Red soil	Less than 300	<i>Acacia nilotica, Acacia senegal, Acacia tortilis, Ziziphus jujuba</i>

including the cultivated and uncultivated area. It is therefore different from individual farm as unit for development. Watershed management is the integration of technology within the natural boundaries of a drainage area for optimum development of land water and plant resources to meet the basic minimum needs of the people in a sustained manner. It is also defined as the development and management of watershed resources in such a manner as to achieve optimum production without deterioration of resources base or disturbing the ecological balance. It is termed as “**Resource centered technology**” since it helps in assessment augmentation and optimal utilization of all the natural resources of land water and vegetation, it prevents deterioration of resources and at the same time, ensures sustained productivity of land to meet basic needs of people.

A. Need and Advantages

Watershed is an acceptable basic hydrological unit of planning for optimum use and conservation of soil and water resources. Here, development is not confined to agricultural land alone but covers the whole land area starting from the highest point of the watershed (ridge line) to the lower most point of outlet into the natural drainage stream at the bottom of the slope. It means every part of land including barren, sloppy and marginal lands being treated according to its capability. By adopting watershed as unit for development, different measures are adopted and executed in each of the topo-sequence according to its capability, providing an integrated treatment of arable and non-arable lands.

e.g.,

- Ridge line Tree culture
- Marginal land Agroforestry, pasture
- Arable land Integrated soil and moisture conservation and cropping

It aims at comprehensive development of all resources in the watershed *i.e.*, holistic. It starts from the most important resources *viz.*, soil and water and extends to other resources like crops trees, live-stock etc. Some of the resource conservation measures may have to be carried out cutting across field boundaries *E.g.*, Contour bunding, contour vegetative barriers, shelterbelts, drainage channel. For this, watershed is more ideal unit. It is a multidisciplinary approach involving scientists from all related disciplines of Agronomy, Engineering, Horticulture, Forestry, Soil Science, Extension, Economics, etc. It provides for involvement of farmers in planning execution and monitoring of the development.

B. Principles

The main principles of watershed management based on resource conservation, resource generation and resource utilization, are:

- Utilizing the land according to its capability;
- Protecting productive top soil;
- Reducing siltation hazards in storage tanks and reservoirs and lower fertile lands;
- Maintaining adequate vegetation cover on soil surface throughout the year, *in situ* conservation of rain water;
- Safe diversion of excess water to storage points through vegetative waterways;
- Stabilization of gullies by providing checks at specified intervals and thereby increasing ground water recharge;
- Increasing cropping intensity and land equivalent ratio through intercropping and sequence cropping;
- Safe utilization of marginal lands through alternate land use systems with agriculture, horticulture, forestry, pasture systems with varied options and combinations;
- Water harvesting for supplemental and off-season irrigation;
- Maximizing agricultural productivity per unit area per unit time and per unit of water;
- Ensuring sustainability of the ecosystem befitting the man, animal, plant, water complex;
- Maximizing the combined income from the interrelated and dynamic crop, livestock, tree, labour complex over years;
- Stabilizing total income and to cut down risks during aberrant weather situations;
- Improving infrastructural facilities with regard to storage, transportation and marketing of the agricultural produce;
- Setting up of small scale agro industries; and
- Improving the socioeconomic status of the farmers.

Objectives - Watershed management is enshrined with the concept of sustainability meeting the needs of present population without compromising the interests of future generations. It is multi-pronged approach for steady uplift of masses living in the area. The main objectives of this multipurpose programme can be described in symbolic form by the expression 'POWER'. Here the letters symbolize the following:

- P**— Production of food-fodder-fuel-fruit-fibre-fish-milk combine on a sustained basis; Pollution control; Prevention of floods
- O**— Over-exploitation of resources to be minimized by controlling excessive biotic interference like overgrazing; Operational practicability of all on-farm operations and follow-up programmes including easy approachability to different locations in watershed
- W**—Water storage at convenient locations for different purposes; Wild animal and indigenous plant life conservation at selected places
- E**— Erosion control; Eco-system safety; Economic stability; Employment generation
- R**— Recharge of ground water; Reduction of drought hazards; Reduction of siltation in multi-purpose reservoirs; Recreation

C. Components

- Water-resource improvement
- Soil and moisture conservation in cultivated lands

Hardware	Software
Permanent/Semi-permanent Contour builds Bench terracing Conservation ditches Land levelling Runoff collection structures	Temporary/Recurring Compartmental bunding Ridging after crop establishment Contour cultivation Mulching Vegetative barriers

- Land treatment in non-arable lands
- Improved cropping
- Alternate land use system and integration of livestock in farming system.

D. Aims

- Increased land productivity through improved technology
- Sustaining the resource base thorough improved conservation measures
- Augmentation of resource base viz., soil productivity and water availability

E. Action Plan (Steps in watershed development)

Step 1. Identification and selection of watershed

The boundary of the watershed has to be marked by field survey starting from the lowest point of the water course and proceeding upwards to the ridge line. The area may vary as low as 100 ha to as high as 10,000 ha.

Step 2. Description of watershed

Basic information has to be collected on—

- Location
- Area, shape and slope
- Climate
- Soil—geology, hydrology, physical, chemical and biological properties, erosion level
- Vegetation—native and cultivated species
- Land capability
- Present land use pattern
- Crop pattern, cropping system and management
- Farming system adopted
- Economics of farming
 - Manpower resource
 - Socio economic data
 - Infrastructural and institutional facilities

Step 3. Analysis of problems and identification of available solutions

Step 4. Designing the technology components

- Soil and moisture conservation measures
- Run off collection, storage and recycling

- Optimal land use and cropping system
- Alternate land use system and farming system
- Other land treatment measures
- Development of livestock and other allied activities
- Ground water recharge and augmentation

Step 5

Preparation of base maps of watershed incorporating all features of geology, hydrology, physiography, soil and proposed development measures for each part of watershed.

Step 6

Cost-benefit analysis to indicate estimated cost of each component activity, total cost of project and expected benefit.

Step 7

Fixing the time frame to show time of start, duration of project, time frame for completion of each component activity along with the department/agency to be involved in each component activity

Step 8

Monitoring and evaluation to assess the progress of the project and to suggest modification if any

Step 9

On-farm research to identify solutions for site-specific problems.

F. Organizational requirement

- Water shed development agency with multidisciplinary staff
- Training to personnel
- Training to farmers
- Credit institution
- Farmers forum/village association
- Non governmental organization (NGO)

Harvesting and Post Harvest Technology

Harvesting assumes considerable importance because the crop has to be harvested as early as possible to make way for another crop. Sometimes, harvesting time may also coincide with heavy rainfall or severe cyclone and floods. In view of these situations suitable technology is, therefore, necessary for reducing the harvesting time and safe storage at farm level. The post-harvest losses are estimated to be about 25 per cent.

Post-harvest operations are assuming importance due to higher yields and increased cropping intensity. Due to introduction of modern technology, yield levels have substantially increased resulting in a marketable surplus, which has to be stored till prices are favorable for sale. With increase in irrigation facilities and easy availability of fertilizers, intensive cropping is being practiced. A recent estimate by the Ministry of Food and Civil supplies put the total preventable post-harvest losses of food grains at about 20 million tons a year, which was nearly 10 per cent of the total production. The principal adviser, planning commission stated that food grains wasted during post-harvest period could have fed up 117 million people for a year.

Out of the total food grain production, more than 70 per cent is with the farmer and rest is stored by governmental organizations like central Warehousing Corporation and Food Corporation of India and Traders. The godowns are the most common structures for above ground bag storage. The godowns have all the facilities for fumigation, providing aeration and rat proof. Each of the godown can hold 5000 t of bagged food grains. Grain is also stored in bulk using large silos. For want of required storage space in godowns, food grains are also stored in the open and this method of storage is known as CAP storage. Cap stands for cover and plinth. Open spaces in warehouses and elsewhere are used for storing produce. Crates are placed on floor, mats are spread on the crates and finally bags are placed over the crates. The stacks are built in the form of domes. As protection against rain and sun the stacks are covered with thick (600 to 1000 gauge) black polythene sheets and the cover is tied to the stack with the help of plastic ropes.

14.1 HARVESTING

Removal of entire plant or economic parts after maturity from the field is called *harvesting*. It includes the operation of cutting, picking, plucking or digging or a combination of these for removing the useful part or economic part from the plants/crops. The portion of the stem that is left in the field after harvest is called as *stubble*. The economic product may be *grain, seed, leaf, root* or *entire plant*.

A. Harvest Index (H.I)

It is the ratio of the economic yield to the total biological yield expressed as percentage.

$$\text{H.I} = (\text{Economic yield/Biological yield}) \times 100$$

B. Time of Harvesting

If the crop is harvested early, the produce contains high moisture and more immature ill filled and shriveled grains. High moisture leads to pest attack and reduction in germination percentage and impairs the grain quality. Late harvesting results in shattering of grains, germination even before harvesting during rainy season and breakage during processing.

<i>Losses due to late harvesting</i>	<i>Percentage of loss</i>
Harvesting at physiological maturity	0.71
Harvesting at harvest maturity	3.50
Harvesting one week after maturity	5.63
Harvesting two week after maturity	8.64
Harvesting three week after maturity	14.70
Harvesting four week after maturity	16.40

Hence, harvesting at correct time is essential to get good quality grains and higher yield.

Time of harvesting can be assessed by (i) calculating the growing degree days (GDD), and (ii) assessing maturity from the duration of crop.

(i) **Growing Degree Days:** A degree day or a heat unit is the mean temperature above base temperature,

$$\text{GDD} = \sum_{i=i}^n \left[\frac{T_{\max} + T_{\min}}{2} \right] - T_b$$

where T_{\max} is maximum temperature, T_{\min} is minimum temperature. T_b is the lowest temperature at which there is no growth (base temperature). For example—base temperature of rice, maize and cumbu is 10°C whereas it is 4.5°C for wheat. Degree days are useful for predicting the time of harvest by calendaring the required photo thermal units (PTU) to complete each growth stage of the crop.

$$\text{PTU} = \sum_{i=i}^n (\text{GDD} \times \text{Length of day for long day plant or night for short day plant})$$

(ii) **Assessing Maturity:** Crops can be harvested by assessing the maturity *i.e.*, at physiological maturity or at harvest maturity.

(a) **Physiological maturity** refers to a development stage after which no further increases in dry matter occurs in the economic part. Crop is considered to be at physiological maturity when the translocation of photosynthesis to the economic part is stopped.

(b) **Harvest maturity** generally occurs seven days after physiological maturity. The important processes during this period is loss of moisture from the plants.

C. External Symptoms of Physiological Maturity

The major symptoms of physiological maturity of some field crops are as follows:

- *Wheat and Barely*–Complete loss of green colour from the glumes.
- *Maize and Sorghum*–Black layer in the placental region of grain
- *Pearl millet*–Appearance of bleached peduncle
- *Soybean*–Loss of the green colour from leaves.
- *Redgram*–Green pods turning brown about 25 days after flowering.

D. Harvest Maturity Symptoms

The harvest maturity symptoms of some important crops are as follows:

- Rice–Hard and yellow coloured grains.
- Wheat–Yellowing of spikelets.
- Sorghum, Pearl millet, foxtail millet–Yellow coloured ears with hard grains.
- Ragi–Brown coloured ears with hard grains
- Pulses–Brown coloured pods with hard seeds inside the pods.
- Groundnut–Inner side of the pods turn dark from light color.
- Sugarcane–Leaves turn yellow.
- Tobacco–leaves slightly turn yellow in colour and specks appear on the leaves.

E. Criteria for Harvesting of Crops

The criteria for harvesting of crops is given in Table 14.1.

Table 14.1. Criteria for Harvesting of Crops

<i>Crop</i>	<i>Criteria for harvesting</i>
Rice	32 days after flowering, Green grains not more than 4-9%
Wheat	About 15% moisture in grain, Grain in hard dough stage.
Maize	25–30 days after tasselling, Seed moisture content is at 34%
Sorghum	40 days after flowering
Cumbu	28–35 days after flowering
Redgram	35–40 days after flowering
Black/Green gram	Pod turn brown/black
Rapeseed/mustard	75% of the silique turn yellow, Seed moisture at 30%
Sunflower	Back of heads turns to lemon yellow
Groundnut	Yellowing of leaves and shedding Development of purple colour of the testa
Cotton	Bolls fully opened
Jute	50% pod stage (120–150 days)
Sugarcane	Brix 18–20%, Sucrose 15%

Determination of harvesting date is easier for determinate crops and difficult for indeterminate crops because at a given time, the indeterminate plants contain flowers, immature and mature pods or fruits. If the harvesting is delayed for the sake of immature pods, mature pods may shatter, if harvested earlier, yield is less due to several immature pods. This problem can be overcome by,

- harvesting pods or ears when 75% of them are mature (or)

- periodical harvesting or picking of pods
- inducing uniform maturity by spraying Paraquat or 2, 4-D sodium salt.

In fodder crops, toxins present in the crop, nutritive value, purpose of harvest (whether for stall feeding or for storage) and single or multi cut are also to be considered during harvest. Example—HCN toxin content in sorghum is high up to 30–45 DAS.

F. Methods of Harvesting

Harvesting is done either manually or by mechanical means.

- Manual:** Sickle is the important tool used for harvesting. The sickle has to be sharp, curved and serrated for efficient harvesting. Knife is used for harvesting of plants with thick and woody stems. Now-a-days improved type of sickle is available which reduce the drudgery of harvesting labourers.
- Mechanical:** Harvesting with the use of implements or machines.

G. Implements/Machinery used for Threshing and Drying

For harvesting: Power tiller operator paddy harvester, combine harvester, guntaka etc. are used.

- Paddy harvester:** It is used for non-lodging varieties. During operation, the nose of the harvester first enters into the standing crop and movement brings the crop between star projection of the wheel, then it cuts the standing crop. Capacity of this machine is one hectare per day. The width of the coverage for one movement will be 0.75 m. The power requirement is 3 H.P. The present cost of the unit will be Rs. 30,000 and operation cost is Rs. 260/ha including cost of two labourers.
- Combine harvester:** It is possible to harvest and thresh the produce simultaneously using combine harvester. It cuts the crop, separates the grain from straw, cleans it from chaff and dust and stores the grains in the storage tank. The combine harvester reaps 2–9 rows at a time depending on its size and is equipped with 8 to 10 H.P engine. The cutting operation is done by a reciprocating type of cutter bar with a speed of 800–900 strokes per minute. The cut portion is transferred to conveyor belt or plant form with the help of wheel. Threshing cylinders operating at a peripheral speed of 800–1200 stroked per minute are used for threshing. Grain and chaff are separated with the help of blowers.
- Guntaka:** Ground nut is harvested using heavy blade harrows called Guntakas—R.E. Guntaka.

For threshing: (i) Olpad thresher, (ii) Japanese rotary paddy thresher; (iii) multi crop thresher, (iv) rollers etc. are used.

- Olpad thresher:** It is used for wheat, barley, oats etc. It consists of 20 circular discs each 45 cm in diameter and 3 mm in thickness placed 15 cm apart in three rows run by pair of bullocks over the dried crop spread circularly on the threshing floor.
- Japanese paddy thresher:** It consist of a threshing drum, driving mechanism and a supporting frame. Main parts are wooden drum with peg-teeth all around its circumference. The diameter of the drum is about 43 cm to 76 cm. The thresher is operated by a single person with the help of a pedal. Threshing of paddy is done by holding the bundle of harvested material against the teeth of revolving drum.
- Multi-crop threshers:** Mechanical thresher commonly used for threshing major cereals, oil seeds and pulses. It is operated by an electric motor or oil engine. These threshers have provision

to control concave clearance and threshing drum and blower speed independently so as to reduce grain breakage and improve cleaning. Sunflower and safflower, which are difficult to thresh with traditional methods, can also be threshed by the multi-crop thresher.

- (iv) **Rollers:** Rollers made of stone are used to thresh grains from ears of millets like ragi, sorghum and cumbu. Ear heads are spread to a thickness of 20 cm in a circular fashion on a threshing floor and rollers are drawn over it by a pair of bullocks.

Drying is done either by using solar energy or by artificial heating (mechanical drying) of air and circulating it as in driers.

Storage - Harvesting of crop is seasonal, but consumption of food grain is continuous. The market value of the produce is generally low at harvesting time. So the grower need storage facility to hold a portion of produce to meet the feed and seed requirements in addition of selling surplus produce when the marketing price is favourable. Traders and Co-operatives at market centres need storage structures to hold grains when the transport facility is inadequate. The government also needs storage structures to maintain buffer reserves to offset the effects produced by the vagaries of nature. Hence, there is necessity to store the produce for different periods primarily for commercial reasons. The growers, processors, transporters and warehouse men have to develop storage facilities for proper storage of food grains, oilseeds, commercial crops like Chillies, vegetables and fruits etc., and seeds intended for sowing in the following seasons. An ideal storage facility should satisfy the following requirements:

- It should provide maximum possible protection from ground moisture, rains, insect pests, moulds, rodents, birds, fire, etc.
- It should provide the necessary facility for inspection, disinfection, loading, unloading, cleaning and reconditioning.
- It should protect grain from excessive moisture and temperature favourable to both insect and mould development.
- It should be economical and suitable for a particular situation.

H. Post Harvest Processing

Post harvest processing encompasses an array of handling and processing system from the stage of maturation till consumption of the produce and includes threshing, cleaning, grading, drying, parboiling, curing, milling, preservation, storage, processing, packaging, transportation, marketing and consumption systems.

The most important factor deciding the storability of the produce is moisture content of the produce. High moisture content invites pest and disease and induce pre-germination. Moisture content for safe storage of grains of most crops is about 14% (raw rice), 15% for parboiled rice, 12% for wheat, barley, other millets and pulses, 10% for coriander, chillies and 6% for groundnut, rapeseed and mustard.

I. Objectives

- To minimize post harvest losses which is around 10–25% in cereals and 20–30% in perishables.
- To get good quality products.
- To get maximum quantity of materials by way of proper PHT.
- To get value added products by way of processing.
- For proper utilization of water from food industries.
- To create employment opportunities.
- To eliminate or minimize the pollution.

II. Principles Involved-Rice

- (i) **Threshing:** Involves the detachment of grains from the panicle.
- (ii) **Drying:** Reduction of 12–14% or 8% by evaporation. *i.e.*, it involves heat and mass transfer operations simultaneously.
- (iii) **Parboiling:** Is a hydrothermal treatment followed by drying before milling for the production of milled parboiled grain. The most important change during parboiling is the gelatinization of starch and disintegration of protein bodies in the endosperm.
- (iv) **Milling:** Refers to the size reduction and separation operations used for processing of food grains into edible form by removing and separating the inedible and undesirable portions from them, Milling may involve cleaning/separating husk (dehusking), sorting, whitening, polishing, grinding etc.
- (v) **Storage:** Proper storage in storage structures is necessary to prevent the grains from storage pest and to maintain the quality of seeds.

III. Methods involved in Post Harvest Technology

The quantitative losses encountered at various stages are 1 to 3%, during harvest, 2 to 6% during threshing, 1 to 5% during drying 2 to 7% during handling 2 to 10% during milling and 2 to 6% during handling 2 to 10% during milling and 2 to 6% during storage. To overcome these losses the following improved practices can be adopted.

- (i) **Harvesting:** Paddy if not harvested at the optimum time, results in loss of quality and quantity. To reduce these losses, machines like combines and reapers are being introduced to harvest paddy at an appropriate stage.
- (ii) **Threshing:** Threshing, done by bullocks, tractors and by hand, result in poor drying, storage and milling. The multicrop threshers have been developed to reduce these losses.
- (iii) **Transport:** Poor transport facilities result in losses to the farmers, millers, and eventually food grain to the country, sometimes as much as 2–3 per cent. Good transport facilities should be used to minimize these losses. When once the grain is threshed and dried, it will be transported from the field to store houses by bullock carts, or tractors by the growers. Sometimes if the market price is favourable, the produce is disposed to the traders soon after drying. The disposal of the produce, either at the village or at the market yard is, however often closely connected with financial needs of the growers and sometimes indebtedness. The traders on purchasing, transport the produce to go-down, or shops for sale to the consumers. This transport mainly uses trucks *i.e.*, lorries. Government agencies like Food Corporation of India etc., transport the produce from one place to another place either by road or rail (waggon) for long-term storage and sometimes to export to other countries by sea (cargo). If the produce is not properly bagged and handled there will be some loss during transport.
- (iv) **Drying:** Sun drying methods cause more breakage of grain than other factor, resulting in low head yields and low milling yields. Moist paddy in storage deteriorates rapidly. With the introduction of heated air dryers, the losses can be reduced considerably.
- (v) **Storage:** Uncleaned wet paddy accounts for the largest losses during storage. This is followed by losses due to rodents, birds, mould, fungus, insects and pilferage. These losses can be minimized by storing in good storage structures.

Table 14.2. Moisture Content of Grains for Safe Storage

<i>Crop</i>	<i>Moisture content in %</i>
Paddy and raw rice	14
Parboiled rice	15
Wheat, barley, maize, millets, and pulses	12
Coriander, chillies, fenugreek	10
Groundnut pods, rape and mustard	6

A. Types of storage

Holding grain in bulk in underground is an age-old method of rural storage. Wheat, rice, sorghum, finger millet, etc., can be stored underground for a period of 2 years. These structures are simple underground dig-outs upto a depth of 5 m varying in sizes to hold from a small quantity upto 50 t. The pits are lined with brick or concrete so that moisture from walls and bottom does not damage the grain. At the time of filling a layer of straw is placed on all sides. After the pit is filled, straw is spread over the grain and then topped with a layer of soil. Insect infestation is less in the underground storage and it is cheaper over above ground storage structures. This underground structure is not suitable for high rainfall and high water-table areas. Further the grain stored underground has poor appearance and musty smell. Several types of above ground storage structures mentioned below are also in use in our country,

- (i) **Mud Bins:** The mud bins are made of unburnt clay mixed with straw with 1-3 inch thick wall and are oval, rectangular or circular. A small hole is provided at the base for taking out the grain and a larger hole is provided at the top for filling it with grain. Both the inlet and outlet holes are plugged while grain is stored.
- (ii) **Straw bins:** For storing paddy in humid zones, dried plants are used for making temporary structures, which after being filled with grain are further reinforced from outside by winding paddy straw ropes around the whole structure. Each structure holds 2-6 quintals of grain.
- (iii) **Bukhari bins:** This is a cylindrical structure and is made of mud and split bamboo's. The bin is always placed on a wooden or a masonry plat form to prevent its contact with the ground. The capacity may vary from 3–10 t.
- (iv) **Kothar type bins:** These bins are very much similar to a timber box placed on a raised plat form, which is generally supported on pillars. Both the floor and walls are made of wooden planks, where the tiled or thatched roof is placed over it as a protection against sun and rains. The capacity may vary from 9–35 t.
- (v) **Metal bins:** Bins made of steel, aluminium R.C.C. are used for storage of grains outside the house. These bins are fire and moisture proof. The bins have long durability and produced on commercial scale. The capacity ranges from 1 to 10 t. Silos are huge bins made with either steel, aluminium or concrete. Usually steel and aluminium bins are circular in shape. The capacity of silo ranges from 500 to 4000 t. A silo has facilities for loading and unloading grains.

The storage structures in rural areas are not ideal from scientific-storage point of view, as substantial losses occur during storage of grain from insect pests, moulds, rodents, etc.; keeping the requirements of the farmers in view the Indian grain storage institute (IGSI), Hapur with its branch at Ludhiana

and Hyderabad have developed several metal bins of different capacities for scientific storage of grain in rural areas.

B. Methods of storage

The grains are stored at three different levels, viz., at the producer's level (rural storage) trader's level and urban organizational storage. The urban organization uses modern facilities and structures like silos, warehouses and also undertaken periodical inspection, processing and treatment of grains for ensuring their quality during storage. Generally, there are two ways of storing grains *i.e.*, Storage in bags and loose or bulk storage. In the tropical regions, the grain is stored in bags. Storage in bags requires considerable labour, but the minimum investment is enough on permanent structures and equipment. The storage in bags has the advantage of being short-term storage. Bag storage can be done under a roof of Galvanized Iron sheets, a plastic covering where grain is intended for very early onward movement. Usually no control measures against insects are needed for short-term storage. If bag storage produce is intended for long time, the control measures have to be taken against insect pests. The bulk storage has an advantage of greater storage capacity per unit volume of space. Less labour is involved in loading and unloading and there is no need of investment in purchasing gunny bags. In bulk storage the insect infestation is also lower over bag storage. The grain can be kept for several years in bulk storage.

(vi) **Parboiling:** It is done by soaking the grain in large concrete tanks and steaming it in small kettles or Soaking and steaming grain in large metal tanks with a boiler. The old traditional methods of parboiling incur physical losses and excessive cost of operation. Modern parboiling technologies have been developed and widely accepted by millers with good success leading reduction in losses.

(vii) **Milling:** Traditional milling equipment has the lowest milling recovery. With modernization of rice milling industry and by replacing hullers with modern mills, the milling losses can be reduced.

The qualitative losses like change in colour, odour, vitamins, texture are due to over exposure to sun, fungal growth and insect attack. These losses can also be controlled by proper handling, drying and storage after harvest.

(viii) **Marketing:** In general most of the producers sell the grains at their door steps in villages, to avoid transport. At village level defective measures and weights are used by traders and also the prices paid to farmers are much lower than regulated market rates. Now-a-days farmers are encouraged to sell their produce in near by regulated markets, though some labour is involved in transport. In regulated markets some amenities are provided for sellers and the growers can secure maximum value for their produce. In market yards several methods like cover system, open system and auction system are adopted depending on the type of produce sold. Since the rural banking system is improved the farmers to a large extent they are out of clutches of greedy private money lenders who exert pressure to dispose produce for lower price. At present in some places the cold storage facilities are also available. Farmers can utilize these cold storage facilities for stocking their produce on payment of rent and the produce can be disposed when there is remunerative price in the market. Though several measures are taken by government the marketing of agricultural produce is facing problems and growers are not getting the reasonable price for their produce. If production exceeds demand, price declines until the market is cleared. Prices raise when production fell short. Responses to lower or higher prices occur in the next production cycle. Therefore, the acreage for a particular crop based on demand and the supporting prices for each commodity need to be monitored by the rulers based on demand and supply

studies. The government has to bring buyers and sellers together, develop price information systems, establish consistent grades and product quality standards for better marketing of agricultural produce at all times.

IV. Low Cost Post Harvest Technology

These are some of the technologies suitable for small farmers:

1. **Solar Dryers:** Drying is the cheapest mode of preservation of fruits, vegetables and other items like fish. Solar drying is practiced by mankind since times in memorable. This method of drying with solar energy is ideally practiced by many grape growers in Maharashtra to make Kishmish/Manuka/Bedana from grapes.
2. **Zero energy cold storage:** Many farmers cultivate fruits and vegetables, which are seasonal in nature. Produce of all the farmers come to the market yard at one go. As a result prices fall. There is a good technology catching up. This is Zero energy cold storage. Everybody knows water becomes cool in an earthen pot. The water oozing out of the pot gets evaporated. While this evaporation occurs, water inside the pot becomes cold this principle is called as evaporate cooling. This principle is used for zero energy cold storage. Just make a double walled room. Keep sand between the outer and inner wall. Keep the sand wet by watering. And your produce kept inside the inner room will be preserved longer. Government is giving subsidy to popularize this concept.
3. **Pickles:** Pickling is one of the cheapest process of preservation of fruits and vegetables. Common salt and spices are used in conventional pickles. The process of pickling does not need energy. The process is so efficient that many people make pickles in their houses, which last even two to three years. And that too without any chemical preservatives. Pickled items are preserved because of fermentation.
4. **Fruit juices:** We can make juice from various fruits like Mango, Pineapple, Grapes, Lemons, tomatoes and many types of local specialties like Kokam, Jamun etc. Even Banana and Guava juice can be made. Banana, which is considered as poor man's fruit in India is considered as rich man's fancy in countries like Korea and Japan. We can make pulps out of the juices and use in off-season.
5. **Preservations in salt solutions:** Keeping in salt solutions can preserve vegetables. This process can be used to prolong the shelf life of various vegetables like cabbage, okra, spinach etc. In this process vegetables are kept in salt solutions and bottled. While using, just wash the vegetables in water to remove salt solutions. Shelf life will vary according to various factors but you can prolong shelf life at least by one month in this process. Calcutta University has done considerable research in this field.
6. **Small-scale industry in farm:** Farmers cannot get price for their produce because they have to depend upon middlemen for marketing. There is a solution to the problem. You can start manufacturing ketchups, sauces of various types and also Paste of Garlic, Ginger, Chilly etc. With a small investment in machinery and building, a unit can work profitably. The unit may give employment to others with a small investment of only 10 lakhs.

It can be stated with more confidence that such low cost technologies are more successful because there is more involvement of entrepreneurs in their projects.

Agronomy of Field Crops and Biofuel Plants

The statistical data for field crops (area, production and productivity in India from 1950–2006; area, production and productivity of crops in major states) is given in the Annexure. We recommend the readers to refer annexure.

15.1 CEREALS–MAJOR

I. RICE (*Oryza sativa*)

It is the staple food crop for more than 60 per cent of the world people. In some countries, attractive ready to eat products, which have, long shelf life *e.g.* popped and puffed rice, instant or rice flakes, canned rice and fermented products are produced. Protein is present in aleuron and endosperm (6–9%) and average is 7.5%. Rice straw is used as cattle feed, used for thatching roof and in cottage industry for preparation of hats, mats, ropes, sound absorbing straw board and used as litter material. Rice husk is used as animal feed, for papermaking and as fuel source. Rice bran is used as cattle and poultry feed and defatted bran, which is rich in protein, can be used in the preparation of biscuits. Rice bran oil is used in soap industry. Refined oil can be used as a cooling medium like cotton seed oil/corn oil. Rice bran wax, a byproduct of rice bran oil is used in industries. Rice bran oil is available in the market in the name of Porna for edible purpose (no cholesterol).

A. Origin

De Candolle (1886) and Watt (1862) thought that South India was the place where cultivated rice is originated. Vavilov (1926) suggested that India and Burma should be the origin of cultivated crop.

B. Species

Rice belongs to genus *Oryza* and family Poaceae. The genus includes 24 species of which *O. sativa* and *O. glaberrima* are cultivated. *O. sativa* has three sub species viz., *Indica*, *Japanica* and *Javanica*.

- 1. *Indica*:** Indigenous to India. It is adapted to subtropical-tropical regions. In India, the varieties are very tall, photosensitive, lodging, poor fertilizer responsive, moderate filling and late maturing. The morphological differences between the varieties are very wide and awnless.
- 2. *Japanica*:** It is confined to subtropical temperate regions (Japan, China, and Korea). Varieties are very dwarf, erect, non-lodging, photo insensitive, early maturing, high yielding and fertilizer

responsive. The morphological difference between the varieties is very narrow and awnless. Hence, crosses were made between Indica and Japonica—first cross was ADT 27 during 1964.

- 3. Javanica:** It is a wild form of rice and is cultivated in some parts of Indonesia. Varieties are the tallest, erect, poor filling and awned.

C. Distribution

It grows from the tropics to subtropical and warm temperate countries up to 40°S and 50°N of the equator. Most of the rice area lies between equator and 40° N and 70° –140° E Longitude. Highest yield was recorded between 30° and 45°N of the equator. The average yield ranges from 2.0–5.7 t/ha in India, China and Egypt lying between 21° and 30° N. The countries near the equator show an average yield of 0.8–1.4 t/ha.

D. Area, Production and Productivity

In terms of area and production, rice is second to wheat. Maximum area under rice is in Asia (90%). Among the rice growing countries, India has the largest area (42.5 m.ha) followed by China, Bangladesh and Thailand. The area, production, productivity of rice for the world (continent wise) and some of the important countries is given in Tables 15.1 and 15.2.

Table 15.1. Area, Production and Productivity of Rice—continent wise (2004)

<i>Continent</i>	<i>Area (m.ha)</i>	<i>Production (m.t)</i>	<i>Yield (kg/ha)</i>	<i>Remarks</i>
World	153.26	608.50	3.97	The area under cultivation is high in Asia
Europe	0.59	3.38	5.69	
South America	5.80	23.17	4.00	The production is high in Asia
North central America	2.03	12.17	6.27	
Africa	10.22	19.22	1.88	The productivity is high in North Central America
Asia	134.54	549.46	4.08	

Source: www.irri.org

Table 15.2. Area, Production and Productivity of Rice—important countrywise (2004)

<i>Countries</i>	<i>Area (m.ha)</i>	<i>Production (m.t)</i>	<i>Yield (kg/ha)</i>	<i>Remarks</i>
India	42.50	124.40	2.93	The area under cultivation is high in India.
China	29.42	186.73	6.35	
Indonesia	11.75	53.60	4.52	The production and productivity is high in China
Myanmar	6.00	23.00	3.83	
Pakistan	2.21	7.57	3.43	
Thailand	9.80	25.20	2.57	

In India, rice accounts for about 22% of the total cropped area under cereals and about 31% of total area under food grains. It forms 41% of India's total output of the grain and forms roughly 46% of total output of the cereal. Projection of India's rice Production target for 2025 A.D. is 140 m.t which can be achieved by increasing the rice production by over 2.0 m.t/yr in the coming decade. The productivity has to be pushed up to 3.2 t/ha from the present level. India's position in production and productivity of major crops in the world is given in Table 15.3.

Table 15.3

Crop	India's share (%)		India's rank		Productivity	
	Area	Production	Area	Production	t/ha	Rank
Wheat	11.2	11.4	2	2	2.5	32
Rice	28.5	21.4	1	2	2.8	35
Pulses	36.6	26.0	1	1	0.6	118
Groundnut	35.2	28.6	2	1	1.0	50
Cane	20.0	22.6	2	2	65.9	34
Cotton	20.7	14.0	1	3	0.9	57

Rice growing areas in India can be grouped into 5 regions.

- Northeastern region:** This region comprises of Assam, West Bengal, South Bihar and Orissa. Rice is grown in the basins of Brahmaputra, Ganga and Mahanadhi rivers (known for the highest intensity of cultivation in the country). This region enjoys heavy rainfall and mostly rice is grown mainly under rainfed conditions.
- Southern region:** This region comprises of deltaic tracts of Godavari, Krishna, Cauvery and Tambraparani rivers and non-deltaic rainfed areas of Tamil Nadu and Andhra Pradesh. Rice is grown under irrigated conditions in the deltaic regions.
- West coast region:** This region comprises of Kerala and the coastal districts of Karnataka and Maharashtra. There is heavy rainfall during the monsoon period. Rice is grown under rainfed conditions.
- Central region:** This region comprises of Madhya Pradesh, Telengana region of Andhra Pradesh and parts of Karnataka. Rice is grown as rainfed crop by broadcasting in this region, except in Andhra Pradesh.
- Northern region:** This region comprises of Jammu and Kashmir, Punjab, Uttar Pradesh and North Bihar. These areas have low winter temperature and only a single crop of rice is raised from May-June to September-October.

Acreage : WB > UP > MP > Bihar > Orissa > AP
 Total Production : WB > UP > AP > Punjab > TN
 Average Yield : Punjab (3.39 t/ha) > Haryana(2.96 t/ha) > Tamil Nadu (2.69 t/ha)

The area, production and productivity of rice in different states of India are given in annexure.

In Tamil Nadu, rice research is being carried out in the following research stations of Tamil Nadu Agricultural University.

- Paddy Breeding Station (PBS), Coimbatore

- Tamil Nadu Rice Research Institute (TRRI), Aduthurai
- Agricultural College and Research Institutes at Madurai, Trichy and Killikulam
- Rice Research Stations at Tirur and Ambasamudram
- Agricultural Research Stations at Paramakudi, Ramanathapuram and Thirupathisaram

From these Research Stations, more than 150 varieties and 3 hybrids were released. The Tamil Nadu district wise area, production and productivity of rice is given in appendix.

E. Climate and Soil

Rice can be grown in different locations under a variety of climate. The Indica varieties are widely grown in tropical regions. Japonicas, which are adapted to cooler areas, are largely grown in temperate countries. Both Indica and Japonica rice varieties are grown in subtropical regions. However, the crosses between Indica and Japonica are grown through out the world. Rice needs hot and humid climate. It is best suited to regions, which have high humidity, prolonged sunshine and an assured supply of water. Temperature, solar radiation and rainfall influence rice yield by directly affecting the physiological processes involved in grain production and indirectly through diseases and pests.

(a) **Temperature:** Extreme temperatures are destructive to plant growth and hence depended on the environment under which the life cycle of the rice plant can be completed. The critical low and high temperatures for rice are normally below 20°C and above 30°C respectively, which vary from one growth stage to another. Temperature affects the grain yield by affecting tillering, spikelet formation and ripening and it influences the growth rate just after germination and increases almost linearly with increasing temperature within a range of 22–31°C. At later stages, it slightly affects tillering rate and the relative growth rate. During reproductive stage, the spikelet number per plant increases as the temperature drops. The critical temperatures for different growth stages of rice are given in Table 15.4.

Table 15.4. Temperature Requirement for different Stages of Rice Crop

Growth stage	Temperature °C		
	Low	Medium	High
Germination	10	45	20–35
Seedling and emergence	12–13	35	20–30
Rooting	16	35	25–28
Leaf elongation	7–12	35	31
Tillering	9–16	33	25–31
Panicle initiation	15	–	–
Anthesis	22	35	30–33
Ripening	12–18	30	20–25

(b) **Solar radiation:** The solar radiation requirements of rice crop differ from one growth stage to another. Shading during vegetative stage slightly affects yield and yield components. Shading during reproductive stage has a pronounced effect on spikelet number. During ripening, it reduces grain yield considerably because of decrease in the percentage of filled spikelets. Solar radiation at the reproductive stage has the greatest effect on grain yield. The minimum requirement of solar radiation is 300 cal/cm²/day.

(c) **Day length:** Rice is a short day plant. Long day prevents or delays flowering. *E.g.*, GEB 24 is a photosensitive and season bound variety. However the latest varieties released are photo insensitive.

(d) **Rainfall:** Under rainfed rice culture, rainfall is the most limiting factor in rice cultivation. When irrigation is provided, the growth and yield is determined by temperature and solar radiation. Water stress at any growth stage may reduce the yield. The rice plant is most sensitive to water deficit from the reduction division stage to heading.

(e) **Wind:** Moderate wind is beneficial for crop growth. High wind at maturity may cause lodging of the crop.

(f) **Soils:** Rice is a semi aquatic plant and grows best under low land condition. In India, it grows in all most all type of soils; alluvial, red, lateritic, laterite, black, saline and alkali, peaty and marshy soils, and in acid soils. But the soil having good retention capacity with good amount of clay and organic matter is ideal for rice cultivation. Clay and clay loam soils are most suited. It tolerates a wide range of soil reaction from 4.5–8.0. It grows well in soils having pH range of 5.5–6.5. It can be grown on alkali soil after treating them with gypsum or pyrites.

F. Rice Ecosystems

Based on land and water management practices, rice lands are classified as low land (wet land) and upland (dry land). In India, the principal systems of rice growing are

1. Dry system (upland)
2. Semi-dry system
3. Wet system (lowland)

1. Dry System or Upland Rice: In India, it is normally grown in eastern part of India *i.e.*, Assam, West Bengal, Orissa, Bihar, Uttar Pradesh and central part of India (Madhya Pradesh, part of Andhra Pradesh and Maharashtra). This system is called Aus in West Bengal, aus/ahu in Assam, beali in Orissa, bhadi or Kuari in Uttar Pradesh. In Tamil Nadu, it is mainly grown in Chengleput, Virudhunagar, Sivaganga, Nagapatinam, Thiruvallur, Kanchipuram, Pudukkottai and Kanyakumari districts. It is grown in areas where the rainfall is more than 850 mm and it is well distributed. In North India, it is mainly grown in SWM seasons and in Tamil Nadu, it is grown during NEM seasons/bimodal rainfall areas of Kanyakumari districts.

(a) **Field preparation:** The field is ploughed and harrowed to fine tilth taking advantage of summer rains and early monsoon showers. Application of gypsum at 1.0 t/ha is recommended whenever soil crusting and soil hardening problem exists. During the last ploughing, organic manures like FYM or compost at 12.5 t/ha is applied and incorporated.

(b) **Season:**

May-June in SWM area

August-September in NEM dominant area.

(c) **Varieties:** Varieties having 90-110 days are recommended.

- TKM 9: red rice, 100–105 days, short, bold grain, 5 t/ha.
- TPS 1: red rice, 110–115 days, short bold grain, 4.8 t/ha
- TPS 2: 125 days, non-lodging, 5 t/ha, suitable for kumbapu season
- TPS 3: 135 days, non-lodging, 5.3 t/ha, suitable for kumbapu season.
- MDU 5: 95–110 days, 5 t/ha, multiple resistant to pest and diseases.
- PKM 1: 110–115 days, dull white rice, pigmented, coarse grain and high protein, 3.2 t/ha.

(d) **Seed rate and seed treatment:** The seed rate is 75–100 kg/ha. The seeds are treated with fungicide like Bavistin or Thiram @ 2 g/kg of seeds, 24 hours before sowing and the seeds are treated with Azospirillum at 3 pockets (600 g) per ha of seeds.

(e) **Sowing:**

Broadcasting: The seeds are sown by broadcasting when the moisture is at the optimum level and the surface soil is compacted by a light roller for compacting the seeds with moist soil.

Line sowing: Line sowing is better than broadcasting. Sowing/dibbling behind the country plough or using seed drill to ensure optimum population, reduce the seed rate and for early intercultivation.

(f) **After cultivation:** Thinning and gap filling should be done 10–12 DAS, taking advantage of immediate rains.

(g) **Manuring:** In Tamil Nadu, P is applied at 25 kg/ha as enriched FYM at the time of last ploughing. N at 50 kg/ha and K₂O at 25 kg/ha should be applied in two splits viz. 20–25 DAS and the second at 40–45 DAS.

(h) **Weed management:** Under upland condition, weeds reduce the yield to the extent of 50%. First weeding should be done at 15–20 DAS and second weeding may be done on 45 DAS. Application of Thiobencarb at 2.5 l/ha or Pendimethalin at 3.0 l/ha on 8 DAS as sand mix may be done, if adequate moisture is available followed by one hand weeding on 30–35 DAS.

(i) **Intercropping:** Raising one row of black gram for every four rows of rice may be followed.

(j) **Special types:** A primitive type of shifting cultivation called Punam cultivation in Malabar, Kumari in South Kanara, Podu in Circars, Jhum in Assam hills is being done in scrub jungles on small scale. The bushes are cut and burnt. The land is ploughed with pre monsoon showers and rice is sown as pure or mixed crop. The land is abandoned after the harvest of rice and allowed to recoup its fertility. Fresh jungle land is broken up for cultivation every year.

2. Semidry Rice: It is practiced in the districts of Chengleput, Ramnad, Kanyakumari and Pudukottai district of Tamil Nadu.

(a) **Season:**

July–August	—	Chengleput and Kanyakumari districts
August	—	Thanjavur and Pudukottai districts
September–October	—	Ramanathapuram district

(b) **Varieties:**

Chengleput	—	TKM 9, IR 20, PMK 1, PMK 2, TKM 10 and TKM 11
Pudukottai	—	ADT36, PMK-1, PMK-2, TKM 9
Kanyakumari	—	TKM 9, ADT 36, ASD 17, TPS 1, TPS 2, TPS 3
Ramnad	—	TKM9, ADT 36, PMK 1, PMK 2, MDU 5.

(c) **Field preparation:** On the receipt of shower during the month of May-June, repeated ploughing should be carried out so as to conserve soil moisture, destroy weeds and break the clods. Application of FYM at 12.5 t/ha is recommended. Application of 750 kg of FYM enriched with 50 kg P₂O₅ can be applied as basal in clay soils.

(d) **Seed rate:** The seed rate is 80–100 kg ha⁻¹ and as in the case of upland rice, the seeds are treated with fungicide like Bavistin or Thiram @ 2 g/kg of seeds, 24 hours before sowing and the seeds are treated with Azospirillum at 3 pockets (600 g) per ha of seeds.

(e) **Sowing:** The sowing is done by broadcasting as dry crop and compacting with Gundaka or by drilling (sowing by seed drill at 20 cm row spacing). Whenever water is available after monsoon, it is

treated as wet paddy usually in July–August. When SWM is active, the rainwater is impounded in the fields. In command areas, anticipating the release of water, rice crop can be raised under semi dry condition up to a maximum of 45 days. Then the crop is converted into wet condition on receipt of water. In Chengelpat and Ramnad districts of Tamil Nadu, the crop is irrigated from 30–35 days onwards after impounding water in tanks.

(f) **After cultivation:** Thinning and gap filling should be done on 25–30th day after receipt of sufficient rain or impounding water in the field from the adjoining tanks.

(g) **Manuring:** Application of 100:50:50 kg N:P₂O₅:K₂O/ha is recommended. P₂O₅ at 50 kg/ha is applied as basal as enriched FYM. N is applied in three splits (50% N at basal, 25% at maximum tillering stage and remaining 25% at panicle initiation stage). K₂O is applied at 50 kg/ha as basal. The first top dressing should be done immediately after the receipt of sufficient rain or canal water.

(h) **Weed management:** Pre-emergence application of *Thiobencarb (Saturn 50 EC)* at 3.0 lit/ha (1.5 kg a.i./ha) or *Pendimethalin 4.0 lit/ha (stomp 30 EC)* on the 8 DAS as sand mix is recommended if adequate moisture is available, followed by one hand weeding on 30–35 DAS.

(i) **Harvest:** Timely harvest ensures good quality grain and prevents different losses. Harvest is done by using sickle, threshed and dried in the sun for 3–4 days up to 10–12% moisture for storage.

3. Wet system or low land rice: In India, low land rice is established by transplanting the seedlings in which separate nursery is raised (or) direct seeding of sprouted seeds in the puddled soil. For transplanting, the seedlings are raised in wet nursery, dapog nursery and dry nursery.

I. Transplanted rice

Wet nursery: The seed rate of 60 kg/ha is recommended for short duration, 40 kg/ha for medium duration and 30 kg/ha for long duration varieties.

A. Pre-treatment of seeds (before sowing)

(a) **Dry seed treatment:** Mix any one the fungicide at 2 g/kg of seed (Thiram, Captan, Carboxin or Carbendazim). Treat the seeds at least 24 hrs prior to soaking for sprouting. The seeds can be stored for 30 days without any loss in viability.

B. Treatment of seeds at the time of soaking the seeds for sprouting

(a) **Wet seed treatment:** Treat the seeds in Carbendazim or Pyroquilon or Tricyclozole solution at 2g/lit of water for 1 kg of seed. Soak the seeds in the solution for 2 hrs. Drain the solution, sprout the seeds and sow in the nursery bed. It gives protection to the seedlings up to 40 days from seedlings disease such as blast and it is better than dry seed treatment.

(b) **Seed treatment with Azospirillum:** Three packets (600 g/ha) of Azospirillum culture are to be mixed with sufficient water wherein seeds are soaked over night before sowing in the nursery bed. The bacterial suspension after decanting may be poured over the nursery area itself.

(c) **Seed treatment with Pseudomonas fluorescence:** Three packets (600 g/ha) of Pseudomonas culture should be added in water wherein seeds are soaked over night before sowing in the nursery bed. It can be mixed with *Azospirillum culture*, as it is not inhibitory to *Azospirillum*.

C. Soaking and sprouting the seeds

The seeds are soaked for 10 hrs. Drain the excess water. The seeds should not be soaked in running water, which removes the minerals and nutrients. Keep the soaked seeds in gunny bag in dark room and cover with extra gunnies for 24 hrs for sprouting. The seeds should not be covered with thick material, which develops heat and reduces the aeration.

D. Preparation of nursery for sowing

About 20 cents (800 m²) for planting one ha is required. Raise the nursery near the water source. Apply 1 t of FYM or compost to 20 cents of nursery and spread the manure uniformly. Before ploughing, allow water to a depth of 2.5 cm. Before last puddling, apply 40 kg of DAP @ 2 kg/cent. Basal application of DAP is recommended when the seedlings are to be pulled out in 20–25 DAS. If the seedlings are to be pulled out after 25 days, application of DAP is to be done 10 days prior to pulling out. In clayey soils, where root snapping is a problem, DAP has to be applied at 1 kg/cent 10 DAS.

Mark out plots, 2.5 m broad with channels, 30 cm wide in between. Collect the mud from the channel and spread on the seedbed and level the surface of seedbed so that water drains into the channel.

Having a thin film of water in the nursery, sow the sprouted seeds uniformly on the seedbed.

E. Water management

For water management in nursery, first drain the water 18–24 hrs after sowing and allow enough water to saturate the soil from 3–5th day. From 5th day onwards, increase the quantity of water to a depth of 1.5 cm depending on the height of seedlings. Afterwards, maintain 2.5 cm depth of water.

F. Weed management

Apply any one of the pre-emergence herbicide like Butachlor or Thiobencarb at 2.0 lit/ha or Pendimethalin at 2.5 lit/ha or Anilophos at 1.25 lit/ha on 8 DAS to control weeds in the nursery. Keep thin film of water at the time of herbicide application and should not drain the water after application.

G. Top dressing with fertilizers

If the seedlings show the symptoms of 'N' deficiency and if the growth is not satisfactory, apply urea at 500 g/cent of nursery, 7–10 days prior to pulling. If DAP is applied 10 days prior to pulling, urea application is not necessary.

H. Optimum age of seedlings for transplanting

Short duration varieties	: 18–22 days
Medium duration varieties	: 25–30 days
Long duration varieties	: 35–40 days

I. Main field preparation for transplanted rice

Wet rice requires a well puddled soil. Ploughing under submerged soil condition is called puddling. The land is ploughed repeatedly 3 or 4 times with an interval of about 4 days between each puddling by country plough or mould board plough or tractor drawn cage wheel or by using power tiller with a standing water of 3–5 cm. Optimum depth of puddling is 10 cm for clay and clay loam soils.

J. Application of organic manures

Apply 12.5 t of FYM or compost/ha and spread the manure uniformly on the dry soil before applying the water. If FYM or compost is not available, apply green manure/green leaf manure at 6.25 t/ha. Compute the green matter using the formula.

$$\text{Yield/m}^2 \text{ in kg} \times 10,000.$$

The yield of green manure is 10–15 t/ha for daincha, 8–15 t/ha for sunnhemp and 6–7.5 t/ha for Kolingi.



Fig. 15.1 Puddling rice field with power tiller

K. Incorporation of green manure

Stem nodulating S. rostrata can be grown during March- April. Adopt a seed rate of 50-60 kg/ha. Treat the seeds with rhizobial culture. Cut the crop at 45–60th day to have maximum green matter (25–30 t/ha).

Plough or incorporate the green manure or green leaf manure directly into the soil using mould board or tractor. Then, maintain 2.5 cm of water in the field. Incorporate the green manure to a depth of 15 cm using Burmese Saturn and allow to decompose for 7 days. When the green manure is applied, rock phosphate can be used as cheaper source of 'P'. It also harnesses the decomposition of stubbles in the second crop. Finally level the field using levelling board.

L. Transplanting

Puddle and level the fields after applying basal fertilizers. Seedlings are dibbled at desired spacing and depth. Plant density and geometry varies with soil fertility, genotypes and soils. To exploit the full potential of any genotype, optimum plant population is to be adopted. The depth of planting is 5–6 cm for clay soil and 2.5–3.0 cm for shallow soil.

Varietal duration	Low and medium fertility (Plants/ha)	Spacing (cm)	High fertility (Plants/ha)	Spacing (cm)
Short	8.0 lakhs	12.5 × 10	5.0 lakhs	20 × 10
Medium	5.0 lakhs	20 × 10	3.3 lakhs	20 × 15
Long	3.3 lakhs	20 × 15	2.5 lakhs	20 × 20

Number of seedlings/hill for wet nursery are 3–4 and it is 6–8 for dapog and 4–6 for saline soil. To manage aged seedlings, increasing basal N by 25% and the number of seedlings/hill is recommended. It is better to adopt closer spacing (80 hills/m²).



Fig. 15.2 Manual rice transplanter



Fig. 15.3 Rice manual random transplanting

Transplanting shock

It occurs when the seedlings are pulled out from the nursery and planted in the new environment. For recovery from shock, it will take minimum of 5–7 days under tropics.

- Shallow planting reduces the period.
- Mild temperature after transplanting also reduces the period.
- Hot weather period delays recovery.
- Very cold weather period also delays recovery.
- Best temperature: < 30°C maximum and > 20°C minimum.



Fig. 15.4 Manual rice line transplanting

N. Root dipping

In rice, root nematode is a problem. Dip the seedlings roots in the phosphomidon at 0.02% solution for 20 minutes prior to planting to avoid nematode problem.

For saline soils, use of saline tolerant variety is good. About 25 days old seedling instead of 18–22 days with 4–6 seedlings/hill can be planted. Apply 25% more ‘N’ than recommended dose and apply $ZnSO_4$ at 32.5 kg/ha (25% extra) at the time of planting.

O. Application of biofertilizer

1. **Azolla** is a water fern which is used as a biofertilizer for rice. Blue green algae, *Anabaena azolla* lives in the dorsal cavity of azollae which fixes ‘N’. It is also able to reduce the ‘N’ bill to the extent of 25–30 kg/ha. It is raised as a dual crop and also applied as green manure.
2. **Blue green algae:** Broadcast at 10 kg/ha of powdered blue green algae flakes 10 days after transplanting. Maintain thin film of water. BGA multiplies well from March to September and can be used for any rice variety raised during that period.



Fig. 15.5 Self propelled rice transplanter



Fig. 15.6 Nursery for rice transplanter



Fig. 15.7 Row rice transplanter

- 3. Dipping roots in Azospirillum slurry:** Prepare the slurry with 5 packets (1000 g/ha of *Azospirillum inoculant*) in 40 lit of water and dip the root portion of the seedling for 15–30 minutes in bacterial suspension and transplant the seedlings.
- 4. Soil application of Azospirillum:** Mix 10 packets (2000 g/ha of *Azospirillum inoculant* with 25 kg FYM and 25 kg of soil and broadcast the mixture uniformly in the main field before transplanting.

P. Water management

Among the cereal crops, the productivity per mm of water used is very low in rice, which is about 3-7 kg/ha mm of water. Total water requirement for rice is 1200–1500 mm which depends on the duration of crop, soil type and climate. At the time of transplanting, shallow depth of 2 cm is adequate, since higher depth of water results in reduction in tillering. Up to 7 days, maintain 2.0 cm of water. At establishment stage, 5.0 cm submergence of water has to be continued through out the crop growth period. For loamy soil, irrigation at one day disappearance of ponded water during summer, and 3 days after disappearance during winter may be done. For clay soil, immediately after disappearance during summer, and 1–2 days after disappearance during winter may be done. Critical stages for water requirement are: 1. Primordial initiation 2. Booting 3. Heading 4. Flowering stages. At boot leaf stage, excess water leads to delay in heading and reduction in growth of panicle. Stop irrigation 15 days ahead of harvest.

Q. Nutrient management

As far as possible, apply fertilizer as per soil test recommendation. If it is not followed, adopt blanket recommendation as follows in Tamil Nadu.

Varieties	N	P ₂ O ₅	K ₂ O
Short duration	120	38	38 kg/ha
Medium and long duration	150	50	50 kg/ha

All P₂O₅ and K₂O should be applied as basal at the time of puddling as quartering method only in course textured (low CEC), K may be applied in two splits 50% at basal and 50% at maximum tillering stage or panicle initiation stage. In clay soil, 'N' should be applied in three splits viz., 50% basal + 25% at max. tillering + 25% at panicle initiation stage. Application 25 kg of ZnSO₄ at the time of sowing is recommended and it should not be incorporated.

(a) **Nitrogen:** N will be lost by different ways; 1. Denitrification loss, 2. Fixation by microbes, 3. Leaching loss, 4. Volatilization loss, 5. Run-off, 6. Ammonium fixation, and 7. Crop uptake. Among the losses, denitrification and leaching losses are more in paddy soil under submerged due to low redox potential. To increase N use efficiency, the following methods may be followed:

- **Choice of fertilizer:** The choice of fertilizers is Ammonium Sulphate > Ammonium chloride > Ammonium sulphate nitrate > Urea > CAN. In India, 85% of production is urea due to less unit cost and most of the farmers are using urea.
- **Split application of 'N':** Application of N in 3–4 splits depending on soil type will increase NUE. If green manure is applied, skip basal application of N. Under this situation, 'N' as top dressing in 3 splits at 10 days interval between 15 and 45 days after transplanting is recommended for short and medium duration varieties.
- **Slow release fertilizer:** Use of chemically manufactured slow release N fertilizers to increase the NUE. *e.g.*, IBDU-Isobutylidene di urea and UF-Urea formaldehyde. Slow release by **Coated urea** with physical/mechanical means. *E.g.*, (a) sulphur coated urea, (b) neem coated urea, (c) gypsum coated urea, (d) mud ball urea etc.
- **Placement of urea super granules:** Bigger size urea super granules are placed directly into the reduced zone (below 10 cm depth) to avoid loss of N.
- **Use of nitrification inhibitors:** To control the conversion of NH₄ to NO₃ inhibiting the activity of nitrosomonas and nitrobacter. *E.g.*, AM, N-Serve etc., but these are not available in India.

(b) **Phosphorus:** It is essential for root growth, for early ripening, production of efficient and early tillers. Upland rice responds to more 'P' than low land rice, since submergence increases the availability of different forms of fixed 'P' in the soil. Nearly 80–90% of P is absorbed up to flowering:

- **Sources** - Single super phosphate (SSP) is the best source for normal and saline soils. Rock phosphate is the best source for acid soil.
- **Time and method of application:** Since 'P' is an immobile element and crop needs 'P' especially in the early stage, basal application at the time of puddling is superior than top dressing.
- **Rate of application:** 50 kg/ha for medium and long duration varieties and 38 kg/ha for short duration varieties is recommended. 'P' use efficiency can be increased with green manuring with addition of rock phosphate. When DAP is applied in the nursery, 1/3rd of recommended dose of 'P' can be applied to main field

(c) **Potassium:** Compared to N and P, rice absorbs more K. Potassium absorption is up to dough stage. Nearly 50–60% of K is absorbed from seedling to jointing stage (20–25 days). So, entire 'K' is applied as basal in clay soil. In light soils, K is applied in two splits viz. 50% basal and 50% at maximum tillering or panicle initiation stage. In some cases, K is applied with N in splits.

Source of K: K_2SO_4 is more effective, but unit cost is very high. Hence KCl is recommended.

(d) **Zinc:** It is more important for rice next to N, P and K. The deficiency occurs in sodic soils, alkaline soils, sandy soils and during continuous submergence. High amount of Ca and Mg reduces Zn uptake. Zn deficiency causes the physiological disorders like (1) Khaira disease and (2) Akagare–Type II. Akiuchi disease is due to toxicity of H_2S when high organic matter is present along with Fe toxicity. Zn deficiency can be corrected by dipping rice roots in 1% ZnO (Zinc oxide) or by basal application of $ZnSO_4$ at 25 kg/ha (only surface application and no incorporation). If basal application is not done, it is better to apply as 0.5% foliar spray at 20, 30 and 40 DAP for short duration varieties and at 30, 40 and 50 DAP for medium and long duration varieties.

R. Weed management

The weeds reduce the yield of transplanted rice by 15–20%. Crop weed competition is up to 20–30 days for short duration varieties and 30–40 days for long duration varieties after transplanting.

(a) Weed control measures

- **Through land preparation:** Summer ploughing and puddling reduce weed population.
- **Straight row planting:** It is more effective to operate rotary weeder or wheel hoe in between rows of crop. Now IRRI has developed single and double row Conoweeder, which can uproot and bury the weeds and are faster.
- **Flooding paddy at effective root depth:** Proper water management of 6–8 weeks submergence controls the weeds effectively. Aquatic and broad leaved weeds are not affected by this method.
- **Hand pulling/weeding:** It is laborious and is not economical.
- Weed control by **Chemicals** is quicker and less laborious. Large area can be covered in a short time with a limited amount of labour and it is cheaper. The disadvantages are
 1. No herbicide will kill all the species of weeds,
 2. Initial cost is higher.

(b) Integrated Weed Management (IWM)

- Use Butachlor 2.5 l/ha or Thiobencarb 2.5 lit/ha or Pendimethalin 3 lit/ha or Anilophos 1.25 lit/ha as pre-emergence application on 3 DAT as sand mix (50 kg of sand) followed by one hand weeding on 30–35 days after planting
(or)
- Use herbicide mixture: Pre-emergence herbicide mixture *viz.*, Butachlor 1.20 l/ha + 2,4 DEE 1.5 lit/ha (or) Thiobencarb 1.20 l + 2,4 DEE 1.5 lit/ha (or) Pendimethalin 1.5 l + 2,4 DEE 1.5 lit/ha as sand mix (or) Anilophos + 2, 4 DEE ready mix at 1.25 l/ha followed by one hand weeding on 30–35 DAT as sand mix will have a broad spectrum of weed control in transplanted rice.
- Maintain 2.5 cm of water at the time of herbicide application. Water should not be drained for 2 days (or) fresh irrigation should not be given.
- If pre-emergence herbicides are not used, 2,4 D sodium salt (Fernoxone 80% WP) at 1.25 kg/ha dissolved in 625 lit of water, is sprayed 3 weeks after transplanting using high volume sprayer.

S. Harvest and post harvest technology

(a) **Harvesting:** Harvesting is to be done at optimum time in the tropics, otherwise, there is loss of grain shedding, scattering, lodging and also damage by birds, over maturity and lodging. Timely harvesting

ensures good grain quality, a high market value and improved consumer preference/acceptance. In India, harvesting between 27 and 39 days after flowering gave maximum head rice recovery. The moisture content at the time of harvest is 18–20%. Taking the average duration of crops as an indication, drain the water from the field 7–10 days before the expected harvest as the drainage hastens the maturity and improves harvesting conditions. When 80% of the panicles turn straw colour (or) most of the grains at base of the panicle in the selected tillers are in hard dough stage, the crop is ready for harvest. Maturity may be hastened by 3–4 days by spraying 20% NaCl a week before harvest to escape monsoon rains.

(b) **Method of harvest:** Rice straw is usually cut with a sickle at 15–25 cm above the ground. In Indonesia and Philippines, only panicles are removed. Now, self propelled harvesters, reapers etc. are used for harvesting and combined harvester is available for harvesting, threshing, winnowing and cleaning the seeds.

(c) **Post harvest technology:** Post harvest technology encompasses an array of handling and processing system from the stage of maturation till consumption of the produce and includes threshing, cleaning, grading, drying, parboiling, curing, milling, preservation, storage, processing, packing, transportation, marketing and consumption system:

1. **Threshing:** The methods are generally classified as manual, animal or mechanical. The common method of separating grains from panicle is hand beating (hand threshing or using mechanical thresher (small or big thresher). A loss under manual threshing is 8%. IRRI designed a portable thresher. Most of the farmers are using mechanical thresher in the areas where labour availability is a problem.



Fig. 15.8 Paddy thresher

2. **Drying:** It is the process that removes moisture from the grain mass for safe storage and preservation of quality, viability and nutritive value. Drying should begin within 12 hours but not later than 24 hours after harvesting. Rice is normally harvested at moisture content of 20% or

more. If the moisture content is not reduced to below 14% shortly after threshing, the grain quality is deteriorated because of microbial activities and insect damage. The grains should be dried to 12–14% moisture level. In general, 4–5 days of seed drying are required.



Fig. 15.9 Manual threshing-rice



Fig. 15.10 Combine harvester

- 3. Winnowing and cleaning:** Presence of impurities like foreign seeds and trashes is more likely to deteriorate in storage and reduce milling recovery rate. Cleaning is mostly done by hand winnower, which takes advantage of wind for removing impurities. Now mechanical winnower is available. Combine harvester is a multipurpose one, which is useful for harvesting, threshing, winnowing and cleaning in one operation. It is highly profitable and economical.



Fig. 15.11 Tractor mounted conveyor reaper

- 4. Grading:** The grains are graded for uniformity in size, shape and colour. Seed cleaner cum graders are also available for effective cleaning and grading.
- 5. Storage:** Low temperature and low moisture are necessary for long-term storage of rice for seed. Rice seed of 10–14% moisture content can be stored in good condition at 18°C for more than 2 years.

(d) Rice processing:

- 1. Parboiling:** In this process, rough rice is soaked, steamed and redried before milling. The advantages of parboiling are: 1. Easy dehusking, 2. low incidence of pests and diseases 3. by milling of raw rice, 80% of fat and 18% of crude protein are lost, but starch increases by 5%.
- 2. Curing:** The new rice has low swelling capacity and has the tendency to yield a thick viscous gruel during cooking. To overcome the above defect in newly harvested paddy, methods have been developed to hasten the ageing in fresh rice and such process is called as curing. Steaming for 15–20 minutes is sufficient to bring satisfactory curing effect.
- 3. Milling:** Rice milling involves the removal of husks and bran from rough rice to produce polished rice. Time of harvest and season may affect the milling yield of rice.
- 4. Polishing:** Removal of very fine bran (often called whitening) 2–3 times.

II. Wet seeded rice/Direct seeding

The varieties recommended for different seasons, main field preparation—puddling, application of organic manure/green manure, seed treatment and sprouting of seeds are similar to that of transplanted wet rice.

- (a) Seeds and sowing:* The seed rate is 75 kg/ha. Sprouted seeds are sown in lines using drum seeder. It is more economical and labour saving. Cost of drum seeder is Rs. 2000/-. Maintain thin film of water at the time of sowing.



Fig. 15.12 Direct rice seeder



Fig. 15.13 Rice cum daincha seeder

- (b) **Nutrient management (kg/ha):** Application of 100: 50: 50 kg of N, P_2O_5 and K_2O respectively is recommended for the short duration crops raised in Kar/Kuruvai sornavari seasons. 50% N should be applied at 20 DAS and the remaining 25% N each at maximum tillering and panicle initiation stage. $ZnSO_4$ at 25 kg/ha is applied as basal. Application of Azolla at 1.0 t/ha at 15 DAS and then incorporation on 3rd week after application is recommended. For light soils,

potassium can be applied in two splits *viz.*, 50% basal and 50% at tilling/panicle initiation. In general, P and K are applied as basal.

- (c) **Water management:** Maintain thin film of water at the time of sowing. Drain the water, where the water is stagnating. Allow enough water to saturate the soil from 3 to 5 days. From the 5th day onwards, increase depth of water to 1.5 cm. Then afterwards, maintain 2.5 cm of water up to tillering. Then, maintain 5.0 cm of water throughout the crop growth. Stop irrigation 10 days before harvest.
- (d) **Weed management:** The most critical period is 15-30 DAS. Conventional method is hand weeding thrice at 20, 40 and 60 DAS. For effective weed control, IWM is recommended. Pre-emergence application of Pretilachlor at 0.45 kg a.i./ha (Sofit 50 EC) or Thiobencarb at 1.25 kg a.i./ha (2.5 lit of commercial product–saturn 50 EC) on 6–8 DAS followed by one late hand weeding on 40th day. Pre-emergence application of pretilachlor 0.3 kg a.i./ha + safner is more effective for control of weeds in wet seeded rice followed by one hand weeding. Butachlor 1.25 kg a.i./ha + Safener + one hand weeding may also be followed.

T. Hybrid rice

With an advent of cytoplasmic male sterile lines, China released first hybrid during 1976. More than 100 hybrids have been released in China. But out of 33.0 m.ha, only 17.6 m.ha is under hybrid rice. From 33.0 m.ha, China produces about 197 m.t. of rice. India so far produced 9 rice hybrids and the details are given in the Table 15.5.

Table 15.5. Rice Hybrids

S.No.	Hybrid	Year of release	Duration (days)	Average yield (t/ha)
1.	CORH 1	1994	110-115	6.08
2.	APRH 1	1994	130-135	7.14
3.	APRH 2	1994	120-125	6.02
4.	KRH 1	1994	125-130	7.49
5.	CNRH 3	1995	125-130	7.49
6.	KRRH 1	1996	125-130	7.30
7.	KRH 2	1996	130-135	7.40
8.	ADRH 1	1998	110-115	6.43
9.	CORH 2	1998	120-125	6.07

Hybrids recorded additional yield ranges from 0.85 to 2.3 t/ha compared to check. Private companies *viz.*, Boro, Agro, Pioneer etc., released 8 hybrids. The success of hybrid rice cultivation in India depends on the success of seed production. The seed production programme should be efficient and economic. So far, India could achieve seed yield of 1.5-2.0 t/ha as against China which recorded higher average yield of 2-3 t/ha for Indian hybrid and 3.6 t/ha for Japonica hybrid.

Tamil Nadu Hybrids

Hybrids: CORH 1, CORH 2 and ADTRH 1.

Season: CORH 1 and ADTRH 1 : Kar, Kuruvai, Sornavari; CORH 2: Samba, Late Samba, Navarai.

Seed rate: All hybrids : 20 kg/ha (1 kg/cent).

Seed treatment: Carbendazim at 2 g/kg of seed. Seed treatment with Azospirillum and *Phosphobacteria* each 3 pockets (600 g/ha) may also be done.

Nursery: FYM/compost at 1 t/20 cents or 500 kg green manure, DAP 2 kg/cent at last ploughing is applied. To control weeds in the nursery, Butachlor/Thiobencarb at 200 ml/20 cent or Anilphos 100 ml/20 cent 8 DAS as sand mix is recommended.

The seedling age is 25 days for CORH 1 and ADTRH 1 and 25-30 days for CORH 2.

Main field preparations and weed management techniques are similar to that of wet transplanted rice. For planting, one seedling/hill is planted with a spacing of 20 × 10 cm (50 plants/m²). The planting depth is 2-3 cm.

Fertilizer schedule: For CORH 1 and ADTRH 1, application of 150: 50: 50 kg of N, P₂O₅, K₂O kg/ha is recommended. Apply 50% N, and 100% P and 50% of K as basal. Remaining 50% N should be applied in 3 splits viz. 15, 30 and 45 DAT and remaining 50% of K should be applied at 30 DAT. For CORH 2, application of 150:60:60 kg of N, P₂O₅, K₂O kg/ha is recommended. Apply 50% N, 100% P and 50% K as basal, Remaining 50% N should be applied in 3 splits viz., 15, 40 and 60 DAT and remaining 50% of K at 40 DAT. Application of ZnSO₄ at 25 kg/ha as basal is recommended for the both the hybrids.

Irrigation: Irrigate at 5 cm depth of irrigation. Stop irrigation 10 days before harvest.

Critical stages: Panicle initiation (50 days) and heading (75-80 days).

Harvest: Harvest when 80% of panicles turn yellow.

Yield: The expected yield for ADTRH 1 is 6.4 t/ha and for CORH 2, it is 6.1 t/ha.

U. Super rice

Super rice is a plant type to raise the harvest index to around 0.6 and the biomass to 22 t/ha. Such a plant type is expected to have a yield potential of 13 t/ha. To achieve these objectives, the new plant type should have lower tillering capacity of producing 3–4 tillers when direct seeded and 8–10 tillers when transplanted and all other should be ear bearing. Each panicle should have 200–250 grains and plants with sturdy stem should grow to the height of 90–100 cm. It should have multiple disease and insect resistance and produce grain of acceptable quality.

V. Rice based cropping systems

In North Eastern part of India, rice is grown under rainfed condition. The different rice based intercropping systems followed under rainfed condition are given below:

Rice + Pigeon pea

Rice + green gram (moong bean) at 3:1 or 4:1 ratio

Rice + Black gram (urd bean)

In Tamil Nadu, Rice + Black gram at 3:1 ratio is followed

W. Ratooning in Rice

Ratooning is the cultivation of crop regrowth. Rice ratooning is common in USA, but not in India.

Varieties suitable

1. Bhavani : 4.0 t/ha. It yields 58% of main crop yield.
2. Other varieties : CO 37, ACM 8, ACM 10, ADT 36, ASD 16, PMK 1.

Stubble height: 20 cm stubble height.

Nutrient response: Ratoon crop responds well up to 120–150 kg N/ha. Application of complete basal fertilizer immediately after harvest of plant crop registered higher yield than split application.

X. Aerobic rice

Water in irrigated rice production has been taken for granted for centuries, but the “looming water crisis” may change the way of rice production in the future. Water saving irrigation technologies that were investigated in the early 1970s, such as saturated soil culture and alternate wetting and drying, are receiving renewed attention from researchers. These technologies reduce water input, though mostly at the expense of some yield loss. Farmers in Asia who confront scarcity or high costs of water have already started to adopt these technologies.

Aerobic rice is a new concept to further decrease water requirements in rice production. It is commercially grown in Brazil and is being pioneered by farmers in northern China. In the heart of the rice-wheat belt in India (Haryana, Punjab and Uttar Pradesh), innovative farmers have begun to grow rice aerobically under furrow irrigation in raised bed systems. Over the centuries, lowland rice has proven to be a remarkably anaerobic character. The shift from anaerobic to aerobic systems will have major consequences for weed, disease and pest management, nutrient and soil organic matter dynamics, and green house gas emission and sequestration. Weed control is an especially crucial issue in most water-saving irrigation technologies.

Concept: A fundamental approach to reduce water inputs in rice is to grow the crop like an irrigated upland crop such as wheat or maize. Instead of trying to reduce water input in lowland fields, the concept of having the field flooded or saturated is abandoned altogether. Upland crops are grown in non-puddled aerobic soil without standing water. Irrigation is applied to bring the soil water content in the root zone up to field capacity after it has reached a certain lower threshold (*e.g.*, halfway between field capacity and wilting point). Since it is not possible to apply irrigation water to the root zone only, some of it is lost by deep percolation and is unavailable for uptake by the crop. Typical field application efficiencies vary from 60-70% using surface irrigation (*e.g.*, flash or furrow irrigation) to more than 90% using sprinkler or drip irrigation. Evaporation can also be reduced with this technique, since there is no continuous standing water layer.

Areas to be grown under aerobic rice

The aerobic rice can be raised in the areas:

- Where rainfall is insufficient to sustain lowland rice production (estimated to require 1,200–1,500 mm) but thought to be sufficient for aerobic rice (estimated to require some 800 mm). Here, maize is the dominant crop and rice is an attractive alternative through the benefits of crop diversification.
- In pump-irrigated areas where water has become so expensive that lowland rice production was abandoned.
- Where water is scarce during the first part of the growing season (necessitating irrigation), but floods occur in the second part, upland crops such as maize and soybean cannot withstand flooding, but aerobic rice can.

Y. System of rice intensification (SRI)

SRI involves the use of certain management practices, which together provide better growing conditions for rice plants, particularly in the root zone, than those plants grown under traditional practices. SRI was developed in Madagascar in the early 1980s by Father Henri de Lauhanie, a Jesuit priest. In

1990, Association Tefy Saina (ATS) was formed as a Malagasy NGO to promote SRI. It has since been tested in China, India, Indonesia, Philippines, Sri Lanka and Bangladesh with positive results. Most rice farmers plant fairly mature seedlings (20-30 days old), in clumps, fairly close together with standing water maintained in the field for as much of the season as possible. These practices seem to reduce the risk of crop failure. It seems logical that more mature plants should survive better, that planting in clumps will ensure, that some seedlings should result in more yield; and that planting in standing water means the plants will never lack water and weeds will have little opportunity to grow. There are six practices in SRI.

1. **Young seedlings:** Seedlings are transplanted early. Rice seedlings are transplanted when only the first two leaves have emerged from the initial tiller or stalk, usually when they are between 8 and 15 days old. Seedlings should be grown in a nursery in which the soil is kept moist but not flooded. The seed sac should be kept attached to the infant root, because it is an important energy source for the young seedlings. The young seedlings should be planted so carefully that the root tip is not left pointing upward.
2. **Single seedling:** Seedlings are planted singly rather than clumps of two or three or more. This means that individual plants have room to spread and to send down roots. They do not compete as much with other rice plants for space, light and nutrients in the soil.
3. **Wider spacing:** Seedlings are planted in a square pattern with plenty of space between them in all directions. Usually, they are spaced at least 22.5 cm × 22.5 cm. It helps for vigorous root growth and more tillering. The square pattern facilitates *in situ* incorporation of weeds by Conoweeder.
4. **Lesser seed rate:** SRI method requires much lower seed rate (5–8 kg/ha) than traditional methods (75–100 kg/ha).



Fig. 15.14 SRI—Using conoweeder

5. **Moist but unflooded soil conditions:** Rice has traditionally been grown in water under submerged condition. In SRI method, soil is kept moist but not flooded during the vegetative period, ensuring that more oxygen is available in the soil for the roots, occasionally the soil should be allowed to dry to a point of cracking except in saline soils. This will allow oxygen to enter the soil and also induce the roots to grow and search for water. In SRI method, unflooded condition

is only maintained during vegetative period and from flowering to harvest, 1-3 cm of water is kept in the field as is done in the traditional method.

6. **Conoweeding:** Weeding can be done by conoweeder. The cost of conoweeder will be around Rs. 800–1500/- depending upon the type and materials used. First weeding should be done on 14 DAT and this should be continued up to 40 days at 7–10 days interval. At least two or three weeding is recommended. This practice seems to improve the soil structure and increases the soil aeration. Thus, the incorporation of weed biomass into the soil results in enrichment of CO₂ near to root zone, increases the biological activities, increases soil microbes population and activities, results in better nutrient availability in soil and uptake by plants. If conoweeder is not available, rotary weeder can be used.

2. WHEAT (*Triticum aestivum* or *T. Vulgare*)

Wheat is world's most widely cultivated food crop. It is a rabi (winter) season crop. In India it is the second important staple cereal food. It is mostly eaten in the form of chapaties. Wheat is also used for manufacturing bread, flakes, cakes, biscuits etc. Wheat straw is a good source of feed for cattle. Wheat contains more protein (8–15%) than in other cereals. Wheat proteins are of special significance. The protein contained in wheat includes albumins, globulins, glutinous and gliadines. Albumins dissolve in water. The other protein forms are insoluble in water and are called gluten. The gluten content in wheat is the highest (16–50%). Because of gluten, wheat flour is used for baking bread.

A. Origin

De candolle—Euphrates and Tigris and spread from there to China, Egypt and other parts of the world. Vavilov—Abyssinia and the whole group of soft wheat originated in the region of Pakistan, Southwestern Afghanistan and the southern parts of mountainous Bokhara.

B. Area and Distribution

	Area (m.ha)	Production (m.t.)	Productivity q/ha
World–2003–04	217.2	2.84	161.9
India–2003–2004	26.6 (12%)	2.71	72.1
India–2004–2005	25.5	2.76	73.03

At present, India produces more than 72 m.t. of wheat, which is 11 times higher relative to the same during 1950–51. Productivity is almost equal to that of global. In India, it is cultivated in Uttar Pradesh (25.6 m.t.), Punjab (14.5 m.t.), Haryana (9.1 m.t.), Madhya Pradesh (7.2 m.t.), Rajasthan and Bihar. The productivity is high in Punjab and Haryana (4–4.2 t/ha). India is expected to produce 109 m.t. of wheat by 2020 A.D. with annual rate of increase in production of about 2.2% while present rate of increase is about 1.0 per cent.

C. Classification of Wheat

1. **Emmer wheat (*Triticum dicoccum*)** - It is grown in Spain, Italy, Germany and Russia. It was developed from *T. diccoides* koru., a wild form. In India, it is grown in Maharashtra, Tamil Nadu and Karnataka.
2. **Macaroni wheat (*Triticum durum*)** - It is grown in Italy, USA, Canada, and Russia. They are descended from emmer wheat. It is drought tolerant and cultivated in Punjab, Madhya Pradesh, Karnataka, Tamil Nadu, Gujarat, West Bengal and Himachal Pradesh. It is used for suji preparation.

3. **Common bread wheat (*Triticum vulgare*)** - It is a typical wheat of alluvial soils of Indo Gangetic plains *i.e.*, Punjab, Uttar Pradesh, Bihar and parts of Rajasthan. Bulk of Indian crop consists of this type.
4. **Indian dwarf wheat (*Triticum spherococcum*)** - This is found in limited areas of Madhya Pradesh, Uttar Pradesh of India and in Pakistan. They are characterized by very short and compact heads having shorter grains. This belongs to the club wheat of western countries.
5. **Bread Wheat (*Triticum aestivum*)** - This is the type presently grown in India in almost all the wheat-growing zones. It is introduced in India by Dr. N.E. Borlaug of Mexico and called as Mexican dwarf wheat. It is the bread wheat.

D. Growth Stages

1. Pre establishment stage:

- (a) **Pre-emergence:** Sprouting of seeds by giving rise to seminal roots and coleoptiles.
- (b) **Emergence:** Appearance of coleoptiles from germinating seeds above the soil surface.

2. Vegetative stage:

- (a) **Seedling:** The young plants establish larger root systems in this stage. The stage may be further differentiated as one leaf, two leaf, three leaf and four leaf stages.
- (b) **Crown root stage:** This coincides with three or four leaf stage in which the crown roots appear.
- (c) **Tillering:** Plants develop crown and branch out into tillers from their base at soil surface.
- (d) **Jointing:** This is the stage at which the plants start elongating when the nodes start developing above the crown node.

3. Reproductive stage:

- (a) **Booting:** In this stage, the uppermost leaf swells out into flag holding the spike into it.
- (b) **Heading:** The spikes start emerging out from the leaf sheath at this stage.
- (c) **Flowering:** Anthesis of florets and fertilization of ovaries takes place at this stage.

4. Post anthesis stage:

- (a) **Fillling:** The ovaries after fertilization start elongating into seeds and pass through milk, soft dough and hard dough stages.
- (b) **Maturity:** Colour of the glumes changes and kernels become fairly hard at this stage.

E. Important Varieties

Sonora 64 is dwarf variety introduced to India from Mexico. It is early ripening, resistant to lodging, grown well in late crop rotation with sugarcane or sweet potato. Its grain contains 12.4–14.4% protein. When irrigated, it yields 6–7 t/ha.

Lerma Rojo is a semi dwarf variety, strongly tillering. The period from blossoming until ripening is short. The resistance to rust is high. Sowing time is late. The yields are high (7 t/ha under optimal conditions).

Kalyan Sona is a dwarf variety of Indian selection. Bushy, late ripening, very productive under favourable conditions (up to 8 t/ha).

Sonalika is a short stem, medium bushy, early ripening and high yielding variety (up to 7 t/ha).

F. Soil

Wheat is grown in a variety of soils in India. Well drained loam and clay loams are good for wheat.

However, good crop of wheat is raised in sandy loams and black soils also. Soils should be neutral in reaction. Heavy soils with good drainage are suitable for wheat cultivation under dry condition. In India, wheat growing areas can be divided into 5 soil divisions.

- The Gangetic alluvium of Uttar Pradesh and Bihar,
- The Indus alluvium of the Punjab and Haryana,
- The black soil regions of central and southern India comprising Madhya Pradesh and parts of Maharashtra and Karnataka,
- The hilly regions of the Himalayas and elsewhere, and
- The desert soils of Rajasthan.

G. Climate

Wheat has wide adaptability. It can be grown not only in tropical and sub tropical zones but also in temperate zones and the cold tracts of the far north. It can tolerate severe cold and snow. It can be cultivated from sea level to as high as 3300 m. The optimum temperature range for ideal germination of wheat seed is 20–25°C, though the seed can germinate in the temperature range of 3.5–35°C. It can be grown in regions where rainfall varies from 25–150 cm/year. The wheat plants require medium (50–60%) humidity for their growth. But at the time of maturity, crop requires less humidity and warm season. At the time of maturity, the plants require 14–15°C.

H. Season and Varieties

Zone	Irrigated		Rainfed	
	Timely sown 15–30, November	Late sown up to 25th Dec.	Timely sown up to 15th Nov.	Late sown
Hilly zone	Girija, HB 208, Sonalika, Shailaja	Sonalika, UP 1109	Kalyanasona, HD 2204, Ridley	UP 1109
NW Plain zone	Sonalika, Arjun Jairaj, HD 2204	Sonalika, Swati, HD 2270	Kundan, Pratap, Mukta, Sujata	–
NE Plain zone	HD 2402, Janak	Sonalika, Sonali	Pratap,WL 410	K 8962, HDR 77
Central zone	HD 2381, HD 4530, Jairaj, LOK-1	HD 2327, Sonalika, LOK-1, Swati	Sujata, Meghdoot, Kalyanasona	–
Peninsular zone	HD 2189, DWR 39	HD 2610, DWR 195	Meghdoot, Mukta	–
Southern hills zone	HW 741, HW 972	NP 200	NP 200, HW 517	–
Saline soils	KRL 1–4, Raj 3077	–	–	–

I. Time of Sowing

Temperature during growing season and at grain filling is one of the several factors deciding the sowing time. However, ideal temperature requirement varies from plant type and stages of growth. Wheat plants are very sensitive to very cold and frost injury at any stage of growth particularly at reproductive stage if temperature is below 15°C. The dwarf varieties require the following temperature for their growth and development.

<i>Growth stages</i>	<i>Temperature requirement</i>
Germination	20–25°C
Tillering	16–20°C
Accelerated growth	20–23°C
Proper grain filling	23–25°C

The sowing dates for wheat varieties is given below. Under unavoidable circumstances sowing may be delayed up to first fortnight of December beyond which it is not advisable.

Indigenous wheat	: Last week of October
Long duration dwarf wheat like Kalyan sona, Arjun etc.	: 1st fortnight of November
Short duration dwarf wheats like Sonalika, Raj 821 etc.	: 2nd fortnight of November
Late sown condition	: 1st week of December

J. Systems of Wheat culture

1. Irrigated wheat 2. Rainfed wheat

I. Irrigated wheat

Land preparation: In general, wheat requires a well-pulverized, but compact seedbed for good and uniform germination. In irrigated areas, wheat is sown after kharif crops, hence the field is ploughed with disc or mould board plough followed by 2–3 harrowing and 2–3 planking should be given. One pre sowing irrigation 7–10 days before seeding is necessary to ensure good germination.

Seed rate-	Normal sowing	: 100 kg/ha
	Bold seed/late sown condition	: 125 kg/ha

Seed treatment: Treat the seeds with any one of the fungicides like captan or thiram at 2 g/kg of seeds 24 hours before sowing.

Spacing:	For normal sown crop	: 20–22.5 cm between the rows
	For delayed sowing	: 15–18 cm.

Depth of sowing: Since the coleoptiles length is 5 cm, depth of sowing should not more than 5 cm and the optimum depth of sowing is 2.5–5.0 cm.

Method of sowing

- (a) **Broadcast sowing:** Seeds are broadcasted and then worked in by harrowing to cover the seeds. In this method, germination is very poor and plant stand is often irregular, since the seeds are not placed in the moist zone.
- (b) **Sowing behind the country plough:** A majority of farmers use this method. The seed is dropped in furrows by hand and it is called as 'Kera method' and when it is dropped through a 'pora', a special set of attachment with local plough, it is called "Pora method". In this method, seeds are dropped at 5–6 cm depth.
- (c) **Drilling:** Seeds are sown by seed drill or fertiseed drill. It ensures uniform depth of sowing, proper placement of fertilizers and good germination.

- (d) **Dibbling:** This method is used in the case where supply of seeds is limited, using the implement is called “Dibbler”. It is not a common method, because it is time consuming.
- (e) **Transplanting:** It is not a common practice. When the sowing delays beyond 1st week of December, seedlings are raised in the nursery and transplanted on 25 DAS at 2–3 seedling/hill at a spacing of 15 cm × 5–7.5 cm. The varieties Kalyansona and Sonalika are best for transplanting.

Manures and Fertilizer: Application of FYM or compost at 12.5 t/ha at the time of last ploughing is recommended. Fertilizer application should be made based on the soil test recommendation. If it is not done, blanket recommendation may be followed as given below:

Condition	Recommended dose (kg/ha) $N : P_2O_5 : K_2O$	Time and method of application
Timely sown	120:40:40	50% N and 100% P and K drilled at 5 cm and the remaining 50% ‘N’ at first irrigation.
Late sown	80:40:40	50% N and 100% P and K drilled at 5 cm below the seed and the remaining 50% ‘N’ at first irrigation.
Irrigated if followed	80:40:40	50% N and 100% P and K drilled at 5 cm below the by legume crop seed and the remaining 50% ‘N’ at first irrigation.

In light soil, ‘N’ should be applied in 3 equal splits *viz.*, 1/3 as basal, 1/3 at 1st irrigation and 1/3 at 2nd irrigation.

Weed Management: The critical weed free period is up to 30 DAS. Post emergence application of Isoproturon (Tolkan 50% WP or Arelon 50% WP) on 30–35 DAS at 1.0 kg a.i./ha followed by one hand weeding or combined application of Isoproturon at 0.75 kg a.i./ha + 2,4-D at 0.5 kg a.i./ha on 30–35 DAS is more effective for the control of monocot and dicot weeds or pre emergence application of pendimethalin at 1.0 kg a.i./ha followed by one hand weeding on 30–35 DAS is more efficient and economical method.

Water Management: Wheat requires 440–460 mm of water. Irrigation at 50% available soil moisture or 50% depletion of available soil moisture is optimum. The critical stages of crop for irrigation

1. Crown root initiation-CRI	(21–25 days)
2. Tillering	(45–60 days)
3. Jointing	(60–70 days)
4. Flowering	(90–95 days)
5. Milky stage	(100–108 days)
6. Dough stage	(120–125 days)

Of these, irrigation at CRI stage is the most important and delay of every day results in reduction of 1.4% grain yield/day. It has also been noticed that if any of following irrigation is delayed or missed, the yield is reduced to the extent of 5-10 kg/ha.

Number of irrigation

<i>One CRI</i>	<i>Two CRI</i>	<i>Three CRI</i>	<i>Four CRI</i>	<i>Five CRI</i>
	Boot leaf Boot leaf Milky stage Milky stage	Tillering Boot leaf Flowering	Tillering Jointing	Tillering

Cropping system: The following cropping systems are being followed in northern India.

Wheat + sugarcane (4–5: 1), Wheat + pea (4:2), Wheat + gram (1:1), Wheat + chick pea (4:2), Wheat + lentil (4:2), Wheat + mustard (8:2) , Wheat + linseed (4:2).

Wheat may be grown as relay crop in potato after earthing up especially in case of early crop of potato.

Harvesting and threshing: Harvest when the leaves and stems turn yellow and becomes fairly dry. Harvest when there is about 20–25% moisture content. Harvesting is done by using sickle or bullock driven reapers or by using combine harvester. After threshing and cleaning, the grain is dried in the sun for 3–4 days for getting 10–12% moisture for storing. The best time for harvest in hilly zone is May to June, North-western plain zone- Mid April, North-eastern plains zone—March to April, Central zone—February to March and Peninsular zone—February.

Yield: The yield varies from 4.5–5.5 t/ha.

Post Harvest Technology: Wheat is usually ground into flour before used as food. Earlier days stone grinding was done. Now-a-days steel roller mills are available for grinding.

Process of milling: Before milling, wheat is tempered by adding water about 24–48 hours earlier to milling so that the moisture of grains comes around 14%. This allows better separation of bran from the endosperm. Wheat is eaten as atta in the north and west, in the south and east as maida and suji. Rava is consumed mainly in the south. Pasta is a mixture of flour and salt. Pasta products comprise vermicelli, noodles, macaroni and spaghetti.

Storage: If the moisture content of grain is more than 12%, they are eaten up by storage pests. There is marked deterioration in weight, taste, nutrients or nutritive value and germination of wheat grains when they are stored. Safe storage means ensuring that the stored grains retain their original weight, taste, nutritive value and germination.

3. MAIZE (*Zea mays*.L)

Maize is one of the important cereal crops in the world's agricultural economy both as food for men and feed for animals. Because of its higher yield potential compared to other cereals, it is called as "Queen of Cereals". Several food dishes *viz.*, chapatti are prepared from maize flour. Green cobs are roasted and eaten by the people. Popcorn is used for popped form; green cob for table purpose. Corn has low fibre content, more carbohydrate and most palatable. It is widely used in preparation of cattle feed and poultry feed. It can be used as green fodder and has no HCN content. It can be preserved as silage. Food products like corn meal, corn flakes etc., can be prepared. It is used in making industrial products like alcohol, corn starch (dextrose), glucose, corn oil, corn syrup etc., and used in canning industry, production of polymer, making paper, paper boards, bread etc., Maize grain contains proteins (10%), carbohydrates (70%), oil (4%), albuminoides (10.4%), crude fibre (2.3%) and ash (1.4%). Maize grain has significant

quantity of vitamin A, nicotinic acid, riboflavin and vitamin E. Maize is low in calcium, but fairly high in 'P. Maize protein 'Zein' is deficient in two essential amino acids viz., Lysine and 'Tryptophane'.

A. Classification

Classification is largely based on the character of the kernels. It is classified into seven groups (Kipps, 1959).

1. **Flint corn (*Zea mays indurata*):** Starchy endosperm enclosed with hard hammy endosperm. Kernel size is large with flat bottom and round at the top. High proportion of starch. Colour may be white or yellow. This is the type mostly grown in India.
2. **Dent corn (*Z. mays indentata*):** Because of formation of dent on the top of kernel having white or yellow, it is called as dent corn. Maize kernels have both soft and hard starches. The hard starch extends on the sides and the soft starch is in the centre and extends to the top of the kernel. Depression or dent in the crown on the seed is the result of drying and shrinkage of soft starch. This type is widely grown in USA.
3. **Pop corn (*Z. mays averta*):** Kernel size is small. Hard and corneous endosperm is present.
4. **Sweet corn (*Z. mays saccharata*):** The sugar and starch make the major component of the endosperm that results in sweet taste of kernels. It is mainly grown in Northern half of USA. The cobs are picked up green for canning and table purpose.
5. **Flour corn (*Z. mays amylaceae*):** It resembles to the flint corn in appearance and ear characteristics. The grains are composed of soft starch and have little or no dent (called as "soft corn"). It is widely grown in USA and South Africa.
6. **Pod corn (*Z. mays tunicata*):** Each kernel is enclosed in a pod or husk in an ear, which enclosed in husks, like other types of corn.
7. **Waxy corn (*Z. mays cerabina*)-** The kernel looks to have waxy appearance and gummy starch in them, because of amylopectin. Starch is similar to that of tapioca starch for making adhesive.

B. Origin

Mexico and Central America.

C. Area and Production

It is cultivated in an area of 130 m.ha with a production of 580 m.t. It is grown in USA, China, Brazil, Mexico and India. USA ranks first in area, production and productivity (6865 kg/ha). India occupies 5th place in area and 11th place in production. In India, it is cultivated in area of 6.25 m.ha with a production of 10.61 m.t. Average productivity is 1698 kg/ha. In India, it is cultivated in Uttar Pradesh, Rajasthan, Madhya Pradesh, Karnataka and Bihar. The production level is in the order of Uttar Pradesh > Bihar > Karnataka. Karnataka recorded the highest average yield of 3379 kg/ha.

In Tamil Nadu, it is cultivated in an area of 81,800 ha with a production of 1,32,900 t and productivity of 1625 kg/ha. It is mainly cultivated in Coimbatore, Erode, Salem, Madurai, Trichy, Thanjavur and Pudukottai districts. It is cultivated in southern districts, Dindugul and Perambalur districts under rainfed condition.

D. Climate

It is essentially a tropical crop. It is a C4 short day plant. Though it is a tropical crop, it has got high adaptability to wider climate (55°N–45°S). It can be grown up to 2500 m above MSL. This crop is not suitable when night temperature drops below 15.6°C. Maize requires moist and warm weather from germination to flowering. Most suitable temperature for germination is 21°C and for growth is 32°C.

Extremely high temperature and low RH at flowering desiccate the pollen resulting in poor pollen grain formation. Temperature more than 35°C reduces the pollen germination. Temperature < 15°C delays silking and tasseling. Rainfall of 500–750 mm of well distributed rain is required for growth.

E. Soil

Maize is best adapted to well-drained sandy loam to silty loam soil. Water stagnation is extremely harmful to the crop, therefore proper drainage is must. Maize cannot thrive on heavy soils especially on low lands. pH ranges from 5.5–7.5. The alluvial soils of Uttar Pradesh, Bihar and Punjab are very suitable for growing maize crop. Salinity and water logging are harmful at seeding stage. Continuous water logging for 3 days reduce the yield by 40–45%.

F. Growth Stages

- Seedling stage : 1–14 days (from sprouting to 2–4 leaves)
- Vegetative phase : 15–39 days (30–35 days is knee high stage)
- Flowering phase : 40–65 days
- Maturity stage : 66–95 days (including soft and hard dough stage)
- Ripening : 96–105 days

G. Varieties

Hybrids: The duration of hybrids is 100-105 days. Some of the important hybrids are Deccan, Ganga Safed, Ganga-2, Ganga-4, Ganga-5, Ganga-7,9, Histarch and Sangam, In Tamil Nadu, CoH1, CoH2 and CoH3 Hybrids are also cultivated (5.5–6.0 t/ha).

Promising Composites: The duration of composites is 100-105 days. *E.g.*, Amber, Vijay, Kisan, Sona, Vikram, Jawahar (5.0–5.5 t/ha). Short duration composites are K1(80–85 days) and Co1 (105 days).

H. Cropping System

Some of the important cropping systems in India are maize-potato, maize-berseem, maize-chickpea/safflower (rainfed) and maize-potato-wheat. Tamil Nadu, the maize is cultivated with green gram, onion and cotton in cropping system. The important rainfed intercropping are maize + green gram, maize + groundnut, maize + soybean, maize + cowpea and maize + red gram. In North India, short duration maize varieties like Kathri and Sathi (65–75 days) is grown as intercrop in sugarcane in Uttar Pradesh.

I. Time of Sowing

In India, it is grown in 3 seasons. Yield of maize is more during rabi and spring season. It is cultivated in 85% of rainfed area during kharif (June–July). During rabi, it is cultivated in peninsular India and Bihar and during spring season, it is cultivated in north India under irrigated condition. In Tamil Nadu, it is cultivated in winter/rabi (end of December-1st week of January (Thaipattam)), Kharif (first fortnight of June or first fortnight of August (Adipattam) and rainfed condition (end of September-October 1st week (Purattasi pattam)).

J. System of Maize Cultivation

I. Irrigated maize

It is cultivated in 22% of the total area under maize cultivation.

Field preparation: The crop does not require fine tilth. Field is ploughed to a depth of 25–30 cm using mould board plough, followed by 3–4 ploughing with desi plough or harrow. In clay soils, the

main problem is the formation of hardpan. Chiseling reduces the hardpan formation and there is increase in yield of 25–30%.

Varieties:

- Co1-Composite, 105–110 days, suited for Coimbatore, Erode, Pudukottai and Thanjavur.
- K1-Composite, 80–85 days, highly tolerant to drought, suited for Pudukottai district.

Hybrids:

- **CoH1** : 90–95 days duration, suited for all locations and highly drought tolerant and resistant to downy mildew.
- **CoH2** : 100–105 days, suited for all locations. It is resistant to downy mildew.
- **CoH3** : 90–95 days
- **CoBC1** : 55–65 days, for dessert and canning, suited for all areas of Tamil Nadu, green fodder yield up to 32 t/ha. (Multiple cobs 2–3, 7 pickings at interval of 2 days).

Land shaping: Formation of ridges and furrow system (at 60 cm interval) is good due to good drainage and less water logging.

Method of sowing: Mostly direct seeding is adopted. Sowing/dibbling behind country plough is also adopted. Transplanting is adopted in problem areas like Dharmapuri and Pudukottai, where red ferruginous and laterite soils exist.

Pai Nursery technique is advocated. Raised bed is formed and above the seedbed, spread compost and S and at 1:1 ratio and dibble the seeds. Cover it; sprinkle the water for 3–4 days. Pull out the seedling on 5th day.

Seed treatment: The seed treatment is done with any fungicide followed by Azospirillum (3 pockets). Seed treatment with 3 pockets of Azospirillum followed by soil application of Azospirillum @10 pockets (2 kg/ha) with FYM at 50 kg/ha can be followed.

Seed rate: The seed rate for composite is 20 kg/ha and for hybrids, it is 15 kg/ha.

Spacing: 60 × 20 cm (83,333 plants/ha). For getting maximum yield of irrigated crop adopt 1.1 lakh plants (60 × 15 cm) with 200:100:80 kg NPK/ha (N and K application in 3 splits) + 25 kg ZnSO₄/ha.

Fertilizer management: Among the cereals, it requires huge amount of fertilizers. If there is no soil test recommendation, a blanket recommendation of NPK at 135:62.5:50 kg/ha is recommended for irrigated maize, besides application of 12.5 t of FYM/ha and 12.5 kg micronutrient mixture. Apply fertilizer 5 cm below the soil and 10 cm away from the root zone. 100% P and K should be applied as basal. ‘N’ should be applied in 3 splits viz., 25% basal, 50% on 25 DAS and 25% on 45 DAS. In all the cereal crops, there is two peak stages of uptake, where as in maize, there are three peak stages of uptake. For transplanted crop, ‘N’ should be applied at 50% basal and 25% each at knee high stage and tasselling stages.

Ist peak	30–35 days	(Knee high stage)
IInd peak	50–60 days	(Tasselling)
IIIrd peak	70–80 days	(dough stage).

ZnSO₄: Zn’ deficiency cause “White bud” in Maize. Apply ZnSO₄ at 25 kg/ha at the time of sowing. If not possible, foliar spray of 0.5% ZnSO₄ at critical stages is recommended.

Water management: It requires 500–600 mm of water. Critical stages for irrigation are tasselling

and silking. Peak consumption of water also occurs during this period (taselling and silking). In Clay/clay loam soils, totally 8 irrigations are required. For light soils, two more irrigations are needed.

- Germination phase** : Two irrigations 1st after sowing, 2nd as life irrigation 4th day)
- Vegetative phase** : Three irrigations at 12th day, 25th day and 36th DAS.
- Flowering phase** : Two irrigation on 48th and 60th day
- Maturity phase** : 1 irrigation on 72nd day

Weed management: The crop—weed competition is upto 45 days. Application of pre emergence herbicides like Simazine and Atrazine at 0.25 kg/ha, followed by one hand hoeing and weeding on 30–35 DAS is recommended. For intercropping systems, atrazine should not be used. For maize + pulse intercropping system, pre-emergence application of pendimethalin 1.0 kg a.i./ha followed by one hand weeding on 30–35 DAS is recommended. Spraying should be done within 3 days. There should be adequate soil moisture. The soil should not disturbed immediately after application. It is better to use high volume sprayer fitted with deflected type or flat fan nozzle. If pre-emergence herbicide is not applied, post emergence application of 2,4 D Na salt (Fernoxone 80 WP) at 1.0 kg a.i./ha on 2 or 3rd leaf stage for sole crop of maize is recommended. For maize + soybean/pulse intercropping system, pre-emergence application of alachlor at 2.0 kg a.i./ha (Lasso 50% EC), followed by one hand weeding is recommended.

Thinning and gap filling: Thinning is done by keeping one healthy seeding/hill on 7–8 DAS. Gap filling is done where seedlings are not germinated (dibble 2 seeds/hill) and immediately pot water it. The crop should be earthed up after application fertilizer at 30–35 DAS to prevent lodging.

Harvesting and grain shelling: The grain cob is harvested, when cob sheath turns brownish and grains become hard. They do not contains more than 20% moisture and they are piled up for 24 hours and then dried in the sun for 5–6 days to reduce the moisture to 10–12%. The green stalks are harvested separately and used as fodder.

Shelling: Hand shelling is a common practice, but efficiency is very poor. Now, corn sheller of greater efficiency, which is manually driven, tractor drawn, electricity operated is available. The left over plants are used as green fodder or straw.

15.2 MINOR CEREALS

1. BARLEY (*Hordeum vulgare* L. emend, Lam .)

Barley is a rabi cereal crop. It is the major source of food for large number of peoples in cooler semiarid parts of the world. It is the staple food in Tibet, Nepal and Bhutan. In European countries, it is used only as break fast food. Barley contains protein (11.5%), carbohydrates (74%), fat (1.3%), crude fibre (3.9%) and ash (1.5%). Flour is used for making ‘Chapatti’ along with wheat flour or gram flour and used as “Missi rotti”. It is used for preparation of malt, beer, whisky and industrial alcohol, vinegar and it is also used in malt and brewing industries and biscuit making. Grain is broken and roughly ground into pearl barley to be used in soup. Excess grain is used as cattle feed and horse feed.

Origin: Abyssinia as the centre of origin for hulled, awned type and South-East Asia particularly, China, Tibet and Nepal as centre of origin for hullless six rowed varieties.

Classification: Cultivated barley varieties are classified based on number of rows of grain and their arrangement. Of these, six rowed barley is the most commonly cultivated type.

1. Six rowed barley : *Hordeum vulgare*
2. Two rowed barley : *Hordeum distichum*
3. Irregular barley : *Hordeum irregular*

Area and distribution: It is grown in many countries *viz.*, Russia, Canada, Germany, France, China, USA, Turkey, India, Australia, Spain etc. Former USSR ranks first in acreage and production. It is cultivated in area of 76.2 m.ha. with a production of 171.9 m.t. and productivity of 2.26 t/ha. In India, it is cultivated in area of 8.84 l.ha. with a production of 16.54 l.t. and productivity of 1.87 t/ha. Of the total area, 61.0% area is under irrigated condition and 39% is under rain fed condition. In India, it is cultivated in Uttar Pradesh (50% of the area), Rajasthan (20% of the area), Madhya Pradesh, Punjab and Haryana. In Tamil Nadu, it is grown in a smaller area in Nilgris and Palani hills.

Climate: Climatic requirement is similar to Wheat. It is an important food crop in higher altitude. In very high altitude of 2000 m above MSL, it is grown only as summer crop. It comes up well in cool climate. Warm and moist conditions are not conducive. It requires around 12–15°C during growing period and around 30°C during maturity. It cannot tolerate frost. Frost and hailstorms at flowering are detrimental. Rain at ripening phase causes discolouration of grain and it is not good for malting or seeding. The crop possesses high degree of tolerance to drought and sodic condition.

Soil: Sandy to moderately heavy loam soil of Indo-gangetic plains having neutral to saline in reaction and medium fertility are most suited for barley. Being a salt tolerant crop, it is the best substitute for sodic soils and also for saline coastal soils in West Bengal and black soils of Karnataka. A higher spot with efficient drainage would be best location for barley. The soil should not be very fertile which causes lodging and reduce the yield. Acidic soils are not suitable.

Season: The season is given below:

Rainfed crop	: Before end of October or 1st week of November
Irrigated	: 1st or 2nd week of November
Late sown	: Up to December
Hilly zones (2000 m)	: 1st week of November

Seed rate: The seed rate for irrigated crop is 75–100 kg/ha and it is 80–100 kg/ha for rainfed crop and 100 kg/ha for crops raised in saline soil.

Spacing: The spacing for irrigated crop is 23 cm row spacing and for rainfed crop, row spacing of 23–25 cm is followed. The depth of sowing for irrigated crops is 5 cm and for rainfed crop, it is 6–8 cm depth.

Varieties: There are two type of varieties *viz.*, (i) Huskless and (ii) Hulled barley.

I. Suited for Hilly Areas (Northern hills)

Himami: Developed at Simla, medium to lower hills, 140–145 days, 3.2–3.6 t/ha.

Dolma: Medium to high elevation, 140–150 days, resistant to yellow rust, 3.5–4.0 t/ha.

Kailash: Six-row hulled variety, medium to lower elevation, 145–150 days, resistant to yellow rust, 4.0 t/ha.

II. Rainfed Areas

Ratna: Developed at IARI, six rowed hulled variety, 125–130 days, 2.5–3.0 t/ha—It is grown in Uttar Pradesh, West Bengal, Bihar.

Vijay: Developed at Kanpur, 120–125 days, 3.0–3.5 t/ha, suited for cultivation in Uttar Pradesh, Delhi, Madhya Pradesh, Punjab.

Azad: Developed at Kanpur, resistant to yellow rust, 115–120 days, 3.5–3.8 t/ha.

Ameru: Developed from Kanpur, 130–133 days, 2.5–3.0 t/ha, best for production of Malt and for brewing.

III. Irrigated Areas

Jyoti: Six rowed hulled variety, developed from Kanpur, 120–125 days, 3.5 t/ha.

Ranjit: Six rowed, semi dwarf, non-lodging, 125–130 days, 3.0–3.5 t/ha, recommended for commercial cultivation.

Clipper: Two row barley variety, 135–140 days, 28–30 q/ha, best for malt production and brewing purpose.

Karan 18 and 19: 5.0–5.6 t/ha.

IV. Dual Purpose Varieties (Fodder and Grain)

Ratna, Karan 2, Karan 5 and Karan 10.

Land preparation: Barley being a shallow rooted crop, responds well to light textured, fine seed-bed. One ploughing with soil turning plough followed by 2–3 ploughing with desi plough or 2–3 harrowing by tractor or bullock power is done. In areas where termite is a problem, mixing the soil with BHC 10% at 20–25 kg/ha or aldrin 5% dust at 10–15 kg/ha is recommended.

Seed treatment: The seeds are treated with either Captan/Thiram/Bavistin @ 2 g/kg of seeds. In the case of saline and rainfed areas, sowing of overnight soaked seeds is recommended for quick germination and also ensures better stand.

Nutrient management: Application of FYM at 12.5 t/ha during last ploughing is recommended. The fertilizer schedule for different conditions is given below:

Condition	Recommended		
	N:	P ₂ O ₅ :	K ₂ O
Irrigated crop	60:	30:	20
Malt production	30:	20:	20
Rainfed crop	40:	20:	20

Application of 50% N and 100% P and K as basal and the remaining 50% N at 30 DAS (1st irrigation) is recommended. In rainfed and saline soils, entire fertilizer should be drilled below 8–10 cm depth as basal. In light textured soil, N should be applied in three splits *viz.*, 50% as basal, 25% during first irrigation, 25% during second irrigation.

Method of sowing: The method of sowing is similar to wheat *i.e.*, either by broadcasting or Pora and Kera method.

Water management: It requires 200–250 mm water. 2–3 irrigations are adequate. Light soil requires 4 irrigations. The critical growth stages are 1. seedling or sprouting stage, 2. active tillering stage (30–35 DAS), 3. flag leaf and 4. milling stage or soft dough stage. Of these, active tillering stage around 30–35 DAS and grain filling (60–65 DAS) are most critical.

Weed management: The critical period is upto 30 days. Post emergence application of Isoproturan 0.75 kg/ha + 0.5 kg/ha of 2,4-D combination followed by one hand weeding on 35–40 DAS (3–5 leaf stage) is recommended for effective control both dicot and monocot weeds. Application of Pendimethalin (pre-emergence) 1.0 kg/ha, followed by one hand weeding is also recommended.

Barley based cropping system: Barley is grown mixed with crops like chickpea, mustard, pea, linseed and lentil. Barley being a short duration crop is more suitable for rotation than wheat. The following are the common rotations.

Paddy - barley	Cotton - barley
Jowar - barley	Maize - barley
Bajra - barley	Urdbean - barley

Harvest: Harvesting is similar to that of wheat. Timely harvest ensures quality grain and prevents different losses. Threshing is done either by using animal or mechanical threshers. Then winnowing and cleaning is done. Storage of grains at 10–12% moisture level is good. The yield is 3.0–3.5 t/ha (grain) and 4.0–5.0 t/ha (straw).

2. OATS (*Avena sativa*)

It is one of the most important rabi/winter cereal fodder crops of India. It is used as green fodder, straw, hay or silage. Oat grains make a good balanced concentrate in the rations for poultry, cattle, sheep and horse. Green fodder contains about 10–12% protein and 30–35% dry matter. It is fed to animals mixed with berseem or lucerne green fodder. Its fodder and grains are highly nutritious and preferred by milch cattle and draft animals. Very small portion of oat grain is processed into food in the form of “rolled oats and oat meal” for human consumption.

Origin: Perhaps originated in Asia Minor.

Area: The leading oat producing countries are former USSR, USA, Canada, Poland, China, France and Australia. It is cultivated in an area of 26.8 m.ha. with a production of 40.3 m.t. In India, it is cultivated on large scale in Punjab, Haryana, Uttar Pradesh and a limited area in certain part of Himachal Pradesh, Maharashtra, Madhya Pradesh, Orissa, Bihar and West Bengal. In Tamil Nadu, it is grown in Nilgris.

Classification: According to their chromosome number, the oats are grouped into three groups.

Group I: *A. brevis*: Short oats are grown in Southern Europe for green fodder and hay.

Group II: *A. abyssinica*: “Abyssinian oat” is grown in several parts of North Africa for fodder.

Group III: *A. sativa*: “Common Oat”. It occupies 80% of total acreage under oat.

A. byzantina: “Red oat” is grown around Mediterranean region, Europe and North Asia and warmer sub tropical area for both grains and fodder. It is also cultivated in India, next to *A. sativa*. It is a heat tolerant crop.

A. chirensis: Chinese naked oat extensively is grown in hilly parts of China for grain.

A. strigosa: Called “sand oat”.

Dual purpose (Grain and fodder): Grown in Mediterranean region. Of this, 80% of area is under *A. sativa* and the remaining area is under by *A. byzantina*.

Climate: It requires cool temperature during germination, tillering, booting and heading stages. High temperature at blooming increases empty spikelets and reduces the seed yield. Oat requires about 15–25° C for its optimum growth. Oat requires more moisture to produce a given unit of dry matter than any other cereal except rice. Rainfall should not exceed 760 mm and should be well distributed.

Soil: It can be grown on all types of soils except the alkaline water logged soils. Oats generally make their best growth on loamy soils, but produce satisfactory yield on heavy or light soil.

Varieties:

Kent: Introduced from Australia, mid late variety, resistant to blight, rust and lodging, dual purpose, fodder yield of 60–65 t/ha, grain yield of 3–3.5 t/ha.

Algerian: For irrigated areas, slow growing, 145–150 days duration, green fodder yield of 40–45 t/ha.

Bunker 10: Mid season variety, suitable for moisture shortage condition, resistant to loose smut, green fodder yield of 40 t/ha.

Coachman: Introduced from USA, erect habit, green fodder yield of 50 t/ha.

HFO 114: Erect type, multicut variety, green fodder yield of 50–55 t/ha, grain yield of 2.5 t/ha, suitable for Haryana.

UPO 50: Medium late and semi erect variety released from Pantnagar, resistant to rust, blight and lodging, fodder yield of 45–50 t/ha, suitable for cultivation in Uttar Pradesh.

This crop is rotated with other crops. 1. Jowar–Oat–Maize, 2. Maize–Oat–Maize, 3. Cowpea–Oat + Mustard–Maize + Cowpea, 4. Jowar + Cowpea–Oat + Lucerne.

Time of sowing: Optimum time of sowing is from middle of October to middle of November. Middle of October for fodder production and middle of November for seed production is recommended.

Seed rate: The seed rate is 100 kg/ha. Drill sowing is better than broadcasting.

Field preparation: The field should be thoroughly prepared to get a fine and firm seedbed, for which one deep ploughing followed by 3–4 harrowings and plankings are done. Long narrow beds may be laid out across the field so that only single irrigation channel along the upper side of the field may serve the purpose.

Spacing: The spacing is 20–23 cm for fodder and 23–25 cm for grain.

Manuring: Application of organic manures like FYM or compost at 15.0–20.0 t/ha is recommended. Application of NPK at 80:40:0 kg/ha is done. Apply entire 'P' as basal and 'N' should be applied in three splits viz., 60 kg N/ha as basal, 10 kg N/ha at 1st irrigation (25–30 DAS) and 10 kg N/ha after 1st cutting.

Water management: It requires high amount of water and it is irrigated once in 20–25 days and 4–5 irrigations are needed. Generally irrigation is necessary after each cutting. Critical stage is tillering stage.

Weed control: Usually one weeding after 3–4 weeks of sowing is enough.

Harvesting: The crop needs about 120–150 days to mature. It is common practice to take 2 or 3 cuttings of fodder and then to allow the crop to grow for seed. But normally, only two cuttings are taken from the seed or grain crop. Of these two cuttings, first is taken after 60–65 days and second after 90 days of sowing or at the flowering stage of the crop. Then, plants are allowed to grow and set seeds.

Yield: If it has given two cuts, green fodder yield is 50–60 t/ha and grain yield is 200–400 kg/ha. If the crop is allowed after 1st cut for seed set, the fodder yield is 25–30 t/ha with seed yield of 3–3.5 t/ha. The straw yield is 2.5–3 t/ha. Threshing, winnowing and cleaning of the grain will be followed as done for wheat.

3. RYE (*Secale cereale*)

It is a minor rabi cereal. It is mainly used as green fodder crop, pasture crop, green manure crop and cover crop. The flour of rye is mixed with wheat flour for making bread. The straw is used for bedding and packing material.

Origin: Western Asia and Southern former USSR.

Area and distribution: In the world, it is cultivated in an area of 16.3 m.ha. with a productivity of 40.7 m.t. About 60% of area is in former USSR, followed by Germany, Austria, Hungary, USA, Canada, Poland, Turkey etc. In India, it is grown in Punjab, Haryana and Uttar Pradesh.

Climate: It can withstand all adverse weather conditions except heat. It is commonly called as “winter hardy cereal”.

Soil: It is the only one rabi cereal best suited for sandy soil.

Season: The best seasons are winter and spring seasons.

Varieties: For winter season, the varieties like Athens and Abruzzes for Forage type, the varieties like Rosen, Dakold and Balba for grain type are recommended. For spring season, the varieties like Prolific and Merced are recommended for grain type.

Time of sowing: The time of sowing is October for forage crop, November for grain crop and August for pasture or green manure or cover crop.

Seed rate: The seed rate is 75–95 kg/ha for forage and 55–65 kg/ha for grain crop.

Land preparation: Summer ploughing is recommended. Stubble mulching is recommended to overcome the erosion. Method of sowing is either by broadcasting or drill sowing. Depth of the sowing is 2.5 cm. Row spacing is 20–25 cm.

Fertilizers: It responds to 30–90 kg N, 35–55 kg P₂O₅ and 65 kg K₂O. 'N' is applied in two splits. Application of BHC 10% or Aldrin 5% at 15–20 kg/ha for termite control is recommended.

Water management: Irrigations are recommended for six stages viz., sowing irrigation, 20–25 DAS (CRI), 40–45 DAS (Tillering), 70–75 DAS (late jointing stage), flowering stage and dough stage (115th day). CRI and heading are the critical stages. If only one irrigation is available, irrigation at CRI is to be done. If two irrigations are available, irrigation at CRI and flowering stages are to be given. If 3 irrigations are available, irrigations at CRI, Late jointing and flowering stages are to be given.

Harvest: For forage crops, two harvests at 50–55th day and at dough stage are done. For forage cum grain crop, harvesting at 50–55th day is done and then it is allowed for seed set.

Yield: If it is for fodder purpose, the fodder yield is 50–55 t/ha. If it is for dual crop, the yield will be 25–t/ha fodder, 2.5 t/ha grain and 2.5 t/ha straw.

4. TRITICALE

Rye, a member of the Poaceae family, is popularly grown as fodder in foreign countries and the same is found on the North Indian hills. It has characteristic feature of growing very profuse with exceptionally more number of tillers per plant under poor fertility status of soil having marginal or no irrigation facilities. Breeders took rye for crossing with wheat and the resultant offspring was named as man made cereal or rye wheat scientifically known as triticale. This was done with a view to reduce the required input in wheat production and to increase the unit area. Besides these, triticale has about 20% protein and a very high biological value, but the greatest drawback is that the grain colour is dark-red, seeds are very wrinkled with low viability and the plants have a very high degree of sterility. The grains are also susceptible to store grain pests. In the present day breeding, these points are being taken into active consideration and probably in near future the farmers would be having a good number of triticale varieties for the cultivation.

15.3 MILLETS

1. JOWAR OR SORGHUM (*Sorghum bicolor*)

It belongs to family Poaceae and genus sorghum. Sorghum is one of the major food crops of the world, particularly Africa and Asia. In India, it ranks third in major food crop, especially central and peninsular India. It is used in various forms, similar to rice as cooked food, malted, flour for dosai and making chapatti or rotli, popped, semolina etc. It is a very good dry and green fodder and a good concentrate feed for cattle and poultry. Raw material is used for starch Industries. It is used in production of alcohol similar to corn and used for preparation of sorghum syrup (20–25% sugar) from sweet sorghum varieties. It is also used for production of Jaggery. It contains high amount of aconitic acid, which prevents the crystallization of sugar. It contains 72.6% carbohydrate, 10–12% protein, 3% fat, 1.6% mineral and

contains more of fibre. It has the capacity to withstand drought or excess moisture (92% of sorghum is grown under rainfed). It comes up well even in marginal soil under moisture stress. It does well in low rainfall areas. It makes comparatively quick growth than maize. It is dormant during stress condition and it resumes its growth, when optimum condition occurs.

Undesirable qualities: It contains high amount of Niacin, which interface with the synthesis of Tryptophane, which is the precursor for synthesis of IAA. “*Pellagaria*” is nutritional disorder due to presence of high amount of Leucine: iso-leucine ratio (3.4). When it is reduced, yield is also reduced. This disease is common in Africa. It contains considerable amount of oxalic acid, which interface with absorption of Ca and metabolism of Ca. Phytin ‘P’ is not utilized due to high oxalic acid. Oxalic acid also affects the Fe uptake. Low digestibility and low palatability is due to presence of phenolic compounds and glycosides, tannin and lignin. Sorghum contains “cynogenic glucoside” called ‘Dhurin’. This glucoside is converted into HCN in the stomach of ruminants. It causes bloating and reduce the transfer of O₂ to the blood steam and causes death of the animal. It is called “*sorghum poisoning*”/(*sorghum effect*). HCN content is more than 100 ppm in the early stage. Critical level is 50 ppm. It (50 ppm) normally occurs during 60-65 DAS or at heading stage. If it is harvested earlier, it should be dried and fed to cattle. “*Sorghum injury*”—Sorghum stubbles/roots have high C:N ratio (50:1), *i.e.*, it contains low amount of ‘N’. Hence, microbes take the soil ‘N’ for decomposition than from the decomposed stubble, which causes temporary immobilization of soil ‘N’. Hence, succeeding crop after sorghum is affected due to N deficiency in the early stage called sorghum injury. Succeeding crops need higher N.

Origin: Warth (1937): Africa and Decandolle (1984): Abyssinia.

Classification: Harlen and De-Wet (1971), gave a modified and simple classification based on spikelet type.

(a) **Basic races:** 1. Bicolor, 2. Guinea, 3. Caudatum, 4. Kafir, 5. Durra.

Now cultivated sorghum is *Sorghum bicolor*.

(b) **Hybrid races:** *Guinea bicolor*, *Caudatum bicolor* etc.

Climate: It is a short day C4 plant. Long day condition delays flowering and maturity. It is a warm weather plant and is grown even in 1500 m from MSL. It can tolerate high temperature throughout their life cycle, better than any other cereal. It is highly resistant to desiccation. It can tolerate water logging. Low temperature at flowering affects the seed set. Rainfall at maturity affects the quality of grain. Low temperature with cloudy weather at flowering induces sugary disease.

Soil: It is grown under variety of soil. Soil with clay loam or loamy texture having good water retention is best suited. It does not thrive in sandy soils, but does better in heavier soils. It does well in pH range of 6.0–8.5 as it tolerates considerable salinity and alkalinity. The black cotton soils of Central India are very good for its cultivation. In Tamil Nadu, 60% of soil is alfisol, where sorghum is grown.

Area, Production and Productivity: The World production is 147 m.t. and it is cultivated in USA, Brazil, Argentina, China and India. In India, it is staple food crop of north Karnataka, Maharashtra, Andhra Pradesh, Gujarat, Madhya Pradesh and Rajasthan. In India, it is cultivated in an area of 11.5 m.ha. with a production of 11.08 m.t. and a productivity of 950 kg/ha. In India, 92.0% of the area is under rainfed. It is mainly grown as kharif crop and smaller extent as rabi crop in Maharashtra, Karnataka, Andhra Pradesh and Madhya Pradesh. In Maharashtra, Karnataka, Madhya Pradesh and Andhra Pradesh, sorghum is grown in both kharif and rabi. The area under cultivation is high in Maharashtra followed by Karnataka, Madhya Pradesh and Andhra Pradesh. At present, Maharashtra has the largest area accounting 43% of Indian area under sorghum and 51% of total production. In Tamil Nadu, it is cultivated in an area of 5.06 lakh ha with a production of 4.86 lakh t and productivity

of 960 kg/ha and it is largely grown in Trichy, Coimbatore, Salem, Dharmapuri, Madurai, Tirunelveli, Vellore and Erode districts. In Tamil Nadu, 85% of area is under rainfed and 15% is irrigated.

I. Rainfed Sorghum

Rainfall: Average and well distributed rainfall of 250–300 mm is optimum for rainfed sorghum.

Distribution: Madurai, Dindugul, Theni, Ramanathapuram, Tirunelveli, Thoothukudi, Virudhunagar, Sivagangai, Trichy, Erode, Salem, Namakkal, Coimbatore and Dharmapuri districts.

Season: There are three seasons.

- **SWM:** Entire north India, it is grown as “Kharif crop” (June-July)—Salem and Dharmapuri in Tamil Nadu.
- **NEM:** All the districts except Salem in Tamil Nadu (September-October to December–January)
- **Rabi:** North India (October) and Dharmapuri in Tamil Nadu.

Field preparation: Field has to be prepared well in advance taking advantage of early showers. FYM @ 12.5 t/ha is applied at last ploughing. Chiselling is recommended to break hardpan once in three years. Depending on the rainfall and soil type, different land shaping methods may be adopted for conservation of the moisture. Black soil having high rainfall areas, formation of broad bed and furrow is recommended. In black soils having low rainfall, form compartmental bunding or sow the seeds in flat bed and form furrows between crops during inter cultivation or during third week after sowing for both the soil types or form dead furrow at 3 m interval.

Varieties: All India Co-ordinated sorghum Improvement Project (AICSIP) developed 15 sorghum varieties (CSV 1 to CSV 15) and 18 hybrids (CSH 1 to CSH 18 R). CSH 1, CSH 6 and CSH 9 are best for kharif season. CSH 15 R and 18 R is best for rabi season. The hybrids and varieties recommended for different parts of rainfed region in India are given in Table 15.6.

Table 15.6. Hybrids /Varieties Recommended

<i>Hybrids/Varieties</i>	<i>Season</i>	<i>Grain yield (t/ha)</i>	<i>Dry fodder yield (t/ha)</i>	<i>Duration (days)</i>
Hybrids				
CSH-1	Kharif (June-July)	3.0	7.5	95–100
CSH-6		3.4	8.1	95–100
CSH-9		3.9	9.8	105–110
CSH-11		4.1	9.2	105–110
CSH-13		3.9	14.4	105–110
CSH-16		4.2	9.1	110
CSH-17		4.2	10.4	103
CSH-18		4.1	13.1	112
Varieties				
CSV 11	Kharif (June-July)	3.2	9.6	110–115
SPV 462–CO 26		3.3	9.7	110–115
CSV 15		3.6	12.1	107–112

(Contd.)

Hybrids				
CSH 13R	Rabi (October-	3.2	5.4	113
CSH 15R	November)	3.2	5.6	110
Varieties				
CSV 14R	Rabi	2.3	5.5	117
CSV 8R	(October- November)	2.2	4.8	120
Swati		2.2	5.3	117

In Tamil Nadu, the important varieties are CO 26, COH 3 (105–110), K 8, CO 19(145), K10, Paiyur-1 (140–145), Paiyur-2 (Sencholam) (90–95 days), APK 1, and BSR1. In southern districts, a traditional variety Irungu cholam is cultivated and in northern districts, the varieties like K.Tall, COH 3, COH 4, CO 25, CO 26 and BSR 1 are cultivated. The varietal details are given in Table 15.7.

Table 15.7. Variety Details

Variety	Duration (days)	Grain yield (t/ha)	Fodder yield (t/ha)
CO 26	105–110	4.5	14.00
K10	110–115	1.6	16.00
CO 25	115–120	3.68	13.25
K tall	90	3.75	11.25
K 8	85	2.4	7.30
APK 1	105–110	2.60	8.00
BSR 1	105–110	3.00	7.20

Seed rate: The seed rate is 15 kg/ha.

Seed treatment: For seed hardening, the seeds are soaked in 2% KH_2PO_4 or 500 ppm of CCC/cycocel for six hours and shade dried for 5 hrs. Using 350 ml of solution is sufficient for soaking 1 kg of seed. It is a method by which drought tolerance is induced in plants by soaking the seeds in weak electrolytes or salt solution. Seed treatment is done with Azospirillum and phosphobacteria each 3 pockets (600 gm). In main field, application of 2 kg of Azospirillum and 2 kg of phosphobacteria with 25 kg of FYM + 25 kg of soil is recommended. Then, the seeds are treated with Thiram/Bavistin @ 2 g/kg of seeds. If possible, the seed is palletized with 15 g of chlorpyrifos in 150 ml of gum before sowing and seeds are dried.

Sowing: The seeds are sown before onset of monsoon at 5 cm depth with seed cum fertilizer drill or by seed drill or by country plough. Pre monsoon sowing/dry seeding *i.e.*, sowing a week or 2 weeks before on set of monsoon is followed:

District	Optimum period
Coimbatore	37–38th week (2nd–3rd week of September)
Erode	38th week (3rd week of September)
Sivagangai and Ramnad	40th week (1st week of October)
Thoothukudi, Tirunelveli	39–40th (Last week of September to 1st week of October)

Spacing: The spacing for sole crop of sorghum is 45 × 15/10 cm (1,80,000 plants/ha) and 60/30 × 15 cm for intercropping and paired row system.

Manuring: Application of FYM or compost at 12.5 t/ha during last ploughing is recommended. Application of NPK at 40:20:0 kg/ha is recommended. 'P and K' is applied basally as enriched FYM. 'N' may be applied in two splits viz., 50% basal and 50% at 25 DAS depending upon the rainfall. In high rainfall areas of north India where sorghum is grown during SWM (kharif season), the recommended NPK is: 80:40:40 kg/ha where 50% N, and entire P and K should be applied as basal, remaining 50% N as top dressing at 25–30 DAS depending on the rainfall. During rabi season, the recommended application of NPK is 40:20:0 kg/ha. Entire fertilizer is applied as basal by drilling method.

Growth stages: There are five growth stages.

1. Seedling stage	: 1–15 days
2. Vegetative stage (Grand growth (30–40))	: 16–40 days
3. Flowering/Reproductive stage	: 41–65 days
4. Maturity	: 66–95 days
5. Ripening	: 96–105 days

Weed management: Keeping the sorghum fields free of weeds from 2nd week after germination till 5th week is good. If sufficient moisture is available, spraying atrazine @ 500 g/ha (atrazine 0.25 kg/ha) as pre-emergence within three days after receipt of soaking rain followed by one late hand weeding/inter cultural operation may be done. For sorghum based intercropping system with pulses, pre-emergence application of pendimethalin (Stomp 30 EC) at 3.0 lit/ha followed by one hand weeding at 35 DAS is recommended.

Striga: There are three species of striga viz., *Striga asiatica*, *S. lutea*, *S. hermonthica* (witch weed). It is a semi-root parasite in sorghum and reduces the yield markedly. The control measures for striga in sorghum are as follows:

- Post emergence application of 2,4-D Na salt at 2.0 kg/ha at 25–30 DAS
- Intercropping with red gram
- Crop rotation with trap crops like cotton, sunflower, groundnut, cowpea, etc., which induce germination of weed seeds, but they are not themselves parasitized
- Heavy application of N and FYM and flooding the field
- Spraying Urea 10% solution on 25–30 DAS
- Using germination stimulants like Strigol and ethylene gas

Cropping system: The important intercropping systems in Tamil Nadu are given below:

Southern districts	Sorghum + cowpea (2:1); sorghum + black gram (2:1)
Coimbatore	Sorghum + green gram (4:2); sorghum + sunflower (4:2)
Aruppukottai	Sorghum + fodder cowpea (1:1)
Dharmapuri	Sorghum + lab-lab (4:1); sorghum + red gram (3:1)

In north India, the important systems during kharif season (SWM) are given below:

Sorghum + red gram at	3:1 ratio
Sorghum + soybean at	4:2 ratio
Sorghum + green gram at	4:2 ratio.

The important double cropping systems in rainfed areas are given below:

North India:	Sorghum–chickpea/safflower Grain legumes–rabi sorghum (green gram/red gram)
Tamil Nadu:	Sorghum–horse gram (Dharmapuri areas) Groundnut–fodder sorghum (Pollachi tract)

Thinning: Thinning should be completed 10–15 days after emergence leaving one plant per hill.

Harvesting and threshing: Most of the high yielding varieties and hybrids mature in about 100–115 days. The right stage for harvest is, when the grain becomes hard having less than 25% moisture. Do not wait for stubble and leaves to dry, because hybrid sorghum appears green even after the crop is matured. Harvest may be done at physiological maturity. Harvesting is done by cutting the entire plant or removing the ear heads first and cutting down the plants later and is allowed to dry for 2–5 days. Threshing is done with the help of thresher or beating the ear heads. The threshed grain is dried in the sun for a week to bring the moisture content to 10–12% for safe storage.

Yield: The grain yield varies from 2–3 t/ha under rainfed conditions and the dry stover yield varies from 8–10 t/ha.

II. Irrigated Sorghum

It is raised by either direct seeding or transplanting. Irrigated transplanted crop has advantages like main field duration is reduced by 10 days; shoot fly attacks will be economically controlled in the nursery; seedlings which show chlorotic and downy mildew symptoms can be eliminated; optimum population can be maintained as only healthy seedlings are used and seed rate is reduced by 2.5 kg/ha.

Varieties: *CO 25* (115–120 days, grain yield of 6.0 t/ha, straw yield of 17.5 t/ha), *CO 26* (105–110 days, grain yield of 6.0 t/ha, straw yield of 19.0 t/ha), *BSR 1* (105–110 days, grain yield of 6–6.5 t/ha, straw yield of 9.6 t/ha).

Hybrids: *CSH 5* (100 days, grain yield of 4.5 t/ha, straw yield of 12.5 t/ha), *COH 4* (105–110 days, grain yield of 6.5 t/ha, straw yield of 20.0 t/ha), *COH 5* (100 days, grain yield of 6.8 t/ha, straw yield of 19.0 t/ha).

Season: In Tamil Nadu, it is cultivated in two seasons *viz.*, January–February (Thaipattam) and April–May (Chithirai pattam).

Seed rate: The seed rate for direct sowing is 10 kg/ha and 7.5 kg/ha for transplanting.

Nursery

- (i) **Preparation:** For planting one ha, about 7.5 cent (300 m²) nursery area is required, near the water source. Application of 750 kg of FYM or compost for 7.5 cent nursery is done and another 500 kg for covering the seeds after sowing is used. Forming raised beds of 2 m × 1.5 m with 30 cm spacing to a depth of 15 cm is done. Pre treatment of seeds for both direct seeded crop and raising in the nursery is must. The seeds are treated 24 hours before sowing with carbendazim/captan/thiram @ 2 g/kg of seed. And then, the seeds are treated with 2% KH₂PO₄ for 6 hours and shade dried for 5 hours. The seeds are treated with 3 packets of Azospirillum (600 g/ha) using rice kanji as binder.
- (ii) **Sowing:** Forming rills using fingers, broad casting the seeds and covering with 500 kg of FYM is done.
- (iii) **Irrigation:** Irrigations are given immediately after sowing, 3rd day, 7th day, 12th day and 17th day (Totally five irrigations).

- (iv) **Transplanting:** Age of seedling is 15-18 days. The seedlings are dipped in Azospirillum solution (5 packets -1000 g) dissolved in 40 lit. of water) for 15-30 minutes. Planting at 45 × 15 cm spacing at a depth of 3-5 cm with one seedling per hill on the side of ridge is done.

Main field preparation (direct seeded and transplanted crop: Sorghum does not require fine tilth. The field is ploughed with an iron plough once and twice with a country plough. To overcome the sub soil hard pan in Alfisol, chiseling the field at 0.5 m interval to a depth of 40 cm on both the direction of the field followed by disc ploughing once and cultivator ploughing twice is done. Application of 12.5 t FYM or compost/ha with 2 kg of Azospirillum (10 pockets/ha) is recommended. Ridges and furrows are formed at 45 cm apart using ridge plough.

Fertilizer management

Transplanted crop: If soil test recommendation is not available, the blanket recommendation of 90:45:45 kg NPK/ha is recommended. 50% N and entire P and K should be applied basally before planting and remaining 50%N is applied on 15 DAS.

Direct seeded crop: Blanket recommendation of 90:45:45 kg NPK/ha is followed. Application of 50% N, and entire P and K should be applied basally and the remaining 50% N on 25-30 DAS.

Micronutrient: For Zn deficient soils, 25 kg ZnSO₄/ha is applied at the time of sowing/transplanting. If ZnSO₄ is not applied basally and if Zn deficiency is noticed, ZnSO₄ at 0.5% concentration is sprayed. For Fe deficient soils, 50 kg FeSO₄ is applied at sowing or at planting. If FeSO₄ is not applied basally, FeSO₄ 1% concentration at 2 or 3 stages is sprayed.

Spacing: The spacing is 45 × 15 cm (1,48,000 plants/ha) for both direct and transplanted crop. For raising intercrop and paired row system, a spacing of 60/30 × 15 cm may be adopted. Raising one row of pulses in between 60 cm row spacing is common.

Thinning and gap filling: In the direct sown crop, thinning one seeding per hill and gap filling the thinned out seedlings is done on 10-15 DAS, maintaining a spacing of 15 cm between plants.

Weed management: Sorghum is slow growing in the early stage and is adversely affected by weed competition. Keeping the fields free of weeds up to 45 days is good. Pre-emergence herbicide Atrazine 50 WP at 500 g/ha (atrazine 0.25 kg/ha) on 3 DAS using high volume sprayer followed by one hand weeding on 30-35 DAS is recommended. If pulse crop is raised as intercrop, do not use atrazine. If herbicide is not used, for transplanted crop, two hoeing and weeding on 10 and 30-35 DAS should be done. In the case of direct seeded crop, two hand weeding on 15-20 DAS and 35-40 DAS should be done.

Water management: Total water requirement is 450-500 mm. Irrigation at 50% depletion of available soil moisture or 0.6 IW/CPE ratio is sufficient. There are four critical stages viz., (1) seedling, (2) vegetative, (3) flowering, (4) dough stages. Stress at one week before and one week after flowering is very critical. Under moisture stress condition, 5 irrigations are sufficient. For normal condition, 8 irrigations are to be given i.e. on 1st day, 4th day, 15th, 28th, 40th, 53th, 64th, 76th and 88th days. Irrigation should be stopped after 88-90 DAS. As contingent plan, spraying 3% Kaolin (30 g in one litre of water) during periods of stress will mitigate the ill effects.

Harvesting and processing: When the crop matures, leaves turn yellow and the grains are hard and firm and moisture content will be less than 25%. At this stage, the earheads are cut separately and dried for 2-3 days and threshing using mechanical thresher is done and the grain is dried to 12% moisture for safe storage. The straw is cut after a week and allowed it to dry and then stacked for fodder.

Cropping system

In Tamil Nadu, the following cropping systems are being followed:

- Sorghum–Ragi,
- Sorghum–Cotton,
- Sorghum–Onion,
- Sorghum–Green gram.

Intercropping

The sorghum crop is intercropped with Cowpea and Green gram.

III. Ratoon Sorghum

It is highly amenable for ratooning. The varieties suited for ratooning are CO 25, CO 26, CSH 5 and K.Tall.

Ratooning technique: The main crop is harvested leaving 15 cm stubble in the field and first formed two sprouts are removed from the main crop and allowed only the latter formed two sprouts to grow. Two tillers per hill are allowed.

Hoeing and weeding: The weeds are removed immediately after harvest of main crop. Hoeing and weeding is done on 15th and 30th day after cutting.

Application of fertilizers: Application of 100:50:0 kg NPK/ha is recommended. N is applied in two splits doses viz., 1st dose on 15th day after cutting and second on 45th day after cutting. P_2O_5 is applied along with first application of N.

Pest and disease management: Since the ratoon crop invites pests and diseases in early stages, plant protection measures have to be resorted to.

Water management: Irrigation is given immediately after cutting the main crop. Irrigation should not be delayed for more than 24 hours after cutting. Then, irrigation is given 3rd or 4th day after cutting and subsequent irrigations are given once in 7–10 days. Irrigation is stopped 70–80 days after ratooning.

Harvest: Similar to sown crop but duration is 10–15 days lesser than main crop.

Yield: Yield is equal or slightly higher than sown crop.

2. FINGER MILLET (RAGI, MANDUA) *Eleusine coracana* L. Gaertn.

It is cultivated mainly in Asia and Africa. It is staple food crop in many hilly regions of the country and it is grown both for grain and forage. In Northern hills, grains are eaten in the form of chapaties and in South India, grain flour is used for preparing gruel, cakes or unleavened bread, puddings, porridges, sweets etc. Germinating grains are malted and fed to infants and good for pregnant woman. It is considered as nutritive food for adults of different ages. Grains contain 9.2% protein, 1.29% fat, 76.32% carbohydrates, 2.24% minerals 3% ash and 0.33% Ca. It also contains vitamins A and B with small amount of P. It is good for persons suffering from diabetes. Green straw is suitable for making silage.

Origin: India. It is cultivated in India, Africa, Sri Lanka, Malaysia, China and Japan.

Area and Production: In India, it is cultivated in an area of 19.1 lakh ha with a production 27.62 lakh t and productivity of 1440 kg/ha. It is predominantly grown in the peninsular Indian states of Karnataka, Andhra Pradesh, Orissa, Uttar Pradesh and Tamil Nadu. The production is high in Karnataka, followed by Tamil Nadu, Uttar Pradesh, Orissa and Andhra Pradesh. The average productivity is high Tamil Nadu, followed by Karnataka and Uttar Pradesh.

Soil and Climate: It is grown in wide variety of soils and it thrives well in well-drained loam or clay loam. It tolerates salinity better than other cereals. It is a tropical and sub-tropical crop, grows from sea level to 2100 m on hill slopes and it is grown in areas having average rainfall 50–100 cm. In higher rainfall areas, it is raised as transplanted crop.

Seasons: It is cultivated in three seasons namely kharif, rabi and summer. Kharif and Rabi crops are rainfed, while summer crop is irrigated. In Karnataka, Andhra Pradesh and Tamil Nadu, it is grown in rabi (September-October) as irrigated crop.

Varieties: Varieties cultivated are Godavari, Indaf 5, Sarada, PR 202, BR 407, EC 4840, CO 7, CO 11, CO 12.

Table 15.8. Variety Particulars

<i>Particulars</i>	<i>Indaf 5</i>	<i>CO 11</i>	<i>CO 12</i>	<i>CO 13</i>
Duration (days)	105–100	90–95	110–120	95–100
Grain yield (kg/ha)				
Irrigated	4000	4750	4750	3600
Rainfed	2500	3250	3250	2300
Straw yield (kg/ha)				
Irrigated	7500	8750	8750	10000
Rainfed	5200	6250	6250	7500
<i>Growth stages</i>	<i>80 days crop</i>	<i>100 days crop</i>	<i>120 days crop</i>	
Vegetative phase (nursery)	1–16	1–18	1–20	
Vegetative phase (main field)	1–18	1–20	1–22	
Flowering	19–40	21–55	23–69	
Maturity	Beyond 40	Beyond 55	Beyond 69	

Package of practices for Tamil Nadu

Seasons (Irrigated)	Marghazipattam (December-January)–CO11, K7, CO 13 Chithirapattam (April-May)–CO 11, K 7, CO 13
Rainfed	Adipattam (June-July)–Co 11, K 7, Paiyur-1 Purattasi pattam (September-October)–CO 11, K 7, CO 12

(a) **Irrigation for nursery:** The following is the schedule for water management in nursery.

<i>No. of irrigations</i>	<i>Red soil</i>	<i>Heavy soil</i>
1st	Immediately after sowing	Immediately after sowing
2nd	3 DAS	4 DAS
3rd	7 DAS	9 DAS
4th	12 DAS	16 DAS
5th	17 DAS	

(b) **Pulling out seedling:** Pull out the seedlings on 17–20 DAS for planting.

Main field preparation and planting: The field is ploughed thoroughly to get a fine tilth with mould board plough. FYM or compost or composted coir pith at 12.5 t/ha is incorporated. Application of NPK is done as per soil test or a blanket recommendation of 60:30:30 of NPK kg/ha is recommended. Half N and full P and K are applied basally. Application of 10 packets of azospirillum/ha by mixing with 25 kg sand and 25 kg FYM before transplanting is done or root dipping is done for 15–30 minutes with Azospirillum 5 packets (1000 g) in 40 lit water. Beds of 10–20 m² are formed with suitable irrigation channels. Application of 12.5 kg micronutrient mixture with enough sand is done and the mixture should not be incorporated. Let water in to the bed and level the bed. Planting 18–20 days seedlings at 2/hill at a depth of 3 cm with a spacing of 15 × 15 cm is done. The remaining half N is top dressed in two equal splits on 15th and 30th day after transplanting coinciding the weeding. In the case of aged seedlings beyond 21 days, the number of seedlings is increased to 3/hill and N by 25% is increased to reduce the loss.

Water management: Generally, in heavy and light soils, totally 9 irrigations are required. Depending upon the duration of the crop (80, 100 and 120 days) and stage of the crop, one or two or three irrigations may be skipped or given. The critical stages are tillering and preflowering stages.

Weed management: Application of Butachlor 2.5 l/ha or Fluchloralin 2 l/ha or pendimethalin 2.5 l/ha as pre-emergence with 900 l of water is done and if sufficient moisture is not available, irrigation is done immediately. If pre-emergence herbicide is not applied, hoeing and hand weeding is done on 15th and 30th day after transplanting. For rainfed directed seeded crop, application of post emergence herbicide like 2,4-DEE or 2,4-D Na salt at 0.5 kg/ha is done on 10th day after sowing depending on moisture availability.

Cropping system: It is intercropped with legumes like field beans, cowpea, and fodder sorghum or occasionally with other millets. About 4–5 rows of ragi with a row of field bean is very common in Karnataka and Andhra Pradesh. Ragi is sequenced with groundnut, horse gram, cotton, tobacco or sesame.

Pest and disease management: To control mosaic virus, spraying Monocrotophos 36 WSC 0.05% is recommended. To control blast, spraying of carbendazim 250 g/ha is recommended. If needed, 2nd and 3rd spray may be given at 15 days interval after 1st spray. To control root aphids, dimethioate at 3 ml is mixed with 1 of water and drenching is done.

Harvesting: It does not mature uniformly and hence harvest is done in two stages. 1st harvest is done when ear head of main shoot and 50% of ear heads turn brown. Cutting and drying the ear heads is done. Then, threshing and cleaning is done. Second harvest is done seven days after first harvest. All the ear heads including green ones are cut with sickles first then the straw is harvested. Curing is done by heaping the harvested ear heads in shade for one day without drying to make greener ear heads to mature. Then drying, threshing and cleaning are done. Harvested heads are threshed using conventional beating with sticks and treading under the feet of animals. Machine threshing is also common in some areas.

3. PEARL MILLET (OR) BAJRA (OR) CUMBU IN TAMIL (*P. glaucum*)

It is a staple food crop of about 100 million peoples in rural areas of India and Sub Saharan Africa. Roti or Chapatti, which are unleaved flat breads prepared using pearl millet flour are common in Asia. Porridges and cooked grains are also used. In northern India, it is prepared during winter while wheat becomes common in summer diet. It is also used for fried preparations, foods such as fermented products and beer. Varieties of pancakes are prepared using pearl millet flour in Africa and pearl millet beer is used throughout Africa. Fura or cheese is the traditional African snacks prepared using steamed

pearl millet flour and cream. It is used as fodder in Africa and Asia. Oxalic acid content is very high. So it is not relished by cattle. It is rich in protein (12.6%) and fat (5%), fibre (1.2%) and 60–70% of Carbohydrate. It is normally rich in Ca, Vitamin Riboflavin and Carotenoides. In Central America, it is mainly cultivated for forage purpose. It is also grown as pasture grass. Of the 150 sps of *Pennisetum*, *P. glaucum* is the cultivated species for grain and *P. purpurea* is the forage species.

Origin-Africa

Area, Production and Distribution: It is largely grown in India. The important pearl millet producing countries are India, Africa, Pakistan, China, Sudan and Egypt. In India, it is cultivated in an area of 10 m.ha with a production of 7.9 m.t and productivity of 791 kg/ha. Area under cultivation is high in Rajasthan, followed by Maharashtra, Gujarat and Uttar Pradesh. The production is more in Rajasthan, followed by Maharastra, Gujarat, Tamil Nadu and Uttar Pradesh. In Tamil Nadu, it is cultivated in an area of 2.3 l.ha with production of 2.5 l.ton and productivity of 1226 kg/ha. In Tamil Nadu, it is grown in all the districts, except Kanchipuram, Tiruvallur and Nilgris.

Stages: There are four crop stages namely seedling stage (1–18 days), Tillering stage (19–35 days), Flowering phase (36–55 days) and Maturity phase (56–85 days)

Climate: It is a rapid growing, warm weather crop and it has resistance for drought. The best temperature is between 20 and 28°C. It can withstand even desiccation. It is highly suitable for the areas having rainfall ranges from 400–750 mm. Even 150 mm of rainfall is sufficient. Rainfall during vegetative phase is highly favourable, while rainfall at flowering is not conducive, as it washes off the pollen and there is a poor seed setting. The crop grows better in light showers followed by bright sunshine. Usually bajra is grown, where it is not possible to grow sorghum because of high temperature and low rainfall. It is grown as kharif crop in Northern India, while in Tamil Nadu, Karnataka and Punjab, it is grown under irrigated condition during summer.

Soil: It is grown in a wide variety of soils, but being sensitive to water logging. It grows well in well drained sandy loams. It is sensitive to acidic soil. It is grown successfully in black cotton soil, alluvial soils and red soils of India.

Time of sowing: In India, it is grown in three seasons viz., kharif (rainfed-June–October), winter (rainfed–November-February) and summer (rain fed–March-June). During summer, it is grown in Tamil Nadu, Karnataka, Punjab and Gujarat as an irrigated crop.

Hybrids: Under All India Co-ordinated Research project, many hybrids have been developed. Using Cytoplasmic male sterile line (CMS line), five hybrids have been developed. Among them, HB-3 is the best. But all hybrids are susceptible to downy mildew. To overcome the downy mildew, CMS line MS.5071 was used and five New Hybrid bajra were developed. Among them, NHB.5 is the best for disease resistance and wide adaptability besides giving higher yield. In Tamil Nadu, using CMS line MS 5141 A, two hybrids X 6 and X 7 were evolved and are recommended for cultivation.

X6: 90–100 days, irrigated crop yields 3236 kg/ha and rainfed crop yields 2394 kg/ha. It is resistant to downy mildew.

X7: 90 days, irrigated crop yields 3295 kg/ha and rainfed crop yields 2513 kg/ha. It is resistant to downy mildew.

Composite: WCC 75 (World Cumbu Composite developed at ICRISAT, Hyderabad) is suited for both irrigated and rainfed. Duration is 95 days. Irrigated crop yields 3.0 t and rainfed crop yields 2.0 t/ha.

Variety: CO 7–90–100 days duration. Rainfed crop yields 2.5 t/ha and irrigated crop yields 3.5 t/ha. It is resistant to downy mildew.

K3: 85 days duration.

Package of practices for Tamil Nadu

A. Variety and Hybrids

I. Irrigated Crop

1. March–April (Chithiraipattam) – WCC 75, K 3, CO 7, X 6, X 7
(All district except Kanchipuram, Tiruvallur and Nilgris)
2. January–February (Masipattam) – WCC 75, CO 7, X 6, X 7.
(except Kanchipuram, Tiruvallur and Nilgris)

II. Rainfed

1. June–July (Adipattam) WCC 75, K 3, CO 7, X 6, X 7
2. Sept–Oct (Purattasipattam) WCC 75, K 3, CO 7, X 6, X 7,

B. Method of Raising

Irrigated condition: (a) Raising seedling in the Nursery and transplanting. (b) Direct sowing.

Rainfed crop: Direct seeding either broadcasting or sowing behind country plough.

C. Seed Rate and Seed Treatment

The seed rate for direct sowing is 5 kg/ha and for transplanting, it is 3.75 kg/ha. Ergot affected seeds are removed using salt solution (1 kg of NaCl in 10 lit of water), to prevent primary infections and shade dried. Seed treatment is done with fungicides-captan or thiram 2 g/kg of seed, followed by Azospirillum seed treatment (3 pockets or 600 g/ha seed rate).

D. Transplanted Crop

Nursery preparation: Nursery area required is 7.5 cents (300 m²) for one ha. The land is ploughed in such a way to bring fine tilth. Application of 750 kg of FYM or compost is done and incorporated. Raised beds of 3.0 m × 1.5m with 30 cm channel are formed. Small rills not deeper than 1 cm on the raised bed are opened. About 3.75 kg of seeds is sown in 7.5 cents at 0.5 kg/cent and 500 kg of FYM or compost is used for sprinkling for covering the seeds.

<i>Irrigation</i>	<i>Light soil</i>	<i>Heavy soil</i>
1st	immediately after sowing	immediately after sowing
2nd	3rd DAS	3rd DAS
3rd	7th day	9th day
4th	12th day	16th day
5th	17th day	

Field preparation for both irrigated and rainfed crop: Deep ploughing with Iron plough and country plough is to be done twice to bring fine tilth. If there is hard pan, chisel ploughing is done. About 12.5 t/ha of FYM or compost is applied during last ploughing. Application of Azospirillum to the soil is done @ 10 packets/ha (2 kg).

Land Shaping: For irrigated crop (transplanting), either ridges and furrows at 45 cm apart or beds of convenient size depending upon the water availability are formed. For rainfed crop, flat sowing is followed. For rainfed crop, Pora method of sowing is better than Kera method.

Transplanting: Pull out of the seedlings is recommended when age of seedling is 15–18 days. A spacing of 45 × 15 cm for all the varieties except CO 7 is adopted. For CO 7, spacing is 35 × 15 cm (similar row spacing is adopted for rainfed crop also). Dipping the roots in bio-fertilizer Slurry (dissolve 5 packets of Azospirillum in 40 lit. of water) for 15–30 minutes may be done. Planting one seedling/hill to a depth of 3–5 cm is recommended.

Direct sown crop: Soaking the seed in 2% potassium chloride or 3% NaCl for 6 hours followed by shade drying for 5 hours is done. As in transplanted crop, a spacing of 45 × 15 cm for all varieties except CO 7 and for CO 7, 35 × 15 cm row spacing is adopted. If pulse is intercropped, a spacing of 35 × 15 cm for cumbu and 30 × 10 cm for cowpea and other pulses is adopted. Seed rate is 5 kg/ha.

Fertilizer management: If soil test recommendation is not available, the blanket recommendation is followed as given below:

Irrigated crop:	Hybrids	80 : 40 : 40 kg N : P ₂ O ₅ : K ₂ O/ha.
	Varieties	70 : 35 : 35 kg N : P ₂ O ₅ : K ₂ O/ha.
Rainfed crop:		40 : 20 : 0 kg N : P ₂ O ₅ : K ₂ O/ha.

Application of 50% N and 100% P and K is recommended as basal at 5 cm depth and the remaining 50% N at 15 days after planting for transplanted crop and 30 DAS for direct sown crop is applied. It removes about 90 kg N, 20–25 kg, P₂O₅ and 160 kg K₂O. For Zn deficient soil, application of ZnSO₄ at 25 kg/ha is done. Iron deficiency occurs in saline and calcareous soil. Based on the level of deficiency, 12.5–25 kg of FeSO₄ is recommended. If it is not applied basally, foliar application of 1% FeSO₄ at vegetative phase is recommended.

Water management: It is a highly drought tolerant crop and water requirement is 300–350 mm. Irrigation at available soil moisture of 50% or optimum IW/CPE ratio 0.4 is sufficient. The critical stages are tillering and flowering. Normally 5 irrigations are recommended for the stages viz., tillering, panicle initiation, flag leaf, flowering, dough stages in addition to sowing irrigation. Under limited moisture conditions, three irrigations can be recommended for panicle initiation, flag leaf and flowering in addition to sowing irrigation.

Thinning and gap filling: In the direct sown crop, after 1st weeding at the time of irrigation, gap filling and thinning is done to a spacing of 15 cm between plants. In rainfed crop, thinning should be done 10–15 DAS.

Weed management: Weed reduces the yield by 50%. Crop weed competition is up to 35 days. Pre-emergence application of atrazine at 500 g/ha followed by hand weeding on 30–35 days after transplanting or sowing. If the herbicide is not used, weeding is done on 15th day and again between 30 and 35 days after transplanting. For direct sown crop, hoeing and weeding may be done on 20–25 DAS and second weeding on 35–40 DAS. Atrazine should not be used for intercropping systems.

Cropping system: Some of the important crop rotations are:

1. Bajra – Barley	Intercropping system in North India
2. Bajra – Wheat	Bajra + Groundnut
3. Bajra – Gram	Bajra + Black gram
4. Bajra – Pea	Bajra + Green gram
5. Bajra – Potato	Bajra + Castor
	Bajra + Cowpea

Harvesting and Threshing: When the leaves turned yellow colour and when the seeds become hardened and having 20% moisture, harvesting is done by removing the earheads first and cutting down

the plants latter on. The ear heads after harvesting should be dried well in sun before threshing. The grains are separated either by beating the ear heads by sticks or by trampling by bullocks. If mechanical thresher is available, thresh it or spread it and drag a stoneroller over it. The threshed grain should be cleaned and dried in the sun to bring the moisture to 12–14% for safe storage.

Yield	Grain yield (t/ha)	Stover yield (t/ha)
Irrigated	3.0–3.5	10.0
Rainfed	1.2–1.5	7–7.5

15.4 SMALL/MINOR MILLETS

The small millets or minor millets have potentiality to grow even under adverse ecological condition and very poor agro-climate regions where main food crops cannot be grown. The five small millets are:

- | | | |
|--------------------|---------------------------|----------------------------------|
| 1. Italian millet | (Thenai, Kakun, Fox tail) | : <i>Setaria italica</i> |
| 2. Kodo millet | (Varagu) | : <i>Paspalum scrobiculatum</i> |
| 3. Common millet | (Panivaragu, Cheena) | : <i>Panicum millaceum</i> |
| 4. Little millet | (Samai) | : <i>Panicum milliare</i> |
| 5. Barnyard millet | (Kudiraivali, Sawan) | : <i>Echinochloa frumentacea</i> |

1. ITALIAN MILLET (*Thenai, Kakun, Fox tail*)

It is generally grown as rainfed crop. Grains are cooked like rice and it contains 12.3% protein, 4.7% fat, 60.6% carbohydrates and 3.2% ash. Grain flour is used in the form of chapaties. Grains are fed to cage birds. Straw is thin stemmed and is liked by cattle (not good for horses). In China, it is important next to rice and wheat and provides approximately 15–17% of the total food consumed in China.

Origin: China

Area and distribution: It is cultivated in India, China, Eastern Europe, Southern parts of former USSR and some extent in African and American countries. In India, it is cultivated in Karnataka, Andhra Pradesh, Madhya Pradesh and Uttar Pradesh.

Soil and climate: It can grow in poor soils but requires fairly fertile soils for good yields. Light soils including red loams, alluvial and black cotton soils are all suitable for its cultivation but it thrives best on rich, well-drained loam soils. It is cultivated in tropical and temperate regions up to 2000 m altitude. It requires moderate temperature and grows successfully with 50–75 cm rainfall. Although water requirement is less, it has no capacity to recover after long spell of drought

2. KODO MILLET (*Varagu*)

It is a highly drought tolerant crop and it can be grown in areas where rainfall is scanty and erratic. It has coarsest food grains covered with horny seed coat, which should be removed before cooking. Immature and molded grains are poisonous. It can be easily preserved and it proves as good famine reserve and recommended as a substitute for rice to patients suffering from diabetes. Grain contains 8.3% protein, 1.4% fat, 65.6% carbohydrates and 2.9% ash.

Origin: India

Area and distribution: It is grown mostly in Andhra Pradesh, Maharashtra, Karnataka, Tamil Nadu and Uttar Pradesh.

Soil and climate: It is grown from gravelly and stony upland poor soils to loam soils and it comes well under adverse conditions and even in poor soils, some yield can be obtained. It thrives best on well

drained sandy loam to loamy soils. It makes rapid growth in warm and dry climate and requires rainfall of 400–500 mm.

3. COMMON MILLET (*Panivragu, Cheena, Proso millet*)

The common millet offers better prospects for intensive cultivation in dry land areas and evades drought by its quick maturity. Grain contains 12.5% protein, 1.1% fat, 68.9% carbohydrate, 2.2% crude fibre and 3.4% ash. It is rich in lysine (4.6%), which is inadequate in most cereals. It is used as cooked grain, flour for making chapatis, perched grains etc. It makes good poultry feed and straw is a good fodder.

Origin: India

Area and Distribution: It is grown extensively in India, Japan, China, Egypt, Arabia and Western Europe. In India, it is largely grown in Madhya Pradesh, Eastern Uttar Pradesh, Bihar, Tamil Nadu, Maharashtra, Andhra Pradesh and Karnataka.

Soil and Climate: Well drained loam or sandy loam, free of kankar and rich in organic matter is ideal for cultivation of common millet. It can be grown both in rich and poor soils having variable texture ranging between sandy loam and clays of black cotton soils. It is a warm climate crop grown extensively in warm regions of the world and it is a highly drought resistant and can be grown in areas where there is scanty rainfall. It can withstand water stagnation to certain extent.

4. BARNYARD MILLET (*Kudiraivali, Sawan*)

It is a very drought resistant crop and also capable of withstanding water logging condition. Grains are consumed just like rice and used in making rice pudding. Grain contains 6.2% protein, 9.8% crude fibre, 65.5% carbohydrates and 4.4% ash. It is mostly eaten by poor class people and sometime brewed for beer. It is used as feed for cage birds and straw makes good fodder for cattle.

Origin: India

Table 15.9. Packages of Practices for Small Millets

<i>Particulars</i>	<i>Italian millet</i>	<i>Kodo millet</i>	<i>Common millet</i>	<i>Little millet</i>	<i>Barnyard millet</i>
Season and varieties (Rainfed)	<u>June-July</u> CO 5, K 3, CO 6	K1, CO 3, APK Niwas1, Pali	1 PV196 and 162, K1, CO 2, CO 3, CO 4 and K 2	CO 2, CO 3 K 1, CO 3	IP 149, VL 1 CO 1, K 1, PT 8, IPI 49
Seed rate (kg/ha)	Line planting –10 and broadcasting- 12.5	Line planting –10 and broadcasting – 12.5			
Seed drill	Gorru seed drill is recommended				
Seed treatment	2 g thiram or carbendazim				
FYM (t/ha)	12.5				
Nitrogen (kg/ha)	44 (basal)				
Phosphorus (kg/ha)	22 (basal)				

(Contd.)

<i>Particulars</i>	<i>Italian millet</i>	<i>Kodo millet</i>	<i>Common millet</i>	<i>Little millet</i>	<i>Barnyard millet</i>
Spacing (cm)	22 × 10	45 × 10	25 × 10	25 × 10	25 × 10
Weeding	15 DAS- 1st weeding 40th DAS- 2nd weeding				
Thinning	20 DAS				
Yield (kg/ha)	1200–1800	1500–1800	1200–1500	700–1300	1250–1750
Harvesting	The whole plant or ear head is sickled, staked and dried and threshed with stone roller or trampling under feet of bullocks				

Area and Distribution: It is cultivated in India, China, Japan, Malaysia and West Indies and to some extent in Africa and USA. In India, it is grown in Madhya Pradesh, Uttar Pradesh, Tamil Nadu, Andhra Pradesh, Karnataka, Maharashtra and Bihar.

Soil and climate: It can be grown in soils of marginal fertility and partially water logged condition. It thrives well in sandy loam to loamy soils. It can be grown from sea level to 2000 m msl. Warm and moderately humid climate is good.

Cultivation of small millets: The packages of practices for small millets are given in Table 15.9.

5. SAMAI

Samai	It is cultivated in Dharmapuri, Vellore, Tiruvanamalai, Erode, Salem, Namakkal, Coimbatore, Madurai, Dindugul, Theni, Tirunelveli and Thoothukudi.	
Seasons	Variety	Duration (Days)
(a) June-July (Hill slopes of Coimbatore and Erode Districts)	CO 2, CO 3, CO 6	55, 85–95
July–August (Dharmapuri)	Paiyur 1, CO 3	55, 90 and 80–95
September–October	K 1, CO 3	100, 80–85
September–October	CO 5, CO 6	90, 85–90

CO 3 for all samai growing areas of Tamil Nadu. The variety particulars are given below:

<i>Particulars</i>	<i>Samai K 1</i>	<i>Samai CO 2</i>	<i>Samai Paiyur 1</i>	<i>Samai CO 3</i>
Parentage	Reselection from PM 368	Selection Ananthapur	Pureline	Selection from germ plasm bank
Duration (days)	90	80–85	105–110	80–85
Pigmentation	Green	Green	–	–
Tillering ability	Moderate	Moderate	Moderate	High
Panicles	Loose, Open	Well branched open & loose	Semi compact Long	–
Grain Character	Buff Colour	Brown & small	Brown	Brown

(Contd.)

<i>Particulars</i>	<i>Samai K 1</i>	<i>Samai CO 2</i>	<i>Samai Paiyur 1</i>	<i>Samai CO 3</i>
Grain Yield (kg/ha) Rainfed	1300	700	870	1066
Special features	–	–	–	Bold grain, Non lodging suits for early and late sowing

Seeds and sowing: The seed rate for line planting is 10 kg/ha and 12.5 kg/ha for broadcasting. Use of Gorru or seed drill is recommended.

Seed treatment: The seeds are treated with 2 g Thiram or Carbendazim/kg of seeds.

Field preparation: Plough the field thoroughly 2 or 3 times using a small iron plough or country plough to fine tilth.

Fertilizer application: Application of 12.5 t/ha FYM/Compost, 44 kg N/ha and 22 kg P₂O₅/ha as basal is recommended. The spacing for line planting is 25 × 10 cm.

Weeding: First weeding is done on the 15th DAS and the second weeding on 40th DAS.

Thinning: Thinning is done soon after weeding or before 20 DAS.

Plant protection: Usually no major problem of pests and diseases.

15.5 PULSES

India is the largest producer and consumer of pulses. Dried edible seed of a cultivated legume is known as pulse. Legume derived from Latin “legere” means “to gather”. It constitutes 10–12% of Indian diet. WHO recommends 80 g/day/person, whereas ICMR recorded 47 g but actual is 30–35 g. Pulses are used as fodder, food crops, green manure, cover crop and catch crop. N fixation by legumes improves soil fertility. The protein content ranges from 17–25% (Soybean = 40–43%). It provides thiamine, riboflavin, niacin, vitamin B and ascorbic acid. Early maturity, relative thermo and photo insensitivity and better canopy structure (non-spreading) makes the pulses to include them in multiple cropping.

Area and distribution: India accounts 33% area under pulses and 22% production of world. It is mostly grown as rainfed and only 8% of pulse area is irrigated in India. Pulses are cultivated in an area of 22.47 m.ha with 13.38 m.t production (2004–05). The pulse yield potential in India is 2500–3500 kg/ha but the productivity is 550–625 kg/ha as against 1600 kg in USA, 1400 kg in China and world average is 900 kg/ha.

Causes for low production of pulses

- Ecological factors:** Pulses are grown mostly under rain fed conditions and only 8% of the area is irrigated and it depends on residual soil moisture. Pulses are sensitive to excess soil moisture, salinity, alkalinity and acidity.
- Lack of agronomic management:** It is grown with poor management and lack of HYV (HI-0.1–0.2 and but, for wheat, it is 0.5). Improper sowing time, inadequate seed rate and defective method of sowing are few examples.
- Basic research factors:** Break through in production is possible if HYV/hybrid is developed with synchronous flowering, multiple resistance to pests and diseases and response to inputs.

(d) **Socio-economic constraints:** It is grown by resource poor farmers often as catch crop or mixed crop or in rotation with commercial or high yielding cereal crop. Unassured market is a reason for low production.

(e) **Constraints in post harvest technology:**

1. RED GRAM (*Cajanus cajan*)

It is the second most important pulse crop, next to gram. There are two species viz., *C. cajan* var. *flavous-Tur* (Early), *C. cajan* var. *bicolour-Arhar* (late). It is primarily used as dal, while the tender green seeds are consumed as vegetable, crushed dried seeds as animal feed and green leaves as fodder. Stem is used as fuel wood and to make huts and baskets, used for paper pulp. Leaves can be used to feed silkworm and plants are used to culture lac insect. It serves as windbreak and live fence. Venezuela local soft drink known as 'Chicha' is made and canned for export by freezing. It accounts for 12% pulse area, 17% pulse production and 90% world production.

Origin: India

Area and distribution: It is cultivated in Africa, West Indies, Sri Lanka, Australia and Malaya, India, Indo China. In India, it is cultivated in an area of 3.61 m.ha with a production of 2.7 m.t. and productivity of 747 kg/ha. Major growing states are Maharashtra (16.5 lha), Uttar Pradesh (5.0 lha), Karnataka, Madhya Pradesh, Gujarat, Andhra Pradesh. Production is very high in Maharashtra, followed by Uttar Pradesh, Gujarat, Madhya Pradesh where as the productivity is high in Haryana and Bihar. In Tamil Nadu, the area under cultivation is 1.40 l.ha with a production of 1.20 l.t and productivity of 864 kg/ha.

Soil and Climate: It is grown in wide range of soil from sandy loam to clay loams. Best soils are fertile, well drained loamy soils, Suitable pH range is 5–8. It grows up to 1500 m msl and well distributed rainfall of 500–900 mm in tropics and subtropics is sufficient. It requires temperature range of 10–40°C and the optimum temperature is 20–28°C.

Season and Varieties: It is grown in kharif (June–August) and rabi (September–November).

CO 5, CO 6, Vamban 1, Vamban 2	– Resistant to sterility mosaic
BSR 1, SA1 and CO 4	– Suitable for bund planting.
Hybrids: ICPH 8 from ICRISAT	– yield is 4 t/ha.
COH 1, COH 2	

Spacing: The depth of seeding is 5 cm. The seed rate is 20–30 kg/ha. For bund planting, the seed requirement is 50 g/100 m row. In vertisols, broad bed furrows (BBF) are best with 90 cm beds and 60 cm shallow furrow.

Long and medium duration varieties	: 75 × 30 cm
Short duration	: 45 × 30 cm
Rain fed	: 90 × 30 cm

Seed treatment: The seeds are treated with Carbendazim or Thiram @ 2 g/kg seed 24 hours before sowing (or) *Trichoderma viridie* @ 4 g/kg of seed (or) *Pseudomonas fluorescense* @ 10 g/kg. Fungicide treated seeds should be again treated with 3 pockets bacterial culture 15 minutes before sowing

Fertilizer application: For a production level of 2 t grain and 6 t stalks, red gram removes 132 kg

N, 20 kg P₂O₅ and 53 kg K₂O per ha. Phosphorus is the most limiting nutrient and response is about 6–10 kg grain/kg of applied P. Application of 12.5 kg N + 25 kg P₂O₅/ha basally before sowing under rain fed conditions and 25 kg N + 50 kg P₂O₅/ha under irrigated conditions is recommended. Soil application of 25 kg DAP/ha and foliar application of 25 kg DAP/ha with 25 kg S as gypsum (110 kg/ha) or 2% urea in two sprays at flower commencement and 15 days after may be given for getting higher yield.

Weed management: Application of Fluchloralin at 1.5 l/ha (or) pendimethalin 2 at 1/ha on 3 DAS, followed by one hand weeding may be given on 30–35 DAS. If no herbicide is applied, two hand weedings on 15 and 35 DAS are recommended.

Water management: Water use efficiency of legumes is 500 kg water/kg DMP, while for cereals, it is 300–350 kg water/kg DMP. Water requirement of red gram is 500–600 mm. To produce 1 t of grain, 200–250 mm water is used. Irrigation should be given for the stages *viz.*, immediately after sowing, 3rd DAS, bud initiation, 50% flowering and pod development stages. Water stagnation at any stage should be avoided.

Cropping Systems

Intercropping: The important cropping systems are sorghum + red gram, ragi + red gram, red gram + urd and red gram + groundnut at 1:6 ratio.

Crop rotation: This crop is rotated with maize/rice-red gram, red gram-wheat.

Harvesting: Harvesting is done the plants when 80% of the pods are matured. Then, the plants are stacked for a few days. The pods are separated with sticks and grains are separated from husk and dried to optimum moisture level (10–12%).

Yield: Yield ranges from 2 to 4 t/ha.

2. BENGAL GRAM (*Gram, Chickpea*) (*Cicer arietinum*)

It is the most important pulse crop of India, which constitutes 37% area, and 50% production of pulses and nearly 75% in acreage and production. It is predominantly consumed as dhal or for preparing variety of snack foods, sweets and condiments. Fresh gram serves as vegetable and eaten raw. Bhusa is used as cattle feed. Husk and split beans are useful as livestock feed. It contains 17–21% protein, 4.5% fat and 61.0% carbohydrate. An acidic liquid from glandular hairs of the plant are collected at night, which contain 94% maleic acid and 6% oxalic acid that has medicinal value and used in preparation of vinegar.

Origin: South-west Asia, probably Afghanistan and/or Persia.

Distribution: It is cultivated in India, Pakistan, Myanmar, Ethiopia and Turkey. In India, it is cultivated in Bihar, Haryana, Madhya Pradesh, Maharashtra, Punjab, Rajasthan and Uttar Pradesh.

Types: There are two types of Bengal gram.

1. **Kabuli types:** Constitutes 15% production and the seeds are large (> 26 g/100 g seeds), more or less rounded and pale cream colour.
2. **Desi types:** Constitutes 85% production and the seeds are smaller in size (17–26 g/100 seeds), irregular shapes and various colours.

Soil and climate: It is grown on wide range of soils from medium to heavy black soils, mixed red and black soils or in alluvial soils but requires well drained loam or sandy loam. It is generally grown in areas, which receive annual rainfall of 800 mm and altitude of 1800 m from sea level. The pH range

is between 5.5 and 8.6, and optimum pH range is 5.7–7.2. It does not withstand water logging and saline alkaline conditions. It is a long day plant and optimum temperature requirement is 24°–32°C .

Field preparation: The land is prepared to get fine tilth and beds and channels are formed. To tide over surface soil crusting, application of lime @ 2t/ha along with FYM at 12.5 t/ha or composted coir pith to get additional yield of 15–20%.

Season and varieties- Mid October-early November is the optimum time of sowing in India.

Desi varieties:	Radhey,G-24, BR-78, RS-11, Ujjain-24, Chaffa, CO-2, CO-3, CO-4
Kabuli varieties:	HC-3, K-5, C-104, L-550, L-144

Seed treatment: Chemical seed treatment with carbendazim or thiram @ 2 g/kg of seed is done and then, after interval of 24 hours, the seeds are treated with 3 packets (600 g) suitable strains of Rhizobium biofertiliser with rice gruel 15 minutes before sowing. Instead of chemical treatment, the seeds can be treated with *Trichoderma viride* @ 4 g/kg or *Pseudomonas fluorescence* @ 10 g/kg followed by biofertilizer. Seeds are soaked in 1% KH_2PO_4 for 4 hours and then shade dried before sowing.

Seed rate: The seed rate for kabuli type is 80-100 kg/ha and for desi type, it is 60–75 kg/ha.

Fertilizer application: Application of fertilizers is done basally before sowing. The recommended fertilizer dose is given below.

Rainfed:	12.5 kg N + 25 kg P_2O_5 /ha
Irrigated:	25.0 kg N + 50 kg P_2O_5 /ha

Sowing: The spacing for Kabuli type is 45 × 10 cm and 30 × 10 cm for desi type. Depth of sowing is 10 cm. Pora method is better than broadcast and furrow covering should be followed with plank.

Water management: It is grown mostly as rainfed crop. Flowering and pod filling stages are critical stages. Avoid water stagnation at all stages of crop growth.

Weed management: Application of fluchloralin 1.5 l/ha or pendimethalin 2.0 l/ha as pre-emergence on 3 DAS followed by one hand weeding on 30 DAS is recommended. If herbicides are not applied, two hand weeding on 15th and 30th DAS is recommended.

Cropping systems: In Tamil Nadu, paired row planting of one or two rows of coriander gives higher net return. It is also intercropped with cotton, wheat barley and sunflower. The common crop rotations are rice-chickpea, maize-chickpea, groundnut-chickpea, green gram-chickpea, sesame-chickpea and black gram-chickpea.

Harvesting: The plants are harvested when all the pods are matured. Stack and thresh the pods and extract seeds. The average yield is 0.7 t/ha. A good crop of desi variety can yield 1.5–2.0t/ha while Kabuli varieties can yield 2.5–3.0 t/ha. The average yield in Tamil Nadu is 1.0 t/ha.

3. GREEN GRAM (*Vigna radiata*) (Moong, Mung, Golden gram)

It is relished for easy digestibility as dhal or split seeds and green pods are used as vegetables. Haulms are used as fodder. Husk and split beans are useful as livestock feed. It makes a good cover crop and soil binder. It is excellent green manure (1.5% N and easily decomposed when incorporated). It contains 24% protein, 1.15% fat and 62.6% carbohydrate. Seeds are boiled and used in soups, made into porridge with rice or wheat. Sprouted seeds are consumed as salad, which are rich in vitamins. Flour is used in cakes and deserts and starch is used in making noodles. The low content of oligosaccharides results in low flatulence. Being a short duration crop, it is well fitted in many intensive crop rotations.

Origin: India and Central Asia.

Distribution: It is cultivated in India (45% world production), Myanmar, Pakistan, Thailand, Sri Lanka, Indo-China, Indonesia and China. In India, it is cultivated in Andhra Pradesh, Orissa, Madhya Pradesh, Maharashtra, Bihar and Gujarat.

Soil and climate: Ideal soils are well drained loam or sandy loam and saline alkali soils are not suitable. Optimum pH range is 6.5–7.5. An annual rainfall of 600–750 cm is sufficient for the crop growth. It is grown from sea level to 2000 m. Optimum temperature requirement is 28°–30°C. It is a short day plant.

Field preparation: The land is prepared to get fine tilth and beds and channels are formed. To tide over surface soil crusting, application of lime @ 2t/ha along with FYM at 12.5 t/ha or composted coir pith is practiced to get additional yield of 15–20%.

Season and varieties: It is grown as kharif and summer crop in north India, but in South and South West India, it is grown as rabi crop. The important varieties cultivated in India are Type 44, Pusa Baisakti, Jawahar-45, K-851, Sheela, PS-16, Pant Mung-1 and Mohini (S8). The season and varieties recommended for Tamil Nadu is given Table 15.10.

Table 15.10. Season and Varieties

Season	Month	Varieties
Kharif (Adipattam)	June–July	CO 4, CO 5, KM 2, T 9, VBN 1, Paiyur 1
Rabi (Purattasipattam)	September- October	K 1, CO 5, KM 2, VBN 1, Paiyur 1
Rice fallows	January - February	ADT 2, ADT 3
Summer	February - March	CO 4, KM 2, Paiyur 1

Seeds and seed treatment: Seed rate is 20 kg/ha for pure crop, 10 kg/ha for mixed crop, 25 kg/ha for rice fallows and 50 g/100 m length for bund sowing. The seeds are treated with carbendazim or thiram @ 2 g/kg of seed, then after interval of 24 hours, treated with 3 packets (600 g) suitable strains of Rhizobium biofertiliser with rice gruel 15 minutes before sowing. Instead of chemical, the seeds are treated with *Trichoderma viride* @ 4 g/kg or *Pseudomonas fluorescense* @ 10 g/kg followed by biofertilizer.

Fertilizer application: In general, 1 t of green gram removes 43 kg N, 3–4 kg P and 10–12 kg K. Application of fertilizers is done basally before sowing as below:

Rainfed:	12.5 kg N + 25 kg P ₂ O ₅ /ha
Irrigated:	25.0 kg N + 50 kg P ₂ O ₅ /ha

For rice fallow crop, 2% DAP at the time of first appearance of flower and 15 days later or spray 40 ppm NAA at the time of first appearance of flower and 15 days later is recommended.

Sowing: Dibbling the seeds is done adopting spacing of 30 × 10 cm (for line sown crop). Broadcasting may be done in the standing crop 5–10 days before the harvest uniformly at optimum moisture condition (seeds should get embedded in the waxy mire) under rice fallow condition. Dibbling is done at 30 cm spacing on wetland bunds as bund crop.

Water management: For line sown pure crop, irrigation is given immediately after sowing followed by life irrigation on the 3rd day and then, at interval of 10–15 days depending on soil moisture conditions. For wetland bund crop, pot watering is done daily for a week after sowing. Flowering and pod formation stages are critical periods. Water stagnation should be avoided at all stages. In some places, sprinkler irrigation is followed especially for summer crop.

Weed management: Application of fluchloralin 1.5 l/ha or pendimethalin 2.0 l/ha as pre-emergence (3 DAS) followed by one hand weeding on 30 DAS is recommended. If herbicides are not applied, two hand weeding on 15th and 30th DAS is recommended.

Cropping systems: Intercropping is common practice where one or two rows of green gram with maize, pearl millet, sorghum, pigeon pea, cotton and sugarcane. It is rotated with wheat and potato in India.

Harvesting: The plants are harvested when 80% of the pods are matured and the plants are stacked for few days before threshing.

Yield: The average yield is 700–900 kg/ha for rain fed condition, 1500 kg/ha for irrigated and 500 kg/ha for rice fallow condition.

4. BLACK GRAM (URD) (*Vigna mungo*)

Being a short duration crop, it fits well in many intensive crop rotations. It is also used as green manure crop. It is mainly consumed as dhal or split seeds (husked and unhusked) and husked dal is ground into a fine paste and allowed to ferment with rice flour to make 'dosa' and 'Idli' (a south Indian favourite food). The peculiarity of black gram is when ground with water develops mucilaginous character giving additional body to the mass. It contains 25% protein, 1.83% fat, 61.0% carbohydrate. It is a chief constituent of 'papad'. Haulms are used as fodder. Husk and split beans are useful as livestock feed. It possesses deep root system, which binds soil particles and prevents erosion.

Origin: India.

Distribution: It is cultivated in India, Pakistan, Bangladesh, Myanmar and Sri Lanka. In India, it is cultivated in Madhya Pradesh, Maharashtra, Andhra Pradesh, Tamil Nadu, Uttar Pradesh and Orissa.

Soil and climate: Ideal soils are well drained loam or sandy loam. Optimum pH range is 5.5–7.5. It is generally grown in areas which receive annual rainfall of 800 mm and areas of 1800 m msl.

Field preparation: The land is prepared to get fine tilth using disc plough and country plough and beds and channels are formed. To tide over surface soil crusting, application of lime @ 2 t/ha along with 12.5 t/ha FYM or composted coir pith is done to get additional yield of 15–20%.

Season and varieties: It is grown as kharif and summer crop in north India, but in South and South west India, it is also grown as rabi crop. The important varieties cultivated in India are Type-9, Type-27, Type-56, Pusa-1, Mosh-48, Pant-430, Gwalior-2, Khargone-3, Ujjain-4, Naveen, Krishna, Sarla and UG218

Season	Month	Varieties
Kharif (Adipattam)	June–July	CO 4, CO 5, KM 2, T 9, VBN 1, VBN 2
Rabi (Purattasipattam)	September–October	K1, CO 5, KM 2, VBN 1, VBN 2
Rice fallows	January–February	ADT 2, ADT 3, ADT 4, ADT 5, TMV 1
Summer	February–March	CO 4, CO 5, KM 2, T 9, TMV 1, ADT 5

Seed treatment: Seed rate is 20 kg/ha for pure crop, 10 kg/ha for mixed crop, 25 kg/ha for rice fallows and 50 g/100m length for bund sowing. Chemical seed treatment is done with carbendazim or thiram @ 2 g/kg of seed then after interval of 24 hours, the seeds are treated with 3 packets (600g) suitable strains of Rhizobium biofertiliser with rice gruel 15 minutes before sowing. Instead of chemical, the seeds are treated with *Trichoderma viride* @ 4 g/kg or *Pseudomonas fluorescence* @ 10 g/kg followed by biofertilizer. For Pre-monsoon sowing, the seeds are treated with paste made of ash (500 g/kg of seeds) + 3% gum and drying is recommended for 5 hours.

Fertilizer application: Application of 12.5 kg N + 25 kg P₂O₅/ha for rainfed crop and 25.0 kg N + 50 kg P₂O₅/ha for irrigated crop as basally before sowing is recommended.

Sowing: as in the case of green gram.

Water management: Irrigation is given as in the case of green gram. In some places, sprinkler irrigation is followed especially for summer crop. Application of 0.5% KCl as foliar during vegetative stage, if there is moisture/water stress.

Weed management: As in green gram crop.

Cropping systems: Intercropping is common practice where one or two rows of black gram with maize, pearl millet, sorghum, pigeon pea, cotton and sugarcane. This crop is rotated with maize-wheat-urd, maize-potato-urd, rice-wheat-urd in north India.

Harvesting: The plants are harvested when 80% of the pods are matured and the plants are stacked for few days before threshing.

Yield: The average yield is 600-700 kg/ha for rain fed condition, 1000–1300 kg/ha for irrigated and 500 kg/ha for rice fallow condition.

5. HORSE GRAM (KULTHI, KOLLU) (*Macrotyloma uniflorum*)

The crop is predominantly a South Indian crop and termed as poor man's legume. It serves the farmer excellently under subsistence farming conditions and it is suited to marginally poor soils and those deficient in N. It is rich in protein and used for human consumption. Cooked seeds possess an earthy flavour and the soups are nutritious. Roasted grains are salted and consumed as confectionary items. It is used as animal feed particularly horse and cattle (boiled, salted and fed). Freshly cut plants are excellent fodder source in South India. It contains 22% protein, 1.0% fat and 62.0% carbohydrate.

Origin: India.

Distribution: Horse gram, South-east Asian crop, is predominantly grown in South India. It is cultivated in Karnataka, Andhra Pradesh and Tamil Nadu. It is less frequently grown in central states and in the hilly slopes of Himachal Pradesh and Uttar Pradesh.

Soil and climate: Horse gram has excellent adaptability to drought and harsher environments prevailing in semi arid and it is grown in scanty rainfall (less than 750 mm) areas. It is grown on wide range of soils such as sandy, loamy or even deep vertisols and as first crop on marginal lateritic soils.

Field preparation: The land is prepared to get fine tilth.

Season and varieties: The best season is October–November. The important varieties in Tamil Nadu are CO-1, Paiyur-1 and Paiyur-2. The varieties in other states are Hebbal Hurali-2, HPK-2, VZM-2, PGH-9 and BGM-1.

Seeds and seed treatment: Chemical seed treatment is done with carbendazim or thiram @ 2g/kg of seed, then after interval of 24 hours, the seeds are treated with 3 packets (600 g) suitable strains of Rhizobium biofertilizer with rice gruel 15 minutes before sowing. The seed rate is 20–25 kg/ha and if grown primarily for fodder, seed rate of 40 kg/ha is recommended.

Fertilizer application: Application of 12.5 t/ha of compost or FYM and 12.5 kg N + 25 kg P₂ O₅/ha basally before sowing is recommended.

Sowing: The spacing is 30 × 10 cm. The seeds are dibbled at 30 cm row spacing and thinning is done to 10 cm in the row.

Weed management: One hand weeding and hoeing is done between 20 and 25 DAS is recommended.

Harvesting: Matured pods suitable for harvest are slightly brittle and straw coloured. Plants are uprooted at harvest, stacked for few days to dry, later threshed by beating to separate the grains by winnowing. Green fodder yield is 10 t/ha. Grain yield ranges from 0.5 to 0.8 t/ha.

6. COWPEA (*VIGNA UNGUICULATA*) (*Lobia*, *Black eyed pea*, *China pea*)

Cowpea grains are used for human consumption and green pods as vegetables. Being rich in protein and

other nutrients, it is known as vegetable meat. It makes a good cover crop and there by prevents soil erosion. The leaves and haulms are rich sources of fodder and hay is more digestible than alfalfa. It is an excellent green manure. It contains 23.4% protein, 1.8% fat and 60.3% carbohydrate (also rich in Ca and Fe). It is an alternate pulse crop for dry land farming.

Origin: Africa (Nigeria).

Distribution: It is mainly grown in Africa (90%) and Nigeria is the world's largest producer. It is also cultivated through out Sub-Saharan Africa, South-east Asia, Latin America, Australia and USA. In India, it is mainly grown in central and peninsular India and in Northern India, it is grown in Uttar Pradesh, Punjab, Delhi and Haryana. In Tamil Nadu, it is cultivated as an intercrop in few places.

Soil and climate: Ideal soils are well drained loam or sandy loam and saline alkali soils are not suitable and optimum pH range is 6.0–7.5. The crop thrives best between temperature of 27° and 35°C. It can withstand drought to certain extent.

Field preparation: The land is prepared to get fine tilth and beds and channels are formed.

Season and varieties: It is grown in kharif, rabi and summer seasons. The important varieties grown in India are C-152, Pusa Sawani, Gujarat Cowpea 1 and 2, PTB 1 (Kanakamani) and PTB 2 (Krishnamani). Highly valued vegetable cowpea is 'Pusa Baisaki'. In Tamil Nadu, the varieties are cultivated in different seasons, which is given in Table 15.11.

Table 15.11. Seasons and Varieties

Season	Month	Varieties
Kharif (Adipattam)	June–July	CO 2, CO 3, CO 4, CO 6, KM 1, Paiyur 1
Rabi (Purattasipattam)	September–October	CO 2, CO 3, CO 4, CO 6, KM 1, Paiyur 1, VBN 1, VBN 2
Summer	February–March	CO 4, CO 2, VBN 2

Seed rate and seed treatment: Seed rate is 20 kg/ha for pure crop, 10 kg/ha for mixed crop and 40 kg/ha for fodder and green manure crop. The seed treatment is done with carbendazim or thiram @ 2 g/kg of seed and then, after interval of 24 hours, the seeds are treated with 3 packets (600 g) suitable strains of Rhizobium biofertilizer with rice gruel 15 minutes before sowing. Instead of chemical treatment, the seeds are treated with *Trichoderma viride* @ 4 g/kg or *Pseudomonas fluorescence* @ 10 g/kg followed by biofertilizer.

Fertilizer application: Application of fertilizers basally before sowing for rainfed crops @12.5 kg N + 25 kg P₂O₅/ha and for irrigated crops at 25.0 kg N + 50 kg P₂O₅/ha is recommended. Application of 20 kg K₂O/ha is beneficial for lateritic soils in increasing the yield. For rice fallow crops, 2% DAP spray at the time of first appearance of flower and 15 days later or 40 ppm NAA (Planofix) at the time of first appearance of flower and 15 days later is given.

Sowing: The seeds are dibbled adopting a spacing of 30 × 15 cm or 45 × 15 cm depending on variety.

Water management: Irrigation is given immediately after sowing followed by life irrigation on the 3rd day and then, at interval of 10–15 days depending on soil moisture conditions. For wetland bund crops, pot watering is to be given daily for a week after sowing. Flowering and pod formation stages are critical periods of irrigation.

Weed management: Fluchloralin at 1.5 l/ha or pendimethalin at 2.0 l/ha as pre-emergence (3 DAS) followed by one hand weeding on 30 DAS is recommended. If herbicides are not applied, two hand weeding on 15th and 30th DAS are recommended.

Cropping systems: It is usually mixed with maize, sorghum, millets and cassava. The crop rotations are maize-wheat-cowpea, rice-wheat-cowpea, cowpea-wheat-cheena and jowar + cowpea-berseem-maize + cowpea.

Harvesting: The plants are harvested when 80% of the pods are matured and threshing is done after drying. The grain yield is 1000–1500 kg/ha and if it is raised for fodder, green fodder yield is 25–35 t/ha.

7. GARDEN LABLAB (*Avarai*) (*Lab lab purpureus var. typicus*)

The green pods are mostly used as vegetables. Grains are used for human consumption. The leaves and haulms are also used as fodder. It is suggested by villagers in Tamil Nadu that the green pods are good for the persons having diabetics and high blood pressure.

Soil and climate: Ideal soils are well drained loam or sandy loam and saline alkali soils are not suitable. Optimum pH range is 6.0–7.5. The crop thrives best between temperature of 27° and 35°C.

Field preparation: The land is prepared to get fine tilth and beds and channels are formed for bushy types and pits of one cubic foot for Pandal types. In Tamil Nadu, it is grown as pandal crop in all villages and even in town areas.

Season and varieties

Season	Month	Varieties
Kharif (Adipattam)	June–July	CO 3, CO 4, CO 5, CO 6, CO 8, CO 9, CO 10, CO 11, CO 12, CO 13,
Rabi (Purattasipattam)	September–October	CO 3, CO 4, CO 5, CO 6, CO 7, CO 8, CO 9, CO 10, CO 11, CO 12, CO 13,
Summer	February–March	CO 3, CO 4, CO 5, CO 6, CO 8, CO 9, CO 10, CO 11, CO 12, CO 13, CO 7

Seeds and seed treatment: The seed rate for CO 3, CO 4, CO 5, CO 6, CO 7 and CO 8 varieties is 4 kg/ha. Seed rate for CO 9, CO 11 and CO 12 is 20 kg/ha and for CO 10 and CO 13, it is 25 kg/ha for pure crop and 12.5 kg for mixed crop. The seed treatment is done with carbendazim or thiram @ 2 g/kg of seed and then, after interval of 24 hours, the seeds are treated with 3 packets (600 g) suitable strains of Rhizobium biofertilizer with rice gruel 15 minutes before sowing.

Fertilizer application: Application of fertilizers basally before sowing for rainfed crops @ 12.5 kg N + 25 kg P₂O₅/ha and for irrigated crops at 25.0 kg N + 50 kg P₂O₅/ha is recommended. For pandal varieties, 115 g each in Ammonium sulphate and super phosphate may be applied.

Sowing: The seeds are dibbled adopting a spacing 90 × 90 cm (Climber) for CO 3, CO 4 and CO 5 varieties, 45 × 15 cm for CO 6, CO 7, CO 8, CO 9, CO 10, CO 11 and CO 12 varieties, and 45 × 30 cm for CO 13.

Water management: Irrigation is given immediately after sowing followed by life irrigation on 3rd day and then, at interval of 10–15 days depending on soil moisture conditions. Flowering and pod formation stages are critical periods of irrigation

Weed management: Two hand weeding may be done (first between 20 and 25 DAS and second at 45 DAS).

Pruning technique: Spacing of 10 feet between lines and four feet between plants is adopted. Pits are dug (one cubic foot) and 2–3 seeds are sown in the middle of the pit. One healthy seedling is allowed to grow and rest will be removed. The vine is propped with a stick. When the vine reaches the

pandal, the terminal bud is nipped. Allow the branches to trail over the pandal. Each branch may be pruned at three feet length so that pandal is covered with vines. Branches arising on the main vine below the pandal are removed. When flowering starts, prune the tip of the branches bearing the inflorescence having three nodes from the productive axils. Continue the procedure throughout the reproductive phase.

Harvesting: The pods are picked when they are completely dry. The pods are threshed and cleaned the beans. The tender pods are picked once in a week for vegetable use and grain yield is 5–7.5 t/ha and green pod yield is 10–15 t/ha.

8. FIELD LABLAB (*Lab lab purpureus var. lignosus*) (Mochai)

Grains are used for human consumption and found to supply all the amino acids required for disease resistance. The leaves and haulms are also used as fodder.

Soil and climate: Ideal soils are well drained loam or sandy loam and saline alkali soils are not suitable.

Field preparation: The land is prepared to get fine tilth.

Season and varieties

<i>Season</i>	<i>Month</i>	<i>Varieties</i>
Kharif (Adipattam)	June–July	CO1 and CO2
Rabi (Purattasipattam)	September–October	CO2
Summer	February–March	CO2

Seeds and seed treatment: The seed rate for CO1 is 20 kg/ha for pure crop and 10 kg/ha for mixed crop. Seed rate for CO2 is 25 kg/ha for pure crop and 12.5 kg/ha for mixed crop. The seed treatment is done with carbendazim or thiram @ 2 g/kg of seed and then, after interval of 24 hours, the seeds are treated with 3 packets (600 g) suitable strains of Rhizobium biofertilizer with rice gruel 15 minutes before sowing.

Fertilizer application: Application of fertilizers basally before sowing for rainfed crops @12.5 kg N + 25 kg P₂O₅/ha and for irrigated crops at 25.0 kg N + 50 kg P₂O₅/ha is recommended.

Sowing: The seeds are dibbled adopting a spacing 90 × 30 cm pure crop and 200 × 30 cm–mixed crop for CO1 and 45 × 15 cm–pure crop and 200 × 15 cm–mixed crop for CO2.

Water management: Irrigation is given immediately after sowing followed by life irrigation on 3rd day and then, at interval of 10-15 days depending on soil moisture conditions. Flowering and pod formation stages are critical periods of irrigation.

Weed management: Two hand weeding may be done (first between 20 and 25 DAS and second at 45 DAS).

Harvesting: Dry pods are collected for grain purpose. Green matured pods are collected and extracted grains for vegetable purpose.

9. SOYBEAN (*Bhat, Ramkulti*) *Glycine max*

Soybean is the richest, cheapest and easiest source of best quality protein and fat and having a vast multiplicity of uses as food and industrial products and hence called as wonder crop. Soybean serves as an important fat and protein source for large population residing in Asia and American continents. It contains 20% oil and 40% high quality protein. Large number of Indian and western dishes are prepared using soybean. It is used for making high protein food for children. Soybean oil is used for

making vanaspathi and several other industrial products like antibiotics. The crop builds up soil fertility by N fixation (as high as 160 kg N/ha and an average of 100 kg N/ha). It can be used as fodder and forage can be made into hay and silage. Cakes are excellent nutritive foods for livestock and poultry.

Origin: Eastern Asia or China.

Distribution: It is grown in USA, China, Brazil, Mexico and former USSR countries. China and USA together contributes 60% of world production. In India, it is cultivated in Madhya Pradesh, Uttar Pradesh, Maharastra, Gujarat, Himachal Pradesh and Punjab. The production of soybean in our country is 78,62,000 t and with a productivity of 1210 kg/ha.

Soil and climate: The best soil is well drained fertile loam soils with a pH of 6.0–7.5. Saline and sodic soils inhibit germination while acidic soils require lime application. It can be cultivated in these soils with proper reclamation methods. Water logging is injurious. Optimum temperature requirement is 26.5°–30°C but it is grown in wide range of temperature (5°–40°C). It grows well in warm and moist climate.

Field preparation: The land is prepared well to get fine tilth.

Season and varieties: In north India, soybean can be planted from third week of June to first fortnight of July. It is grown in kharif, rabi and summer seasons in Tamil Nadu. In delta areas, it is grown as rice fallow crop during middle of January to middle of March.

<i>Season</i>	<i>Month</i>	<i>Varieties</i>
Kharif (Adipattam)	June–July	CO1 and CO 2
Rabi (Purattasipattam)	September–October	CO 1 (irrigated), CO 2
Summer	February–March	CO 1, CO 2, ADT 1
Rice fallow	January–February	UGM 21, UGM 37, ADT 1

Seeds and seed treatment: The seed rate for CO1 is 80 kg/ha and 60–70 kg/ha for CO2. The seed treatment is done with carbendazim or thiram @ 2 g/kg of seed and then, after interval of 24 hours, the seeds are treated with 3 packets (600 g) suitable strains of Rhizobium biofertilizer with rice gruel 15 minutes before sowing. The seed coating is done with ZnSO₄ @ 300 mg/kg using 10% maida solution as adhesive (250 ml/kg) or gruel and arappu leaf powder (250 g/kg) as carrier to increase the field stand.

Fertilizer application: Application of 20 kg N, 80 kg P₂O₅ and 40 kg K₂O along with 40 kg of S as gypsum (220 kg/ha) per ha is recommended as basal under irrigated conditions. 2% DAP foliar spray is given on 40 DAS. Salicylic acid at 100 ppm as foliar spray on 30th and 45th day is also recommended to increase the yield. For rainfed crops, application of 20:40:20 NPK kg/ha is recommended as basal. For Zn deficient soils, application of 25 kg ZnSO₄ along with 12.5 t FYM is done basally. For Mn deficient soils, application of 25 kg MnSO₄ along with 12.5 t FYM is done basally and if basal application is not given, 1% MnSO₄ spray may be given on 20–30 DAS and 40 DAS.

Sowing: The seeds are dibbled adopting a spacing of 30 × 5 cm for irrigated crop and 30 × 10 cm for rainfed crop. Depth of sowing is 2–3 cm.

Water management: Irrigation is given immediately after sowing followed by life irrigation on 3rd day and then, at interval of 7–10 days during summer and 10–15 days in winter days depending on soil moisture conditions. The crop should not suffer due to water stress from flowering to maturity. To alleviate moisture stress, spraying of Kaolin 3% or liquid paraffin 1% on the foliage is recommended.

Weed management: Pre-emergence application of Fluchloralin at 2.0 lit/ha or pendimethalin at 3.3 lit/ha followed by one hand weeding on 30 DAS is recommended. If herbicide is not applied, two hand weeding (first at 20 DAS and second at 35 DAS) is done.

Cropping system: Soybean is recommended for intercropping with sugarcane, maize, sorghum and cotton. It is generally rotated with wheat–potato–gram–tobacco and potato–wheat.

Harvesting: Yellowing of leaf and shedding indicates the maturity. The entire plant is cut when most of the pods have turned yellow. The pods are dried adequately in sun and threshed with sticks to separate the grain. Hand threshing is done for seeds purpose and dried to 8% moisture. The seeds are treated with Thiram @ 2 g/kg and packed in 300 gauge thick poly lined gunny bag or ordinary gunny bag to maintain germination of 70% for 8 months.

10. MOTH BEAN (*Dew gram*) (*Phaseolus aconitifolius*)

Moth bean is an important pulse crop in desert region and drought tolerant. It is suited to arid and semiarid regions. It is grown for fodder, green manure and cover crop and it improves soil fertility.

Origin: India.

Distribution: It is cultivated in India, Thailand, China, Africa and Southern USA. In India, the important growing states are Rajasthan, Haryana and Gujarat.

Season: July.

Varieties: Most of the varieties are local and have spreading habit, indeterminate, Viny and late maturing. They are prone to shattering and susceptible to yellow mosaic.

Rajasthan	: Jadia
Gujarat	: Baleswar 12, Mevi
Fodder type	: J 3, RMO 40

Soil and climate: Sandy loam with neutral pH is ideal for dew gram. Saline and alkali soils are not suited. It is a warm weather crop and can be grown in summer season.

Field preparation: The crop needs minimum land preparation. Pre-sowing irrigation for proper germination is must.

Seed rate: Seed treatment may be done as per other pulses. It can be sown behind the country plough with depth of 4–5 cm. The seed rate for pure crop is 12–15 kg/ha and the spacing between rows is 40–50 cm. The seed rate for mixed crop is 4–5 kg/ha with a spacing of 10–15 cm between plants. The seed rate for fodder crop is 20–25 kg/ha.

Manures and fertilizers: Application of FYM at 8–10 t/ha, 15–20 kg N and 40–45 kg P₂O₅/ha as basal is recommended. For saline soils, application of 15–20 kg ZnSO₄/ha may be done once in 3 years.

Weed management: Application of Fluchloralin @ 1kg a.i./ha as pre-emergence herbicide or hand weeding twice on 20–25 and 30–35 DAS may be followed.

Crop rotation: The common crop rotations are given below:

<i>Rainfed</i>	<i>Irrigated</i>
Sorghum–moth bean–barley	Moth bean–potato–wheat
Moth bean–pearl millet–mustard	Moth bean–radish–wheat
Moth bean–gram	Moth bean–toria–potato
Moth bean–mustard	

Yield: The yield ranges from 600 to 800 kg/ha.

11. PEAS (*Garden pea and Field pea*) (*Pisum sativum*)

There are two types:

- 1. Garden pea (*P. sativum* var. *hortense*):** It is also known as table pea. The crop is harvested in immature condition and used for cooking as green vegetables. Seeds are bold and wrinkled with yellowish, whitish or bluish green in colour. The flowers are white in colour.
- 2. Field pea (*P. sativum* var. *arvense*):** It is mainly grown as forage crop for cattle; as green manure crop for soil improvement and as cover crop to reduce soil erosion. Matured seeds are used as whole or split. Flowers are coloured. Seeds are rounded and little angular with grayish to brown/green/yellow in colour.

Origin: Mediterranean region of Southern Europe and Western Asia.

Distribution: Peas are cultivated in China (ranks first), former USSR, Ethiopia and USA. In India, it is cultivated in Uttar Pradesh, Madhya Pradesh, Bihar, Punjab and Haryana.

Soil and climate: Well-drained soil with pH range of 6.0–7.5 is ideal for peas cultivation. It is highly sensitive to water logging. It requires cool growing season with moderate temperature and it can be successfully grown in temperate and semi-arid zones.

Season and varieties: It is a rabi season crop in North India.

Field pea	: Second fortnight of October
Garden peas	: First fortnight of November
Table varieties	: Arkel, Bonnville. Early Badger, Early December
Filed pea varieties	: Type 163, PG 3, Aparna, Hans, Swarna Rekha

Field preparation: The land is prepared as a well pulverized seed bed.

Seed rate and spacing:

Pea type	Varieties	Seed rate (kg/ha)	Row spacing
Field peas	All	60–80	30 cm
Garden peas	Early maturing and dwarf	100–125	20 cm
Late maturing and tall	75–80	30 cm	

Weed management: Application of Fluchloralin at 0.75 kg a.i./ha or hand weeding twice is recommended.

Cropping systems: Peas are mixed with wheat, barley, oats, rape seed and mustard in north India. It is rotated after maize, paddy, cotton, jowar and bajra.

Yield: The green pods yield is 10–12.5 t/ha and 2–3 t/ha for field pea.

12. LENTIL (*Lens culinaris*)

It is an important rabi pulse and is one of the oldest and most nutritious pulse. Whole pulse is known as Malka masoor. It has the potential to cover the risk of rainfed farming. It is used as a cover crop to check soil erosion in dry land areas. It is eaten as dal. The split dal is deep orange (or) orange yellow in colour. It contains protein (25.0%), carbohydrate (60.0%) and fat (1.8%). It is rich in calcium, iron and niacin. Being a leguminous crop, it fixes atmospheric nitrogen and improves soil fertility.

Origin: Eastern Mediterranean consists of Asia Minor, Greece and Egypt.

Distribution: It is cultivated in India, Turkey, Syria, Pakistan, Spain, and Bangladesh. India ranks first in area and production, followed by Turkey. In India, it is mostly grown in central and eastern parts of India (Madhya Pradesh, Uttar Pradesh, Bihar and West Bengal).

Classification: There are two groups:

1. Small seeded group sub sp. *microspermae* (*masuri*)
2. Bold seeded group sub sp *macrospermae* (*malkamasur*)

Soil and climate: It requires cold climate and can be cultivated up to 3000 m above MSL. Lentil is not affected by rain at any stage. It can be raised with moisture conserved during monsoon period. It is a very hardy plant and it can tolerate frost and severe winter. It requires cold temperature during vegetative growth and warm temperature at the time of maturity. Optimum temperature for growth is 18–30°C. Lentil is cultivated in north India (light loams and alluvial soils), Madhya Pradesh and Maharashtra (well drained, moderately deep, light black soils) and Punjab (undulated lands). The crop can withstand moderate amount of alkalinity and acid soils are not suitable.

Varieties

<i>Pusa varieties</i>	<i>Punjab varieties</i>	<i>Uttar Pradesh varieties</i>
Pusa 1 (100–140 days)	L 912, LL 56 (150–160 days)	Type 8 (120–125 days)
Pusa 4 (130–140 days)		Type 36 (130–140 days)
Pusa 6 (130–135 days)		

Land preparation: Soil should be made friable.

Seed rate and sowing: For normal sown, the seed rate is 30–40 kg/ha and 50–60 kg/ha for late sown. Seed treatment with fungicide and bacterial culture may be given. Best time of sowing is second fortnight of October. Delayed sowing results in heavy yield reduction (after 15th November). Yield reduction can be minimized by closer spacing and higher seed rate.

Method of sowing

Line sowing	:	30 cm row spacing (behind country plough)
Broad casing	:	just like rice fallow pulses
Late sown condition	:	20 cm spacing
Depth of sowing	:	2–3 cm

Water management: The crop needs 1–2 irrigation *i.e.*, first irrigation on 40 DAS and second irrigation at flowering (or) pod formation.

Nutrient management: N at 20–25 kg/ha and P at 50–60 kg/ha is applied. Whenever it is cultivated after rice, 0.5% ZnSO₄ foliar spray may be given.

Weed management: Application of Fluchloralin at 0.75 kg a.i./ha as pre-planting spray (or) hand weeding twice at 30 DAS and 60 DAS is recommended.

Harvesting: When the plants dry up, pods mature and moisture reaches 12%, harvesting is done.

Yield: The yield varies from 1.8–2.0 t/ha.

15.6 OIL SEED CROPS

The production of oilseeds grew at the rate of 2.84% per year along with productivity growth of 1.95% during 1986–2004, and the area growth of 0.84%. The present productivity is just around 1 t/ha, which needs to be increased to at least 1.3–1.6 t by 2010 and 2015 respectively, if the country has to achieve self-sufficiency in edible oils. Annual oil seed production in the country is faced with high degree of

variation, as nearly 76% of the oil seed areas are rainfed. It is cultivated in Haryana, Madhya Pradesh, Rajasthan West Bengal, Rajasthan, Maharashtra, Gujarat etc. For the country as a whole, oil seeds production between 1985–86 and 2003–04 increased by 66.7% due to 19.8% increase in oilseeds area and 38.2% increase in productivity. It is possible to reach 33–35 m. ha under oilseeds by 2015, if efforts are made in all potential areas with appropriate policy back up along with scientific adjustments in cropping systems and patterns. The productivity during 2003–04 is 1067 kg/ha. In 2003–2004, the production is 252.88 m.t. and in 2004–05, it is 248.42 m.t.

Major oil seeds

1. *GROUNDNUT (Arachis hypogaea)*

A. Origin

There are two school of thoughts about its origin-one, it had originated in Africa and the other tracing its origin to Brazil in South America (De Gandolle, 1825). Its introduction in India is considered to be through Jesuit Fathers (Missionaries) who followed Vasco De Gama in the first half of the 16th century.

The production during 2003–04 was 81.82 m.t. with a productivity of 1364 kg/ha. But the production was 64.76 m.t. during 2004–05.

B. Climate and Soil

Groundnut is a tropical crop, which requires a long and warm growing season while high rainfall, drought and cold weathers are extremely detrimental for better crop growth. Normally it needs about 70–90°F temperature during its growing period with cold nights at maturity. It can be grown well in tracts, which receive an annual well distributed rainfall of 500–1250 mm. The best type of soil for groundnut cultivation is well drained, light coloured, loose, friable, sandy loam, well supplied with calcium and moderate amount of organic matter. Soils with poor drainage high acidity or alkalinity must be avoided for groundnut cultivation. A soil pH over 5.0 or below 8.5 is supposed to be an ideal for groundnut production. In Uttar Pradesh, it is grown in alluvial sandy to loam soil while in Madhya Pradesh, Maharashtra, Gujarat, Andhra Pradesh and Karnataka, the crop is taken in black cotton and red soils. Heavy clay is not fit for groundnut production because soil becomes very hard during drought, which restricts pod formation and development. Even peg penetration becomes difficult.

C. Land Preparation

For good germination and higher pod yields, it is essential to get a weed free well pulverized, open and aerated seed-bed for sowing. The field must be thoroughly leveled to avoid water logging in any part of the field. A required tilth may be obtained by ploughing twice with country plough or disc plough/mould board plough followed by two harrowings and planking. If the field is infested with white grubs, chemicals like Heptachlor or Chlordane should be drilled at 25 kg/ha before the final harrowing. To break hardpan, ploughing with chisel plough at 0.5 m interval is done once in 3 years.

D. Manuring

Groundnut, being a leguminous crop, does not require very high doses of nutrients. Organic manures like FYM or compost at 6.25 t under rainfed and 12.5 t/ha under irrigated conditions, if to be applied, should be spread and mixed well in the soil at least 15–20 days before sowing. In general, it needs about 10–20 kg N, 40 kg each of P_2O_5 and K_2O /ha under rain fed conditions while under irrigated conditions, an application of about 20–40 kg N, 40–90 kg P_2O_5 and 20–40 K_2O /ha is sufficient. It is always better to apply N in the form of ammonium sulphate/calcium ammonium nitrate, P as single super phosphate

and K as muriate of potash. In case of very light soils, the N should be applied in two splits *i.e.*, half at sowing and half (top dressing as band placed) 30 DAS or at the time of last intercultivation. It is observed that Andhra Pradesh soils are deficient in B and Mo whereas north Indian soils are deficient in S, Zn and Ca. These deficiencies may be corrected by application of 5 kg Borax, 1.0 kg Ammonium molybdate, 15–20 kg of Zinc sulphate and 200–500 kg of gypsum/ha. Of these, Borax and Ammonium molybdate should be applied as basal while gypsum should be band placed near roots 30 DAS. These nutrients should be applied in the zone of pod development as they are directly absorbed by the developing pods. To tide over surface crusting, application of lime at 2 t/ha along with FYM or coir pith at 12.5 t/ha is recommended. In Tamil Nadu, if the soil test is done, a blanket fertilizer recommendation of 10:10:45 kg of NPK for rainfed crop and 17:34:54 kg of NPK for irrigated crop is recommended.

E. Seed Quality

To ensure good stand, uniform maturity, high yield and better quality produce, one has to be careful about the seed quality. The seed must be pure, viable, uniform in size and free from the seed borne diseases. The seeds should not be broken or damaged by any means. It is better to use hand shelled kernels but if large area is to be sown, groundnut sheller may be used. The germination of the seed should be checked and the seed not having over 90 per cent germination should be selected for sowing. It is observed that the germination in case of bunch type is always higher (90–95 per cent) than the spreading type (85–90 per cent). To ensure the freedom of seed from seed borne diseases, the kernels must be treated with captan or Thiram (Slurry made by mixing 125 g Thiram/100 kg kernel in 500 ml of water). It is observed that some of spreading varieties have a dormancy of 60–75 days before they germinate. Therefore, in case of the freshly harvested kernels are to be used for sowing within the dormancy period, the kernels should be treated with some germination promoting hormones like GA etc.

Seed treatment: It is advised that, when groundnut is to be introduced in some new areas where it was never grown, the kernels should be treated with *Rhizobium* culture for better nodulation, growth and development of the crop. For 50 kg of kernels, prepare 10% solution of gum Arabic in water, add gur (Jaggary) to make a solution of 5%. When it is dissolved, add 2–3 packets (200 g each) of peat based culture, pour the groundnut kernels and agitate the content to make a slurry. When all the kernels have had an uniform coating of the slurry, spread them out on newspaper sheets in the shade. Reject the left over slurry after use and sow the seeds when they have dried completely. In Tamil Nadu, the seeds are treated with Trichoderma at 4 g/kg of seeds (or) with Thiram at 4 g/kg of seeds.

F. Sowing

(i) **Time of sowing:** In north India, groundnut is grown during kharif (April-July under irrigated conditions and between June 20 and July 31 under rain fed conditions). In Tamil Nadu, the crop is sown from May to July where as in Andhra Pradesh and Gujarat, it is sown between January and March. The season and varieties for Tamil Nadu conditions are given below:

Rain fed

Chittirai pattam (April–May)	-	VRI 2, 3, JL24, CO ₂ , TMV ₂
Early Adipattam (June–July)	-	TMV ₂ , VRI3, VRI4
Late Adipattam (July–Aug)	-	JL 24, VRI2
Aippasipattam (Oct)	-	JL24, VRI2.

Irrigated

Summer (April- July)	-	VRI2, VRI3, BSR1
Margazhi pattam (Dec-Jan)	-	VRI2, VRI3, BSR1.
Masi pattam (Feb-Mar)	-	VRI2, VRI3, BSR1, JL24

(ii) **Seed rate:** The seed rate depends upon boldness, spacing and germination percentage of seeds. On an average, the seed rate of spreading type comes to 60-70 kg/ha while for bunch type, it is about 85-90 kg/ha. In Tamil Nadu, the seed rate for irrigated crop is 125 kg of Kernels/ha and it is 140 kg of Kernels/ha for rainfed crop.

(iii) **Method of sowing:** It is sown either by dibbling the seeds behind the plough or by using a seed drill. In case of irrigated crop, it is better to prepare ridges and furrows and dibble the seeds on ridges. In case of rainfed light soils, the crop is sown in flat beds. Form 10 m²-20 m² beds depending upon the avail of water, slope and soil type. Bed former may also be engaged. The groundnut seeds should be sown at a depth of 5-8 cm in light soils and 4-6 cm in case of moderate to heavy soil types. To ensure a good and proper germination a light covering with soil is required over the seed. Sometimes rodents and crows are noticed to take away the seeds from the field, therefore, use of some repellants like pine tar and kerosene for seed treatment are recommended, but care should be taken to avoid any injury to the kernels.

(iv) **Spacing:** It varies according to irrigation facilities and type of seed. In bunch type and rainfed crop, the spacing of 20-30 × 8-10 cm is followed. The spacing for semi-spreading and spreading types with irrigation facilities is 30-40 cm × 10-15 cm and 50 cm × 15-20 cm respectively. The spacing for ground nut in Tamil Nadu is 30 × 10 cm.

G. Irrigation

Generally groundnut is grown as a rainfed crop during kharif season though its water requirement varies from 500-700 mm but if crop is caught in a long spell of drought, especially at the pod formation stage, supplemental irrigation is given. In case of irrigated crop, the frequency of irrigation depends upon soil texture and the interval between the irrigations ranges between 8-12 days. The critical stage for irrigation is flowering pegging and pod formation. Giving two irrigations during flowering, two irrigations during pegging and 2-3 irrigations during pod development stages is done. There should be sufficient moisture at the sowing time in the field, thus if the crop is to be sown before onset of monsoon the field should be given one light pre-sowing irrigation for better germination, followed by life irrigation on 4-5 DAS. The winter and summer crops are always grown under assured irrigation. The irrigation must be stopped about 20-25 days prior to maturity.

H. Weed Management

Weeds may cause reduction in the yield to the extent of 20-40% based on nature of weed infestations in the field. To kept the soil loose and friable and the field free from weeds, the crop should be given a hand weeding 20-25 DAS and one or two hoeing—the first at the time of weeding and second about a fortnight later. The intercultural operations should be stopped after the pegs have started going into the soil. The bunch and semi spreading types should be given a light earthing to facilitate the maximum penetration of the pegs into the soil. For weed control problem, application of TOK-E-25 or Lasso at 5 l of commercial material dissolved in 500 litres of water as pre-emergence soil spray within 2-3 DAS is done. In Tamil Nadu, pre sowing or pre emergence application of Fluchloralin at 2.0 litre/ha followed by one hand weeding on 35-45 DAS is recommended. If herbicides are not applied, two hand hoeing on 20 and 40 DAS is recommended.

I. Mixed Cropping

It is growing with several erect growing crops like bajra, arhar, castor, sesame, cotton, maize, sunflower etc. The number of groundnut rows between two rows of any of the said crops depends upon their inter-row spacing and type groundnut, *i.e.*, bunch, semi-spreading or spreading to be grown.

Gypsum application: Gypsum should be applied at 400 kg/ha on 40–45 DAS for intercropping and 40–70 DAS depending upon moisture. Hoeing and incorporating it is done, followed by earthing up. Gypsum encourages pod formation and better filling of up of the pods.

J. Use of Hormones

Use of hormone was not very much practical in the past but with the advancement of the production technology now application of certain hormones has become a common practice. Seeding the growth behaviour of the crop we find that groundnut usually suffers from two drawbacks—the first is that the crop being non-determinate keeps on flowering and production of pegs simultaneously until maturity and the second is that the pods start germinating at once after reaching physiological maturity, if they get water. As a result and effective pods germinate if there is rain or irrigation. Thus both the conditions lead to very poor yield and quality of the crop. Application of L-NAA in the form of planofix and Vaardhak at 20 ppm at the time of flowering is done to reduce the excessive vegetative growth and flowering period which ultimately increases the number of effective pods/plant, test weight and the yield/unit area. It has also been observed that their two applications at lower concentration are better than one application at higher concentration. The most ideal time for application is 40–80 DAS. Application of MH (Maleic hydrozide) near maturity results in inducing dormancy in the pods for about 20–30 days which checks the germination of matured pods even if they get water. However, the chemical being very expensive is not commonly applied.

K. Harvesting

Yellowing of leaves is the prominent symptom of maturity. The leaf yellowing is associated with leaf shedding (particularly, the older ones), development of proper colour of shell and a dark tint on the inner side of the shells. It is better to observe the crop duration. Usually the crop takes about 120–140 days time to mature depending upon the variety and the harvesting is done in the month of October–November accordingly. At maturity, the crop is badly damaged by crows, jackals, pigs etc. which need vigilance. After maturity, the bunch and semi-spreading types are generally harvested by hand pulling at an appropriate soil moisture, while the spreading types are harvested by digging out the plants with the help of khurpi, spade or by ploughing the field. The left out pods in the soil are collected by hand, later. The pulled out plants are stacked in a safe place for a few days to dry and are stripped afterwards. The stripped pods are cleaned nicely and dried to a safe moisture content of not more than 5% before they are stored because dampness will cause fermentation of pods and allow to develop the poisonous moulds like *Aspergillus flavus* in the kernel. These moulds lead to contamination with aflatoxin which create a health hazard to both human and cattle who consume the kernels. Ground strippers are also used for separating pods from the plant.

L. Yield

The pod yield is controlled by several factors like climate, soil and varietal potentiality. In general, the irrigated groundnut crop produces about 30–35 q pods/ha and rain fed about 15–20 q pods/ha. The yield of haulms is usually two to two and half times of pods' yield. The shelling percentage ranges between 70–75% and the kernels have on an average 45–50% oil in them.



Fig. 15.15 Groundnut stripper

M. Post Harvest Technology

Drying: Generally, moisture in pods is found to be around or excess of 40% (on wet basis) depending upon stage of maturity at harvest. The pods must be dried to 5-10% moisture for safe storage and for preventing molding and other forms of deterioration. It helps in maintenance of the desirable flavour, texture, germination and viability of kernels etc.

Storage: All the damaged or injured pods must be sorted out before they are stored. Well cleaned and dried pods to 5% moisture level should be stored after filling in gunny bags. The bags are stacked in a store room in tiers comprising not more than ten bags in each tier. The tiers must be staked on wooden planks in such a way that the air keeps on circulating to avoid damage from dampness, rate etc. The room should be inspected periodically and proper control measures of rats and pests should be taken. The store should be fumigated, if needed and made airtight. The groundnut should be stored in the form of pods rather than kernels but the broken and damaged pods must be taken out and discarded. Apart from this the undersized/underdeveloped and unfilled pods (pop-pods) should also be discarded because their presence reduces the market price.

2. SESAME (*Sesamum indicum*)

Sesame production in India during 2003–04 was 8.03 m.t. with a productivity 453 kg/ha, but during 2004–05, the production was 6.48 m.t. Sesame is mostly grown in rainfed areas receiving an annual rainfall of 500–700 mm but it cannot stand frost, continued rain or prolonged drought. The crop may be grown on a variety of soil types ranging from sandy loam to heavy black soils, with a pH ranging from 5.5 to 8.2. In north India, the crop is mostly grown during kharif and in some places during summer season, but in central parts of India, it is grown in kharif, rabi and summer. Kharif and semi-rabi crops are completely rain fed but summer crop is grown under assured irrigation for which it is sown in May/June, August-September and February–March respectively.

A. Varieties

<i>Andhra Pradesh</i>	:	Gowri (C. 1036), T 85
<i>Gujarat</i>	:	Mrug-1, Purva-1, Patan-64, Patan-65
<i>Madhya Pradesh</i>	:	G-5, T-4, G-35, N0-128, N-32
<i>Maharashtra</i>	:	D. 7-11-1, N. 58-2, N.128, T. 85 and Chanda-8.
<i>Orissa</i>	:	Vinayka, Kalika, Kanak
<i>Rajasthan</i>	:	Pratap (C-50), T. 13
<i>Uttar Pradesh</i>	:	T. 4, T. 10, T. 12, T. 13, T 22
<i>Bihar</i>	:	Kanke white, M-3-1, M-2-3, M-3-3.

Season and varieties for Tamil Nadu**Rain fed**

Adipattam (Jun-July)	–	CO 1, TMV 3, 5, VRI 1, 2
Karthigai pattam (October- November)	–	CO 1, TMV 3, 5, VRI 1, 2
Summer season (Masipattam) (February- March)	–	CO 1, TMV 3, 5, VRI 1, 2

Irrigated

Masi pattam (Feb-March)	–	TMV 3, TMV 4, VRI 2
Rice fallows	–	VRI 1

Characteristic features of some important varieties

Type-4: It matures in 100 days and yields 6–7 q/ha. It has reddish white flowers, seeds are white and have 52% oil.

Type-10: It matures in 80–90 days. Seeds are white and have 50–52% oil. It is a selection from Varanasi local.

Kalika: It is improved from Vinayak and recommended for kharif and zaid sowing. It may produce 8–9 q/ha during kharif and 13–14 q/ha during summer season.

Kanak: It is selection from Vinayak and T. 4 and has grey seeds. The variety is recommended for Orissa.

Kankie white: This has white seeds, matures in 120 days and can produce 4–6 q/ha. The oil content is 50%.

M-3-1: It is recommended for Bihar, it has black seeds, matures in 142–150 days and can produce 3–6 q seeds/ha.

Pratap: It is recommended for Rajasthan. This variety matures in 95–100 days and has white seeds and can produce 5–10 q/ha. The oil content is about 48%.

Rt-46: 75 days duration, white seeded, resistant to diseases. It produces about 6 q/ha and is found suitable for Jammu and Kashmir, Himachal Pradesh, Punjab, Haryana, Rajasthan and western Uttar Pradesh.

Improved Selection 5: 80–85 days duration, seeds are reddish brown in colour, it is resistant to stem rot, bacterial leaf blight, tolerant to leaf spot, phyllody and powdery mildew. It produces 6–7 q/ha and is recommended for West Bengal, Bihar, Orissa, Madhya Pradesh and western Uttar Pradesh.

B. Field Preparation

The field is ploughed 3–5 times with country plough or thrice with mould board plough. To break hard

pan, ploughing with chisel plough at 0.5 m depth is done. For irrigated gingelly, beds of 10 m² or 20 m² are formed depending upon the water availability. In rice fallows, the field is ploughed once with optimum moisture and seed is sown immediately and covered with one more ploughing. Application of FYM/compost/composted coir pith at 12.5 t/ha as basal is recommended. The blanket fertilizer recommendation for Tamil Nadu is as follows:

Rainfed crop	– 23: 13: 13/17: 13: 13 + 3 packets of Azospirillum
Irrigated crop	– 35: 23: 23/21: 23: 23 + 3 packets of Azospirillum

Full dose of NPK should be applied basally and 5 kg of manganese sulphate/ha is added. Two sprays of 1% DAP should be given at the time of first flowering and 10 days after first spray.

C. Seed Rate

The seed rate varies from 3–5 kg/ha which is mixed with sand (four times volume of dry seed) for proper distribution and drilled to 3 cm depth in lines at a row to row spacing of 25–35 cm during summer but during kharif season a spacing of 35–45 cm × 12–15 cm is followed. In Tamil Nadu, the spacing for rice fallows is 30 × 30 cm in rice fallow and seeds are broadcasted and thinned to maintain 11 plants/m².

D. Seed Treatment

The seeds are treated with Captan or Thiram at 3 g/kg of seed to control fungal diseases. In Tamil Nadu, the seeds are treated with Trichoderma at 4 g/kg of seeds.

E. After Cultivation

Thinning is done on 15 DAS by 15 cm spacing and 30 DAS by 30 cm spacing. Hand weeding on 20 DAS is done or a pre-emergence application of Lasso at 3 l/ha is recommended. In Tamil Nadu, application of Alachor at 1.25 kg a.i./ha on 20 DAS is recommended and irrigate immediately or weed and hoe on 15 and 35 DAS.

F. Water Management

Normally the crop is grown as rainfed during kharif but the rabi and summer crop need irrigation. The crop should be irrigated twice in rabi season (at flowering and grain filling) whereas summer crop needs 3 irrigations. In Tamil Nadu, irrigation at sowing, life irrigation on 7 DAS (depending on the soil and climatic condition), pre-flowering irrigation (25 days) (one at flowering and 1–2 at pod setting) is recommended.

G. Harvest

The physiological maturity symptoms are; 25% of bottom leaves from bottom are shed, the top leaves, stem and capsules colour will turn yellow; before the bottom capsules turn brown and observe the crop duration and examine 10th capsule from the bottom by opening. The physiologically matured crop having leaves still green should be harvested by cutting the plants with sickles, which are carried to threshing floor and stacked for a week (one over the other in a circle with the stems pointing out and the top position positing inside) by covering the top with straw and cure it for 3 days. Later, the plants are well shaken by holding upside down (75% of seeds will fall off) or by beating with stick to take out the seeds. The plants are dried again for one more day and again the plants are shaken. The seeds are winnowed, dried in sun for 3 days and stored in gunnies.

H. Plant Protection

To control leaf-eating caterpillar and gall-fly, spraying of Carbaryl 0.2% or Endosulfan (0.5 kg a.i./ha) on 40 and 60 DAS. Three sprayings of 100 ppm Agrimycin at 15 days interval control the bacterial leaf spot disease. Spraying of 0.05% of any Phosphomidon or Dimethioate kills the insect vectors responsible for spread of phyllody and leaf-curl in sesamum.

I. Yield

A Good kharif crop gives about 200–500 kg seed yield/ha while rabi and summer crop yield about 300–600 kg seed/ha.

3. SUNFLOWER (*Helianthus annuus L.*)

Sunflower production in India during 2003–04, was 991000 t with a productivity of 496 kg/ha, but during 2004–05, the production was 12.41 m.t. Sunflower has three sub-species viz., *H. annuus* var. *macrocarpus* (DC), *H. annuus* var. *lenticularis* (Dough) and *H. annuus* var. *jaegeri* (Heiser) which are cultivated ones. The wild species are *H. anomalus*, *H. orgophyllus*, *H. bolanderi*, *H. deblis* sp. *Bedlis*, *H. deserticola*, *H. neglectus*, *H. riveus* sp. *Conesceus*, *H. paradoxus*, *H. periolasis*, *H. praccex* sp. (*hirtus*, *praecox*, *runyonii*), *H. mutalli* (All having no. = 17 chromosomes) and *H. tuberosus* (51 chromosomes). Sunflower cultivars vary greatly in plant height, time of maturity, number, diameter and colour of heads; size, shape, colour, oil and husk content of seeds and suitability for different climates. Thus, the cultivars may be divided into following types:

1. **Giant types:** 180–420 cm tall, late maturing, heads 30–35 cm in diameter, seeds large, white or grey with lower oil content, variety–‘Mammoth Russian’.
2. **Semi Dwarf types:** 130–180 cm tall, early maturing, heads 18–24 cm in diameter; seeds smaller, black/grey, higher oil content, variety–‘Pole Star’, Jupiter.
3. **Dwarf types:** 60–130 cm tall, early maturing, heads 12–17 cm in diameter, seeds small, highest oil content, variety–‘advance’, ‘sunrise’ etc.

A. Varietal Improvement

In India, heterosis breeding was initiated in early seventies over better parents for yield and yield components involving CMS lines and restorers Hybrid 1 (BSH 1) and BSH 2 evolved at Bangalore showed yield stability under various agro climatic zones of the country. Subsequently 1980 BSH 1 was released for commercial cultivation. The hybrids have following advantage over open pollinated varieties:

- Hybrids have high yield potential and are responsive to higher inputs.
- They are superior in their seed filling ability and are comparatively more self fertile.
- They are more tolerant to diseases and pests and have higher drought tolerance.

B. Seed Dormancy and Viability

The sunflower seeds (achenes) remain dormant up to 40–45 days of harvesting however, the dehusked seeds may germinate from 10th day after harvest. Exogenous application of ethrel, benzyl adevine and GA promotes germination of achenes. Pre-soaking of dormant seeds with ethrel solution (25 ppm) equivalent to 40% by volume of seeds has been found to be optimum. The soaking period may vary from 6 to 24 hrs. The achenes should be dried in shade and then may be sown directly. Usually sunflower seeds remain viable for 10–12 months but under hot humid conditions, the seeds lose viabil-

ity quickly. At 50–85% relative humidity, seeds lose viability even under high humidity conditions. Short-term seed hardening treatment given to 6 month old seeds extends viability up to 10 months.

C. Advantages of Sunflower Cultivation

Being a short duration, it can be well suited as catch crop. It is a drought, frost and salt tolerant crop. There is very slow degeneration in seed quality hence the same seed can be sowed for sowing up to 4–5 years. Being thermo and photo insensitive, it can be grown any time in the age, year, in any part of the country and under any type of cropping system. Sunflower is a useful crop for apiculture (bee keeping) as it attracts the bees and provides them nectar. The rainy season sunflower is mostly grown as rain fed crop in which few crops like groundnut (2:6), ragi (2:5), cowpea or black gram (2:3) may be successfully intercropped.

D. Season

Sunflower, being photo and thermo non-sensitive, can be grown thrice in a year *i.e.*, rabi (October/November), zaid (January/February) and kharif (June/July). The season and varieties for Tamil Nadu condition are given below:

Rain fed

Adipattam (June-July)	-	K ₁ , K ₂ , CO ₁ , CO ₂ , EC 68415
Karthigai pattam (October–November)	-	K ₁ , K ₂ , CO ₁ , CO ₂ , Modern

Irrigated

April–May	-	K ₁ , K ₂ , CO ₁ , CO ₂ , EC 68415, Modern
December - January	-	K ₁ , K ₂ , CO ₁ , CO ₂ , EC 68415, Modern

E. Seed Treatment

The seeds are treated with Captan or Dithane or Thiram or Brasicol @ 2 g/kg of seed before sowing.

F. Field Preparation

Generally sunflower is grown as a rain fed crop in kharif, hence to make use of rain water, it is necessary to plough the land once by a mould-board plough followed by harrowing soon after the onset of the rains. The crop prefers deep fertile soil adequately supplied with moisture without producing water logged conditions that adversely affects the germination of seed. In Tamil Nadu, the sunflower is raised in ridges and furrows of 6 m long and the seeds are placed at 3 cm depth (two seeds per hole) along the furrows in which the fertilizer mixture is placed and the soil is covered.

G. Sowing and Seed Rate

Seeds having over 70% germination and 80 g test weight (of 1,000 seeds) would be sown at 8–10 kg/ha rate in spacing of 45–60 cm × 20–25 cm. In Tamil Nadu, the seed rate for varieties is 15 kg/ha and for CO 1, it is 30 kg/ha. In order to have a stand of 80,000 healthy plants/ha thinning or gap filling is required during early stage of crop growth.

H. Manuring

After leveling the land, fertilizer @60:40:20 kg/ha of NPK respectively for low fertility and 40:30:20 kg/ha of NPK respectively for high fertility soils should be applied and mixed properly with the soil. The IARI however, recommends 40:60:20 kg/ha NPK respectively. To increase the efficiency of nitrogen, 60% of nitrogen may be applied as basal and the remaining top dressed on 40 DAS. Increase in

yield and oil content have been reported by application of gypsum and sulphur especially in saline and alkaline soils. In Tamil Nadu, the following is the manuring schedule:

- Application of 12.5 t/ha of FYM or compost or composted coir pith evenly on the field before the last ploughing.
- Basal application of 40:20:20 kg NPK/ha for both irrigated and rain fed crops.
- Soil application of Azospirillum (10 packet -2000 g/ha) with 25 kg FYM or soil after sowing.
- Application of micronutrient at 12.5 kg/ha with enough sand to make a total quantity of 50 kg/ha on the furrows.

I. Weed Management

The crop should be kept weed free upto 45 days of sowing. Mechanical weeding twice at 20–25 and at 30–35 DAS are recommended for effective control of weeds. In labour scarcity areas, pre-emergence application of TOK-E-25 @ 1.5–2 kg a.i./ha or Prometryne @ 1.0 kg a.i./ha or Alachlor @ 1.5 kg a.i./ha may be done for economical and efficient control of weeds. In Tamil Nadu, application of Fluchloralin at 2.0 l/ha or pendimethalin at 2.5 lit/ha as pre-emergence spray followed by one hand weeding on 30–35 DAS is recommended.

J. Irrigation

The crop being drought resistant, may very well be grown under rain fed conditions. However, under irrigated conditions, one or two irrigations are required to increase the yield, although germination, flowering and dough stages are critical for irrigation. In Tamil Nadu, Irrigation is given immediately after sowing, followed by an irrigation on 4th–5th DAS and later at intervals of 7–8 days.

K. Plant Protection

The crop does not have serious insect-pest and disease problems. To control leaf caterpillars, leaf weevils, Heliothis and thrips, spraying Endosulfan (35 EC) or phosalone (35 EC) at 1000 ml/ha is recommended. The attack of grass hoppers at seedling stage and green bug at flowering stage can be controlled by dusting 10% BHC @ 30 kg/ha. Spraying Mancozeb 1 kg/ha for the control of alternaria leaf spot and spot drenching of carbendazium at 5 g/10 lit. of water for the control of charcoal rot is recommended. Sunflower is essentially a cross-pollinated crop. So, selection of suitable insecticide that is not harmful to pollination may be selected. Birds are a menace during seed formation stage and constant vigilance to scare them away is necessary.

L. Hand-pollination

Sunflower is a self-incompatible and depends on insects (mainly bees) for cross-pollination and seed-set, therefore, it is essential that adequate pollinators are present in the field, for pollen movement and seed-set. Otherwise the heads bear chaffy and partially filled seeds resulting into drastic reduction in yield and quality of the produce. Keeping bee hives at 5/ha in the field increases crop yield. Hand-pollination gives an increase in the crop yield to the extent of 18–25%. Hand-pollination could be done by gentle rubbing of the sunflower heads with palm or with soft muslin clothes during flowing period between 7 and 11 am on alternate days for about two weeks.

M. Harvesting

At maturity, the back of the floral heads and outer bracts turn yellow and then to brown colour respectively. The heads (capitula) harvested from the plants are dried for 3 days by spreading the heads in thin layer and turning them once in 3 hours and after the drying, threshing and cleaning is done to separate

the seeds. Seeds when harvested at 8–10% moisture level, have better keeping quality and higher oil content. The stalks may be used as fuel or for making high quality compost. One ha should yield 20–25 q sunflower seed. The seeds should be bagged at 6% moisture level for better keeping quality and germination. The oil must be extracted within 90 days of harvesting, otherwise it becomes bitter in taste especially when stored under damp conditions. Such seeds also lose their viability.

N. Problems in Growing Sunflower

- Greater menace of the birds especially of crows and parrots.
- Poor filling of seeds especially of disc florets.
- Unavailability of ideo-types and their superior seeds.
- Poor viability and lesser keeping quality of seeds.
- Poor market and acceptability of raw and fresh oil by the customers.
- Oil becomes bitter if not extracted within 90 days of harvesting.
- Plant protection (chemicals cannot be used as they kill the pollinators).
- Rains at maturity destroy the seed quality.

4. RAPE AND MUSTARD (*Brassica Sp.*)

Rape seed and mustard production in India during 2003–04 was 61.98 m.t. with productivity of 1151 kg/ha, but during 2003–04, the production was 75.39 m.t.

A. Climate and Soil

In India, rape and mustard is grown during winter season and it is observed that the crop needs about 18°C–25°C temperature, low humidity, practically no rain especially at the time of flowering. Rainfall, high humidity practically no rain especially at the time of flowering. Rainfall, high humidity and cloudy weather are not good for the crop during winter as it invites aphids and the crop gets spoiled completely. However, under rain fed conditions, one to two pre-flowering rains help in boosting the grain yield. Excessive cold and frost are harmful to the crop.

Generally the rape and mustards thrive best in medium or heavy loam soils. Though the crop is grown during winter seasons and there is very little chance of water logging but still due to heavy winter rains, the water may get accumulated and cause a temporary water logging. Very light soils usually cause a serious moisture stress and a poor crop growth is observed. Saline and alkaline soils are often not fit for the crop though it has good tolerance to such conditions.

B. Preparation of Land

It requires a fine, firm, moist seedbed so that a reliable moisture supply is assured for germinating seeds and young seedlings. For this, the field should be given one pre-sowing irrigation if there is less moisture in the field. The field should be given a deep ploughing soon after the kharif crop is harvested in middle of September. Thereafter, it may be ploughed for 3–4 times with desi plough and planking after each ploughing. The crop and weed stubbles along with established weeds should be picked up and thrown out of the field. In dry land areas where pre-sowing irrigation is not possible, the seed may be spread in damp place at night and next morning it should be sown. It increases the germination percentage of the seeds.

C. Time of Sowing

Sowing time is very important as the attack of aphids and the extent of damage can be reduced considerably by sowing the crop earlier or before middle of November. Toria must be sown between mid and

last week of September as the crop suffers badly from cold if sown late and the crop duration is increased without any additional yield due to slow growth that occurs due to lower temperature.

D. Seed Rate

A pure crop of mustard and rape seed needs about 6–7.5 kg/ha and toria needs 4–5 kg/ha, while mixed or intercrop of mustard requires about 2.5–3 kg seed/ha however, seed rate in case of mixed crop depends on its proportionate area to the main crop. The depth of seeding should not exceed 3 cm and the seeds are treated with thiram or captan @ 2.5 g/kg before sowing.

E. Method of Sowing

Line sowing is better than broadcasting, although broadcasting in case of high moisture conditions is common especially for 'toria' crop. Thus, it may be sown in shallow furrows behind desi plough or through seed drill or 'mala basa'.

F. Spacing

A spacing of 40–45 cm × 15 cm is recommended for rai and lotani sarson but 30 cm × 10–15 cm is recommended for yellow sarson and tora brown sarson. Sowing mustard in parallel rows 150–200 cm apart alternating with the main crop is recommended as a mixed crop with wheat. However, broadcasting of mixed seed is still in practice but it gives a poor seed yield.

G. Manuring

It is grown with nominal use or no use of fertilizers under rainfed condition. It is better that the soil of the selected field should be analyzed and application be made accordingly. If it is not done, application of only basal dose of 50–60 kg N/ha is sufficient for the rainfed crop. Indian mustard varieties of *B. napus* and *B. juncea* have a very short growing season and, therefore, their N requirement is very low, however, the mustard, sarson have shown better response up to 100–150 kg N/ha. It is advisable to apply about half at sowing time and rest at about 30 days after sowing, when thinning, weeding and first irrigation are over. A dose 60–100 kg N, 40–60 kg P₂O₅ and 40 kg K₂O per hectare may be recommended for long duration varieties. Regarding the mode of application it has been found that half of nitrogen with entire dose of phosphate and potash should be basal placed about 5–7 cm below the seed or by the side of the seed and remaining half of the nitrogen should be top-dressed about 30–35 DAS, while for 'toria' or short duration varieties 40–60 kg N, 20–30 kg P₂O₅ and 20 kg K₂O/ha has been found to be good dose which should be basal placed.

Variety	Nutrients in kg/ha			Method of application
	N	P	K	
Early Torai/Lahi	30–50	25	–	All basal
Mustard/Sarson(irrigated)	80–150	60	–	Half basal + half top-dressing at 30–35 DAS
Mustard/Sarson (Rain fed)	40–60	25	20	All basal placed
Taramire (Rain fed)	30–40	20	–	All basal

In general, the following doses are found to be optimum:

Rain fed: An amount of 40 kg/ha N along with 15 kg of P and K both for all rapeseed and mustard crops.

Irrigated: An amount of 40, 60 and 80 kg/ha N are considered optimum for 'toria', 'sarson' and

‘raya’ respectively, however, for taramira, 20 kg N/ha is found to be the best dose. Phosphate and potash have not given any positive response; hence they are not needed until the soil is deficient in them.

H. Water Management

Mustard requires about 310–400 mm of water which should be provided by giving two irrigations—first at flowering/branching stage and second at pod (siliqua) formation stage (first at 30 DAS and second at 60–65 DAS) in a crop of 110–120 days duration.

I. Weed Management

Manual weeding once about 25–30 DAS is recommended. Orabanche may be controlled by hand pulling and growing mustard after 2–3 years.

J. Plant Protection

Application of Dithane M-45 at 1.5 kg/ha or 2–3 applications of Bordeaux mixture is done to control alternaria blight and rust. Aphids may be controlled by spraying of Methyl Demeton. Aldrin/Hep-tachlor/Chlordane @ 25kg/ha controls cutworms and BHC 25 kg/ha controls sawfly.

K. Harvesting

The crop should be harvested as the pods turn to yellow colour. ‘Torja’ takes about 75–90 days and ‘Rai’ needs 110–180 days for maturity. Yellow sarson needs 130–160 days and Brown sarson needs 105–145 days. The crop is harvested with sickles and the threshing is done by beating the pods with wooden sticks or by trampling the plants by bullocks. The winnowing is done with the help of natural air current but the wind velocity should not be very high as the seeds, being very small, are blown with the air.

L. Yield

<i>Toria</i>	: Average of 5 Q/ha and highest of 8–10 Q/ha.
Yellow mustard	: Average of 10–12 Q/ha and highest of 30 Q/ha
Rai	: Average of 12–15 Q/ha and highest of 25–35 Q/ha.

15.7 OIL SEEDS—MINOR

1. CASTOR (*Ricinus communis* L.)

Castor contains 35–58% oil. The oil acts as the best lubricant for high speed engines, aeroplanes, manufacturing soaps, transparent papers, printing-inks, varnishes, linoleum and plasticizers etc. Its green leaves are fed to eri silkworms for producing eri silk. Castor occupies 4.4. lakh ha and produces about 1.4 lakh t of seed in India. Its production in India during 2003–04 was 8.01 m.t with productivity of 1094 kg/ha. The main castor producing states include Andhra Pradesh (67.2% area), Gujarat (12.7%), Karnataka (7.1%) and Orissa (5.8%) while rest 10% area is shared by other states.

A. Origin

Believed to be originated in Eastern Africa, probably in Ethiopia.

B. Season and Varieties

The crop is sown during June/July. In Tamil Nadu, it is grown as Rainfed (June- July) crop. It is cultivated as a border crop under garden land conditions (TMV 4). In intercropping, one row of castor for every six rows of groundnut is raised. In case of late receipt of monsoon, black gram + castor at 6:1

ratio is recommended. The castor varieties cultivated in different states are given below:

Andhra Pradesh	-	HC-6, HC-8, Aruna, Bhagya, Sowbhagya
Bihar	-	E.B. 16 A
Gujarat	-	GCH-3, J-1, GAUC-1, GAUCH-1
Haryana	-	Punjab Castor No.1
Karnataka	-	Rosy, MC-1
Tamil Nadu	-	TMV-1, TMV-2, TMV-3, TMV-5, SA-1, SA-2
Uttar Pradesh	-	T-3, Tarai-4, Kalpi-6
West Bengal	-	B-1

C. Sowing and Seed Rate

The seed rate is about 8–10 kg seed/ha and the seeds are treated with thiram @ 3 g/kg. The seeds are soaked in water for 20 hours before sowing. It is sown in furrow (drilling) or dibbled at 90–120 cm × 45–60 cm spacing. The seeds are placed at a depth of 4–6 cm and one seed in each hole. The spacing adopted for Tamil Nadu varieties is given below:

<i>Varieties</i>	<i>Spacing</i>
Long duration SA1	90 × 90 cm
Short duration SA2	60 × 45 cm
TMV4, TMV5	60 × 30 CM

D. Manuring

In general, application of 40:40:20 kg of NPK is recommended. In Tamil Nadu, application of 12.5 t/ha of FYM or compost before last ploughing and NPK at 30:12:12 kg/ha is followed.

E. Weed Management

Hoing and hand weeding on 20 DAS and 40 DAS is recommended. Weeds should be taken out before earthing the crop.

F. Plant Protection

To control semilooper and other pests in castor, application of Endosulfan 4D at 25kg/ha or neem seed kernel extract at 3% or neem seed oil at 2% is recommended.

G. Harvesting

The crop requires 150–180 days to mature and produces around 400–950 kg seeds/ha depending upon variety and production technology. At maturity, one or more capsules show signs of drying. The matured racemes are cut without damaging the secondaries and the capsules are dried in the sun without heaping it in the shade. Castor Sheller is used to separate the seeds or beating the dried capsule with wooden planks is done. Then the seeds are winnowed and cleaned.

2. SAFFLOWER (*Carthamus tinctorius L.*)

Safflower is grown for seed to extract oil or to be eaten after roasting. It contains 24-36% oil and is used for culinary purposes or for making soap. In India, it occupies about 0.59 m.ha and produces about 0.13 m.t. The productivity during 2003–04 was 367 kg/ha. Around 98% of the total cropped area lies in Maharashtra (64.4%), Karnataka (26.0%) and Andhra Pradesh (8.0%) while about 2% area is in Uttar

Pradesh, Madhya Pradesh, and part of Bihar. Safflower is grown mixed with wheat barley, gram and rabi jowar (after every 9–12 rows of main crop). It acts as guard crop, as it protects main crop against cattle trespass. Sometimes, it is grown as a pure crop in marginally fertile soils. The crop is sown in September/October by using 5 and 12 kg seeds/ha under mixed crop or pure respectively at 45 cm spacing between the rows if grown as pure crop. A good crop can be raised by applying 20–40 kg N/ha. Crop needs topping when plants have developed apical flower to promote branching, flowering and seed yield. It takes about 120–150 days to mature and produces 400–500 kg seed/ha when taken as a pure crop where as 100–150 kg/ha when grown mixed.

A. Origin

Originated in India, Afghanistan and Ethiopia (Vavilov) or Arabia (Decandole).

B. Varieties

Karnataka	-	A-1, A-300
Madhyar Pradesh	-	No. 7
Maharashtra	-	N. 62-8, Nag. 7, Tara
Tamil Nadu	-	K 1
Andhra Pradesh	-	Manjira (C-438)

3. LINSEED (*Linum usitatissimum*)

In India, the linseed production was 211,000 t with a productivity of 403 kg/ha.

A. Climate

It is grown during rabi season in India. The oil seed crop needs about 25–30°C during germination and about 15–20°C during seed formation but the fibre crop (flax) requires still lower temperature and high humidity. It is fairly resistant to drought and grows well in areas receiving an annual rainfall of about 450–750 mm. High rainfall and cloudy weather during growing period is very harmful for the crop. It requires high temperature, low moisture and fairly dry weather during its maturity.

B. Varieties

(A) Improved varieties:

Uttar Pradesh	-	Neelam, Hira, Mukta, T 397 and K-2
Punjab & Haryana	-	LC-185, K-2, Himalini
Madhya Pradesh	-	JLS(J)-1, Jawahar-17, Jawahar-552, Jawahar-7, Jawahar-18, T 397
Bihar	-	T397, Mukta
Rajasthan	-	T 397, Himalini, Chambal
Himachal Pradesh	-	Himalini, K-2, LC-185

(B) Characteristic features of the improved varieties

K-2: It is resistant to rust and powdery mildew. It matures in 140–170 days and produces 10–12 q/ha. The variety is suited to rainfed conditions.

L.C.54: It is resistant to rust, wilt and powdery mildew. It matures in 155–160 days and the crop produces 12–15 q/ha. It needs irrigation.

Himalini: The variety is resistant to all the diseases. It matures in 150–175 days and produces 12–15 q/ha.

Jawahar-7: It is resistant to rust but susceptible to wilt and can be grown rain fed. It matures in 115–125 days, bears blue flowers and produces 8-10 q seeds/ha.

Jawahar-7: It is resistant to rust but susceptible to wilt. It matures in 128 days, and produces 7–8 q/ha. It can be grown as rain fed crop.

Chambal: It is moderately tolerant to rust, wilt and powdery mildew. It may be grown as rain fed crop. It matures in 130 days and produces 8–9 q/ha.

Neelam: It is resistant to rust and wilt diseases. It matures within 125–150 days and produces 15–20 q/ha. The oil content is 43%. It is well adapted in Uttar Pradesh under both irrigated and rain fed.

Mukta: It is recommended for Uttar Pradesh. It matures within 130 days and produces 15–18 q/ha. The oil content is 45%.

Hira: It is resistant to rust and wilt diseases. It matures in 135–140 days and produces 15–18 q/ha. The seeds contain about 45% oil.

T-397: It is fairly resistant to rust but moderately resistant to wilt. It matures in 145 days and produces 12–18 q/ha. The seeds contain 43% oil.

LC-185: It is resistant to wilt, rust and also tolerant to frost. It matures in 170 days and produces 10–18 q/ha. The oil content is 46% oil.

C. Soil and Land Preparation

It may be grown on a variety of soil types, however, deep cotton soils of central India and alluvial loam soils of north India are highly preferred. The soil must be well drained and nearly free from soluble salts, though it may tolerate moderate acidity and salinity. It needs a weed free and fine textured seed bed. Termites and cutworms usually attack the crop, therefore, Aldrin or Chlordane 5% dust should be mixed in the soil at 25–30 kg/ha at the time of last ploughing.

D. Seed and Sowing

In rain fed areas, the crop is sown earlier in last week of September or mid of October when the rains have stopped so that best use of residual moisture of rains be made but in case of irrigated areas, the crop may be sown little later in October-November by giving one light pre-sowing irrigation. Broadcasting of the seeds should be avoided and it should be sown in lines either behind the country plough in shallow furrows or by the seed drill. In Bihar and eastern parts of Uttar Pradesh, the linseed is broadcasted in standing rice crop as relay crop during September-October. (This system of sowing is called as paira or Utera cropping) which occupies nearly 25% of total area under linseed crop but in case of mixed cropping of linseed with wheat, gram and barley, it is sown in rows after every few lines of aforesaid crops. In case of pure crop of linseed, a row to row spacing of 20–30 cm is given and a seed rate of 20–30 kg/ha in case of line sowing and 35–40 kg/ha in case of broadcasting is required.

E. Seed Treatment

The seeds are treated with Bavistin/Topsin @ 2 g/kg seed or Agrosan GN or Thiram @ 3g/kg of seed before sowing.

F. Fertilizer Application

Normally, the rainfed crop is grown under unfertilized condition of residual fertility or under very poor fertilizer doses. But, in case of rain fed crop, the placement of 20–30 kg each of N and P₂O₅ but in case of irrigated crop, a dose of 30–40 kg of each of N and P₂O₅ per ha is recommended. When linseed is to be sown as relay cropping in standing rice crop, top dressing with only 10–15 kg N/ha would be enough. In irrigated condition, top dressing with half of the required N is more beneficial.

G. Weed Control

The crop suffers from a very severe weed competition up to 25 DAS. Two hand weedings—first after 21 DAS and second after 35–40 DAS are recommended.

H. Irrigation

Under irrigated conditions the crop should be given two light irrigations—first 35 DAS and second 65 DAS.

I. Plant Protection

Gall midge is controlled by spraying 0.3 % Metasystox or Dimecron or Rogor. The spraying should be done two-three times at 10 days interval starting from appearance of the insect in the crop. To manage diseases like wilt and rust, the resistant varieties like R-552, K-2, LC-54, LC-185 as wilt resistant and R-7, R-17, R-552, LC-54, K-2, LC-185 as rust resistant should be selected and grown. Early sowing of short duration varieties and seed-treatment can reduce the incidence of insect-pest and diseases. The powdery mildew and alternaria blight may be controlled by spraying of sulphur (0.3%) or Karathane (0.2%) or aulfex (0.2%).

J. Harvesting, Yield and Storage

The crop should be harvested at red ripe stage but when fibre and grains both are to be taken from the same crop then harvesting at physiological maturity or pod maturity should be done when the plants are little green. The crop is traditionally harvested by sickles and threshing is done by beating the plants with wooden mallets or by trampling them under bullock's feet. It usually produces about 4–5 q/ha under mixed cropping but the yield is about 10–12 q/ha when grown as pure crop. The seeds contain 36–42% oil and they may be stored at 10–12% moisture.

4. NIGER (*Guizotia abyssinica* L.f. Cass)

The crop is grown to yield oil ranging between 37 and 43%. The oil is used for culinary purposes and manufacturing paints, soft soaps etc. In India, it is grown in about 4.8 lakh ha which produces about 1.11 lakh t of seeds. The productivity during 2003–04 was 253 kg/ha. It is grown in Madhya Pradesh, Bihar, Maharashtra, Orissa and Tamil Nadu and partly in Uttar Pradesh also. The Niger is a kharif crop, which should be grown at 30 cm × 10–15 cm. The seed rate is about 7–8 kg seed/ha. It requires about 20 kg of both N and P₂O₅/ha. Niger matures in November/December and produces about 100–200 kg seed/ha under mixed cropping and 500–700 kg/ha when grown as a pure crop.

A. Origin

Tropical Africa probably in Ethiopia.

B. Varieties

Karnataka	–	No. 16, No. 24
Madhya Pradesh	–	Ootacamund No. 5, N. 87
Maharashtra	–	Niger B
Orissa	–	GA.2, GA.10

5. OIL PALM (*Elaeis guinensis*)**A. Climate**

Oil palm is considered as a humid tropical crop. It requires evenly distributed annual rainfall of 2000

mm without a defined dry season, since it is continuously growing and yielding all through the year. Though the crop can with stand 3–4 months of dry period, continued moisture stress affects the yield adversely unless augmented with copious irrigation. Best oil palm yields are obtained in places where a maximum average temperature of 29–33°C and minimum average temperature of 22–24°C. Higher diurnal temperature variation causes floral abortion in regions with a dry season. Constant sunlight of at least 5 hrs/day is required for better oil palm yield and it grows well on moist, deep and well drained medium textured soils rich in humus content.

B. Nursery

Potting mixture is made by mixing topsoil, sand and well decomposed cattle manure in equal proportions. Poly bags of 500 gauge and 40 × 40 cm size preferably black colour are used for raising primary nurseries. A healthy germinated sprout is placed at the center at 2.5 cm depth. On the lower half of the bag, perforations are made at an interval of 7.5 cm for drainage. It is important to provide shade until seedling attains two leaf stage. The water requirement for different stages of growth of seedling is as follows.

0–2	months at 4 mm/day
2–4	months at 5 mm/day
4–6	months at 7 mm/day
6–8	months at 10 mm/day

A well developed tenera seedling with a height of 1–1.3 m from base and more than 13 functional leaves of 12–14 months of age is selected, since this seedling is found to maintain higher leaf production, bear earlier, produce heavy bunches, give higher fruit/bunch ratio and a higher oil to mesocarp in the first year of harvest.

C. Transplanting

Most suitable time for transplanting seedling in main field in India is with the onset of monsoon. Optimum plant population recommended is 140 seedlings/ha with a spacing 9 m × 9 m × 9 m in Triangular system of planting. Pits of 60 cm are taken prior to planting and filled with surrounding top soil and allowed to settle. In the refilled and root zone soil, a depression sufficient to cover the ball of earth is made at the time of planting. Rock phosphate is applied at 200 g/pit. N and K are usually applied 4–6 weeks after planting. Replanting is carried out during the onset of next monsoon. These palms are to be given special care so that they can catch up with the rest of the plantation.

D. Ablation

The bunches produced initially will be very small and have low oil content. Removal of such inflorescence is called ablation or castration. Ablation is done at monthly interval by pulling out the young inflorescence using gloves or with the help of devices such as narrow bladed chisels. Ablation improves drought resistance capacity of young palms by improving shoot and root growth especially in low production areas where dry condition exist.

E. Pruning of Leaves

In oil palm, two leaves are produced per month. Therefore, it becomes necessary to prune excess leaves so as to gain access to bunches for harvest. Severe priming will adversely affect both growth and yield of palm, cause abortion of female flowers and also reduce the size of the leaves. Pruning is carried out in India using chisels, preferably at the end of the rainy season and low crop season when labourers are also available.

F. Weed Management

The basin area of oil palm is kept free of weed growth through ring weeding. It is more important for young palms, roots of which are to be kept free from competition from weed. Depending on the extent of weed growth and rainfall, hand weeding is carried out even up to 4 times in a year during early years of plantation, which is progressively reduced to two times a year.

G. Water Management

Oil palm needs 1200–1500 mm of water to meet its monthly evapotranspiration needs. In areas where perennial water source is available, basin irrigation is possible. But where Terrain is undulating and water is scarce during summer months, drip irrigation is recommended to keep four drippers/palm in the weeded palm circle to supply at least 90 litres of water/palm/day during summer months.

H. Fertilizer Management

Supply of sufficient quantity of green leaves or compost is advantageous especially where the soil is poor in organic matter content. The fertilizer schedule is given below:

Age	Nutrients (gram/palm/year)		
	N	P	K
First year	400	200	400
Second year	800	400	800
Third year onwards	1200	600	1200

The fertilizers are preferably applied in two equal split doses during May-June and September-October by uniformly spreading them within a 2 m circle around the base of the palm and incorporate them into the soil.

I. Pest Management

To control rhinoceros beetle, Sevin 10% D at the 200 g admixed with equal quantity of sand is to be applied at the leaf base. Placing 3-4 naphthalene balls in the youngest spear axils at weekly intervals may be done.

J. Harvesting

Proper and timely harvesting of fruit bunches is an important operation which determine the quality of oil. The yield is expressed as fresh fruit bunches (FFB) in kg/ha/year or as oil/ha/year. The bunches usually ripen in six month after anthesis. Unripe fruits contain high water and carbohydrate and very little oil. As the fruit ripens, oil content increased to 80–85% in mesocarp. Ripeness of the fruit is determined by the degree of detachment of the fruit from branches, change in colour and change in texture of the fruit.

6. COCONUT (*Cocos nucifera*)

Coconut is grown in 93 countries in the world. Indonesia (32.20%) ranks first among the major coconut producing countries followed by Philippines (26.65%) and India (15.91%). India, Indonesia, Philippines and Sri Lanka together account for 78.27% of global coconut production. During 2004–05, in India, the production was 12160 million nuts (19.88% of world) and the productivity was 6337 nuts/ha (1st in the world).

Soil: Red sandy loam, laterite and alluvial soils are suitable. Only heavy soil, lacking drainage facilities is unsuitable.

Planting seasons: June-July, December-January.

Varieties: Coconut hybrids—VHC-2, VHC-3 (yielding starts from 3.5–4 years); ECT—for Tanjore, Thiruvapur and Nagai belts—yielding starts from 7.5 years; WCT—for Kanyakumari and Coimbatore areas—yielding starts from 7.5 years.

Spacing: Adopt a spacing of 25' × 25' with 175 plants/ha. For planting in field border as a single row, 20' spacing between plants may be adopted.

Planting: Pit size should be 3' × 3' × 3'. In the pits, Lindane 10% dust may be sprinkled to prevent white ant damage. The pit should be filled to a height of one foot with FYM, red earth and sand mixed in equal proportions. At the centre, the seedling should be planted after removing all the roots. The soil around the nut should be pressed well and the seedling should be provided with shade by using plaited coconut leaves or palmyra leaves.

Water management: In the first year, irrigation is given on alternate days and from the second year, till the time of maturity, irrigation should be given twice a week and afterwards once in 10 days. During summer months and also whenever there is no rain, irrigation is a must, depending upon soil moisture. Coconut requires about 100 l/day/tree through drip irrigation for matured plantation. The coconut husks at about 30 cm depth around the coconut trees at a radius of 1 m and covering it up with earth will conserve soil moisture in light textured soil. Use of coir waste as soil mulch around the tree to a thickness of about 3 cm is also advantageous to conserve soil moisture especially under scarcity condition. Drip irrigation is the best method of irrigation for coconut. Pitcher irrigation under severe water scarce condition (4 pitcher/tree) may be followed.

Manuring: For a five year old palm, 50 kg compost or FYM or green leaves, 1.3 kg urea (560 g N), 2 kg super phosphate (320 g P₂O₅) and 2 kg muriate of potash (1200 g K₂O) should be applied in 1.8 m circular basin, incorporated in soil and the basin is irrigated. Fertilizers may be applied in two doses, once in June - July and the second in December- January. Basal application of FYM (10 kg) + top dressing of NaCl (1 kg) 3 months after planting nuts or FYM + composted coir pith (10 kg) both as basal application is effective for the good growth of seedlings of East Coast Tall Variety. For 2, 3 and 4 years old seedlings, 1/4, 1/2, 3/4 doses of the above fertilizer schedule should be applied. Any one of the green manure crops like sunnhemp, wild indigo, calapagonium or daincha may be sown and ploughed in situ at the time of flowering as a substitute to compost applied in trenches. Manuring should be done when there is moisture in the field. The root activity is maximum around a radius of 1.5 m–2 m from the base of the tree. Application of fertilizer to the entire area around the palm is recommended and the fertilizer is forked in. Sufficient moisture should be present when manuring.

Inter-cultural operation: The inter-space in the coconut garden has to be ploughed twice in a year in June-July and December-January. Intercultural operation is essential to keep weed population under check; to ensure the utilization of the applied plant nutrients by the coconut trees; to facilitate proper aeration to the roots of coconut and to induce fresh root growth. Application of 0.5 kg N, 0.5 kg P₂O₅ and 0.75 kg K₂O/palm (Urea 1.1 kg, single super phosphate 3.1 kg, muriate of potash 1.2 kg/palm/year) is found economical for East coast Tall variety.

Inter cropping: During the first five years, groundnut, sesamum, sunflower, tapioca and turmeric can be grown as inter crops. In the shade of the well grown up plantation, cocoa, pineapple, banana and forage crops like desmodium and desmanthus can be raised. In multistoreyed cropping system, banana and pineapple combination with coconut gives higher net returns per unit area.

Pests and Diseases

(i) Rhinoceros beetle

- Remove and burn all dead coconut trees in the garden (which are likely to serve as good breeding ground) to maintain good sanitation. Collect and destroy the various bio-stages of the beetle from the manure pits (breeding ground of the pest) whenever manure is lifted from the pits. Incorporate the entomopathogen *i.e.*, fungus (*Metarhizium anisopliae*) in manure pits to check the perpetuation of the pest.
- Soak castor cake at 1 kg in 5 l of water in small mud pots and keep them in the coconut gardens to attract and kill the adults.
- Treat the longitudinally split tender coconut stem and green petiole of fronds with fresh toddy and keep them in the garden to attract and trap the beetles. Examine the crowns of tree at every harvest and hook out and kill the adults.
- For seedlings, apply 3 number of naphthalene balls/palm weighing 3.5 g each) at the base of interspace in leaf sheath in the 3 inner most leaves of the crown once in 45 days.
- Set up light traps following the first rains in summer and monsoon period to attract and kill the adult beetles.
- Field release of Baculovirus inoculated adult rhinoceros beetle reduces the leaf and crown damage caused by this beetle.
- Mixture of either neem seed powder + sand (1:2) @150 g per palm or Neem Seed Kernel powder + Sand (1:2) @150 g per palm applied in the base of the 3 inner most leaves in the crown effectively controlled rhinoceros beetle damage.

Special Problems in Coconut

1. **Rejuvenation of existing garden:** The low yield in vast majority of gardens is due to thick population, lack of manuring and irrigation. These gardens could be improved if the following measures are taken.
 - (i) **Thinning of thickly populated gardens:** In the farmer's holdings, 41 per cent of the trees give a yield of less than 20 nuts/palm/year. By cutting and removal of these trees, the yield could be increased by 1750 nuts/ha. Besides, there is saving in the cost of cultivation and increase in net profit to the tune of Rs. 2000/ha. After removal of low yielding trees, the populations should be maintained at 175–200 palms/ha.
 - (ii) **Ensuring adequate manuring and irrigation:** Research results have shown that the yield of coconut palms could be increased by 23 nuts/palms/year by applying the manurial schedule of 50 kg of FYM or green leaf plus NPK at 560, 320, 1200 g/palm. When irrigation at 10 days interval is also given during summer months in addition to manuring, the yield increase was 44 nuts/palm and when all these were combined (manuring + irrigation + cultural practices), the yield increase was 67 nuts/tree over control.
2. **Button shedding:** Shedding of buttons and premature nuts may be due to any one of the following reasons:
 - Excess acidity or alkalinity
 - Lack of drainage
 - Severe drought
 - Genetic causes

- Lack of nutrients
- Lack of pollination
- Hormone deficiency
- Pests and diseases

The following remedial measures are suggested:

- (a) **Rectification of soil pH:** Excess acidity or alkalinity of soil may cause button shedding. If the soil pH is less than 5.5, it is an indication of excess acidity. This could be rectified by adding lime. Increase in alkalinity is indicated by soil pH higher than 8.0. This situation could be rectified by adding gypsum.
- (b) **Providing adequate drainage facilities:** Lack of drainage results in the roots of coconut trees getting suffocated for want of aeration. Shedding of buttons occur under such condition. Drainage channels have to be dug along the contours to drain the excess water during rainy season.
- (c) **Burial of coconut husk or coir waste:** Severe drought condition and lack of irrigation during summer result in button shedding. To rectify the situation coconut husks may be buried @ 100 husks with concave surface facing upwards or 25 kg of coir waste in semi circular trenches, dug to one foot width and two feet depth at 1.5 m radius. This may be applied at the bottom and the usual manures and fertilizers applied above this layer, when there is moisture in the soil. The monsoon rains are preserved by the soaking of the coconut husk or coir waste as the case may be. Besides decomposition, of these materials provide addition of potash to the coconut.
- (d) **Genetic causes:** In some trees, button shedding may persist even after ensuring adequate crop pest and disease management. This is an indication of inherent defect of the mother palm from which the seed material was obtained. This underlines the need for proper choice of superior mother palm for harvesting seed coconut to ensure uniformly good yielding trees.
- (e) **Lack of nutrition:** Button shedding occurs due to inadequate or lack of manuring. The recommended dose of manurial schedules and proper time of application are important to minimize the button shedding. Apply extra 2 kg of K_2O with 200 g of Borax/palm over and above the usual dosage of fertilizer to correct the barren nuts in coconut.
- (f) **Lack of pollination:** Button shedding also occurs due to lack of pollination. Setting up of bee hives at 15 units per ha may increase the cross-pollination in the garden. Further the additional income obtained through honey, increases the net profit per unit area.
- (g) **Hormone deficiency:** The fertilized female flowers shed in some cases. By spraying 2–4 D at 30 ppm, the setting percentage could be increased to 32.5 per cent as against 25 per cent in the control. The chemical 2–4 D may be mixed at 30 mg per litre of water and sprayed one month after opening of the spathe using micro sprayer.
- (h) **Pests:** Button shedding may happen due to the attack of bug. Spraying of systemic insecticides like Methyldemeton 0.025% or Dimethoate 0.03% may reduce the occurrence.

IPM for red palm weevil: The dead palm has to be disposed off and the stump burnt. The garden should be kept clean. Root feeding of Monocrotophos @ 10 ml + 10 ml of water/palm given with due precaution, viz., (i) Harvest and nuts before root feeding and subsequent harvests done 45 days after root feeding and (ii) irrigation has to be given to root fed palms only after a week (or) Apply 1–2 Aluminium phosphide tablets in the bore holes and plug it immediately with moist cement and Fytolan.

(i) **Diseases:** Button shedding also occurs due to disease incidence such as Thanjavur wilt. Adoption of control measures suggested for the disease reduces not only spread of the disease but also prevents shedding of buttons.

Management of thanjavur wilt of coconut: The management practices for the disease will be effective, only if they are adopted in the early stage of the disease *i.e.*, as soon as bleeding symptoms are noticed. In sandy soil, organic matter status of the soil has to be improved. For this, green manure crops may be raised and ploughed *in situ* or well-decomposed farm yard manure at 50 kg per palm has to be applied every year. Only if organic manures are applied, the fungicides will be effective. Bordeaux mixture (1%) drenching should not be done in summer months especially during March, April, and May. When Bordeaux mixture drenching and root feeding of Calixin or Aureofungin-sol + Copper sulphate are done, the palms should be irrigated only after 4–5 days. For Bordeaux mixture drenching, the soil should be completely dry. Then only 40 litres solution will be required to drench at least 4–5" depth of soil. Latest method of application for Aureofungin-sol is root feeding (2 g Aureofungin sol + 1 g copper sulphate in 100 ml of water) and not stem injection. Neem cake (5 kg) also should be applied to diseased trees every year. Neem cake application should not be combined with Bordeaux mixture drenching. There should be at least one-month interval between neem cake application and Bordeaux mixture drenching. If the above precautions are carefully followed and the integrated control measure of organic manure application, cultural practices (summer irrigation) and fungicides application are adopted Thanjavur wilt in coconut can be kept under check.

Coconut nursery management: The seed for collecting seed materials from high yielding coconut palms can hardly be over emphasized in a perennial crop like coconut. The following points may be remembered:

- Select seed gardens, which contain large proportion of high yielding trees with uniformity in yielding ability.
- High yielding mother palms giving not less than 100 nuts/palm/annum should be chosen for collecting seed nuts. Alternate bearers should be avoided. The age of the palm chosen be middle age *i.e.*, from 25 to 40 years. Even trees with 15 years age can be selected, if it is high yielding and has stabilized yield.

15.8 SUGAR CROPS

1. SUGARCANE (*Saccharum officinarum*)

The world sugar is derived from the Sanskrit word 'Sakkara' or Sarkara. Sugarcane is the main source of sugar in India and holds a prominent position as a cash crop. India has the largest area under sugarcane in the world and also ranks first in sugar production. Sugarcane juice is used for making white crystal sugar, brown Kandasari sugar and Jaggery (Gur). By products are bagasse and molasses. Bagasse is used for manufacturing ethyl alcohol, butyl alcohol and citric acid. Green tops are used as fodder. Press mud is used as organic manure.

The average cane productivity of sub-tropical north zones (Punjab, Haryana, Uttar Pradesh, Bihar, West Bengal, Assam, and Uttaranchal) is 55.2 t/ha in comparison to 75.3 t/ha of tropical south zone (Andhra Pradesh, Gujarat, Karnataka, Maharashtra and Tamil Nadu). To get maximum possible yield of sugarcane, about 180-200 '000 millable canes/ha, each of 2 kg wt are required.

A. Origin

India

B. Classification

Sugarcane belongs to the genus *Saccharum*, Graminae family. Cultivated cane is classified into 3 species.

- *Saccharum officinarum*: These are thick juicy canes and good for chewing.
- *Saccharum sinensis* : This species is in northern India and has long and thin stalks with low to medium sucrose.
- *Saccharum barberi*: It is indigenous to north-eastern India and has thin stalks with medium sucrose—early maturing.

Wild species are: (a) *Saccharum spontaneum*, and (b) *Saccharum robustum*.

C. Climate

It is a tropical plant. It can grow in subtropical climates like north India. It is being cultivated within 35°S and 35°N of the equator in tropical regions. Temperature above 50°C and below 20°C slows down the growth. Average of 26–32°C is suited for cane growth.

D. Soil

All types of soil from sandy loam to clay loam soils are suited. Well-drained loamy soils are highly preferred.

1. SUGARCANE – PLANT CROP (main crop)

(a) Season:

Main season: There are three main seasons.

- | | | |
|-----------------------|---|------------------|
| • Early season | – | December–January |
| • Mid season | – | February–March |
| • Late season | – | April–May |
| Special season | – | June–July |

(b) Varieties: COC 671, COC 771, COC 772, COC 773, COC 800 (C 66191), COC 774, COC 775, COC 776, COC 777, COC 778, COC 779, COC 419, CO 6304, COC 8001, COC 85061, COC 86062, COC 86071, COC 90063, CO 8021, COC 91061, CO 8362, COG 93076, CO 8362, COG 93076, CO 8208, COG 94077.

For jaggery production: COG 95076, CO 85019, COSI 95071, COSI 96071, CO 8610, COC 98061, COSI 98071, CO 86249.

In parts of Trichy, Salem and Coimbatore districts of Tamil Nadu, the varieties noted below are susceptible to sever incidence of disease and should be replaced by new introductions:

Variety	Diseases
CO 419, CO 740	Smut
CO 62198	Grassy shoot.

(c) Field preparation: Wet land (Heavy soils): The field is ploughed with disc plough and country plough. Ridges and furrows are formed with a spacing of 80 cm between rows with mammutti/spade. Digging with hand hoes in the furrows and stirring the furrows is done. The soil is allowed to weather for 4–5 days.

Garden lands and medium and light soils: Deep ploughing with tractor is done using disc plough and cultivator and fine tilth is obtained. Ridges and furrows are formed at 80 cm apart with the help of victory plough. The depth of the furrow must be 20 cm. Irrigation channels are formed at 30 cm depth at intervals of 10 m.

(d) Preparation of setts: Seed materials are taken from a short crop (6–8 months nursery cane) free from pest and diseases.

- Detrashing the cane with hand is done. A sharp knife is used to prepare setts without splits.
- Setts with splits, damaged buds, sprouted buds etc. are removed.
- Sett treatment with Azospirillum (Prepare the slurry with 10 packets (2000 g/ha) of Azospirillum inoculums with sufficient, water and soak the setts in the slurry for 10–15 minutes before planting) is done.

(e) Seed rate: About 75,000 two budded or 50,000 three budded or 1,87,500 single budded setts/ha (for single and direct planting) are needed.

(f) Planting: Irrigation is given first in the furrows to form a slurry.

- The sets are placed end to end in the center of the furrows keeping the buds in the lateral position and press the setts just to the ground level in the furrow.
- Avoid exposure of setts to sunlight.
- Plant extra setts near the channel for gap filling later.
- Fill up gaps, if any within 20 days after planting with sprouted setts.
- Maintain adequate moisture for 3 weeks for proper establishment of setts.

(g) Trash mulching: Mulch the ridge with cane trash may be done to a thickness of 10 cm uniformly three days after planting to tide over drought and as moisture conservation, weed control and minimizing shoot borer incidence. Mulching the field with trash is done only after 21 days in the case of heavy soil and wetland condition. Trash mulching should be avoided in areas where incidence of termites is noticed.

(h) Growing intercrops: In areas of adequate irrigation, one row of soybean, black gram or green gram along the center of the ridge on the 3rd day of planting is done. In some areas, sunnhemp is raised and will be incorporated at the time of partial earthing up on 45 DAS.



Fig. 15.16 Intercropping-sugarcane + sunnhemp

(i) **Weed management:** Spraying of atrazine 2 kg or oxyflurofen at 750 ml/ha mixed in 900 litre of water as pre-emergence herbicide on the 3rd day of planting using deflector or fan type nozzle. If herbicide is not applied, the junior hoe is used along the ridges on 25, 55 and 85 days after planting for removal of weeds and proper stirring. The weeds along the furrow are removed with hand hoe.

(j) **Earthing up:** On 45th DAP, a partial earthing up is given after application of 3rd dose of fertilizer (90days) and it is repeated on 150 DAP.

(k) **Detrashing:** The dried leaves are removed alone on 150th and 210th DAP.

(l) **Propping:** Double line propping is done with trash twist at the age of 210 DAP.

(m) **Top dressing with Fertilizers:**

Soil application: Super phosphate (375 kg/ha) is applied along with furrows and incorporated with hand hoe.

Ensured water supply areas (costal and Flow irrigation belts)	275 kg N and 112.5 kg K ₂ O/ha in 3 equal splits around 30, 60 and 90 DAP
Lift Irrigation belt (Water scarcity area)	225 kg N and 112.5 kg K ₂ O/ha in 3 equal splits around 30, 60 and 90 DAP
For Jaggery area	175 kg N and 112.5 kg K ₂ O/ha in 3 equal splits around 30, 60 and 90 DAP

Foliar application: N application may be done by the following method:

Foliar spray

1st Dose—Apply 55 kg N/ha to soil on 30th DAP.

2nd Dose—Apply 55 kg N/ha to soil on 60th DAP.

3rd Dose—Foliar spray of urea by dissolving 62.5 kg of urea in 850 litres of water (For high volume spray) or 312 litres of water (for low volume spray on 90th DAP). It is repeated on the 110th DAP. By this method 37.5 kg of N can be saved.

(n) **Water management:**

<i>Stages</i>	<i>Days of irrigation interval</i>	
	<i>Sandy</i>	<i>Clay</i>
Germination phase (0–35 days)	6	8
Tillering phase (36–700 days)	8	10
Grand growth phase (101–270 days)	8	10
Maturity phase (271–harvest)	10	14

(o) **Harvesting:** The age for harvest is decided in relation to varieties and time of planting.

- Early varieties to be harvested when 10–11 month old and mid season varieties when 11–12 months old.
- Harvest the cane at peak maturity; cut the cane to ground level for both planted and ratoon crop.



Fig. 15.17 Drip fertigation unit–sugarcane

2. SUGARCANE – RATOON CROP

(a) **Management of the field after harvest of the plant crop:** Follow the operations within 10 days of harvest of planted crop to obtain better establishment and uniform sprouting of shoots. The following steps are to be taken:

- Remove the trash but do not burn it. Irrigate the field copiously.
- Fallow stubble shaving with sharp spade to a depth of 4–6 cm along the ridges.
- Fill in gaps with sprouted stubbles or settling or setts.
- Apply basal dose of organic manure and super phosphate along the sides.

(b) **Management of the crop:** Different operations similar to planted crop are followed:

- Spray Ferrous sulphate at 2.5 kg/ha in 150 litres of water on the 15th day. If chlorotic condition persist, repeat twice further at 15 days interval and add urea 12.5 kg/ha in the last spray.
- Hoeing and weeding on 20th day and 40th–50th day
- First top dressing on 25th day, 2nd on 45th–50th day
- Final manuring as 70th–75th day.
- Partial earthing up on 50th day. If Junior hoe is work two or three times up to 90th day, partial earthing up is not necessary.
- Final earthing up on 90th day
- Detrashing between 120th and 180th day
- Trash twist propping on 180th day
- Harvest after 11 months.

3. SHORT CROP (Nursery crop)

Selection of proper planting months for raising nursery crop in relation to main field planting is very important. Six to eight months old nursery crop is raised in relation to main field planting in the following lines.

<i>Raise nursery crop during</i>	<i>To transplant during</i>
June	December–January (Early season)
July	February–March (Mid Season)
August	April–May (Late Season)
December	June–July (Special Season)

Pest management

- (a) **Shoot borer:** Carbofuran 3G 33 Kg (Soil application) or monocrotophos at 1000 ml is used.
- (b) **Internode borer:** Egg parasite *Trichogramma chilonis* at 2.5 cc/release/ha is released. Six releases for every sixteenth day starting from fourth months onwards will be necessary. Detrashing is done at 150th and 210th DAP.

Disease management

- (a) **Grassy shoot disease:** The grassy shoot disease is appearing in several tracts. The setts are treated with aerated steam at 50°C for 1 hr to control primary infection of shoot disease. The infected plants are roughed out in the secondary and commercial seed nursery. Seed canes are selected from the middle of the field.
- (b) **Rust:** Spraying Mancozeb at 2.0 kg/ha is followed.

15.9 NARCOTICS

1. TOBACCO (*Nicotiana* sp.)

Tobacco is an important cash crop. The tobacco crop is grown for its leaves, which are used as a cured product. India ranks third in the world tobacco production and second in flue cured tobacco exports. This crop occupies a pride of place with an export earnings of Rs. 1320 crores and excise revenue of Rs. 72470 crores annually. The crop offers significant employment opportunities in rural India and provides livelihood to 36 million people annually in cultivation, curing, grading, factories and cottage industries, but also earns billions of dollars through trade and business. An industrial product of considerable importance is nicotine sulphate, which is prepared from tobacco for use as an insecticide and for the preparation of tobacco cessation products, drugs and the ameliorative effect on different diseases. At present, nearly 270 tonnes of 40% nicotine sulphate valued at Rs. 38 million are being exported from India. Solanesol is a naturally occurring tri-sesquiterpene alcohol present in tobacco and it is very in the pharmaceutical industry.

A. Origin

Tobacco originated in the Western hemisphere, and the types of tobacco presently being cultivated evolved in Mexico and Central America. In India, tobacco was introduced during the early part of the 17th century by the Portuguese.

B. Area and Distribution

In tobacco production, India ranks third after China and Brazil and 5th largest exporter after Brazil, China, USA and Malwi. It accounts for about 10 per cent of the area and 8 per cent of production in the world. It is cultivated in 4 lakh ha of area and accounts for 0.27% of the total cultivable area in the country. India's production is 700 million kilograms. The principal tobacco growing states in the country are Andhra Pradesh, Gujarat, Karnataka, Tamil Nadu, Orissa, West Bengal, Bihar, Maharashtra and Uttar Pradesh.

C. Classification

Indian tobaccos are classified into two species namely *N. tobaccum* and *N. rustica*.

I. *N. tobaccum*:

- The plants of this species are usually taller attaining a height of 1.5–2.5 m.
- The leaves are larger but rather narrow.
- They may be sessile or petiolate.
- The colour of the flower is reddish, pinkish or white.
- It is used extensively for smoking and chewing purposes.
- It is used in manufacturing cigarettes, cigars, cheroots, bidi, chewing and snuff purpose.

II. *N. rustica*:

- The plants of this species are stocky, more bushy in nature and also shorter in height, usually not more than 0.9–1.2 m in height.
- The leaves are large and broad and ovate in shape and always possess a petiole.
- Flowers occur in cluster and are of dull greenish yellow colour.
- It is used extensively for hookah, chewing and snuff purposes.

D. Climate

Although tobacco is a tropical crop, it can be grown in a wide range of environments. In India, tobacco is grown from 8°N latitude to 34°N latitude. Tobacco seeds require about 21°C temperature for germination. Temperature between 27°C and 32°C are desirable for rapid and uniform germination.

E. Soil

Quality of tobacco is greatly influenced by the soil conditions. Tobacco is adopted to moderately acidic soils with a pH ranging from 5.5–6.5. Tobacco will not do well in water logged soils as it is sensitive to water logging and impeded drainage.

F. Improved Varieties under Different Tobacco Types

Type	Improved varieties
Flue cured	Kanakaprabha, CTRI, Special, Jayasri, Line 1494, Line 2359, Virginia gold.
Natu	Prabhat, DG.3, DG.4
Burley	Momi-2, Burley-24, Ky 58, Ky 21, Ky 16.
Cigar wrapper	S.5, Dixie shade, Rangpur Sumatra
Cigar filter	Olor-10, Havana, Swanbileshman, Maryland

(Contd.)

<i>Type</i>	<i>Improved varieties</i>
Cheroot	Ok.1, Bhavani special, DR-1, Line 2331
Chewing	Bhagyalakshmi, Thangam, Vairam, Sona, Gandak Bahar
Hookah and chewing	DD.413, 414, 415, 417, 417, Dp 401, HD 65-40.
Bidi tobacco	Anand 3, Anand 23, Akolgund, Bhjgund, Annekevi.

G. Field Preparation

A clean and well pulverized seed bed of good tilth is needed for transplanting tobacco seedlings. Land should be well prepared first and by deep ploughing with mould board plough followed by 3-4 cross harrowings. Each harrowing should be followed by planking so that the soil is well pulverized and levelled. Care should be taken to see the weeds, stubbles etc are well removed from the field. Red sandy loam soils are preferred for nursery.

H. Seed and Sowing

Tobacco seeds are very small and so are not sown directly in the field but are raised in a nursery. Tobacco seedlings are raised in specially prepared raised seed beds (1.25 m width × 10 m length). Usually, at least 6-8 weeks are required to obtain transplantable seedlings.

I. Raising Seedlings

Application of FYM or compost at 12.5 kg + 80 g of super/2.5m² as a layer on the top of the beds is found to be highly beneficial in giving higher number of seedlings. The optimum time for sowing the nursery is the second fortnight of August. A seed rate of 200-300 g per ha is quite sufficient. As the size of the seed is very small, it should be mixed with sufficient quantity of sand and evenly distributed over the bed by sowing twice. Watering of nursery beds should be done carefully. The beds should always be kept moist but not wet. In the initial stages, on a sunny day 5-6 watering will be needed. Rose cane is used for watering. Under favourable conditions, germination starts from 5th day and completed (5-12 days) by 12th day. If the seedlings are over-crowded in some places, they can be thinned out, when three weeks old. Normally, the seedlings will be ready for transplanting in 6-8 weeks time (42-56 days).

J. Transplanting and Manuring

The field for transplanting tobacco seedlings should be well prepared. A few hours before transplanting, nursery beds should be well watered to facilitate easy removal of seedlings without root damage. Fifteen cm height seedlings with 5-7 leaves are good for cigarette tobacco, but bidi tobacco requires smaller seedlings. Seedlings should be transplanted immediately after pulling. Transplanting should be done in the late afternoon to avoid heat injury. Optimum time of planting and spacing vary with the type of Tobacco as given below:

Flue cured (black soil)	:	80 × 60 cm
Flue cured (light soil)	:	100 × 60 cm
Cheroot	:	60 × 45 cm
Natu (rain fed)	:	90 × 90 cm.

Transplanting is usually done in the month of October-November in case of winter crop while at the end of March or in the beginning of April for the second or summer crop. Immediately after

transplanting light, irrigation should be done. Plants, which have not established well, should be replaced with fresh seedlings within a week of transplanting.

	N	P	K	kg/ha
Flue cured (Black soil)				
Flue cured (light soil)	:	100	100	50
On 45 and 60th DAP				NP & K in equal splits
Cheroot	:	50	50	100
Natu (rain fed)	:	40 kg N alone		

In addition to the inorganic fertilizers, application of organic manure in the form of FYM or compost at 25 t/ha or Neem cakes at 250 kg/ha may be done.

K. Water Management

Water requirement of tobacco crop depends upon the type of tobacco and the region where it is grown. In case of cigar and cheroot tobaccos, more frequent light irrigations are needed. In Tamil Nadu, about 20–22 irrigations at 48 hours intervals starting after seedling establishment for chewing and cigar filter tobaccos are required. Up to 45 days, irrigation is given once in 3–4 days interval and at maturity stage, it is given once in 4–5 days intervals.

L. Weed Control

Intercultural operations should start after 10–15 DAT, when the seedlings are well established. Orabanche, which is a root parasite and is a menace to the tobacco crop is kept down by hand pulling. The only way to control this weed is to collect and destroy it before seed formation. Trap cropping of green gram or gingerly or sorghum reduces the infestation. One hand weeding at three weeks after transplanting (or) application of pre-emergence herbicide Fluchoralin at 1 lit/ha or oxyflourfen at 0.5 lit/ha one week prior to planting is recommended.

M. Topping

When flower heads begin to show, the plants are topped by removing off the top of the plant. Topping means removal of the terminal bud. This practice stimulated the development of the remaining leaves. It is a very important operation for the quality of tobacco leaf. It gives an uniform quality product leaving 10 leaves on the plant, besides 2 end leaves.

N. Desuckering

Removal of these suckers is called desuckering. Manual removal of suckers by hand 4–5 times at weekly intervals is done. The main aim of topping and de-suckering operations is to divert the energy and nutrients of the plant from flower head to leaves, which influence the yield and quality of tobacco.

O. Harvesting

The right stage for harvesting the crop is when the leaves are matured *i.e.*, when the normal 1. green colour changes to yellowish green or slightly yellowish, 2. become thick, spotted and sticky to touch, 3. appearance of brown spots on the leaves, and 4. bulging of interveinal portions on the leaves. If such leaves are bent under thumb, a cracking sound is produced. There are two methods of harvesting tobacco.

- (i) **Priming:** Harvesting is done by removing few leaves as and when they mature from bottom to top.

- (ii) **Stalk cut method:** In this method, the entire plant is cut close to the ground with sickle and left over night in the field for wilting.

P. Curing

Curing is a process by which harvested tobacco leaf is made ready for the market. There are four common methods of curing.

1. Flue Curing: The harvested leaves are strung on sticks, which are then stacked in a flue curing barn. The barn is artificially heated. The curing process consists of 3 stages.

- (i) **Yellowing:** During yellowing, leaf is kept at a low temperature (32–35°C) and high humidity for about (30–40 hrs) till it attains a bright lemon yellow colour.
- (ii) **Fixing colour:** After yellowing, the temperature is raised gradually and humidity of barn is lowered by opening the ventilators with rapid rise in temperature when the leaf is still wet results in a bluish-black discolouration called scalding. It takes about 16–24 hrs.
- (iii) **Drying:** The ventilators are closed and temperature is again gradually raised to 160°F to dry the veins and mid ribs of leaves. This takes about 28–42 hrs. Then, ventilators are opened to cool down the barn. The leaves are left in barn overnight for observing moisture to come to normal condition for handling and storage.

2. Air curing: The leaves are divided into groups according to their sizes and are strung on the string secured on a bamboo stick. These sticks are taken to barn with closed sides and roof. The leaves are cured under atmospheric temperature and relative humidity of 70–80% is maintained by sprinkling water inside the barn. The entire process is over in about five to six weeks.

3. Fire curing: The leaves are harvested in such way that a small portion of stem remains attached to the leaves. The leaves are wilted for a few hours in the field, then tied into bundles and hung in a smoke hut. They are smoked for about 12 hours by burning dried leaves of trees locally available. After smoke treatment, the leaf is fermented in bulks for about 3–4 weeks. The fermented leaves are given treatment with salt water or jaggery solution.

4. Suncuring: Sun curing is done in three ways.

- (i) **Curing whole plants on racks:** After initial wilting in the field, the plants are strung on bamboo poles and cured in sun. Entire process takes about 15–20 days.
- (ii) **Curing leaves with pieces of stems or racks:** Here, racks are not exposed to direct sun, therefore it takes longer period (6–8 weeks).
- (iii) **Curing whole plant on the ground:** Here, leaves are allowed to dry in sun on the ground and are turned over twice a day. This process continues for about a week and then heaps are made which are opened on the next day and reheaped. This process of heaping, opening the heaps, spreading and reheaping is continued for about 10–15 days. By the end of this period, leaves becomes completely cured. For reducing the cost, stringing can be done on wire at 15–22 cm distance. By the process of turning, the plants on poles could completely be eliminated.

15.10 FIBRE CROPS-MAJOR

1. COTTON (*Gossypium* Sp.)

Cotton plays a key role in Indian national economy in terms of both employment generation and foreign exchange earnings (more than Rs. 50,000 crores). It generates employment for about 60 million people either directly or indirectly involved in the agricultural and industrial sector of cotton production, processing, textile and related activities. It is the oldest among the commercial crops of the world.

Cotton is chiefly grown for its use in the manufacture of cotton for the mankind. It is also used for making the reads, for mixing with other fibres and extraction of oil from cottonseed. Oil content ranges from 15–25% depending upon the varieties. Cottonseed cake after oil extraction is a good organic manure and contains about 6% N, 3% P and 2% K. Cottonseed, cotton linters and pulp are good cattle feeds.

A. Origin

Cotton has been used as a fibre in India from time immemorial. It has been cultivated for more than 5000 years in Indus valley. The cultivation of cotton spread from India to Egypt and then to Spain and Italy. Every evidence shows that India is the origin.

B. Area and Distribution

India is the largest cotton growing country in the world. It ranks third in production next to China and U.S (with a share of 12% at global production). In the world, Cotton is cultivated in 33 m.ha with a total production 42 m. t. of seed cotton. Important cotton growing countries are India, USA, Russia, China, Brazil, Egypt, Pakistan, Turkey, Mexico and Sudan. These countries nearly account for 85% of total cotton production. Cotton is cultivated in India from sub-Himalayan region of Punjab in north to Kerala in south and from dry regions of Kutch to high rainfall areas of Manipur in east. Among the cotton growing countries, India occupies the foremost position in area and the area under cotton is 8.5–9.0 m.ha (more than 65% of cotton in rainfed). The productivity is 462 kg lint/ha during 2004–05. Production is 24.3 million bales. The world average productivity is 642 kg lint/ha. The Indian area accounts 25% of the world cotton acreage, but production is only 9% of the total world seed cotton output. Gujarat is the largest producer of cotton followed by Punjab, Maharashtra, Madhya Pradesh, Karnataka, Andhra Pradesh and Uttar Pradesh.

C. Classification

Cotton belongs to the Malvaceae family and the genus *Gossypium*. According to Hutchison (1947), the following four cultivated species are popular in India.

<i>Gossypium arboreum</i> (n = 13)	
<i>Gossypium herbaceum</i> (n = 13)	Desi cotton.
<i>Gossypium hirsutum</i> (n = 26)	
<i>Gossypium barbadense</i> (n = 26)	American cotton

G. Arboreum: Plant height is 1.5–2 m, leaves have seven lobes, leaves and twigs are pubescent, fibres are coarse and short with 1.25–2.10 cm length. It covers 29% of cotton area in the country.

G. Herbaceum: Plant height is 1–1.5 m. Leaves and twigs sparsely hairy. Leaves have 3–6 lobes. Fibre length is 1.25–2.30 cm. It covers 21% of the cotton area.

G. hirsutum: It is commonly called as “American cotton” and plants are 1.5 m tall. Leaves and twigs are densely hairy. Leaves have 3–5 lobes. Fibre length is 1.8–3.1 cm. It covers about 50% of the cotton area.

G. Barbadosense: It is commonly called as ‘Sea Island Cottons’. Plants are about 2.5 m tall. Leaves are deeply lobed with 3–5 lobes and fibre length is 3.6–5.0 cm. Lint is readily detachable from the seeds. Area is only few thousand ha.

D. Climate

Cotton is a warm season crop. A daily minimum 16°C required for germination and 21–27°C for proper

vegetative growth. It can tolerate as high as 43°C but does not do well if the temperature falls below 21°C. During fruiting, day temp ranging from 27–32°C and cool nights are required. Abundant sunshine during the period of ball maturation and harvesting is essential for obtaining good quality produce. Cotton cannot withstand frost and its cultivation is restricted up to 1000 m. altitude.

E. Soils

Cotton can be successfully grown on all soils except the sandy, saline and water logged soils. It is grown in sandy loam, clay loam, loam, alluvial soil, black cotton soil and in red sandy loam soils. Cotton needs a soil with good moisture holding capacity. Good drainage and aeration are also essential as it cannot withstand water logging.

F. Season and Varieties

The seasons and varieties of cotton are given below:

- Winter irrigated (August–September) in Coimbatore, Erode, Salem, Dharmapuri and Villupuram areas of Tamil Nadu—MCU-5, MCU-9, MCU-11, Suvin, HB-224, Jayalakshmi, TCHB 213 etc.
- Summer irrigated (February–March) in Erode, Madurai, Ramnad and Tirunelveli areas of Tamil Nadu—MCU 5, MCU 9, LRA 5166, SVPR 1 etc.
- Short duration (January–February) in Erode, Madurai, Trichy, Tanjore and Villupuram areas of Tamil Nadu—MCU 7.
- Medium duration (January–February) in Trichy, Tanjore, Villupuram and Erode areas of Tamil Nadu—LRA 5166.
- Rain fed (September–October)—Madurai, Ramnad, Virudhu Nagar, Dindugal and Dharmapuri areas of Tamil Nadu—MCU.10 LRA 5166, K.10, K.11, Paiyur1, K 9.
- Rice fallow (February–March) in Tanjore, Trichy and Villupuram areas of Tamil Nadu—ADT 1, MCU 7.

G. Land Preparation

The field is ploughed and prepared to a fine tilth. Application of 12.5 t FYM/ha is recommended as basal. Ridges and furrows are formed at 10 m long with spacing depending upon the variety by using ridge plough or bund former.

MCU 5, MCU 9, MCU11, LRA 5166	75 × 30 cm
MCU 7, MCU 10, K. 10, SVPR1	60 × 30 cm
Jayalakshmi, TCHB 213, HB 224	120 × 60 cm
Suvin	90 × 45 cm

H. Seed Rate

	Quantity of seed (kg/ha)		
	<i>Seed with Fuzz</i>	<i>Delinted seeds</i>	<i>Naked seeds</i>
MCU 5, MCU 9, MCU 7, MCU 11	15	7.50	–
Suvin	–	–	6.0
Jayalakshmi, HB 224	3.75	2.50	–
TCHB 213	1.00	–	–

I. Acid Delinting

The following procedure may be followed for acid delinting of cotton:

- Chose plastic basket for acid delinting. Don't use earthenware and metal vessels.
- Put the required quantity of seeds in the container and add commercial concentrated H_2SO_4 at 100 ml/ha of fuzzy seeds.
- Stir vigorously and continuously with wooden stick for 2–3 minutes still the fuzzy sticking to the seeds is completely digested and the seed coat attain a dark brown colour of coffee seeds after roasting.
- Add water to fill container, drain the acid water and repeat the washing 4–5 times to remove the acid completely.
- Remove the ill filled and floating seeds while the healthy and good seeds remain in the bottom.
- Drain the water completely and dry the delinted seeds in shade.

Advantages

- Eliminates some externally seed borne pathogenic organisms.
- Kills eggs, larvae and pupae of pink boll worm.
- Helps to remove immature, ill filled and damaged seeds.
- Makes seed dressing more effective and easy.
- Facilitates easy sowing.

After acid delinting, the seeds are treated with carbendazim or captan or thiram at 2 g/kg of seeds.

J. Sowing

The seeds are dibbled at a depth of 3 cm in furrows and covered with soil.

	Fuzzy seeds	Delinted seeds
Jayalakshmi, TCHB 213	2	1
All other varieties	3	2

K. Fertilizer Application

Seed treatment with azospirillum 3 packets and soil application of 2 kg with 25 kg FYM is recommended. The fertilizer schedule for Tamil Nadu varieties is given below:

MCU7, ADT1	60	30	30	kg NPK/ha.
MCU 5, MCU 9, MCU 11, Suvin	80	40	40	kg NPK/ha.
Jayalakshmi TCHB 213, HB 224	120	60	60	kg NPK/ha.

50% of N and full dose of P and K is applied basally and the remaining 50% N is applied at squaring stage. Application of 12.5 kg of micro nutrient mixture is also recommended.

L. Weed Management

Application of pre-emergence herbicide fluchoralin at 2 l/ha or pendimethalin at 3.3 l/ha followed by a hand weeding on 35–40 DAS is recommended. The field is irrigated immediately after herbicide application. Gap filling at 10 days after sowing and thinning at 15 DAS allowing one seedlings per hole is followed. The ridges and furrows are reformed after first top dressing in such a way that the plants

are on the top of the ridges and well supported by soils. Spraying of NAA at 40 ppm is done to prevent early shedding of buds and squares at square formation and repeated the spray at one month after first spraying.

M. Nipping

To arrest the excessive vegetative growth, the terminal portions are nipped. For the varieties MCU 5, MCU 9 and MCU 11, nipping is done beyond 15th node at 70–80 DAS. For the varieties Suvin, Jayalakshmi and TCHB 213, nipping is done beyond 20th nodes at 90 DAS.

N. Pest Management

For managing white fly, tolerant varieties LPS 141 and Supriya may be tried. The other techniques are as follows:

- Adopting crop-rotation with non-preferred hosts such as sorghum, ragi and maize.
- NSKE—Neem seed kernel extract 5% or neem oil at 5 ml/l or monocrotophos 36 WSC 1.25 l/ha.

To control Thrips, Aphids, Leaf hopper	– Monocrotophos 1000 ml/ha
To control Bollworms and pink boll worm	– Endosulfan 0.07% and Triazophos 0.1%.
To control Tobacco cut worm	– Chlorpyriphos 20EC 2.0 l/ha

O. Disease Management

To control bacterial leaf blight	– Copper oxy chloride 2.5 kg/ha
To control alternaria leaf spot	– Mancozeb 1.0 kg/ha
To control boll rot	– Carbendazim 500 gm
To control root rot	– Spot application of Carbendazim at 1 g/l

P. Irrigation Management

Irrigation management may be followed as given below:

<i>Stages</i>	<i>Period</i>	<i>Irrigation at DAS after dibbling</i>	
Germination	1 to 15	Irrigate immediately at 5 DA sowing	
Vegetative	16 to 44	Irrigate at 20 DAS and 3 DAY after 1st hoeing.	
Flowering	45 to 100	Light Soil	Heavy Soil
		48th	55th
		60th	70th
		72nd	85th
		84th	100th
		96th	—
Maturity phase beyond 100		once in 20 days.	

S. Harvesting

The kapas are picked only from well burst bolls in the morning up to 10–11 A.M. Harvesting is done at 7 days interval. The kapas are sorted out from stained, discolored and insect attacked kapas. Then they are dried in shade and the kapas are kept over sand placed as a thin layer.

2. JUTE (*Corchorus Sp.*)

Jute and mesta (together called Raw jute) are cultivated in about 9.00 lakh ha with production of 95.39

lakh bales annually. Productivity is 9.55 bales or 19.12 q/ha when jute and mesta are taken together. It is cultivated in 0.8 m.ha in seven states (eastern and north-eastern states). About 4 million farmers, 0.25 million industrial workers and 0.5 million trader find gainful employment in jute sector. Jute can be grown in the areas where assured supply of irrigation water is available for cultivation and retting and extraction of fibre. In Tamil Nadu, it is cultivated in Coimbatore, Villupuram, Vellore, Chengalpet, parts of Tanjore and Trichy districts.

A. Soil

Alluvial sandy loam and clay loam soils are highly preferred. *Capsularis jute* can grow even in standing water but *Olitorius* will not thrive in standing water.

B. Season

The best season is February–May.

C. Manuring

Application of 5 t FYM and 20:20:20 kg of NPK as basal is recommended. Top dressing of N is done at 10 kg each at 20–25 days and 35–40 days after sowing.

D. Varieties

Capsularis Jute :	JRC 212, JRC 321, JRC 7447
Olitorius Jute :	JRO 524, JRO 878, JRO 7835

I. *Corchorus capsularis* (White Jute)

- 1. Sabuj sona (JRC 212):** It is a full green variety suitable for sowing during first week of March to middle April. Optimum time of harvest is 125–135 days. It is resistant to lodging and the expected yield will be 30-35 q fibre/ha.
Area : West Bengal, Assam, Orissa, Tripura and Eastern Uttar Pradesh
- 2. Sonali (JRC 321):** It is a copper red pigmented variety selected from local material Hewti. Time of sowing is last week of February–mid March. The duration is 150–160 days and yield is 20–25 q fibre/ha.
Area :North Bengal, Assam, eastern Uttar Pradesh.
- 3. Shyamali (JRC 7447):** It is a full green variety with pigmentation. Optimum sowing time is 1st week of March–Mid April. Duration is 180 days and yield potential is 35–40 q of fibre/ha.
Area: Gangetic West Bengal, Orissa & Bihar.

II. *Corchorus olitorius* (Tossa Jute)

- 1. Chaitali Tossa (JRO 878):** The variety has red pigment on stem. It is a cross between JRO 620 (red pigmented) and sudan green. It has non-shattering pod. The sowing is done during 1st week of March. Duration is 150–170 days and the expected yield will be 22–32 q/ha.
Area: West Bengal, Assam, Orissa, Tripura and Eastern Uttar pradesh.
- 2. Basudev (JRO 7835):** It has green pigment on stem. Cross between sudan green × JRO 632 (green). Non shattering variety. Sowing is done during March and late sowing in May. Duration is 120–135 days and the expected yield is 28–38q/ha.
Area: West Bengal, Assam, Bihar and Eastern Uttar Pradesh.
- 3. Navin (JRO 524):** It is a high yielder than JRO 878 and JRO 7835 and quick in retting. Pods are non shattering: Plants have pigmented stem.

E. Seed and Sowing

	<i>Line sowing</i>	<i>Broadcasting</i>	<i>Spacing</i>
Olitorius jute	5 kg/ha	7 kg	25 × 5 cm
Capsularis jute	7 kg	10 kg	30 × 5 cm

F. Weed Management

Hand weeding twice at 20–25 and 35–40 DAS (or) application of pre-emergence herbicide Fluchloralin at 1.5 kg/ha followed by one hand weeding on 30–35 DAS is recommended.

G. Water Management

Water requirement is 500 mm. First irrigation immediately after sowing and second life irrigation is given. Then, subsequent irrigations are given once in 15 days.

H. Harvest

Harvesting is done from 100–110 DAS and also extended to 120–135 DAS. Jute plants are left in the field for 3–4 days for leaf shedding.

I. Yield

Fibre yield of 20–25q/ha is expected from green plant weight of 45–50 t/ha.

J. Retting

It is a process by which the fibres in the bark get loosened and separated from the woody stalk. It is a microbial process affected by various aerobic and anaerobic micro flora. The harvested bundles should be kept standing in deep water for 3–4 days before the entire bundle is steeped; later bundles should be placed side by side usually 2–3 layers and tied together and covered with aquatic weeds. The float is then weighed down with seasoned logs or kept submerged at least 10 cm below the surface of water. Retting is best done at 34°C. At the end of the 8th day onwards, reeds (stems) are to be examined. Fibre should be extracted from the retted stalks gently, keeping the stalks in water. Extraction should be done from each reed (stem) separately. Wood sticks should be avoided. The extracted fibre should be dried in mid sun over a bamboo frame for 2–3 days.

15.11 FIBRE CROPS—MINOR**1. SUNNHEMP (*Crotalaria juncea*)**

It is grown mainly in Uttar Pradesh, Madhya Pradesh, Maharashtra, Rajasthan and Orissa. It has gained importance because of increasing demand of a particular grade of fibre for manufacturing tissue paper and paper for currency as it contains high percentage of cellulose and low amount of lignin. It is indigenous to India and found throughout the plains of India.

Soil	:	Well drained loamy soils are best.
Season	:	In North India, it is grown in Kharif season and in South India, it is grown in both Kharif and rabi seasons.
Seed and sowing	:	20–25 kg/ha. Time of sowing is May–June.
Manuring	:	50 kg P ₂ O ₅ /ha as basal application is recommended.

Varieties	:	K12, M.19, M.35, Nalanda Sanni, ST-55.
Weed management	:	One weeding in early stage is enough because it grows very fast and smothers all weeds.
Water management	:	When crop sown in early month (May–June), 1–2 irrigations are given before rain start.
Harvesting	:	Harvesting is done at pod formation stage.
Yield	:	Fibre yield 8–10 q/ha.

2. Mesta (*Hibiscus Cannabinus*)

Mesta is the plant from which the fibre called Bimbli Patam jute is extracted and is an important fibre crop yielding a bast fibre of great commercial value. The fibre is some times referred to as Deccan hemp or Ambari hemp. The leaves, tops and tender branches are greatly esteemed as a cattle fodder and believed to be especially valuable for cows and buffaloes milk. The leaves and tender shoots and young fruits are also eaten by people, cooked like ordinary pot herbs or in chutneys and curries.

During 2003–04, it occupies an area of about 0.20 million ha with an annual production of about 1.08 million bale (one bale = 181 kg fibre). The productivity of mesta is 11 q/ha. The potential yield of jute is 35–40 q/ha but the actual realization is a little more than 50% of potential yield.

Mesta cannot tolerate salinity as well as acidity. It is grown as a rainfed crop in black cotton soil. The varieties comprise broadly two *viz.*, a green leaved one and a reddish leaved one in both of which the colour of the stem corresponds to the colour of the leaves. The red stemmed green veined variety was found to be the best for fibre. There is another species *Hibiscus Sabdariffa*, which has deep red almost dark flowers and capsules and which yield the fibre called *Roselle*. The fibre of mesta is rough and strong with a breaking strength estimated to be 45.4 kg. The fibres are 3 m long, bright and glossy. Though it resembles jute, it cannot stand water logging and is much used for making fishing nets, rough sack cloth and canvas.

A. Field Preparation

As the crop is grown as a mixed crop with ragi, cholam and sugarcane, there is no preparation of the field especially for this crop. The field is prepared and bring it to the fine tilth for pure crop sowing.

B. Season & Varieties

The sowing is done in the month of June–July. In any case, sowings are not earlier than May or latter than July.

<i>Hibiscus sabdariffa</i>	–	RT1, RT2, HS 4288
<i>Hibiscus cannabinas</i>	–	MT15, MT129, HC867

C. Seed Rate

About 12–17 kg/ha (as a pure crop) for Broadcasting and 10–13 kg/ha (as a pure crap) for Line sowing is recommended.

D. Spacing

30 × 15 cm

E. Fertilizer

For rainfed crop, application of 20 kg N/ha and for irrigated crop, 40 kg N/ha is recommended. It is

applied in two splits *viz.*, half as basal and another half as top-dressing around 30–35 DAS. Weeding and pest and disease management may be need based.

F. Growth and Harvest

The crop grows rapidly and begins to flower from the second month. The crop is harvested when about 50% or more plants are at flowering stage, as delayed harvesting gives a higher fibre yield but the quality becomes coarse and poor. The plants take 5½–6 months to become ready for cutting. At this stage, the stem attains a thickness of 2" in dia at the base about half that thickness along the upper portions. The plants are cut at the base and brought over to the threshing floor where they are stacked. After extracting the seeds, the stalks are taken to the retting tank or stream for preparing the fibre. The stacks are tied into small bunds and kept submerged under water. They are kept in this way for 8 days. The bast is now quite loosened from the stem and can be easily peeled off in long strips and beating the long strips in water. The clean fibre is now dried in the sun and is put up in large plaits and stored.

G. Yield

When it is grown as a pure crop, the yield of marketable fibre may amount to 450 kg/acre as a maximum. As a mixed crop, the yield is 90 kg/acre. The out turn of fibre is about 16 per cent on the weight of the dry stalks.

3. Agave (Agave Sp.)

Among the under exploited resources, 'Agave'—a fibre yielding drought tolerant plant is one which can prosper the life of the dry land farmers without any risk. In India, it is cultivated in 50,000 ha. Agave is a short-stemmed plant bearing a rosette of long erect pointed fleshy leaves. Agave is noted for its strong, coarse fibre, superior to and more flexible than Manila hemp. It is widely used for making ropes, cordage, twine, fishing nets, door mats, land rugs and the short fibres are used for making mops, brushes. The waste material left after decorticating the leaves is used for making craft paper and paperboards. The fibre also contains about 73–78% of lignified form of cellulose. Apart from these, wax from agave wastes, Hecogenin acetate, a steroid useful for the pharmaceutical industry in India is obtained from agave juice. The genus Agave has about 275 species, of which, *A. sisalana*, *A. cantala* and *A. americana* commonly occur in India. Agave blossoms only once during its lifetime and then dies. Agave plants are grown along railway line, roadsides, riverbanks and as a hedge plant in dry land areas throughout the country. Till date, it is grown in patches and as border crop in a neglected condition. The crop comes up on dry soils unsuitable for crop cultivation but grow vigorously on dry, well-drained sandy loam soils.

Nursery: Agaves are usually propagated from bulbils or suckers. Grown up suckers can be dug out and planted during rainy months. In case of bulbils, they are first sown in mother beds at close spacing (5000 bulbils per bed of 1 × 20 m). After 6 months, the seedlings are pulled out and planted in the transplanting bed of size 20 × 1 m at 500 plants. In the second stage, it is kept for three months. After 9 months from the date of bulbils sowing, suckers weighing ¼–½ kg and 9–12" heights are ready for planting.

Main field planting: In the main field, they are planted at 2 × 2 m in pits of size 30 cm³. Planting is usually carried out during the rainy seasons for better establishment, otherwise, initial watering is quite essential for establishment.

Harvesting: The leaves are ready for harvesting from 3rd year onwards. The older leaves of length not less than a metre is harvested in the 3rd year. Each plant yields 40–50 leaves/year. The life cycle of the plant is up to 18 years. The content of fibre varies with variety from 2.5%–4.5% and the highest is

reported under *A. sisalana* as 4.5%. *Agave sisalana* produces a better quality fibre than *Agave americana*. From 3rd year onwards, leaf yield of 30–40 t/acre could be harvested. Even as border crop, agave could fetch revenue of not less than Rs. 2000/acre/year from 3rd year until 8th year. From traditional hand scraping process, now we have mechanical decorticators for the extraction of fibre. The extracted fibres are washed in water, cleaned and dried and packed in bales. The precaution while fibre extraction is that it should be done on a bright sunny day and within 2 days of the harvesting of the leaves or else the quality of the fibre will be deteriorated. The fibre colour varies from mealy white to golden yellow.

15.12 BIO FUEL PLANTS

In India, nearly 63 m. ha of wasteland is available in the country, out of which 33 m. ha of wasteland have been allotted for tree plantation. Certain multipurpose bio-fuel plants can grow well in wastelands with very minimum input. Once cultivated, the crop has fifty years of life. Fruiting can take place in these plants in two years. Bio-fuel plants grown in parts of the waste land, for example, 11 m. ha, can yield a revenue of approximately Rs. 20,000 crore a year and provide employment to over 12 million people both for plantation and running of the extraction plants. It will reduce the foreign exchange outflow paid for importing crude oil, the cost of which is continuously rising in the international market. The bio-fuel is carbon mono-oxide emission free. The oil can also be used for soap and in candle industries. De-oiled cake is a raw material for composting and the plantation is also good for honey production. One time investment needed for bio-fuel plantation to production in 11 m. ha will be approximately Rs. 27,000 crores. The capital equipment and investment in plant and machinery can come from bank loans and private sector entrepreneurs. Bio-fuel plants can be grown in a number of states in the southern, western and central part of the country (Abdul Kalam, 2006).

1. *JATROPHA CURCAS*

Jatropha curcas is multipurpose non-edible oil yielding perennial shrub originated in tropical America and West Asia. It is commonly known as physic nut or purging nut. *Jatropha curcas* belongs to the family Euphorbiaceae and has the tendency to produce latex and animals do not browse the plant. This is a hardy and drought tolerant and this crop can be raised in marginal lands with lesser input. The crop can be maintained for 30 years economically. The genus *Jatropha* has 176 species and distributed throughout the world. Among them, 12 species are recorded in India. The species *Jatropha curcas* is a promising one with economic seed yield and oil recovery. The oil from *Jatropha curcas* can be used as bio-diesel blend upto 20%. However, the refined oil is a qualified neat bio-diesel. The plant flowers a year after planting and the economic yield is obtained from 4th year onwards. The farmers of southern districts suggest that this crop can be cultivated as fence crop initially in black cotton soils of southern districts under rain fed conditions.

Climate: It grows well under subtropical and tropical climates. It can tolerate extremes of temperature but not the frost.

Soil: It is grown on wide range of soils. It comes up in the marginal lands and also in problem soils (to some extent). For economic returns, soils with moderate fertility are preferred.

Variety: High yielding cultures collected from Tamil Nadu Agricultural University–TNMC–3, 4, 5, 7, 19 and 20.

Propagation: *Jatropha* is normally propagated through seeds. Well-developed plump seeds are selected for sowing, seeds are soaked in cow dung solution for 12 hours and kept under the wet gunny bags for 12 hours. Germinated seeds (2–3) are sown in poly-bags of 10 × 20 cm size filled with red soil, sand and farmyard manure in the ratio of 1:1:1 respectively. In some areas, the seeds are treated with

GA, which results in improvement of germination (45–50%) of raw or cleaned seeds. The current market price of raw seeds and cleaned seeds is Rs. 30/kg, and Rs. 40/kg respectively. Approximately, the number of seeds per kg will be around 1800.

Planting: In one acre, 1000 plants can be planted at a spacing of 2 m × 2 m. Pits of 30 × 30 cm may be dug and filled with soil and 5 kg FYM per pit before planting. For better establishment of seedlings, monsoon season may be preferred for planting (June-July, October-November).

Manures and fertilizers: From 2nd year onwards, fertilizers are applied. For one acre, 20:120:60 kg of NPK respectively should be applied during September–October. From 4th year onwards, 150 g super phosphate is recommended over and above the regular dose.

Irrigation: Irrigation is a must immediately after planting. Life irrigation should be given on 3rd day after planting. The irrigation at fortnight interval is compulsory to ensure year round production of flowers and harvest of seeds. Growing this crop under garden land condition (assured condition) or drip irrigation is good.

After cultivation: Weeding may be done as and when needed. For early flowering, GA @ 100 ppm may be sprayed. It also helps better pod development and yield.

Intercropping: Being a perennial crop, intercrops can be raised in between the rows for the first two years. Crops like tomato, bitter gourd, pumpkin, ash gourd, cucumber and black gram can be grown profitably.

Canopy management: The terminal-growing twig is to be pinched to induce secondary branches. Likewise, the secondary and tertiary branches are to be pinched or pruned at the end of first year to induce a minimum of twenty-five branches at the end of second year. Once in ten years, the plant may be cut leaving one-foot height from ground level for rejuvenation. The growth is quick and the plant will start yielding in about a year period. This will be useful to include new growth and yield stabilization there on.

Pests: Bark eaters (*Indarbella spp*) and capsule borers are the two major pests affecting the plant. They may be controlled by spraying endosulphan at 3 ml/litre of water.

Disease: Collar rot may become a problem in the beginning and be controlled by application of 1% of Bordeaux drenching.

Yield: Seedlings produce flowers 9 months after sowing. However, plants established through cuttings, produce flowers from 6th month onwards. Wherever *Jatropha* is cultivated under irrigated condition, the flowering is throughout the year. Economic yield starts from 3rd year-end. It is estimated as 3000 kg seeds/acre @ 3 kg of seeds per plant. The dried pods are collected and the seeds are separated either manually or mechanically. Seeds are dried under sunlight for four days until the moisture is brought to 6–10% before oil extraction. Oil content varies from 22–25%. The present cost of selling *jatropha* seed is Rs. 5–10/kg. If it is fixed at Rs. 25–30 per kg, the farmers will get additional income.

2. SWEET SORGHUM

Alternative uses of sorghum include commercial utilization of grain in food industry and utilization of stalk for the production of value added products like ethanol, syrup and jaggery and bioenriched baggasse as a fodder and as a base material for cogeneration. The syrup can be used as table syrup, bread species, and in salad dressing, cakes, biscuits and ice-cream topping. Utilization of sorghum grain as animal and poultry feed has dramatically increased due to the price competition from maize. Similarly, demand for industrial and potable alcohol is continuously increasing. The recent policy of Government for blending of alcohol in petrol at 5 per cent increased the demand for alternative and

commercially feasible raw materials such as sweet sorghum. Sweet sorghum has emerged as a supplementary crop to sugarcane in dry land pockets for the production of ethanol. The advantages of the crop are: (i) it can be grown with limited water and minimal inputs; (ii) it can be harvested in four months. Sweet sorghum is gaining the world attention as a promising bio-energy crop and alternative raw material for the production of alcohol. The success rate is high because of the use of existing machinery available in the sugar factories and attached distilleries. Sweet sorghum juice can be used for the production of syrup called “sorghum honey”. Farmers, in a manner similar to jaggery preparation can prepare sorghum honey. Bagasse can be enriched and sold as cattle-feed. It is also a highly suitable base material for cogeneration. Similarly, use of grain as an alternate raw material for the production of potable alcohol is promising and receiving importance for use as biofuel.

Sweet sorghum stalk is juicy and rich in fermentable sugars as high as 15–18 per cent and has potential for cane yield of 40 t/ha or more. Projected uses of sweet sorghum are production of alcohol, syrup and jaggery from the stalk juice. The recovery of alcohol in the pilot run showed 9 per cent of the juice having a brix of 12°. The various quality parameters that are determined along with the phenotypic characters are juice yield (t/ha), juice extraction (%), juice brix (%), juice pH, reducing sugars (%), non-reducing sugars (Sucrose %), commercial cane sugar (CCS) equivalents (%), and total sugars (%). These parameters play a very important role in determining the suitability of a genotype for a particular alternate use envisaged (mainly alcohol). So far no variety was released except **SSV 84 (105 days)** through All India Coordinated Sorghum Improvement Project.

Varieties: The important sweet sorghum varieties released at international level are Rio, Dale, Brandes, Theis, Rama, Vani, Ramada and Keller. BJ 248, RSSV 9, NSSV 208, NSSV 255 and RSSV 56 are the sweet sorghum cultures identified by the All India Coordinated sorghum Improvement Project at National level. Hybrid Madhura developed by Nimkar Agricultural Research Institute, Phaltan, Maharashtra is a popular hybrid in sweet sorghum. The TNAU has developed a sweet sorghum **VMS 98003** with a cane yield of 45.7 t/ha and ethanol yield of 3.6 kl/ha as a promising sweet sorghum variety for Tamil Nadu and is being tested under adaptive research trial (ART) and will be released soon. Most of these varieties mature in 100–110 days.

Climate and Soil: It can be sown during June, coinciding with the SWM, September-October during NEM with a rainfall of 500-600 mm well distributed across the growing period and also during summer with assured irrigation. The crop does not prefer high rainfall as high soil moisture or continuous heavy rain after flowering may hamper sugar increase. If irrigation is available, sowing can be advanced before June so that the crop does not face heavy rains after flowering and more so during the last half of grain maturing period. Sowing during summer season may result in low biomass and sugar yield. All soils that have medium depth (18" and above) with good drainage are suited. Depending on the soil (red, black, laterite and loamy) and its depth, water requirement may vary which in turn decide the suitability of the crop.

Seed treatment: The seeds are treated with Carbendazim (or) Thiram @ 2 g/kg of seeds. The seeds are treated with 2% KH_2PO_4 for 6 hours as pre sowing treatment under rainfed condition. Before sowing, the seeds are treated with azospirillum @ 600 gm/ha.

Seed rate and sowing: For better productivity, the optimum spacing should be 45 cm × 15 cm with a seed rate of 10 kg/ha. 3–4 seeds are dibbled in each hill/planting hole and the seedlings are to be eventually thinned to one per hill. If a planter is used, then the existing seed rate can be further reduced.

Fertilization: Recommended dose of fertilizer for sweet sorghum in soils with normal fertility level is 120 kg N, 40 kg P_2O_5 and 40 kg K_2O . Half of N and whole of P and K are applied as basal. Remaining N is to be top-dressed during 25–30 days after germination, following weeding and inter-cultivation.

Weed management: Atrazine @ 0.2 kg a.i./ha can be applied as pre-emergence herbicide at 3 DAS followed by hand weeding at 45 DAS.

Irrigation: Irrigation should be based on available soil moisture, which depends on the type of soil and the rainfall distribution. Minimum of 6–7 irrigations are required with an interval of 7–10 days.

Pest management: Major pests are sorghum shoot fly and stem borer. Shoot fly attacks soon after germination upto 30 days. Stem borer incidence may be at a later stage and continues up to maturity. Shoot fly attack is noted by dead hearts in seedlings and heavy tillering in affected plants later. Shoot fly is controlled with the application of Carbofuran 2G @ 8–10 kg ha⁻¹ during plating either along the furrow (in furrow sowing) or in shallow furrows cut on the ridge (in ridge plating). The same insecticide could be applied in leaf whorls (2–3 granules/whorl) based on the foliar injury symptoms, to prevent stem borer tunneling.

Disease Management

Downy mildew: Seed treatment with Metalaxyl at 4 g/kg of seed. Rogue out infected plants up to 45 days after sowing and spray Metalaxyl 500 g or Mancozeb 1 kg or Zineb 1 kg/ha. Spray Mancozeb 1250 g/ha after noticing the symptoms of foliar diseases, for both transplanted and direct sown crops.

Head mould: Spraying Mancozeb 1 kg/ha or Zineb 1 kg/ha or Captan 1 kg/ha + Aureofungin sol 100 g/ha may be done in case of intermittent rainfall during ear head emergence and a week later.

Sugary disease: Sowing period to be adjusted so as to prevent heading during rainy season and severe winter. Spray Ziram 1 kg/ha or Mancozeb 1 kg/ha or Zineb 1 kg/ha at emergence of ear heads (5-10% flowering stage) followed by a spray at 50% flowering and repeat the spray after a week if necessary.

Rust: Spraying Mancozeb at 1 kg/ha is done, when the disease reached grade 3 and repeated after 10 days.

Harvest: The ear head should be harvested at physiological maturity and sun dried for removing excess moisture in the grain. The green cane should be cut at the ground level and sent to the mill for crushing at the earliest (12 hours after harvest) as the sugar content decrease in progression with time. In any case, it should be crushed before 48 hrs failing which sugar content will be drastically reduced.

Varieties	SSV 84	RSSV16	NSS 104
Green cane yield (t/ha)	36.0	38.0	41.0
Grain yield (t/ha)	2.3	2.3	2.0
Juice brix	8	19	20
Jaggery yield (t/ha)	3.0	3.1	3.3
Ethanol yield (l/ha)	1851	1948	2101

Production of starch	:	592 kg/t of grain (glucose + starch × 1.11)
Glucose production	:	657 kg/t of grain
Alcohol Production	:	380 l/t of grain

3. SUGAR BEET

Sugar beet (*Beta vulgaris* Var. *Saccharifera* L.) is a biennial sugar producing tuber crop, grown in temperate countries. Now, tropical sugar beet varieties are gaining momentum in tropical and sub-

tropical countries including Tamil Nadu as a promising alternative energy crop for the production of ethanol. The ethanol can be blended with petrol or diesel to the extent of 10% and used as bio-fuel. The byproducts of sugar beet *viz.*, beet top can be used as green fodder, while pulp and filter cake from industry can be used as cattle feed. Sugar beet has now emerged as commercial field crop because of the favourable characters like (i) tropical sugarbeet varieties suitable for Tamil Nadu (ii) shorter duration of 5–6 months (iii) moderate water requirement of 80–100 cm (iv) higher sugar content of 12–15% (v) improvement of soil conditions because of tuber crop, and (vi) suitability for saline and alkali soil. Further, as the harvesting period of sugarbeet coincides with the period from March to June, the human resource of sugar factory in the off season could be efficiently utilized in the processing of sugarbeet in the sugar mills, which facilitates in continuous functioning of the sugar mills.

Variety and duration: The tropical sugar beet varieties like Pasoda, H1 0064 and Doratea etc., are suitable for cultivation in Tamil Nadu. The duration of these tropical varieties will be 5–6 months depending on variety and climatic conditions prevailing during crop growth period.

Climate and soil: Tropical sugar beet requires good sunshine during its growth period. Sugar beet can be grown during October–March with a well-distributed rainfall of 300–350 mm across the growing period. This condition favours vegetative growth and acts as a base for tuber enlargement. However, high soil moisture or continuous heavy rain may affect development of tuber and synthesis of sugar. The sugar beet crop requires an optimum temperature range of 20–25°C for germination, 30–35°C for growth and development and 25–35°C for sugar accumulation. All kinds of well drained deep soil (45 cm) with stable and porous soil structure and sandy loam to clayey loam texture are suitable. Optimum pH range is 6.5–8.0 but, it can also grow in saline and alkaline soil. The soils with good organic matter status are more favourable for sugar beet.

Season: Sugar beet is a cold weather crop season (rabi). Hence, sugar beet is sown from October to November and harvested during April–May.

Field preparation: Sugar beet being a root crop requires deep ploughing (45 cm) followed by 2–3 ploughings to obtain a good soil tilth condition for favourable seed germination and tuber development. After proper leveling to ensure adequate drainage, ridges and furrows are formed at 50 cm apart.

Seeds and sowing: To maintain the required plant population of 40,000/acre, use 2 pockets designer seeds. One pocket contains 20,000 seeds weighing 600 g. The recommended spacing is 50 × 20 cm. The designer seed is dipped at 2 cm depth on the top of the ridges at 20 cm apart at one seed per hole.

Manures and fertilizers

<i>Manures and fertilizers</i>	<i>Basal application</i>	<i>Top dressing</i>
Farm Yard Manure	10 t/acre	–
Biofertilizers		
Azospirillum	2 kg/acre (10 pockets)	–
Phosphobacteria	2 kg/acre (10 pockets)	–
Fertilizers		
Nitrogen	–	15 kg/acre each at 30 and 60 DAS
Phosphorus	24 kg/acre	–
Potassium	24 kg/acre	–

Weeding and earthing up: The crops should be maintained weed free upto 75 days. Pendimethalin at 1.5 l/acre is dissolved in 300 l of water and sprayed with hand operated sprayer on 3rd day after

sowing, followed by hand weeding on 25 and 50 DAS. The earthing up operation coincides with top dressing of N fertilizer.

Irrigation: Sugar beet is very sensitive to water stagnation at all stages of its growth. Irrigation should be based on soil type and climatic conditions. Pre-sowing irrigation is essential at the time of sowing. First irrigation is very crucial for the early establishment of the crop. For light textured sandy loam soil, irrigation once in 5–7 days and for heavy textured clay loam soil, irrigation once in 8–10 days is recommended. Light and frequent irrigation is recommended for maintaining optimum soil moisture. The irrigation may be stopped at least 2–3 weeks before harvest. At the time of harvest, if the soil is too dry and hard, it is necessary to give pre harvest irrigation for easy harvest.

Pest and diseases: The major insect pests are aphids, tobacco caterpillar and diamond back moth. To control aphids, spray neem oil 3% or dimethoate 2 ml/l with teepol. For tobacco caterpillar, spray endosulfon 2 ml/l or carbaryl 2g/l of water. The major insect pests that affect the sugar beet crop are rhizoctonia wilt, powdery mildew, cercospora leaf spot, and fusarium yellow. To control rhizoctonia wilt, spot drenching with Bordeaux mixture 1% and for fusarium wilt, drenching the soil with carbendazim @ 0.1%. To control powdery mildew, spraying of wettable powder 0.3% and for cercospora leaf spot, application of mancozeb 0.25% on 10–14 days schedule.

Harvest, yield and economics: The sugar beet matures in about 5–6 months. The yellowing of lower leaf whorls of matured plant and tuber brix reading of 15–18% indicate the maturity of tuber for harvest. The harvested tuber should be handled as gently as possible to remove soil and trash to minimize the beet breakage and bruising to get quality beet tuber. The average yield of beet tuber is 30–35 t/acre. Total cost of cultivation per acre is around Rs. 8,000–8,500 and the income will be Rs.18,000/- acre with a net income of Rs. 10,000/- acre.

15.13 GREEN MANURES AND GREEN LEAF MANURES

With the advent of high yielding crop varieties, expanded area under irrigation and greater use of fertilizers and other inputs, Asia has changed within the last 20 years from a region of food scarcity to a region of food sufficiency. Increased fertilizer use has been estimated to contribute to about one-fourth of the increased rice production. In some countries, fertilizer prices were subsidised, thereby enabling farmers to apply production-maximising doses. During the same period, use of organic manures including green manure, declined substantially. But fossil fuel-based inorganic fertilizers are becoming more expensive. Another issue of great concern is the sustainability of soil productivity as lands are intensively tilled to produce higher yields from a single crop and higher total annual yields under intensive cropping system. The soil organic matter and nitrogen levels vital to sustained crop production are often limiting in the soils of East, South and South-east of Asia. Hence, there is an urgent need to identify alternate nitrogen sources to supplement inorganic fertilizers. Occurrence of multi-nutrient deficiencies and overall decline in the productive capacity of soils under intensive fertilizers use has been widely reported. All these factors have created a renewed interest on organic manures. Green manuring is a low cost but effective technology in minimising the investment cost of fertilizers and in safeguarding the productive capacity of the soil. The practice of green manuring is as old as the art of manuring crops. The first serious test was made in 1882 at Kanpur Agricultural Station in Uttar Pradesh and was followed at Nagpur and Damraon in 1882 and 1897 respectively. The European planters of India were the pioneers in giving a systematic practice of green manuring as far back as 1890 and the coffee estates of southern India. It is a well-known fact that N, for which soils have the greatest hunger, is a costly plant nutrient. This can be cheaply obtained by the inclusion of leguminous crops in rotations and their ploughing under.

A. Definition

Crops grown for the purpose of restoring or increasing the organic matter content in the soil are called green manure crops. Their use in cropping system is called 'Green Manuring' where the crop is grown *in situ* or brought from outside and incorporated.

Green leaf manuring consists of gathering green biomass from nearby location and adding it to the soil. In both, the organic material should be worked into the soil while they are fairly young for easy and rapid decomposition. Legumes are usually utilised as green manure crops as they fix atmospheric nitrogen in the root nodules through symbiotic association with a bacterium, rhizobium and leave part of it for utilization of the companion or succeeding crop.

B. Subsidiary Object of Green Manures

(a) **Catch crops:** Legumes are inter sown in the main standing crop a little before or after harvest. With a view to utilize the nitrates that might form during the off-season or the left over moisture in the soil profile. This may otherwise be lost. Such subsidiary crops are called 'Catch Crops'. The catch crops ploughed in as green manures or grazed off. Utilizing the nitrates formed in the soil or residual moisture is a primary object of Green Manuring is only incidental.

(b) **Shade crops:** Green manure crops may be sown in young orchards with the object of shading the soil surface and preventing the rise of temperature. Otherwise the tender roots of fruit plants may be affected by the high soil temperature. In plantation crops like tea and coffee, *Gliricidia* is used as shade crop first and then incorporated as green manure.

(c) **Cover crops:** Green manure crops are sometimes grown with the object of clothing the surface with a vegetative cover especially in hill slopes during the rainy weather to avoid soil erosion and runoff. This may also done to check wind erosion. The crop chosen should be capable of covering the surface at the time of commencement of rainy or windy season. Later it is used as Green manure.

(d) **Forage crops:** Some legumes are also grown for taking a few cuttings of green fodder for cattle in every stages. For example, philippesara seeds are broadcasted in the standing rice crop (3–5 days before harvest) in coastal Andhra Pradesh. The early growth supplies fodder for cattle and the later growth is used for green manure purpose.

C. Advantages of Green Manuring

Green manuring has a positive influence on the physical and chemical properties of the soil. It helps to maintain the organic matter status of arable soils. Green manure serves as a source of food and energy for the soil microbial population, which multiplies rapidly in the presence of easily decomposable organic matter. The enhanced activities of soil organisms not only cause rapid decomposition of the green manure but also result in the release of plant nutrients in available forms of use by the crops. Green manuring improves aeration in the rice soils by stimulating the activities of surface film of algae and bacteria. Many green manure crops have additional use as sources of food, feed and fuel.

- (i) **Soil structure and tilth improvement:** Green manuring builds up soil structure and improves tilth. It promotes formation of crumps in heavy soils leading to better aeration and drainage. Depending on the amount humus formed, green manuring increases the water holding capacity of light soils. Green manure crops form a canopy cover over the soil and reduce the soil temperature and protect the soil from the erosive action of rain and water currents.
- (ii) **Fertility improvement of soils:** Green manure crops absorb nutrients from the lower layer of soils and leave them in the soil surface layer when ploughed in, for use by the succeeding crops. Green manure crops prevent leaching of nutrients to lower layers. Leguminous green manure

plants harbour nitrogen fixing bacteria rhizobia in the root nodules and fix atmospheric nitrogen. Green manure crops increase the solubility of lime phosphates, trace elements etc., through the activity of the soil microorganisms and by producing organic acids during decomposition. Single crop of green manure on an average is reported to fix 60–100 kg nitrogen/ha in single season under favourable conditions.

- (iii) **Amelioration of soil problems:** Green manuring helps to ameliorate soil problems. *Sesbania aculeata* (dhaincha), when applied to sodic soils continuously for four or five seasons, improves the permeability and helps to leach out the harmful sodic salts. The soil becomes fit for growing crops. Green leaf manure from sources such as *Argemone mexicana* and *Tamarindus indica* has a buffering effect when applied to sodic soils.
- (iv) **Improvement in crop yield and quality:** Green manuring increases the yield of crops to an extent of 15–20 per cent compared to no-green manuring. Vitamins and protein content of rice have been found to be increased by green manuring of rice crop.
- (v) **Pest control:** Certain green manure like Pongamia and Neem leaves are reported to have insect control effects.

D. Classification of Green Manure

It can be mainly classified into two groups viz., legumes and non-legumes and further sub-divided under two groups in each viz., green manure and green leaf manure.

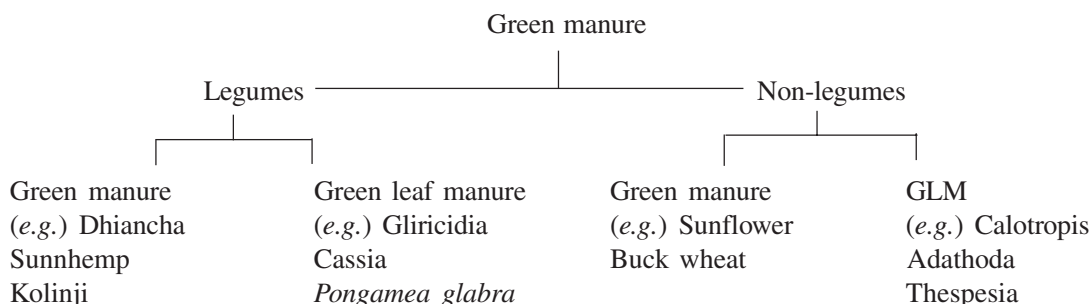

The legume and non-legume green manures are differentiated as follows:

- (i) **Legumes:** Legumes fix free nitrogen from the atmosphere. Physical condition of the soil is improved by cultivation and incorporation. They are more succulent than the non-legumes and less soil moisture is utilised for their decomposition. They serve as cover crops by their vigorous growth and weeds are smothered e.g., Clover, Dhaincha and Cowpea.
- (ii) **Non-legumes:** Free N is not fixed by non-legumes except in specific plants, which have root nodules produced by bacteria or fungi, e.g., Casuarina, Elaeagnus and Cycas. They are not as succulent as legumes and hence require more soil moisture and time for decomposition.
- (iii) **Characteristics desirable in legume green manure crops:**
- Multipurpose
 - Short duration, fast growing, and high nutrient accumulation ability
 - Tolerance for shade, flood, drought and adverse temperatures
 - Wide ecological adaptability
 - Efficiency in use of water
 - Early onset of biological nitrogen fixation
 - High N accumulation rate

- Timely release of nutrients
- Photoperiod insensitivity
- High seed production
- High seed viability
- Ease in incorporation
- Ability to cross-inoculate or responsive to inoculation
- Pest and disease resistant
- High N sinks in underground plant parts.

Leguminous green manures: Some common leguminous green manure plant species are listed below:

<i>Local name</i>	<i>Botanical name</i>
Sesbania	<i>Sesbania speciosa</i>
Dhaincha	<i>Sesbania aculeata</i>
Sunnhemp	<i>Crotalaria juncea</i>
Wild Indigo	<i>Tephrosia purpurea</i>
Pillipesara	<i>Phaseolus trilobus</i>
Cowpea	<i>Vigna unguiculata</i> , (Syn. <i>V. sinensis</i>)
Cluster bean (Guar)	<i>Cyamopsis tetragonoloba</i>
Green gram (Mung bean)	<i>Vigna radiata</i> , (Syn. <i>Phaseolus aureus</i>)
Black gram	<i>Vigna mungo</i> , (Syn. <i>Phaseolus mungo</i>)
Berseem	<i>Trifolium alexandrinum</i>
Madras Indigo	<i>Indigofera tinctoria</i>

Some of the common shrubs and trees utilised for gathering green leafy material for manuring are the following:

Cassia auriculata, *Derris indica*, *Ipomoea cornea*, *Thespesia populnea*, *Azadirachta indica*, *Glyricidia maculata*, *Leucaena leucocephala*, *Calotropis gigantea*, *Delonix regia*, *Delonix elata*, *Jatropha gossypifolia*, *Cassia tora*, *Cassia occidentalis*, *Tephrosia purpurea*, *Tephrosia candida*, *Dodonea viscosa*, *Hibiscus viscosa*, *Vitex negundo*.

Non-conventional green manures: These are leguminous or non-leguminous annuals, shrubs and trees, capable of providing large biomass and can supply considerable quantity of plant nutrients. Initial setback may be seen in crops after the incorporation of organic residues with wide C:N ratio, high lignin content which resist easy decomposition and release of higher proportion of organic acids during the decomposition process. This early adverse effect on the establishment of young seedlings might have discouraged the farmers in using those non-conventional green biomass as manures in agriculture. This could be overcome by a small extra addition of N or proper pre-treatment, with suitable microbial inoculants. The nutrient contents of some non-conventional green manure are given in Table 15.12.

Table 15.12. Nutrient Content of Non-Conventional Green Manures

S.No	Green manures	Total N (%)	C:N Ratio	Total P (%)	Total K (%)
I.	Trees (Leaves of Twigs)				
1.	<i>Azadirachta indica</i>	2.83	70:1	0.28	0.35
2.	<i>Delonix elata</i>	3.51	27:1	0.31	0.13
3.	<i>Delonix regia</i>	2.76	32:1	0.46	0.50
4.	<i>Peltophorum ferrugenum</i>	2.63	34:1	0.37	0.50
5.	<i>Cassia nigricans</i> Ca-0.88% Mg-0.34%	2.73	–	0.18	0.50
II.	Weeds				
1.	<i>Azithoda vesica</i>	1.32	60:1	0.38	0.15
2.	<i>Parthenium hysterophorus</i>	2.68	30:1	0.68	1.45
3.	<i>Ecchornia crassipes</i>	3.01	29:1	0.90	0.15
4.	<i>Trianthema portulacastrum</i>	2.64	32:1	0.43	1.30
5.	<i>Ipomea carnea</i>	2.01	43:1	0.33	0.40
6.	<i>Calotrophis gigantea</i>	2.06	64:1	0.54	0.31
7.	<i>Cassia pistula</i>	1.60	120:1	0.24	1.20

Other green manures: There is an unexploited rich source of plants, which can be used as green manure in India. One such crop is velvet beans (*Stizolobium deeringianum*). This is an important forage legume widely grown in the tropics and sub-tropics. This crop puts up vigorous growth, accumulating greater biomass and covers the ground fairly well in a short period, smothering weeds and effectively conserving soil moisture. Besides preventing soil erosion it also builds up soil fertility by adding organic matter and fixing atmospheric nitrogen in the root nodules. It is drought tolerant, grows vigorously and can thrive on diverse soil types and marginal lands and gives good yields even in less fertile soils. The leaves and vines form a good roughage. The pods and seeds have a high feeding value as a concentrate feed. The tender fruits and seeds from unripe pods can be used as vegetable. Studies conducted at the Tamil Nadu Agricultural University, Coimbatore in two seasons, revealed that it could produce a high biomass yield of 28 t/ha at 60 days after sowing when sown at a closer spacing of 30 × 20 cm. When it is sown thickly it has a potential of producing 40–45 t of green matter. The crop accumulated 255 kg N/ha at 60 days after sowing due to its vigorous growth and greater foraging for N in the soil. One constraint limiting the greater use of this green manure crop is the non-availability of good quality seeds. Velvet beans were found to have a profuse pod bearing habit and gave a high yield of 2 t/ha. Being a photosensitive crop it has to be sown at the right time to get optimum biomass and seed yield. According to studies, Velvet beans accumulated greater biomass during South-west monsoon and North-east monsoon. February was found to be the best month for sowing. Since it has multiple use, its inclusion in the cropping system will open up new possibilities.

E. Choice of Green Manure Species

Various nitrogen-fixing leguminous and non-leguminous species—particularly trees, creepers and bushes—can be used as green manures. The criterion for selection of plants as green manure is given

in Table 98. Using grain legumes for green manuring brings quick economic benefit but, as they tend to accumulate nutrients in the grain, which is then harvested, their positive effect on subsequent crop yields is usually low. Mixtures of green manure crops are often more successful than sole crops, as they are less susceptible to pest attacks and combine different characteristics needed for improving the fallow land, such as quick soil cover and deep rooting.

As legume growth depends on the presence of suitable *Rhizobium* strains, inoculation may be necessary. Plant growth and organic N₂-binding can be hindered by water stress, unfavourable pH, lack of other nutrients (particularly P, Ca, Mo and Zn) and/or Mn toxicity. Applying mineral or organic fertilisers (including rock phosphate, lime and ashes) can help to improve legume establishment. Also species in the natural vegetation should be considered for improved fallow, particularly those that are protected by local farmers, *e.g.*, *Acioa barterii*, *Chlorophora excelsa*, *Alchornea cordifolia*, *Anthonota macrophylla* and *Dialium guineense* in southern Nigeria. Also tropical grasses such as *Pennisetum purpureum*, *Panicum maximum* or *Tripsacum laxum* can produce large biomass and accumulate phosphorus and potassium more quickly than most legumes.

Table 15.13. Criteria for Selection of Plants

<i>Criteria</i>	<i>Effects</i>
High biomass production	Mobilisation of nutrients from soil into vegetation; suppression of weeds
Deep rooting system	Pumping up of weathered and/or leached nutrients from soil layers not occupied by roots of main crop
Fast initial growth	Quick soil cover for effective soil protection; suppression of weeds
More leaf than wood (low C/N ratio)	Easy decomposition of organic matter leading to enhanced availability of nutrients for succeeding crops; easy to handle during cutting and/or incorporation into the soil.
Nitrogen fixing	Increase of nitrogen availability
Good affinity with mycorrhiza	Mobilisation of phosphorus leading to improved availability for crops
Efficient water use	Possibility to grow after main cropping season on residual soil moisture or with less rainfall
Non-host for crop related pests and diseases	Decrease in pest and disease populations.
No rhizomes	Controllable growth
Easy and abundant seed formation	Propagation in farmer's fields
Useful 'by-products' (<i>e.g.</i> , fodder, wood)	Integration of animal husbandry and forestry

F. Forms of Green Manuring

Green manure crops can be planted in different combinations and configurations in time and space:

- Improved fallow, *i.e.*, replacing natural fallow vegetation with green manure crops to speed up regeneration of soil fertility and permit permanent cultivation; these green manures may be left to grow for one or several years, or only during the dry season;

- Alley cropping, a form of simultaneous fallow in which quickly growing trees, shrubs (usually legumes) or grasses are planted in rows and are regularly cut back; the pruning are used as mulch or worked into the soil in the alleys between the rows;
- Integration of trees into crop land, as is found in several traditional farming systems, *e.g.*, in West Africa (*Faidherbia albida*) and in Costa Rica, where tree legumes (usually *Erythrina poeppigiana*) growing among the crops are regularly cut for mulch material to maintain soil fertility in plots of coffee and other crops;
- Relay fallowing by sowing bush legumes among the food crops after these have established and, in the dry season, using the cut green biomass as mulch or working it into the soil; examples are *Tephrosia vogelii* in Cameroon, *Sesbania rostrata* in South-east Asia and *Mucuna pruriens* in Honduras;
- Live mulching, in which the rows of food crops are sown into a low but dense cover crop of grasses or legumes, *e.g.*, *Centrosema pubescens*, *Pueraria phaseoloides*, *Arachis prostrata*; strips of the cover crop are removed by hand or killed by herbicides when the food crops are to be sown, thus reducing soil tillage operations to zero;
- Shaded green manures (in fruit orchards, coffee plots, multistorey kitchen gardens etc.);
- Azolla and blue-green algae.

G. Agronomy of Green Manure Crops

1. *Sesbania speciosa* (*sithagathi*): It is adaptive to different soil conditions and can come up in sandy, loamy, alluvial, clayey and alkaline soils. Though the growth is very slow in the first 30–40 days, it picks up subsequently making rapid growth. It withstands salinity to some extent. It has no serious pests or diseases. The plant has greyish appearance with soft hairs on the stem and leaves. The stem is pithy, but if allowed to grow for more than four or five months, it becomes woody making it difficult to be pulled out or even to be harvested with sickle. There are different methods of growing *Sesbania speciosa* in rice field. Three or five days prior to the harvest of rice crop, seeds at 50 kg/ha are sown as broadcast. These seeds get thrust into the soil while labourers move during harvest of rice crop. With the available soil moisture, the *Sesbania* seeds germinate. This method is very easy to follow as it involves no preparatory cultivation for raising green manure crop. After ploughing the field, *Sesbania* seeds are broadcasted at 35–50 kg/ha. A good stand of crop can be obtained by irrigation. Where two crops of rice are taken, three weeks old seedlings of *Sesbania* can be grown along the borders of the field during the first crop season and utilised as green manure for the second crop. Such border planting of *Sesbania* at a spacing of 5–10 cm in one hectare will give about 5000–8000 kg of green matter for the second crop. For this purpose, at the time of raising rice nursery for the first crop, 0.75 kg of seeds of *Sesbania* may be sown in 2.5 cents of nursery. While transplanting rice seedlings, *Sesbania* seedlings are also pulled out and planted along the borders of the field.

Each plant of *Sesbania* gives about 400–600 g of seeds. For sowing one hectare for green manure purpose, 50 kg seeds will be necessary. Hence, if about 125–150 vigorous plants are left among the border plants, sufficient seeds could be obtained from these plants. The yield of green matter varies depending upon the duration of growth. A 60 days crop will yield about 10,000 kg/ha of green matter while 90, 120, 150 days crop will yield 20,000, 50,000 and 60,000 kg/ha of green matter, respectively. For one hectare of rice crop, 6,250 kg of green matter will be sufficient.

Season	Grown all seasons, March–April sowing is best
Soil	Grown in all types of soil conditions
Seed rate	30–50 kg/ha for green manure, seed purpose 15 kg/ha
Seed treatment	Mix seeds with specific rhizobium strain @ 5 pkts/ha
Spacing	Broadcasted and for seed purpose adopt 45 × 20 cm
Irrigation	Once in 15–20 days
Harvest	Incorporate the green matter 45–60 DAS and for seed, collect the seeds on 130 DAS
Yield	Green biomass-10–18 t/ha, Seed 400–600 kg/ha

2. *Sesbania aculeata* (Daincha): It is a quick growing succulent green manure crop. It adapts itself to varying conditions of soil and climate. It can be grown even under adverse conditions of drought, water logging, salinity, etc. It comes up even in alkaline soils and corrects alkalinity if grown repeatedly for four-five years. Bacterial nodules are formed in plenty on the roots. The plant has a soft stem. It makes good growth in two-four months and produces abundant green matter ranging from 10–20 t/ha, depending upon the age at harvest. Recommended seed rate is 20–25 kg/ha, though higher seed rate help in producing plants with thin stem. The stem gets woody and fibrous after three months of growth. As a pure crop, 25–30 kg/ha seeds are sown and the plants ploughed in for single crop rice. Though the initial growth is slow, it picks up fast and grows vigorously by later.

Season	Grown all seasons when sufficient moisture is available, March–April sowing is best for seeds production
Soil	Grown in all soil conditions
Seed rate	25–30 kg/ha for green manure, seed purpose 20 kg/ha
Seed treatment	Mix seeds with specific rhizobium strain @ 5 pkts/ha
Spacing	Broadcasted, for seed purpose adopt 45 × 20 cm
Irrigation	Once in 15–20 days
Harvest	Incorporate the green matter within 45–60 DAS and collect seeds from 100 DAS
Yield	Green biomass-20 t/ha, Seed-500–600 kg/ha

3. *Sesbania rostrata* (Manila agathi): It is a leguminous crop, which has nodules both on the stem and roots. It was introduced in India during 1980's from the International Rice Research Institute, Philippines. It is a tropical legume, which thrives well under flooded, and water logged conditions, producing aerial nodules on the stem. Due to its profuse stem nodulation, it gives ten times more nodules than most of the legumes. This can be grown either prior to rice crop or in between two rice crops. Though naturally propagated by seeds, seedlings and root stem cuttings can also be used as planting material. The normal seed rate is 30–40 kg/ha. To get early, uniform germination and vigorous seedlings, seeds have to be scarified with concentrated sulphuric acid for 15 minutes. Summer (April–July) is the best season for getting higher biomass and better seed production. The photosensitive nature of this crop (short day) restricts its usage during winter. Intercropping one row of 30 days old seedlings for every 1.5 metre rice could produce 3–5 t of biomass in 30 days after transplanting. Rice yields are not affected due to intercropping.

Season	Grown all seasons. February–May sowing biomass yield is more, March–May sowing is best for seeds production
Soil	Black and red soils suitable, Saline alkaline soils not suitable
Seed rate	40 kg/ha for green manure, seed purpose 7–8 kg/ha
Seed treatment	Seeds to be scarified with concentrated H ₂ SO ₄ (100 ml/kg) by soaking for 10 minutes then wash thoroughly (10–15 times). Mix seeds with specific rhizobium strain @ 5 pkts/ha
Spacing	Broadcasted, for seed purpose adopt 45 × 20 cm
Irrigation	Once in 15–20 days
Nipping	For seed purpose, it should be done 60 DAS to increase branching and seed yield
Harvest	Incorporate the green matter within 45–50 DAS and seeds can be collected from 100 DAS (3–4 harvest)
Yield	Green biomass–20 t/ha, Seed–500–600 kg/ha

4. *Crotalaria juncea* (Sunnhemp): It is a very quick growing green manure-cum-fibre crop. It comes up well in loamy and heavy soils. This crop can be cut even when it is 45 days old. It does not withstand heavy irrigation or continuous water logging. There are a number of varieties varying in duration ranging from 75–150 days. The general appearance of the crop is greyish to greenish. The tall, robust and late duration varieties are used for fibre extraction also. The seed rate is 25–40 kg/ha and the yield of green matter may vary ranging from 12,000–25,000 kg/ha depending upon the environmental conditions and duration of the crop. The further details are given in the section 15.11:

Season	Grown in all seasons, March–April sowing is best for seeds production
Soil	Loamy soils are suitable
Seed rate	25–40 kg/ha for green manure, seed purpose 20 kg/ha
Seed treatment	Mix seeds with specific rhizobium strain @ 5 pkts/ha
Spacing	Broadcasted or 30 × 10 cm, seed purpose adopt 45 × 20 cm
Irrigation	Once in 30 days
Harvest	Incorporate the green mater within 45-60 DAS and for seed production, collect the seeds from 150 DAS
Yield	Green biomass 13–15 t/ha, Seed–400 kg/ha

5. *Tephrosia purpurea* (Wild Indigo): It is a slow growing green manure crop. It is not grazed by cattle and so no protection is needed in the field. Further, if the crop is continuously raised for 2–4 seasons in the same field, it becomes self sown in the subsequent years and, thereafter, there is no need of any fresh sowing of seeds in the same field. It is suitable for light soils. It does not withstand water stagnation. It is a perennial under shrub, growing wild in sandy or gravelly wastelands. But it is grown as an annual crop for green manure purpose. It is hardy and drought resistant and suited for summer fallows. It comes up well in loamy soils and could be grown in light soils. The seeds are sown as broadcast in the standing crop of rice just a week before harvest as catch crop. The seeds have a waxy, impermeable hard seed coat and do not quickly germinate. To hasten germination, the seeds are to be pounded with sand or steeped in hot water at 55°C for 2–3 minutes. The seed rate is 25–40 kg/ha, while the green manure yield varies from 3500–6000 kg/ha.

Season	Grown all seasons, March–April is best for seeds production
Soil	Grown all soils, sandy soils are suitable
Seed rate	25–40 kg/ha for GM, seed purpose 10 kg/ha
Seed treatment	Soak the seeds in concentrated sulphuric acid (100 ml/kg seed) for 30 m and then thoroughly wash the seeds in water for 10–15 times and shade dry
Spacing	Broadcasted, for seed purpose adopt 30 × 10 cm
Irrigation	Once in 30 days
Harvest	Incorporate within 60 DAS and for seed collect from 150 DAS
Yield	Green biomass 3.5–5 t/ha, Seed–400–500 kg/ha

6. *Indigofera tinctoria*: This is a perennial shrub. It is found wild and in cultivated lands. There are two types, which closely resemble each other and are generally found grown as indigo (Madras Indigo and Bengal Indigo). The seed rate is 25–30 kg/ha and the yield of green matter varies from 10,000–12,000 kg/ha.

7. *Calopogonium mucunoides*: This is a leguminous cover crop with the ability to cover the ground within a short period. It is also a self-sown crop. The cultivation of calopogonium as a cover crop is the cheapest and most effective method to check soil erosion and the growth of obnoxious weeds in plantations of pepper, orange, coconut etc. It also enriches the soil and conserves soil moisture. It is an annual/perennial, with creeping or climbing habit. It is not grazed by cattle. The plant is capable of growing to a length of about 2.5 m in the course of about 16 weeks and to strike root at every one of nearly 25 nodes over this length, though only about 50 per cent of these nodes actually develop roots in the field. Each plant has three leader shoots and about eight main lateral shoots from each leader shoot. In addition to the large volume of leafy growth over the ground, the plants are found to develop a large volume of roots in the ground. The luxurious surface growth of the plant protects the soil from the splash effects of raindrops during the monsoon months.

The chief merit of Calopogonium as a cover crop, in addition to the ease with which it can be established in a very short period, is that it dries up during the summer months and offers no competition to the plantation crops for the limited soil moisture. The leave shed by the cover crop during the summer months provide a dry mulch which could effectively reduce soil temperature and surface evaporation during the season. Another desirable attribute of Calopogonium is that it re-establishes itself during the rainy season and covers the soil within a short period. Profuse seeding is yet another virtue of calopogonium. This results in the cover crop establishing itself every year with the summer showers from the self-sown seeds. The seed rate for establishing the cover crop in the beginning is 8–10 kg/ha and the yield of green matter is 5000 kg/ha.

8. *Phaseolus trilobus* (Pillipesara): This is a dual-purpose crop yielding good fodder for cattle and green manure for land. It is an herbaceous creeper growing into a short dense cover crop when grown thick. Though it does not produce a bulky yield, it is capable of being cut twice or thrice before being ploughed into the field. The harvested material is used as forage. Seeds are also used as a minor pulse. It comes up under varying conditions of soil but prefers loamy and clayey soils. Initially, adequate soil moisture is essential for its early growth. One or two irrigations given during its growth period will help in producing bumper harvest of forage crop. After this harvest, the crop can be ploughed into the soil. It is able to withstand drought and also excessive soil moisture. The seed rate is 20–25 kg/ha and the yield of green matter is 10,000–12,000 kg/ha.

Season	Grown in all seasons, March–April is best for seeds production
Soil	Rice fallow clay soils are suitable
Seed rate	20–25 kg/ha for green manure, seed purpose 10 kg/ha
Spacing	Broadcasted, for seed purpose adopt 30 × 10 cm
Irrigation	Once in 25–30 days
Harvest	Incorporate the green matter within 60 DAS and for seed collect the seeds from 150 DAS
Yield	Green biomass 10–12 t/ha, Seed 400–500 kg/ha

9. *Centrosema pubescens*: It serves as a cover crop as well as a good fodder crop. It is a drought tolerant legume and a self propagating crop and so it needs no replanting. It is a slow growing perennial creeper, which is hardy and aggressive in nature. It is a shade loving crop and persists in soil. It has cracked pods.

10. *Macroptilium atropurpureum* (Siratoo): It is a good cover crop. It is a highly drought resistant perennial legume. It forms a good mixture with pasture grasses. It is suitable for sandy loam to red loamy soil. It is a slow growing crop. It has prostrate stem. It sheds its leaves. It has to be replanted each year. The biomass produced by this plant is more than that of centrosema.

11. *Stylosanthes hamata*: It is used as a good soil cover and also as forage crop. It is a perennial drought resistant, spreading type. It is capable of growing on sandy soils. It is a compatible mixture with cultivated pasture grasses. It produces low biomass.

12. *Pueraria phaseoloides* (Kudzu): It is a hardy, perennial leguminous cover crop. It comes up in poor rough soils and steep slopes. It is a creeper. It has prostrate stem. It sheds its leaves in winter. It has to be replanted each year. It is a fast growing vine propagated through cuttings. It does not withstand water logging. It is superior to *Centrosema* in biomass production. It comes up in hot summer and autumn.

13. *Dolichos lab lab* var. *lignosus*: It is an excellent cover crop. It has a diffuse branching forming a dense cover. It has profuse seeding habit. It does not tolerate winter.

H. Agronomy of Green Leaf Manure Shrubs and Trees

Green leaf manuring is the application of green leaves gathered from shrubs and trees growing in waste lands to the fields where crops are to be raised. Green leafy material is gathered from all sources by farmers for manuring purpose. Different kinds of shrubs growing on tank bunds, waste lands, field bunds, garden lands, etc. are used. In addition, loppings from miscellaneous trees are also gathered for use as green leaf manure. Green leaves have the same effect as green manure on the land and the crop. The common shrubs growing in waste lands are *Cassia auriculata*, *Dodonia viscosa*, *Calotropis gigantea*, etc. Leguminous trees like *Pongamia glabra* and can be planted in waste lands, for augmenting the supply of green leaves. The trees do not require any attention after they get established and start growing. A brief description of some of the most common shrubs and trees utilised for the collection of green leafy material is given below.

1. *Glyricidia* (*Glyricidia maculata* syn. *G. sepium*): It is a shrub type of plant that comes up well in moist situations. Under favourable conditions of soil and climate, it takes up a tree habit. It is a quick growing tree and often used for shade and green leaf manure in tea, coffee and cocoa plantations. It can be planted on alternate field bunds of wetland, 1–2 m apart, or as a thick hedge by close planting in 3–4 at 0.5 m spacing or along field border as tall shrubs giving support to the fence line or along farm roads on both sides for the production of green leaf. For green leaf purposes, the shrub could be kept low by pruning

or lopping at convenient heights. The shrub is pruned 2–3 times a year and it withstands repeated lopping. It has no root effect on the crops grown by the side. When the shrubs are regularly lopped, the height is restricted to 2–3 m and they do not affect the growth of cultivated crops with their shade effect.

Glyricidia can be propagated by planting stem cuttings or seedlings raised in nurseries. The establishment of seedling is better compared to stem cutting. The seeds are sown in well prepared nursery and the seedlings transplanted when they are about 30–60 days old. Within two years after planting, the plants are ready for lopping. Each plant gives 5–10 kg of green leaves annually. When the individual rice fields are about 0.1 ha each, 375–400 plants can be planted on the bunds of one hectare of land and this will produce 2500–3500 kg of green leaves annually.

2. *Ipomoea cornea*: It is a quick growing, profusely branching, and highly drought resistant weed. It gives abundant green leafy material in short time. It is multiplied by means of mature stem cuttings. Stem cuttings of about 0.3 m long with three or four nodes and axillary buds are planted at a distance of 1–2 m all along the wide field bunds, irrigation channels and fences. As many as 1800–2000 cuttings can be accommodated in one ha as border planting and two to three loppings can be taken in a year. Each plant will give about 5 to 7 kg of green matter per lopping.

3. *Cassia auriculata*: It is a very common plant, found coming up in waste lands, hill slopes, plain sea shores, etc., almost in the wild condition. It is a hardy plant. The plant is propagated through seeds. The seeds get dispersed and plants grow naturally without any efforts. When the plants start to flower in off-season, they are cut and applied to the fields.

4. *Derris indica* (Syn. *Pongamia glabra*): It is a leguminous, moderate sized ever green tree. It grows in coastal forests, on river banks and on tank bunds mostly along streams, wastelands and road sides. Trees are established by means of planting two to three months old seedlings, 4 to 5 m apart. Loppings may be taken once or twice a year. A tree yields approximately 100 to 150 kg of green material per lopping.

5. *Azadirachta indica* (Neem): It is a profusely branching, large ever-green tree and gives plenty of foliage. It comes up in all types of soil. The trees are grown along field borders, rivers banks, roads, waste lands and also in garden lands and homestead gardens. Trees are established by planting seedling at a spacing of 5–6 m. One or two loppings in a Year are taken in favourable seasons, each lopping weighing about 150–200 kg of green matter.

6. *Thespesia populnea*: It is also an ever-green tree, which thrives in all types of soils. The trees are grown in garden land areas, gardens and also in waste lands. A spacing of 4–5 m is adopted. It is propagated by stem cuttings. It establishes very quickly and produces a number of branches. Two or three lopping of green leaves are taken in a year during favourable seasons. A tree will give as much as 100–150 kg of green matter per lopping.

7. *Delonix elata* (Vadanarayan): It is a tropical ever green tree, which thrives in all types of soils. Generally, it is propagated by stem cuttings. In a year, 2–3 lopping can be taken during favourable seasons. It has some medicinal values.

I. Rhizobial Inoculation

The leguminous green manure crops have the ability to fix gaseous nitrogen from the air with the aid of rhizobia, which live in nodules on the roots of the legume plants. The bacteria live symbiotically in nodules, with the plants providing food and energy for the organisms, which, in turn, benefit the host plant by fixing nitrogen from the air. Consequent on this symbiotic relationship the leguminous plants succeed in enriching the soil nitrogen status only in the presence of proper nodule bacteria. As many soils do not contain the appropriate strains of bacteria, it becomes necessary to inoculate the legume seeds with the specific strains of rhizobia in order to ensure better growth of the host plant and effective

nitrogen fixation by the nodule organisms. Without *Rhizobium* bacteria, the leguminous green manure crops may deplete the soil of nitrogen like any other non-leguminous plants instead of replenishing the soil nitrogen store. Among the root nodule bacteria (rhizobia), there are several types and strains, which are specific for different legumes. For best results, appropriate strains of *Rhizobium* bacteria for each legume should be present. It may be that poor and ineffective forms of many of the strains of rhizobia are present in normal soils. They may produce nodules that provide little or no nitrogen. Therefore, it becomes necessary to inoculate the legume seeds with beneficial strains of proper root nodule bacteria. The process of nitrogen fixation begins as soon as or shortly after the formation of nodules, and continues as long as the nodules remain firm and healthy. The maximum nitrogen fixation is found to take place at the flowering stage of the host plant. The percentage of nitrogen progressively decreases as the seed formation proceeds and the nitrogen percentage in the nodules approximates to that of the root by the time the seed is ripened.

Conditions for fixation of nitrogen

- The presence of appropriate strains of rhizobia in the soil
- The level of moisture in the soil
- The initial nitrogen level in the soil
- The presence of available plant nutrients in the soil
- The pH of the soil (pH 5–9 is conducive for N fixation)
- The stage of growth and conditions of the green manure crop

When the soil is rich in nitrogen, the root nodule bacteria do not fix nitrogen from air but feed on the soil nitrogen. The legumes, they, act just like any other non-leguminous crops. Under such circumstances, it would be advantageous to grow cereals along with legumes in the ratio of 1:3 so that the cereals would be depleting the soil of its nitrogen and the legume would thrive on the atmospheric nitrogen. The requirements for successful nitrogen fixation are proper inoculation with efficient strains of bacteria, adequate supply of available phosphate, lime and moisture, good drainage and a neutral soil reaction.

Bacterial inoculation of legumes: It has been proved that there is a definite increase in the total nitrogen content of legumes when inoculated with specific bacterial culture of the right type and efficiency. Inoculation is the process of mixing the most appropriate bacteria with seeds at sowing time so that maximum benefits are derived from the symbiotic association of plant and bacteria. Inoculation is generally done by treating the specific pure cultures with seeds by using gum or rice kanji. The following indications normally reflect the need for rhizobial inoculation:

- When the growth of a recent crop of legume was poor.
- When the recently grown legume crop had sparse nodulation on the tap root and upper side roots with widely scattered small nodules on the lower regions of root system.
- When legume is being grown on land that is poor due to lack of care or unfavourable natural conditions.
- The uses of inoculation could be summed up as follows:
 - It prevents nitrogen starvation
 - It lessens the dependence of legumes on soil nitrogen
 - It improves the quality of crop
 - It increases crop yield
 - It ensures a nitrogen rich leguminous green manure crop.

J. Stage of Incorporation

When the green manure crops are grown and incorporated in the same field, the best stage of incorporation is the flowering stage of the crop. However, when green-leaf manuring is practised by bringing in the green plants grown elsewhere, no definite stage can be fixed as the green leaf manuring is controlled by many other factors. But it can be said that the plants used for green leaf manuring should be incorporated into the soil before they mature or attain the woody nature. Plants of very young nature also should not be incorporated as they will very easily decompose leaving little residue in the soil. Woody plants will decompose very slowly. Hence, the best stage for incorporation of plants is either at the flowering stage or before they attain the woody texture.

K. Time of Incorporation

The success of green manuring depends on the correct time of trampling green matter into the soil and giving sufficient interval before sowing or planting the crop. The manure, being a bulky one is usually applied as basal dressing before the main crop is raised in the field. In our country, except for some perennial crops like coconut, fruits and some plantation crops like tea and coffee, green manure is applied as basal dressing. After incorporation, sufficient time is allowed for decomposition to take place and only after this, the main crop is sown or planted. However, the time will vary according to the crop and other agronomic practices followed. For example, for sugarcane, sunnhemp is grown along with the main sugarcane crop and the green manure crop is incorporated after about 40 to 50 days growth at the time of earthing up. In the case of plantation crops, green manure grown in the same field or brought from outside is incorporated for the decomposition in the field. Usually about six to eight weeks time is found to be sufficient for the decomposition.

L. Method of Application of Green Manure

The method of application varies from place to place depending upon other agronomic practices followed. In the case of green manuring, when plants are grown in the same field where they are to be incorporated, the plants are cut at the proper stage to the ground level, placed in the furrows and covered by the next furrow. With the availability of labour saving implements like green manure trampler, the plants are trampled by working the implement and later on levelling the field. This practice is possible where rice is transplanted. In broadcast crop, a suitable modification is necessary and usually both green manure crops is incorporated during the first weeding. In case of green leaf manuring, the plants brought from outside source are spread over the field and trampled in by the use of implements or by human labour. In some cases, as in the green manuring of sugarcane, the incorporation is done during inter cultivation operation.

M. Decomposition of Green Manures

The green manure applied to soil undergoes a series of chemical changes and only after these biochemical changes the nutrients contained in the plants become available and the Humus is synthesized. Hence, as in the case of any other bulky organic manure, the nutrients become available slowly and steadily for a prolonged period of time. The green matter applied to the soil is acted upon by many types of micro organisms such as bacteria, fungi, actinomycetes and macro organisms like protozoa, worms and insect larvae and several end products and intermediate products are formed during the decomposition. The type of decomposition and the products formed are found to be controlled by the following important factors:

Organisms present: The type and nature of micro organisms whether fungi or bacteria, aerobic or anaerobic, autotrophic or heterotrophic organisms, will decide the type of decomposition.

Temperature: Optimum temperature of about 30–35°C is necessary for the normal decomposition processes and the rate of decomposition will be modified at low or high temperature.

Aeration: The various stages of the decomposition process are decided by the presence or absence of air. Hence, there is aerobic decomposition in the presence of air and anaerobic decomposition in the absence of air.

Moisture supply: The moisture content of the green matter and the soil decide the rate and type of decomposition. Optimum moisture is necessary for the normal rate of decomposition. In low moisture supply, decomposition will be slowed down.

Soil factors: The various physical, chemical and biological properties of the soil will influence the rate and type of decomposition. In general, the decomposition will be rapid in a fertile soil than in a non-fertile soil.

Nature of green manure: The composition of the green manure, its age, maturity, etc. will also influence the rate and type of decomposition. The young plants will decompose more rapidly than well-matured plants. Similarly plants having greater amount of nitrogen will decompose more rapidly than those having higher content of carbon compounds. Putting all the above influencing factors together, the decomposition can be broadly studied under two categories *viz.*, aerobic decomposition and anaerobic decomposition or purification

(i) **Aerobic decomposition:** The plant material incorporated into the soil is made up of numerous compounds. But, for studying the decomposition processes the various compounds can be roughly brought under three groups: (1) Carbon compounds consisting of carbohydrates, fats, oils, organic acids, lignin and other cyclic organic compounds; (2) Nitrogen compounds consisting of proteins, amino acids and other non-protein nitrogenous substances, and (3) Mineral salts. In this process of decomposition, the most important deciding factor is the aeration in the soil and sufficient quantity of air is always necessary for the normal rate of aerobic decomposition.

Changes in the carbon compounds: The various carbon compounds are attacked by the organisms and all of them are found to be converted finally to carbon dioxide and water. For example, if glucose is attacked by the aerobic bacteria, carbon dioxide and water are produced.

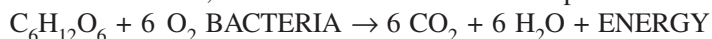

In the same way, if starch, cellulose, and hemicellulose are present, they will be converted finally to carbon dioxide and water. This conversion is found to be performed by a group of bacteria, fungi and actinomycetes capable of living only under aerated condition. But the various organisms capable of decomposing the carbonaceous material require sufficient quantity of energy and nutrients. They find sufficient energy from the decomposition of carbohydrates but there may be insufficiency of nitrogen and phosphorus and in such cases, nitrogen and phosphorus should be added to favour all the activities of the organisms. In the case of young plants there may be sufficient quantities of nutrients and hence the rate of decomposition of carbonaceous material will be carbon dioxide and water but this conversion is not so quick and simple as seen from the reaction.

Changes in nitrogen compounds: Proteins constitute the major nitrogenous compounds in the plant material. When protein undergoes decomposition, it is first hydrolysed by proteolytic enzymes produced by micro organisms to polypeptides, amino acids and other nitrogen derivatives. These are further acted upon and ammonia is formed. The ammonia produced does not accumulate in the soil except under anaerobic condition, but under aerobic nature, it is rapidly oxidized by the nitrifying bacteria to nitrate. Some of the ammonia may also be consumed by the micro organisms. In addition to the protein the other nitrogenous compounds like urea, purine bases, lecithin, choline, cyanamide, alkaloids etc., are decomposed by a great variety of micro organisms.

Changes in nitrogen compounds

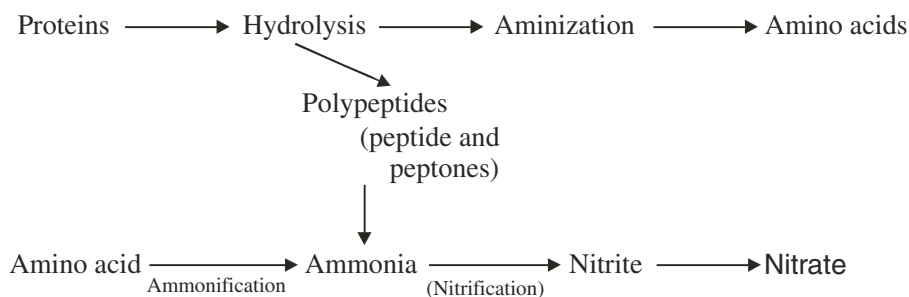

Therefore, in the aerobic decomposition, the steps are aminization, ammonification and nitrification and the end product is nitrate, though there is some utilization of nitrogen by the micro organisms to synthesize their body protein.

Changes in the mineral constituents: The various mineral constituents like those of phosphorus, potassium, calcium, magnesium, etc. which are found in the plant in the organic form and to some extent in inorganic form are converted to more soluble forms and they become readily available to the plant.

Summarizing the aerobic decomposition, the carbon compounds are finally converted to carbon dioxide and water, the nitrogen compounds finally to nitrates, the mineral constituents into more soluble forms and there is synthesis of humus. Humus is nothing but the ligno-protein complex formed by the combination of the microbial protein and the lignin present in plants. Lignin is resistant to microbial decomposition and in the presence of microbial protein present in the body of the micro organisms they unite together forming the more persistent material called humus. This is the type of decomposition taking place when green manure is applied to aerated soils (garden lands and dry lands).

(ii) **Anaerobic decomposition-** This is found to take place in soils, which are poorly aerated, or under waterlogged conditions. Under these circumstances only the organisms capable of thriving in the absence of oxygen will develop and they will decompose the various constituents present in the plant body.

(a) **Changes to carbon compounds:** The various compounds are attacked and converted to methane, various organic acids, alcohols and carbon dioxide. For example, if glucose is attacked by anaerobic bacteria and fungi, lactic acid, alcohol, butyric acid and fumaric acid are produced.

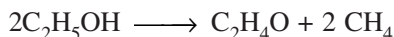
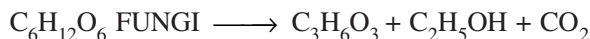
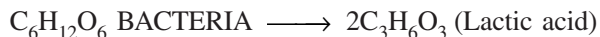

Hence, all the non-nitrogenous compounds are finally found to be converted to the above mentioned products.

(b) **Changes in the nitrogenous compounds:** Here also the proteins, on hydrolysis by the various hydrolytic enzymes produced by the various micro-organisms are converted to polypeptides,

peptides and peptones and finally to amino acids. The amino acids are further converted to ammonia and along with the ammonia, various amines and mercaptans are also produced and these are responsible for the putrefactive odour. Hence, the anaerobic decomposition is also sometimes referred to a putrefaction. The end product is ammonia but in some cases, it may be further converted to gaseous nitrogen, which may be lost to the atmosphere.

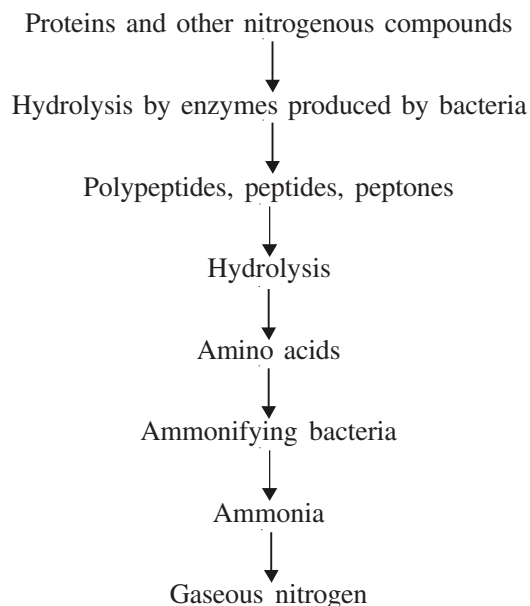

With regard to mineral constituents, they are converted into more soluble forms as in the case of aerobic decomposition. So in the anaerobic decomposition, the carbon compounds are converted to methane, carbon dioxide, organic acids, the nitrogen compounds into ammonia and gaseous nitrogen and there is the formation of humus to some extent.

Carbon nitrogen ratio on decomposition process: Carbon nitrogen ratio is the relative proportion by weight or organic carbon to nitrogen, in the soil or any organic matter. The number obtained by dividing the percentage of organic carbon by the percentage of nitrogen is usually referred to as carbon-nitrogen (C:N) ratio. Carbon-nitrogen ratio is of fundamental and practical importance in understanding the mineralization of the organic matter. It is a well established fact that the C:N ratio exerts a marked influence upon the mineralization of carbon or nitrogen of the green matter, both under aerobic and anaerobic conditions. Only green matter with C:N ratio of 30:1 or lower will decompose in the normal manner. Materials with a very wide ratio do not decompose rapidly as the nitrogen contained in the green matter is not sufficient for the microbial activity and materials with very narrow ratio decompose more rapidly as excess nitrogen is available for the microbial activity. This is due to the fact that the various micro organisms taking part in the decomposition process require carbon for their energy and nitrogen for the synthesis of their protoplasm. Hence, in the presence of more carbon (wide C:N ratio) more energy giving material will be available for the micro organisms and thus the increased activity of the organisms will utilize all the nitrogen. Once the available nitrogen is exhausted, the micro organisms will become inactive and decomposition rate will be retarded. In contrast, when proportionate amounts of both carbon and nitrogen are available, the mineralization will proceed in a normal way.

Mature plants have a very wide C:N ratio of 50:1. In such cases, the carbon, when mineralized, gives out energy, which is utilized by the various micro organisms. With the availability of more energy,

the organisms utilize all the available nitrogen present in the soil and plant material. Thus the entire nitrogen will be left to be mineralized and thus the wide ratio in the beginning will be narrowed down and when this type of green matter is added to the soil, it will be acted only by the carbon mineralizing organisms. When green matter with very narrow ratio, below 20:1, is applied to the soils, the availability of nitrogen will be more due to more mineralization of nitrogen. However, in all cases of plant materials, finally the C:N ratio will be brought to about 10:1, which is said to be an equilibrium stage. Succulent and leafy portions of green manure, when applied, decompose very quickly (in about a week time), and behave almost like inorganic fertilizer. In contrast, when matured and woody plants are used, much time is taken for the decomposition, and the nutrients are released very slowly as in the case of other bulky organic manures. Thus, the C:N ratio is an useful indicator by which the decomposition process, the release of nutrients and other biochemical reactions connected with mineralization can be well understood.

N. Farmer Acceptance of Green Manuring

If green manure crops are not associated with a direct increase in income, farmers are not likely to be interested in them. It is, therefore, important that green manuring raises the farmer's income not only indirectly by improving soil fertility but also directly, (e.g., by yielding by-products of economic importance such as fuel, stakes for climbing plants, food, fodder and local medicines). All forms of sown fallow demand a great deal of labour. Even more important can be the point in time when this labour is needed. If this coincides with other farm activities that cannot be delayed and improved fallow is not likely to be accepted by the farmers. Where forms of alley cropping are practised, farmers often prefer to plant the green manure crops in a looser configuration than the recommended model. Two leguminous plants, which show great promise as green manure, are velvet bean (*Mucuna pruriens*) and sunnhemp (*Crotalaria juncea*, *C. ochroleuca*).

O. Limitations in Raising Green Manure Crops

Though there are several advantages of green manuring, it is not being practised on a large scale by the farmers due to certain limitations.

- Non-availability of water resources may restrict raising of green manure crops.
- Non-availability of good quality seeds poses a problem.
- Allotment of 6–8 weeks exclusively for growing a green manure crop is not preferred by farmers in intensive cropping system.
- In North India, where rice is grown after a wheat crop, the farmers are not able to carry out field operations in the peak summer months of May and June.
- As the benefits of green manuring are not as spectacular as those usually derives from direct application of inorganic fertilisers, farmers are not convinced about the usefulness of green manuring.
- Sensitivity of certain leguminous green manure crops to photoperiodism is a constraint.
- Vegetative growth is regarded by early flowering during a short, dry season, resulting in less biomass production.
- A green manure crop may compete for time, labour and water, the cost of which must be balanced against the cost of inorganic fertilisers.
- Poor germination of certain green manure seeds is also a problem.
- Incorporation of green manure crops under certain situations may be difficult and costly.

15.14 FORAGE CROPS AND GRASSES

The term forages or forage crops denote plants either cultivated or wild that are used as stock feed for domestic animals, which are allowed to graze or fed with cut grasses in stalls. Forage crops include pasture (which is used for grazing animals) straw, haulms, foliage of trees and shrubs. Forages account for 4.4% of total arable land in the country. Cereal fodders/forages belong to family Poaceae and legumes belong to family Fabaceae. Although forages and fodder crops are synonyms, yet often latter is termed to the cultivated crops like cereals and legumes. The term fodder is generally applied to non-traditional forage crops used for livestock feed *e.g.*, maize, sorghum, bajra, guar etc. are primarily the grain crops, but also raised as soiling crop (greed fodder, which is cut and fed to cattle). The gap of demand and supply of forages needs to be bridged by maximizing forage production by the following ways;

- In space and time (intensification)
- Identifying new avenues of forage production
- Integration of forage crops in existing cropping
- Utilization of marginal, submarginal degraded and problem land for forage production through pastures, and sylvipasture.

	<i>Green fodder</i>	<i>Dry forage</i>
Estimated forage production	513 m.t	400 m.t.
Actual requirement	1083 m.t	676 m.t.

1. FORAGE CROPS

Forage crops are divided into six groups.

1. Grass fodder	<ul style="list-style-type: none"> • Hybrid cumbu Napier grass or Elephant grass • Guinea grass (Perennial) • Para (water) grass or buffalo grass • Kolukattai grass/Blou buffel grass
2. Cereal fodder (Annual)	<ol style="list-style-type: none"> 1. Summer Cereal fodder <ul style="list-style-type: none"> • Sorghum • Bajra • Maize • Teosinte 2. Winter cereal fodder: Oats <ul style="list-style-type: none"> • Annual summer fodder – Cowpea • Annual winter fodder – Berseem • Perennial summer fodder – Desmanthus, Stylosanthus • Perennial winter legume – Lucerne
3. Legume fodder	
4. Tree leaf fodder	Subabul (Lucaena) <i>Acacia sp.</i> (Velvel, Karuvel) Agathi
5. Dry fodder	Sorghum, cumbu, rice, maize, ragi straw
6. Miscellaneous	Most farm products except straw and hays–cane tops, fodder amaranthus and number of non-conventional fodder and feed.

A. Toxic Constituents in Forages

- (i) **Hydrocyanic acid (HCN) poisoning:** It causes sudden death with in 1–2 hours. Ruminants are more susceptible than horse and pigs.

Etiology: It is found in sorghum, cyanodon, Johnson grass and Sudan grass. Young leaves contain more than 500 ppm.

Critical level: Less than 20 mg HCN/100 gram of feed material (< 200 ppm).

Control: To avoid HCN poisoning, harvesting for fodder at heading stage/50% flowering, drying or haymaking is recommended.

- (ii) **Nitrate poisoning:** Forage that accumulated more than 1.5% of NO₃ (on dry matter basis are classified as potentially toxic).

Causes: Salivation, teeth grinding, high pulse rate, abdominal pain, difficult breathing and finally death of ruminants.

Etiology: Found in immature green oats, hybrid cumbu napier grass, rye, para grass etc.

Management practices:

- Irrigation management is important to prevent long spell of drought
- Dilution of high NO₃ water and cattle shed washings are necessary
- Avoid 'N' fertilizer application particularly during drought period
- Cutting may be delayed and allow over maturity
- Application of FYM/Compost is recommended

- (iii) **Oxalates:** Oxalic acid present in napier grass and rice straw (1.5–1.6%). Young leaves of bajra contain more oxalic acid than matured leaves. Young leaves contain up to 7%. Toxic limit is 3% only.

Symptom: It causes negative 'Ca' balance. Precipitation of calcium in the blood is possible. It impairs P, Mg and Na nutrition.

Management:

- Ensiling or hay making the napier grass is important
- Combining with legume fodder is important
- Supplemental with chalk or superannuated limewater at 1.0 lit/animal may be given along with drinking water.

- (iv) **Mimosine:** A toxic amino acid found in subabul and *Mimosa pudica*. Critical level is < 0.75%.

Symptoms: Infertility, goiter, low birth weight and death of newborn.

Control: Mixing with other cereal forages/feeding 1% FeSO₄ in the diet/supplemented with Iron.

- (v) **Saponins:** Biologically active glycosides of steroid rich in lucerne, berseem-bloating in ruminants. To avoid, feeding dry roughage prior to feeding and spraying oil are recommended.

- (vi) **Tanins:** Sorghum, Subabul, Acacia reduce digestibility of protein.

2. FORAGE GRASSES

- | | | |
|--|---|--------------------------------|
| • Napier or Elephant grass | : | <i>Pennisetum glaucum</i> |
| • Guinea grass | : | <i>Panicum maximum</i> |
| • Water or Para grass or Buffalo grass | : | <i>Brachiaria mutica</i> |
| • Blou Buffel grass (Neelakollukattai) | : | <i>Cenchrus glaucus</i> |
| • Dennanath grass | : | <i>Pennisetum pedicellatum</i> |

15.14.1 Forage Crops

15.14.1.1 Grass Fodder (Perennial)

1. Napier grass-cumber napier (*P. glaucum*)

It is a tall growing (200–300 cm) erect, stout, deep-rooted perennial hybrid grass derived from *P. glaucum* × *P. purpureum*. The crude protein content is 10.1%.

Origin: Native of Rhodesia and South Africa.

Distribution: It is widely distributed in tropical and subtropical regions of Asia, Africa, Southern Europe and America. In India, it is grown in Punjab, Uttar Pradesh, Haryana, Gujarat, Madhya Pradesh, Bihar, Orissa and West Bengal.

Climate: It grows well under warm tropical conditions.

Soil: Loamy soil with good drainage is good. It can withstand in saline soils to some extent.

Season: It is cultivated throughout the year under irrigation.

Varieties:

BN 2	– Green fodder yield of 250 t/ha/year
NB21	– 225 t/ha/year
CO1	– 250–300 t/ha/year
CO2	– 350–385 t/ha/year
CO3	– 380–400 t/ha; higher foliage, low oxalic acid content (2.8–2.9%) Non-lodging, profuse tillering, more leafy.

Seeds: It is multiplied by vegetative propagation by two noded stem cutting or by root slips. For sole crop: 40,000 slips or stem cuttings/ha. For inter cropping with one row of Desmanthus: 30,000 slips/ha.

Field preparation: The field is ploughed with Iron plough 2–3 times to obtain good tilth. Ridges and furrows are formed using ridge plough (Ridger), 6 m long and 50 cm apart.

FYM: 25 t/ha of FYM/compost is applied and incorporated.

Fertilizer application: It is applied as per soil test recommendation. If it is not possible, blanket recommendation of 50:50:40 of NPK kg/ha is followed. Full dose of NPK is applied before planting by opening furrow 5 cm deep on the side of the ridges and cover.

Transplanting: Irrigate through furrows and plant one rooted slip per hole at a depth of 3–5 cm on the side of the ridges. A spacing of 50 × 50 cm with 40,000 slips/ha is maintained. As a mixed crop, 3 rows of cumber napier hybrid and one row of desmanthus can be raised to increase the nutrient value. The following inter cropping systems are suggested:

- CNH + desmanthus at 3:1 ratio
- CNH + lucerne + oat
- CNH + velvet beans
- CNH + cowpea + berseem

Water Management: Life irrigation on 3rd day is given and thereafter once in 10 days. Sewage or wastewater can also be used for irrigation.

After cultivation: Hand weeding and hoeing is done on 30 DAP (days after planting). Thinning and gap filling is done to maintain plant population. Earthing up is done once after 3 cuts and remove dried leaves once a year.

Harvest: First harvest is on 60 DAP and subsequent harvests at interval of 45 days.

Top dressing: After each harvest, 100 kg N/ha is applied.

Points to be remembered

Quartering has to be done every year or whenever the clumps become unwidely and large. Wherever necessary to countermand the ill effects of oxalates in this grass, the following steps are suggested:

- Feeding 5 kg of leguminous fodder/day/animal along with these grasses.
- Provide calcium, bone meal or mineral mixture to the animal, or
- Giving daily half litre of superannuated clear lime water along with the drinking water or sprinkling the water on the seed.

Green fodder yield: 380 t/ha/year.

2. Guinea grass (*Panicum maximum*)

It is a tall growing, vigorous, tufted perennial grass. Guinea grass is a high tillering grass and produces more number of leaves. It is easily digestible and high yielding (250–280 t/ha). It can be grown as mixed crop with desmanthus (Velimasal). It comes up well under coconut garden and it is not toxic to any animals. It is rich in crude protein (10%), Ca (0.56%) and P (0.33%). The cropping systems like guinea grass + cowpea, guinea grass + velvet bean, guinea grass + lucerne, guinea grass + berseem, guinea grass + desmodium, guinea grass + stylosanthus and guinea grass + rice bean are recommended/ followed.

Origin: Tropical and subtropical Africa.

Propagation: It can be propagated either by rooted slips or by seeds (mostly). Germination of fresh seed is low, but can be increased by storing the seed in dry condition for 6 months.

Variety: CO1.

Soil and climate: All type of soils with good drainage is preferred. But, loamy soil is highly preferred for guinea grass. It can be cultivated in wide range of climate (from tropical to subtropical and spread even to humid tropics and subtropics).

Season:

Irrigated: Throughout the year

Rainfed: Monsoon season (June-July to Sep.–Oct.)

Field preparation: 25 t FYM/ha is applied as basal. Ploughing once with Iron plough and twice with country plough is done. Ridges and furrows are formed at 50 cm apart.

Manures: NPK should be applied as per the STL recommendation. If it is not followed, blanket recommendation of NPK at 50:50:40 kg/ha is followed at the time of planting.

Seeds and Sowing: The seed rate is 2.5 kg/ha or number of rooted slips required is 40,000/ha. The rooted slips are planted at 3 cm depth on the side of ridges adopting 50 × 50 cm spacing.

After cultivation: Hoeing and weeding is done on 30th day. Thinning and gap filling is done to maintain spacing. Earthing up is done once after three cuts. Dried tillers are removed once in a year.

Irrigation: Irrigation is given at the time of planting/sowing, followed by life irrigation on 3rd day. Thereafter, irrigation is given once in 10 days or as required.

Harvest: First cut is done at 80 DAP and subsequent cuts may be done once in 45 days.

Green fodder yield: 250-280 t/ha/year.

Top dressing: After each harvest, 50 kg N/ha is applied.

3. Para grass–*Brachiaria mutica* (water grass or buffalo grass)

It is a perennial grass and grows to a height of 2.5 m. It grows on moist soils and withstands prolonged flooding or water logging. The crude protein content is 6.9%. The cropping systems like para grass +

cowpea, para grass + velvet bean, para grass + berseem, para grass + lucerne and para grass + rice bean are followed:

Origin: Tropical Africa and Tropical South America.

Season: It is cultivated throughout the year under irrigated conditions.

Soil: It can be grown in all type of soils.

Field preparation: Same as in guinea grass.

Manuring: Application of FYM or compost at 25 t/ha and NPK at 20:40:0 kg/ha is recommended as basal prior to planting. 20 kg N/ha is applied after each cutting.

Seeds and sowing: Ridges and furrows are formed at 50 cm apart. It is propagated by stem cuttings. Number of rooted slips required for planting one ha is 40,000/ha.

Spacing: 50 × 50 cm. Plant to a depth of 3 cm on the side of ridges.

After cultivation and Irrigation: similar to that of guinea grass.

Harvest: First cut is done at 60 DAP and subsequent cuts may be done once in 45 days.

Green fodder yield: 200–240 t/ha/year.

4. *Blou buffel grass (Cenchrus glaucus)*

It is a promising green grass, which performs well in dry lands under rainfed conditions. Two species namely *C. ciliaris* (white kollukottai) and *C. setigerus* (black) are two commonly grown species, but are low yielding. *C. glaucus* (Neela Kollukattai) is the type, which yields better than other two species. It is a perennial pasture grass and easily digestible. It comes well in arid and semi arid tropical climate with long dry spell. It is highly drought resistant. It contains 9.06% protein and 0.59% Ca. It is best suited for hay or silage making. Intercropping with *Stylosanthus* at 3:1 ratio or *Clitoria* or *Sirato* or *Desmanthus* will help to improve fodder quality.

Origin: Northeast Africa and India.

Variety: CO1.

Season: It is cultivated under rainfed conditions in SWM (June-July) or NEM (September–October)

Soil: Well drained soil with high calcium or calcareous soil is good.

Field preparation: The field is ploughed twice or thrice to obtain good tilth.

Seeds and sowing: Seed rate is 6–8 kg/ha.

Spacing: 50 × 30 cm

Manuring: Application of FYM 12.5 t/ha and NPK at 25:40:20 kg/ha as basal is recommended.

Top dressing: After each cut, if sufficient moisture is available 'N' at 25 kg/ha should be applied.

Seeds and sowing: Seeds are to be sown at a shallow depth (1 cm) and cover with soil. Care is to be taken for the seeds, *i.e.*, seeds are mixed with soil and used to avoid blown away by wind while sowing.

After cultivation: One hand weeding is done on 30 DAS.

Harvest: First cut is done on 70–75 DAP and subsequent 4–6 cuts in a year depending on the growth.

Yield: Pure crop yield will be 40 t/ha/year in 4–6 cuts.

15.14.1.2 Cereal Forage Crops

1. Fodder sorghum (*Sorghum bicolor*)

It is a favourite fodder in many parts of the country. It comes up well under tropical or subtropical climate. To improve the nutritive value, it should be grown mixed with leguminous fodder crops like

cowpea, cluster bean, green gram etc. Crude protein content is 9.2–9.8%. It is used as green fodder and stover for silage and haymaking. It is an excellent silage crop. Since it contains HCN, it should be harvested at 50% flowering.

Origin: Africa.

Season: It is cultivated both under irrigated conditions (January to February and April to May in all districts) and rainfed conditions (June–July and September–October).

Varieties:

Irrigated – CO11 (37 t/ha), CO27 (44 t/ha)
Rainfed – K7 (33 t/ha), CO27

Soil: It can be grown in all soils, but loamy soils with good drainage are best suited.

Field preparation: The field is ploughed once with Iron plough and twice with country plough for rainfed crop. Field should be prepared in advance taking advantage of early showers. FYM @12.5 t/ha is applied and incorporated. Application of 10 pockets of Azospirillum (2 kg/ha) for irrigated crop is recommended.

Ridges and furrows of 6 m long and 30 cm apart are formed and irrigation channels across the furrows using a ridge are formed. If ridges and furrows are not made, beds of 20 m² depending on the availability of water are formed.

Fertilizer: For irrigated crop, fertilizer dose of 60:40:20 kg N, P, K kg/ha is recommended. Application of 30:40:20 kg N, P, K kg/ha is done as basal. Top dressing of 30 kg N is done on 30 DAS. For rainfed crop, application of 40:20:0 kg N, P, K kg/ha as basal is recommended.

Seed rate: The seed rate for irrigated crop is 40 kg/ha and 75 kg/ha for rainfed crop. The seeds are treated with 3 pockets of Azospirillum (600 g/ha).

Spacing: 30 × 15 cm is recommended for both rainfed and irrigated crops. For irrigated crop, the seeds are sown to a depth of 3 cm and cover the seeds. For rainfed crop, seed drill is used for sowing at 5 cm depth or country plough (pre monsoon sowing) and sowing is done behind the country plough.

Water management: For irrigated crop, irrigation is given immediately after sowing. Life irrigation is given on 3rd day and there after once in 10 days.

Weed management: First weeding is done on 20 DAS and second weeding on 30–40 DAS if necessary. Along with hand weeding, thinning and gap filling is done, maintaining the spacing of 15 cm between plants.

Harvesting: If it is a single cut, it should be harvested at 60–65 days (50% flowering) and if it is a multicut variety, the first cut is at 60 DAS and a second cut 40 days after first cut. The yield in first cut will be 45 t/ha (green) and 25 t/ha (green) in second cut.

2. Fodder maize (*Zea mays*)

It is a quick growing, emerging fodder and is well suited to wide of range of climate. It has no HCN content. High yield and digestibility will be obtained, when it is harvested at 50% flowering–dough stage. It is highly palatable and nutritious and suitable for high altitude.

Origin: Africa.

Season: It can be cultivated throughout the year for irrigated crop. It is cultivated in kharif season under rainfed conditions.

Varieties/Hybrid:	<i>African Tall</i>	<i>Ganga-5</i>
Green fodder yield (t/ha)	42	34
Crude protein (%)	9.8	10.6

Field preparation: Field preparation is similar to fodder sorghum.

Soil: All soils with good drainage are good. Ridges and furrows are formed 6 m long and 30 cm apart or beds are formed depending on the availability of water.

Manuring: FYM/compost at 25 t/ha is applied and fertilizer dose of 60:40:20 kg NPK/ha is followed and applied as given below:

	N	P	K (kg/ha)
Basal	30:	40:	20
Top dress on 30 DAS	30:	–	–

Seed and sowing: The seed rate is 40 kg/ha and one seed is dibbled in the row to a depth of 4 cm. The recommended spacing is 30 × 15 cm. The seeds are treated with 3 pockets of (600 g) *Azospirillum inoculant* before sowing.

Weed management: Hand weeding is done on 20th day and subsequent weeding if necessary.

Water management: For irrigated crop, irrigation is given immediately after sowing. Life irrigation is given on 3rd day and there after once in 10 days.

Harvesting: The crop is harvested when the cob is in the milling stage (50% flowering to dough stage).

Yield: Green fodder yield is 40-45 t/ha. When mixed with cowpea, fodder quality will be best.

3. Fodder cumbu/Bajra (*Pennisetum glaucum*)

It is a high yielding, sweet stemmed, high tillering, short duration, fast growing, drought resistant and non-lodging fodder. At any stage, it can be cut and fed to animals (free of toxic). As a rainy season crop, it is grown in well drained light soils of Tamil Nadu, Andhra Pradesh and Punjab. It is one of the quick growing crops and it responds to multicut. Hence, it has to be cut before flowering stage, so that 2–3 harvests can be taken. The fodder is not as palatable as that of sorghum or maize. But variety CO 8 is palatable and sweet and it contains high protein of 12.56%.

Origin: Africa.

Variety: CO 8.

Seed rate: 10 kg/ha.

Spacing: 30 × 10 cm.

Manuring: FYM at 25 t/ha is applied as basal and NPK requirement is 50:40:20 kg/ha respectively. 25:40:20 kg NPK/ha is applied as basal prior to sowing and the remaining 25 kg N as top dressing on 25 DAS.

Seed and sowing: The seeds are sown to a depth of 2-3 cm and covered or the seeds are broadcasted and covered with country plough. It can be intercropped with fodder cowpea to improve the fodder quality.

Hand weeding: Hand weeding is done on 20 DAS and subsequent weeding may be done if necessary.

Irrigation: Irrigation is given immediately after sowing. Life irrigation is given on 3rd day and there after once in 10 days.

Harvest: First cut is on 40–45 DAS (at boot leaf stage) and 3–5 cuts can be taken.

Yield: Yield is 30–35 t/ha/cut.

4. Teosinite (*Euchlaena mexicana*)

'This is relative to maize (monocious) and introduced from Central America. It is a tall, succulent annual growing to a height of 1.8-3.6 m in large clumps with numerous branching tillers. The leaves are 90 cm long and 5.0–7.5 cm broad. It was first introduced to India in 1881. It is unaffected by any serious

pests or diseases. The seeds are about 8 mm long, somewhat angular and vary in colour from dark brown to creamy white. It is also used for hay and silage making. In Punjab, it is recommended for growing during fodder scarcity months of May–June and October–November.

Climate: It is a tropical crop and it can be grown in warm humid regions with annual rainfall of >1000 mm.

Soil: It needs rich well-drained loamy soil for best growth.

Season: It is usually grown in kharif season. Best time of sowing in north India is June 25th to July 15th. It is also grown in rabi season.

Sowing: Seed rate is 40 kg/ha. Sowing is done either by broadcast or by drilling, adopting 30 cm row spacing.

Manuring: Application of 12.5 t/ha of FYM and NPK at 20:40:40 kg/ha is recommended as basal before sowing.

After cultivation: It requires more water compared to maize and 4–5 irrigations are given. One weeding may be done if necessary.

Harvest: The crop is harvested at 110–120 days. Sometimes second cut may be done after 6–7 weeks after first harvest. Fodder yield is 40–50 t/ha.

5. Oats: Winter cereal fodder: The details are given in the Chapter 15 Section 15.2.

15.14.1.3 Legume Forages

Fodder legumes are also referred as masals. They have immense value in animal nutrition, because of their higher protein content (19–24%), vitamin's specific minerals like phosphorus, calcium etc. Legume forages are near equal to concentrates and are likely to be substituted for the latter. The legume forage crops are short duration in nature and raised as catch crop in between two crops. It improves soil fertility by way of 'N' fixation and is suitable for inter or mixed cropping. It is raised for dual purpose (green manure and fodder value) e.g., Sunnhemp and berseem. It will increase intake of fodder by improving fodder availability and capable of replacing concentrates in animal rations and save feeding costs.

In India, important leguminous forage crops are:

- Annual–summer growing – Cowpea and *Stylosanthus hamata*
- Annual–winter growing – Berseem and Lentil
- Perennial – Desmanthus, Lucerne, *S. Scabra* and *S. hamata*

1. Cowpea (*Vigna unguiculata*)

It has 19% crude protein and 2.13% Ca. It is grown both in irrigated and rain fed conditions. It comes well under shade condition. Cowpea is mixed or intercropped with sorghum/maize or cumbu that will help to improve fodder yield as well as quality.

Origin: India.

Variety: CO5 (only for fodder purpose).

Season: It can be grown throughout the year under Irrigated conditions and during September–October under rainfed conditions.

Soil: All soil types with good drainage.

Field preparation: The field is ploughed 2 or 3 times and ridges and furrows are formed at 6 m long and 30 cm apart or beds of 20 m² are formed.

Manuring: Application of FYM or compost at 25 t/ha and NPK at 25:40:20 kg/ha is recommended. Band application prior to sowing is preferred.

Seed rate: 40 kg/ha.

Spacing: 30 × 10 cm.

Seed treatment: The seeds are treated with Rhizobium (3 Pockets) before sowing.

Sowing: The seeds are sown to a depth of 3 cm on the side of the ridges.

After cultivation: Hoeing and weeding is done on 20 DAS. Subsequent weeding may be done if required.

Irrigation: Irrigation is given immediately after sowing. Life irrigation is given on 3rd day and there after once in 10 days.

Harvest: Harvest is done on 50–55 days (50% flowering).

Green fodder yield: 20–25 t/ha.

2. Berseem or Egyptian clover (*Trifolium alexandrinum*)

In India, it is an important rabi forage crop in Punjab, Haryana, Delhi, Rajasthan, Gujarat and Uttar Pradesh. It is a winter forage crop and very good fodder for milch animals and horses. It has 20% crude protein/70% dry matter digestibility and rich in Ca and P. It is used as green manure growing berseem decrease bulk density and better soil aggregation can be achieved.

Origin: Indigenous to Egypt and introduced to India (1904).

Climate: Berseem requires dry and cool climate. When the temperature goes around 30–33°C, regrowth after cutting is not possible. It cannot withstand drought and frost. It cannot be grown in damp and heavy rainfall areas.

Soil: It can be grown in all type of soils except sandy soils. Well-drained medium loam soils rich in 'P' and calcium is good. It performs well in acid soil.

Field preparations: The field is ploughed once with iron plough and thrice with country plough and makes it to fine tilth. Ridges and furrows or beds are formed.

Varieties:

Diploid:

(i) Mescari (C.10)–6.0–7.0 t/ha. It is cultivated in Punjab, Haryana and Himachal Pradesh.

(ii) Berseem Ludhiana 1: (BL.1).

Tetraploid: It is a winter hardy and quick growing, very leafy and succulent. However regrowth after cutting is not possible if temperature goes > 27°C. *e.g.*, Pusa Giant (winter hardy and frost resistant) can yield 10–15% more than Mescari.

Manuring: Apply FYM 15 t/ha and NPK: 25:60:0 kg/ha as basal.

Seeds and sowing: Seed rate is 20–25 kg/ha. For late/early sowing, the seed rate is 30–35 kg/ha. The seeds are treated with rhizobium treatment.

Time of sowing: Best time of sowing is first fortnight of October. For better growth and yield, diploid and tetraploid varieties should be mixed with 1:1 or 2:1 ratio.

Sowing: The seeds are broadcasted and covered. For getting higher yield of good quality fodder, 1.8 kg of mustard seed is mixed with full rate of berseem seed.

Irrigation: Irrigation is given immediately after sowing. Life irrigation is given on 3rd day and there after once in 15–20 days.

Weed control: Pre plant incorporation or pre-emergence application of Basalin at 1.0 lit/ha in 500 lit of water is recommended.

Harvesting: First cut is done on 60 DAS. Subsequent cuttings may be done at 25–35 days interval depending on vegetable growth. After two cuttings, the crop may be allowed for seed production.

Yield: 8–11 t/ha of green fodder with 18–20% of Dry matter.

3. Hedge lucerne (*Desmathus virgatus*) Velimasal

It is a perennial fodder legume and it can withstand repeated cuttings. It is well suited for growing as mixed crop with cumbu napier hybrids. It contains 19.2% crude protein, 27% dry matter and there is no toxic principles.

Origin: South America.

Season: Irrigated crop can be cultivated through out the year and rainfed crop is raised during June–October.

Soils: All types of soils.

Field preparations: The field is ploughed once with iron plough and thrice with country plough and makes it to fine tilth. Ridges and furrows are formed at 50 cm apart.

Manuring: Application of 12.5 t FYM/ha as basal along with NPK at 10:60:30 kg/ha is recommended. Seed treatment is done with rhizobium (3 pockets/ha).

Seed rate: 20 kg/ha.

Spacing: 50 cm × solid sowing.

Sowing: The seeds are soaked in hot water for 4 minutes (80°C) and then soaked in cold water overnight. Deep sowing will result in lower germination. hence, shallow sowing to a depth of 1.0–1.5 cm is recommended.

Irrigation: Irrigation is given immediately after sowing. Life irrigation is given on 3rd day and there after once in a week.

After cultivations: Hoeing and weeding is done on 30 DAS. Thereafter, hand weeding is done after each cut.

Harvest: First cut is done on 90 DAS at 50 cm height and, subsequent cut may be done at an interval of 40 days.

Green fodder yield: 125 t/ha.

4. Stylosanthes (Muyal Masal or Stylo)

Stylos are drought resistant pasture legumes coming up well in areas receiving a minimum rainfall of 450–840 mm annually. These can be grown in a wide range of soil. Crude protein content ranges from 15–18% and it is well suited for inter cropping or mixed cropping with guinea grass.

Origin: South America.

Varieties: *Stylosanthes hamata* (perennial) and *Stylosanthus scabra* (perennial).

Season: Irrigated crop can be cultivated through out the year and rainfed crop is raised during June–July/September–October.

Field preparation: The field is ploughed 2–3 times to obtain good tilth.

Manuring: Application of FYM or compost at 10 t/ha and NPK at 20:60:15 kg/ha as basal is recommended.

Seed rate: 10 kg/ha.

Spacing: 30 × 15 cm.

Sowing: The seeds are soaked in hot water for 4 minutes (80°C) and then soaked in cold water overnight. Deep sowing will result in lower germination. Hence, shallow sowing to a depth of 1 cm is recommended.

After cultivation: Weeding is done at 25 DAS.

Irrigation: For Irrigated crop, irrigation is given immediately after sowing. Life irrigation is given on 3rd day and there after once in 7–10 days interval.

Harvest: First cut is done on 75th day (at flowering) and subsequent cut may be done depending upon the growth.

Green fodder yield: Irrigated crop can yield up to 50 t/ha. In first year, yield will be poor. Second and subsequent years, the yield will go up to 30–35 t/ha.

5. Lucerne or Alfalfa–*Medicago sativa* (Kudirai masal)

It is a perennial leguminous plant. Being a deep rooted crop, it extracts water from deeper zone. It contains higher crude protein (20–24%) with 72% digestibility and 1.5% Ca and 0.2% P. It is rich in vitamin A, B and D. Lucerne crop supplies green fodder for a long period (November to June) (for 3–4 years from the same field). It is cultivated in USA, Canada, Argentina and India. In India, it is mostly grown in irrigated areas of Punjab, Haryana, Uttar Pradesh, Gujarat, Maharashtra and Tamil Nadu.

Origin: South-west Asia.

Climate: It thrives best under dry and sunny condition. It can be grown even up to 2500 m altitude. It can withstand fairly low temperature.

Soil: Loamy soil with good drainage is highly preferred.

Season: Under irrigated condition, it can be grown throughout the year and middle of October is the best time of sowing.

Varieties: CO1, IGFRI.112 (for all areas), Anand 2, 3 and Anand 1 (for hill areas).

Manures: Application of FYM or compost at 25 t/ha and NPK at 25:120:40 kg/ha is recommended. Band placement is preferred prior to planting.

Seed rate: 15–20 kg/ha.

Spacing: 25 cm × solid line.

Sowing: The seeds are treated with rhizobium (3 pockets). Sowing at 2 cm depth on the sides of the ridges or above the fertilizer band is good.

After Cultivation: Hand weeding is done on 20 DAS, followed by thinning and gap filling. Subsequent weeding may be done if necessary.

Irrigation: Irrigation is given immediately after sowing. Life irrigation is given on 3rd day and thereafter once in a week.

Harvest: First cut is done on 60 DAS and subsequent cut at 25–30 days interval.

Green fodder yield: 80–100 t/ha (in 12–13 cuts).

Seed yield: 150–200 kg/ha.

15.14.1.4 Fodder Trees

Fodder trees provide nutritious top feed in the form of legumes and pods rich in proteins and minerals to livestock. They provide variety of products such as fuel, timber, fiber, human food, medicine etc. and they provide shade for grazing animals. Fodder trees are the source of organic matter to soil and increase soil N besides improving soil structure. The fodder trees can serve as fence/hedge and as windbreak. They prevent soil erosion and conserve soil moisture and provide shade for shade loving plants. Tree fodders increase the yield and improve the quality of grasses. The important fodder trees are *Acacia sp* (velvel, karuvel etc.), Agathi, sithagathi and subabul (*Leucaena leucocephala*).

1. Subabul/Soundal (*Leucaena leucocephala*)

Leaves and pods are nutritious. It contains high crude protein (26%) and 45% digestibility. Crude fibre content is very low and it can withstand drought. It is a quick growing and fixes atmospheric 'N'.

Variety: CO 1.

Season: It is grown during June–July under irrigated conditions, and during September–October under rainfed conditions.

Soil: Soil with high Ca and P is preferred.

Field preparation: The field is ploughed 2-3 times and ridges and furrows are formed at 100 cm spacing.

Manuring: Application of FYM or compost at 25 t/ha and NPK at 10:60:30 kg/ha is recommended as basal for irrigated crop and for rainfed crop, ½ the dose of NPK may be applied.

Seed rate: 10 kg/ha

Spacing: 100 × 30 cm

Seed treatment: The seeds are soaked in hot water (80°C) for 5 minutes and then soak over night in cold water.

Irrigation: For better establishment, the soil should be sufficiently moist for 5–6 months. In summer, irrigation once in 6 weeks is adequate.

Harvest: For irrigated crop, first cut is done 6 months after sowing and subsequent cut at 45–60 days interval and for rainfed crop, first cut is 2 years after sowing and subsequent cut at 60–80 days interval.

Green fodder yield: Irrigated-75–100 t/ha and rain fed-40t/ha

2. *Acacia* sp. (Velvel, Karuvel) *Acacia nilotica*

In English, it is called as Indian gum Arabic tree and in Tamil, it is known as Karu velam. In Hindi, it is called as Babul. It belongs to *Mimosae* family.

Utilization: Leaves and pods are widely used as fodder. It is an extremely valuable source of fuel wood and charcoal of excellent quality. General utility of timbers is for construction of carts, wheels, agricultural tools and implements, doors, windows, mine props, fencing materials etc. Bark is one of the best tanning materials of Northern India. Babul gum is used in inks, paints, matches and confectionery.

Distribution: Babul is indigenous to the Western part of the India–Gangetic plains and the Northern part of Deccan plateau, including Andhra Pradesh, Maharashtra, Rajasthan and Gujarat. It is widely planted, or self-sown throughout the hot regions of India, viz., Punjab, Haryana, Uttar Pradesh, Madhya Pradesh and Karnataka. It is an important constituent of southern dry mixed deciduous tropical forests and Northern and Southern tropical thorn forests of India; at an elevation range of 200–500 m. The tree varies much in size, remaining little more than a shrub in some localities, and in others attaining a height of 50–60 ft. or even more, and occasionally a girth of 8–10 ft.

Phenology: The young leaves appear from March to May, the old leaves commencing to fall before they appear. Flowering is most general in the rainy season, from June to September, but trees may be found with flowers as late as December or January. The time of fruit ripening varies according to locality, but is usually from April to June. It is drought-resistant; frost-tender. It is strong light-demander. Its coppicing power is very variable, generally poor.

Climate and Soil: *A. nilotica* can grow on a variety of soils, provided sufficient moisture is available. It prefers well-drained fresh alluvial sandy loam soil in riverain tracts, though it can grow on clay and black cotton soil also. It can withstand mild soil salinity provided sufficient moisture is available. In its natural habitat, average rainfall is 400–1500 mm; fairly drought resistant, but thrives best in areas with 500–1250 mm.

Nursery techniques: Babul seedlings are raised in polythene bags (5 cm × 22 cm, 150–200 gauge). Treated seeds are sown, about 1.5 cm deep, 2–3 seeds in each bag in February–March (or May, for freshly collected seed) and regularly watered and weeded. Excessive watering should be avoided; shading is necessary to avoid surface cracking.

Planting: Seedlings are fit for planting in July–August of the same year (when 3–4 months old). For obtaining bigger plants, seeds are sown in June–July in bigger bags and one year old seedlings can be planted. It's rotation is 30 years for timber and 15–20 years for tannin; it yields 23.02 m³ wood per ha at the age of 30 years and 8–10 t of pods per ha.

15.14.2 Pasture Management

Pastures are the grasslands where domestic animals are allowed to roam around and graze for themselves. Hence, pastures may be of two types viz., 1. natural pastures, and 2. seeded pastures. Native pastures are highly degraded ones. The improvement and management involves a set of technical and social interventions. The important technical interventions are:

- (i) **Identification and introduction of suitable grass and legume species:** Suitable pasture species for drought prone areas are given below:

Pasture species	Soil type	Seed rate (kg/ha)	Dry forage yield (t/ha)
Sewan grass (<i>Lasiurus indicus</i>)	Light soil	3–5	3.5 t/ha
Marvel grass (<i>Dicanthium annulatum</i>)	Medium to heavy soil	4–5	2.5 t/ha
Buffel grass (<i>Cenchrus ciliaris</i>)	Vertisols	5–6	4.0 t/ha
Dinanath grass (<i>Pennisetum pedicellatum</i>)	Vertisols–All types	8–9	3.0 t/ha
Perennial legumes			
Stylo. <i>Stylosanthus hamata</i>	Light to	5–7	3.5 t/ha
<i>S. scabra</i>	Medium soil	4–6	2.5 t/ha
Siratro: <i>Macroptilium atropurpureus</i>	Light to Medium soil	7–8	2.8 t/ha

- (ii) **Improved moisture conservation:** Forming contour furrows (60 cm wide and 22 cm deep) at a distance of 8–10 m across the slope of the grassland increase forage production of perennial grass by 130% over non furrowed grass lands.
- (iii) **Using suitable establishment techniques:**
- Reseeding:** Due to poor germination of seeds of Sewan and Marvel grass, the sowing of mixture of seeds of *Cenchrus* species and Sewan grass is found advantage for large scale development of pasture in arid regions like Rajasthan.
 - Transplanting:** The establishment of Sewan grass and Marvel grass is found more assured by transplanting of rooted slips, or seedlings compared to direct seeding.
 - Dry seeding:** *Cenchrus ciliaris* seeds sown in dry soil before on set of rain give 36% higher forage yield over monsoon sowing.
 - Pelleting forage seeds for higher seed germinations:** Pellets are prepared by mixing grass seeds with cow dung, clay and sand in proportions of 1:1:3:1 using sufficient quantity of water for preparing round pellets of size of about 0.5 cm diameter.

- (iv) **Fertilization in pasturelands:** Application of fertilizers to pasture grasses increase the forage yield as well as seed yield. Application of 20 kg N to *Cenchrus* pastures results in 83% increase in dry forage yield. In well rainfall distributed area, application of NPK at 40:20:0 is recommended. For stylo, application of “P” at 30 kg/ha is recommended. The protein content of fertilized pastures was higher than that of unfertilized ones.
- (v) **Regulating the grazing pressure and using an optimum stocking rate:** The access of live-stock to pastures should be controlled, so that grazing pressure could be managed.

Carrying Capacity: The native pasture can carry only 2 sheep/ha. But improved pasture can carry up to 6 sheep/ha in a continuous grazing system. The quality of pasture can be evaluated in terms of number of lambing and lamb weight at birth. The improved pastures produced more number of lambs (2.78) than natural pastures (1.56), because of better quality of forages.

- (vi) **Rotational grazing:** It is one in which the pastureland is divided into number of compartments. The sheeps are allowed to graze first in one compartment. After completion of grazing in the first compartment, the sheeps are allowed to graze in the second compartment and then in third compartment. This is recommended for the grassland having annual grass species. But this system requires additional investments. This system has several advantages.
- There is no wastage compared to continuous grazing.
 - The pastures get enough regrowth periods.
- (vii) **Increasing the grazing period through introduction of top feed tree species:** A major short-coming of most of common pastures is lack of production during hot summer lean period. A traditional way to over come this is to use tree leaf fodder during this period. In the pasturelands, lot of trees is growing. If these are replaced with top feed species that would prolong the grazing period and improve carrying capacity of pasture.

Top feed trees suited for sylvipastoral system

1. Semi arid regions:
 - (a) *Acacia senegal*
 - (b) *Acacia aneura*
 - (c) *Acacia nilotica*
 - (d) *Leucaena (Subabul)*
 2. Arid regions:
 - (a) *Prosopis cineraria*
 - (b) *Zizyphus sp*
 - (c) *Acacia tortilis*
 - (d) *Acacia senegal*
- (viii) **Improving the quality of fodder by inclusion of legume pasture** - With availability of high fodder yielding varieties of season-bound and perennial fodder crops, there is a glut/abundance of fodder availability during peak-periods of growth (rainy season/monsoon season) and scarcity during other periods. The best way to regulate the supply of palatable and nutritive fodder during the lean period of October and November and May to July is to conserve the surplus fodder in the form of 1. Hay (Hay making) 2. Silage (silage making).

I. Hay Making: Hay can be defined as the conversion of green forage into dry form without affecting quality of original material. It is the most common, easy and safe method of preserving the excess green fodder (grasses) for long time. The quality of hay largely depends on the (a) species (b) the stage of harvesting, and (c) freedom from moulds and bacteria.

A. Steps for making hay

- Good quality hay is prepared by adopting the following procedure:
- Quality of hay mainly depends on the stage of harvest: The fodder crops namely cowpea, velvet bean, guar, moth bean, jowar, bajra, teosinte and oats should be cut at flowering stage for hay making.
- Pasture and cultivated grasses are cut at 50% flowering or slightly earlier to prevent the lignifications of cellulose, losses of protein and palatability.
- Lucerne and Berseem are cut for hay making at 30–40 days interval.
- The fodder crop should not be harvested immediately after irrigation. They should be harvested in the afternoon and before irrigation.
- Though the fodder species may be dried as such in the field itself, the best quality hay is made by chaffing into small pieces by hand driven machine or with a power driven chaff. Either chaffed or unchaffed material is spread evenly in layers and is turned 2–3 times daily. In the evening, half dried material is raked and collected or heaped in the form of cone so as to prevent exposure of the material to dew fall at night. On the second day, the material is again spread evenly after the dew has disappeared. The material is turned frequently depending on the climatic conditions. During summer, the hay of lucerne, cowpea, berseem etc., may preferably be made in shade so that bleaching action may be reduced to the minimum.
- The hay made by adopting above steps and possessing about 15% moisture is finally transported to the hay-barn. It should retain green colour, good aroma and flavour.
- It should be preferably stored at low temperature and humidity so as to prevent the losses owing to oxidations of carbohydrates. For rainy seasons, hay curing sheds are recommended.
- In order to minimize the space for storage and for effective long term storage, the hay is turned into bales of suitable sizes with manually operated or power driven hay-bales.

B. Losses of fodder quality

- Shattering of leaves (mostly in legumes)
- Fermentation—Normal loss is about 6% of dry matter
- Oxidation leads to loss of carotenes
- Leaching—Loss of protein, N free extract minerals and vitamins. Thereby crude protein content increases and digestibility decreases.

C. Methods of haymaking

- (i) **Hay curing structures:** In some countries, haymaking is done in hay barns, which are specially designed structures in which hot air is circulated for drying the material quickly. However, in India, the most prevalent systems are as follows:
- (ii) **Fence method:** In this method, fodders are cut and spread evenly and thinly over the fences of the paddocks or fields or specially erected fences. This method helps to dry the material quickly and turning of the material after every 2 or 3 hours daily can be avoided.
- (iii) **Tripod method:** In this system, tripods of convenient heights are erected by using local materials *e.g.*, wood or galvanized iron poles. In between these poles, horizontal supports are erected to increase the carrying capacity. Unchapped fodders are dried in the manner described under the fence method.
- (iv) **Gable shaped structure:** The gable shaped structures is made by using galvanized woven-wire fencing material of desired width and angle iron poles. The fencing material is fixed in such a way as to provide a slopping support and good ventilation for quick drying. This system also

permits the excessive shedding of leafy material with less handling unlike the ordinary ground method. The structure can be made economical further by using netted ropes of medium diameter and wooden poles.

- (v) **Hay curing shades:** Hay curing shades of convenient size of 18 m × 9 m × 3 m with a slanting rod supported by pillars are constructed with corrugated asbestos. Chain like fencing of 5 cm × 5 cm mesh and 1–1.2 m in width is arranged length wise in a 4 or 5 tier system. These types of sheds are good for making hay during the monsoon and summer. The cost is further reduced by thatching the roof and by using wooden poles for support.
- (vi) **Ground method:** In this method, the chaffed or unchaffed material is thinly and evenly spread over a pucca floor so as to prevent soiling. The material is turned 2 or 3 times daily till it dries completely.

15.14.3 Silage Making

Silage is a product obtained by packing fresh fodder in a suitable container (Silo) and allowing it to ferment under anaerobic conditions with out undergoing much loss of nutrients. Fermentation under anaerobic condition preserves the nutritive value and enhances the keeping quality of the fodder. The process of conserving the green fodder in this way is termed as 'Ensiling'.

A. Qualities of good silage

- A good silage should be greenish or yellowish brown, with pleasant odour, possess high acid content (pH ranges from 3.5–4.2).
- Silage having acidic taste and odour, being free from butyric acid, moulds with ammonical "N" (less than 10% of the total nitrogen).

B. Crops suited for silage making

Generally, the fodder crops rich in soluble carbohydrates and low to medium in protein content are ideally suited for silage making. High content of soluble carbohydrates provides excellent growth medium for the anaerobic bacteria to form abundant acids, which increases the keeping quality of the silage. Maize, Jowar, Bajra, Guinea grass, Para grass and Napier grass are highly suitable for making good quality silage. On the other hand, leguminous fodders, which normally have high moisture and high crude protein and low soluble carbohydrates, are not considered fit for silage making.

C. Types of silos

- (i) **Tower silos:** They are permanent type and are costly. They are constructed above the ground level in the form of cylindrical towers. The diameter and height vary according to the needs. The loss of dry matter in such silos is 5–10% only.
- (ii) **Bunker silos:** These silos are constructed on the surface of the ground. They should always built on firm soils having good surface and subsurface drainage.
- (iii) **Pit or Trench silos:** Pit silos are less costly than tower silos and are widely adopted for silage making. Pits of desired sizes are dug according to the availability of green fodder. Pits silos are not suited to the areas where there is higher water table.

D. Making silage

A pit size of 20' × 20' × 20' is sufficient for 50–55 t green fodder. The fodder crops should be harvested and chaffed at proper stage of growth. The early harvesting of crops affects the production of different acids. Thus the green fodder should have about 30–35% dry matter. In silo pits, the bottom and sides should be carpeted with dry grass or long straw of grasses or cereal crops etc., so as to make 5–6 cm

thick carpet all around. This carpeting helps to prevent the direct contact between fresh-chaffed material and soil. The fodder to be ensiled should be chaffed in the small pieces (1–2 cm) by using the chaff cutter. The silo pits must be filled very quickly (within 3–4 days) and the materials must be compacted in such a way as to remove as much air as possible through constant pressing either by manual labourers or bullocks or using tractor. The exclusion of air causes fermentation under anaerobic condition. The level of chaffed material should be about 1–2 m above the ground level. During the course of fermentation, the material will gradually settle down. Urea at the rate of 3–4 kg per t of chaffed material is mixed with or sprinkled evenly on different layers, if the chaffed material happens to be very low in protein content in the case of cereal fodder. The silo pits after filling and compacting the material carefully, should be given a dome-like shape for drainage of rainwater. Then thick layer of straw is put on the chaffed material from all sides and over the straw a thick layer of moist soil (10–12 cm) is spread. The surface is covered either by mud plaster or polythene or alkathene sheets. This avoids contact of atmospheric 'N' with ensiled material, which prevent the anaerobic fermentation. The silage is ready after 2–3 months. A silo pit is opened and the material is removed daily by exposing little surface area to prevent sunlight. The feeding of the silage should be regulated in such a way that the silage is used within a reasonable period. Otherwise long exposure causes drying and deterioration in keeping quality. Silage may be fed in small quantities (4–5 kg per cow) to start with and later quantity may be increased to 15–20 kg. Under ideal condition, it can be stored easily for 1 year.

E. Advantages

It is more suited in lean seasons when weather is not conducive for haymaking. Thick stemmed crops like sorghum and maize are better utilized. Weeds are used as fodder, consequently the weed seeds are destroyed. The final product is highly palatable and nutritious. Organic acids produced during ensiling are similar to those organic acid produced in the digestive tract of the animals (ruminants) and used in the same manner (Lactic acid 3–13% and Butyric acid 0.2–0.5 %).

TERMINOLOGIES

Agrostology: A science, which deals with the study of grasses, their classification, management and utilization.

Forage crops: Crops, which are primarily grown for livestock feed for making hay or silage or utilized as green fodder or grazed by animals.

Fodder crops: Crops, which are harvested and used for stall-feeding. Mostly these crops are grown for both fodder as well as grain purpose *e.g.*, fodder sorghum, fodder maize, fodder cowpea, horse gram etc.

Silage: It is the product obtained by packing fresh fodder in a suitable container and allowing it to ferment under anaerobic conditions without undergoing much loss of nutrients.

Ensiling: The process of making silage.

Hay: It can be defined as conversion of green forage in to dry form without affecting the quality of original material.

Ley farming: Annual arable crops are rotated with biennial/perennial pastures, which is used for soil moisture conservation and grazing. *E.g.*, sorghum–pasture–castor (I year–II and III year–IVth year).

Quartering: Removal or thinning of excess tillers from the clump is called quartering. It is generally done from 3rd year onwards in grasses like cumber Napier grass.

Soiling: Feeding harvested fodder directly to cattle.

Paddock: Small forced field used for grazing purpose.

Cropping System and Farming System

In the recent past, cropping systems approach has gained importance in agriculture and related enterprises. A system consists of several components, which are closely related and interacting among themselves. In agriculture, management practices are usually formulated for individual crops. However, farmers are cultivating different crops in different seasons based on their adaptability to a particular season, domestic needs and profitability. Therefore, production technology or management practices should be developed keeping in view all the crops grown in a year or more than one year if any sequence or rotation extends beyond one year. Such a package of management practices for all the crops leads to efficient use of costly inputs, presides reduction in production cost. For instance, residual effect of manures and fertilizers applied and nitrogen fixed by legumes can considerably bring down the production cost if all the crops are considered than individual crops. In this context, cropping systems approach is gaining importance.

16.1 CROPPING SYSTEM

It is an important component of a farming system and it represents the cropping pattern used on a farm and their interactions with farm resources other farm enterprises and available technology which determine their make up.

A. Cropping Pattern

Cropping pattern means the proportion of area under various crops at a point of time in a unit area. If cropping pattern indicates the yearly sequence and spatial arrangement of crops and fallow on a given area.

B. Crop Rotation

(a) **Meaning:** Crop rotation refers to recurrent succession of crops on the same piece of land either in a year or over a long period of time. Component crops are so chosen so that soil health is not impaired or Crop rotation refers to growing different crops in succession on a piece of land in a specific period of time with an objective to get maximum profit from least investment without impairing the soil fertility. This may also be defined as the repetitive cultivation of an ordered succession of crops (or crops and fallow) on the same land and one cycle may take one or more years to complete.

(b) **Principles:** There are certain principles, which should be adhered to, to make a rotation successful. These principles are as follows:

- Crops with top roots should be followed by those, which have fibrous root system. This helps in proper and uniform use of nutrients and water from the soil and the roots do not compete with each other.
- Leguminous crops should be grown after non-leguminous crops because legumes fix atmospheric-N into the soil and add more organic matter to the soil. Actually, non-legumes are fertility depleting crops.
- More exhaustive crops should be followed by less exhaustive crops. For example, potato, sugarcane, maize, etc need more inputs than oilseeds and pulses.
- Selection of the crops should be demand based. The crops, which are needed by the people of the area, can be easily sold at a higher price.
- Selection of crop should be problem based. For instance:
 - On sloping lands which are prone to soil erosion, an alternate cropping of erosion-promoting crops *e.g.*, millets and other row crops and erosion resisting crops, *e.g.*, legumes should be adopted.
 - Under dry land farming or partially irrigated areas, the selection of crops should be such, which can tolerate the drought spell. Similarly in low lying and flood prone areas the crops should be such, which can tolerate water stagnation *e.g.*, paddy, jute, etc.
 - Selection of crops should suit the financial condition of the farmers.
 - Crops selected should also suit the soil and climatic conditions.
- Crops of the same family should not be grown in succession because they act like alternate hosts for insects/pests and disease pathogens. Apart from this, different types of weeds are found associated with various crops, therefore, selection of the same type of crops in rotation encourages weed problems in the field.
- An ideal crop rotation is one, which provides maximum employment to the family and farm labourer. Some common crop rotations followed in various parts of the country are given below:

<i>Rotation</i>	<i>Duration</i>
Paddy–Wheat	1 Year
Maize–wheat	1 Year
Maize–potato	1 Year
Soybean–wheat	1 Year
Maize–potato–sugarcane	2 year
Paddy–sugarcane–wheat	2 year

(c) **Advantages:** The major advantages of following proper crop rotation principles are:

- Agricultural operations can be done timely for all the crops because of less competition.
- Soil fertility is maintained by legumes through fixing of atmospheric nitrogen encouraging microbial activity and maintaining physicochemical properties of the soil. The soil is also protected from erosion, salinity and acidity.
- An ideal crop rotation helps in controlling insect pests and diseases. It also controls the weeds in the fields.

- Proper utilization of all the resources and inputs could be made.

Farmers get better price for their produce because of its higher demand in the locality or in the market.

C. Need

In countries like India, the population is increasing by leaps and bounds and by 2010 A.D., it will cross 1.5 billion demanding a food grain supply of 250 m.t. per year from the present level of 145 m.t. from the 132 m.ha of cultivated land. By the end of 2020 A.D., the perceptible land availability will be less than 0.17 ha. And by all possible means like reclaiming the problem soils and wastelands the net area cultivated could be increased to 150 m.ha only. The other estimate shows that the cultivated area may be even reduced because of increasing population and due to industrialization and urbanization to meet food demand of even growing population the total production has to be increased by

- Increasing the area under cultivation.
- Increasing the productivity *i.e.*, yield per unit area/unit time.

Increasing area under cultivation is seldom possible and the alternative is to increase the productivity by intensive cropping, which means the cropping systems.

16.2 EFFICIENT CROPPING ZONES

The present concept of cropping pattern defines it as the proportion of area under various crops at a particular time in a given area. But this concept has got some limitations.

- The unit of classification is political and administrative. The scientific and natural features such as soil and climate did not figure with greater emphasis.
- The cropping pattern was determined by the spread of crop expressed as percentage of the total area of important crops. It is not necessary that spread and cropping efficiency will go together.
- Though the cropping pattern has been evolved after centuries of experience, in national perspective it is not necessarily the most efficient use of land and other resources.
- No cropping pattern can hold good for all times. It has to change with the improvement in technology and economic factors *e.g.*, sugarcane and cotton average shrinks when the prices are more favourable for grain crops and *vice-versa*.

Therefore, a new concept has been evolved which refers to both time and space sequence of crops. It includes the identification of the most efficient crops of the region, which is considered a homogeneous soil and climatic belt, the rotation in which the crop best fits in, and the intensity of cropping. So the cropping pattern has been scientifically defined as yearly sequence and spatial arrangement of crops or crops and fallow in a given area (Palaniappan, 1985). According to the new concept, the most efficient crops will be identified in a homogeneous region and put in the yearly sequence (rotation) where they fit best and the space (area) of those crops, which are inefficient, will be reduced and area of efficient crops will be increased. This way, by knowing the temporal and spatial arrangement of crops in a region, we can identify the cropping pattern followed in the region.

For the purpose of planning the cropping pattern, it is necessary to divide the country into homogeneous regions on some well-defined basis. There can be a number of physical, climatological and agronomic criteria, *e.g.*, climatic index and soil groups, as both are fixed entities and can be better criteria than the political units. It is necessary to know whether crops grown are most suitable for the region; an analysis of productivity and efficiency of various crops in different regions becomes imperative.

This could be done with the help of relative yield index (RYI) and relative spread index (RSI) of the crop.

$$RVI = \frac{\text{Mean yield of the crop in zone}}{\text{Mean all Indian yield}} \times 100$$

$$RSI 100 = \frac{\text{Per cent area of the crop of the total cultivated area in the zone}}{\text{Per cent area of the crop of the total cultivated area in the country}} \times 100$$

These indices are grouped in 7 categories and arranged in Table 16.1.

Table 16.1. Division of Cropped Area on RSI and RYI basis

RSI (%)	RYI (%)						
	200	200-150	150-120	120-90	90-60	60-30	<30
A 200							
B 200-150	Zone-I-High yield and High spread			Zone III-Low yield and High spread			
C 150-120							
D 120-90							
E 90-60							
F 60-30	Zone II-High yield and Low spread			Zone IV-Low yield and Low spread			
G < 30							

It is assumed that the average relative yield is below 90 per cent and a relative spread below 90 per cent can be taken as an index of relatively inefficient areas. The area under every crop can be divided into four zones *i.e.*, Zone-1-High yield and high spread, Zone-2-High yield land low spread Zone-3-Low yield and high spread and Zone-4-Low yield and low spread. The Zone-1 can be considered as the most efficient and Zone-4 as the most inefficient for production. For any important crop most efficient region can be identified and the rotation woven around it will determine the most suitable cropping pattern. The zone, which appears to be inefficient for a crop, should be identified and more efficient crops substituted.

Efficient Crop Zone: It is the zone/area where the productivity of a crop is higher and also stable due to prevalence of optimum condition for crop growth and yield.

1. Rice zone: About 49% of the area is under rainfed and 51% under irrigated. In India, Punjab, Tamil Nadu and Andhra Pradesh are the potential zone for irrigated/low land rice. North-eastern part of the country (Assam, West Bengal, Tripura, Meghalaya, Orissa and Bihar is the potential area for upland/rainfed rice. Semi dry rice is commonly cultivated in Chengelpet and Ramanad districts. In Tamil Nadu, the major rice growing zones are as follows:

- Cauvery delta zone (Tiruchirappalli, Thanjavur, Thiruvarur and Nagapattinam districts)
- North-eastern Zone (Villupuram and Chengelpet district)
- Western Zone (LBP command area-Coimbatore, Erode districts)
- Southern Zone (Vaigai command and Thambirabarani command areas)

2. Wheat zone: Efficient wheat zones are Uttar Pradesh, Punjab, Haryana, Madhya Pradesh and Bihar. Higher production of wheat is from Uttar Pradesh, but Punjab recorded the highest average productivity. Nearly 85% of the wheat is grown under irrigated condition and the remaining 15% under rainfed condition.

3. Sorghum zone: Nearly 94% of sorghum is grown under rainfed condition. In India, potential zone for rainfed sorghum are Maharashtra, Madhya Pradesh, Karnataka, Andhra Pradesh and Tamil Nadu. Irrigated sorghum is raised to lesser extent in southern part of India. In Tamil Nadu, cultivation of sorghum is common in:

- North-western zone (Salem and Dharmapuri districts)
- Western zone (Coimbatore and Erode districts)
- Southern zone (Tirunelveli and Madurai districts).

Sorghum yields are higher in Southern zone. Some area under sorghum in black soils, are diverted for more remunerative crops such as sunflower in Southern zone and maize in Western zone.

4. Maize zone: In India, 85% of area is under rainfed. Efficient zones are Karnataka, Uttar Pradesh, Rajasthan, Bihar and Madhya Pradesh. The average productivity is high in Karnataka. Area under maize is in increasing trend in Western zone of Tamil Nadu (Coimbatore and Erode), North Western zone and Southern zone. In Tamil Nadu, it is mainly grown as irrigated crop during December–January, and July–August months for higher yield. During September–October, it is grown as rainfed crop.

5. Bajra zone: More than 95% of the area is under rainfed condition. It is cultivated in drought prone low rainfall areas and in shallow soils. The potential area is North-western part of India (Rajasthan, Gujarat, Maharashtra and Part of Uttar Pradesh). Rajasthan is the potential area for bajra. In Tamil Nadu, it is largely grown in North-eastern, Western and Southern zones.

6. Finger millet (ragi): It is an important coarse cereal in Karnataka. It is extensively grown in Karnataka, Tamil Nadu, Andhra Pradesh, Orissa, Bihar and in hilly areas of Uttar Pradesh. In Tamil Nadu, it is largely grown as rainfed crop in Dharmapuri District. It is also grown as irrigated crop in Villupuram, Chengelput, Coimbatore and Erode districts.

7. Pulse zone: India is the largest producer and consumer of pulses in the world and accounts 33% of world area and 22% of world production. Nearly 90% of pulses are grown under rainfed condition. In India, potential production of pulses is from Madhya Pradesh, Uttar Pradesh, Maharashtra, Rajasthan and Karnataka. In Tamil Nadu, Cauvery delta zone is the efficient area for the production of rice fallow pulses *viz.*, green gram and black gram. The other areas/zone are North-western zone, Western and Southern zones.

Chickpea: Efficient zones are Madhya Pradesh, Rajasthan and Uttar Pradesh. In Tamil Nadu, it is cultivated in Western zone.

Red gram (pigeon pea): Efficient zones are Karnataka, Maharashtra and Andhra Pradesh. In Tamil Nadu, it is cultivated in Southern zone, Western zone and North-western zone.

Green gram: Efficient areas are Maharashtra, Andhra Pradesh and Uttar Pradesh. In Tamil Nadu, it is cultivated in Cauvery Delta zone, Southern zone and Western zone.

Black gram: Efficient zones are in India are Maharashtra, Andhra Pradesh, Tamil Nadu and Orissa. In Tamil Nadu, it is cultivated in Cauvery Delta zone and Southern zone.

Horse gram: Efficient zones are Karnataka, Tamil Nadu and Maharashtra. In Tamil Nadu, it is cultivated in North-western zone and Western zone.

8. Forage crops: Efficient areas are Punjab, Haryana, Uttar Pradesh, Bihar and Gujarat. In Tamil Nadu, it is largely cultivated in North-western and Southern zones.

16.3 MAJOR CROPPING SYSTEMS

Cropping system vary widely from the simplest system of two crops a year in sequence to complex

intercropping with many crops. Multiple cropped lands can be broadly grouped into lowlands, irrigated uplands, and rainfed uplands.

A. Lowland and Irrigated Uplands

Rice based cropping systems predominate in lowlands. Number of crops per year and the crops that follow or precede rice depends on the period of water availability and the degree of control of water. Where irrigation or rainfall (> 200 mm per month) extends over 9–10 months, the system could be rice-rice-rice, rice-rice-upland crop or upland crop-rice-rice. When this period is limited to 6–8 months, upland crop-rice-upland crop or upland crop may be appropriate. Early maturing rice cultivars are ideal for such sequences. If water is available for 4–5 months, only one rice crop is grown.

B. Irrigated Uplands

In irrigated uplands where winter is mild, upland crops that can follow rice include legumes such as green gram, black gram, soybean and groundnut, cereals such as maize, sorghum, pearl millet, finger millet and other crops such as cotton, sunflower and vegetables. Where the winter is cool, important crops, which can follow rice, are wheat, barley, mustard, chickpea and potato (Fig. 16.1). One irrigable high rainfall uplands, sequential cropping with a wide range of crops is possible. The systems could be cereal-cereal and cereal-legume, oilseeds or other cash crops. In northern India, potato or mustard can be added to maize-wheat by relay plating either of these in the standing maize and delaying wheat by about 2 months. Short duration green gram or fodder crops can be grown after the harvest of wheat in summer.

C. Rainfed Uplands

Cropping systems in rainfed uplands predominantly take the form of intercropping in Alfisols, Inceptisols and Entisols during rainy season. Cereal + pigeon pea system (sorghum + pigeon pea), cereal + cotton (setaria + cotton) are popular in India. In Vertisols of high moisture retentivity, land is kept fallow during rainy season followed by sorghum, chickpea, sunflower or coriander on stored soil moisture during post rainy season (Fig. 16.2). However, double cropping can be practiced if the monsoon is relatively early. Under such conditions, sorghum, pearl millet or a pulse crop can be taken during rainy season followed by sunflower, safflower, chickpea or coriander in post rainy season.

Agronomy of rainfed cropping systems

Agronomy of rainfed cropping systems includes all practices controlled by the farmer that contribute to productivity of crops. Many management decisions are influenced by climate, inherent soil properties and socioeconomic constraints. Each decision on crop and cultivar, land preparation, fertilizers and other agronomic practices will have impact on other factors as well. Intercropping is the major system in rainfed agriculture, although ratooning is practiced under unfavourable rainfall during the season.

Crops and cultivars: Crop combinations depend on climate, local preferences and other site-specific factors. Combination varies with differences in:

- Crop duration,
- Plant morphology,
- Root system,
- Stress tolerance,
- Density response,
- Resistance to pests and pathogens, and
- Yield stability.

Cropping System Region of Importance

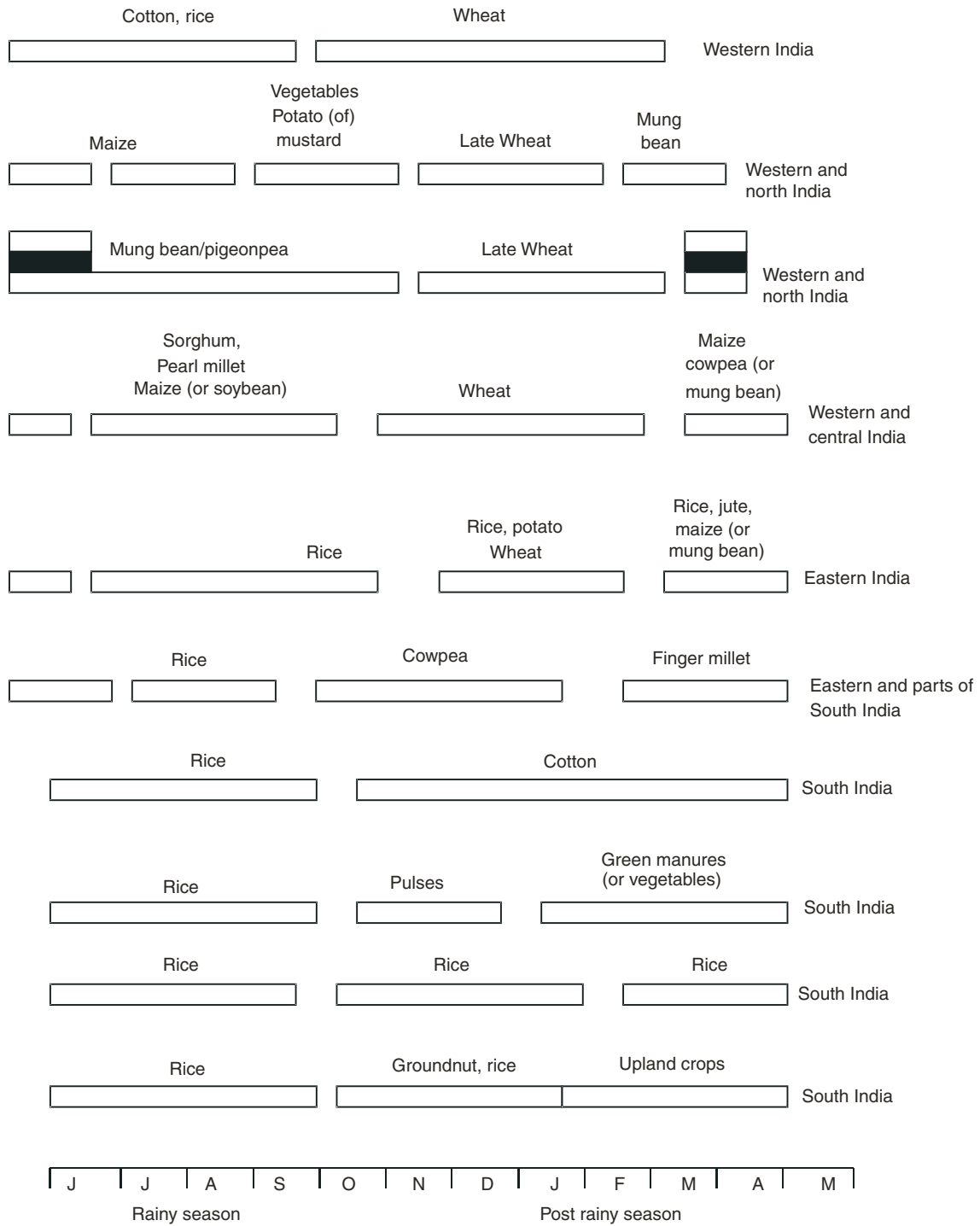

Fig. 16.1 Major cropping systems of irrigated areas in India

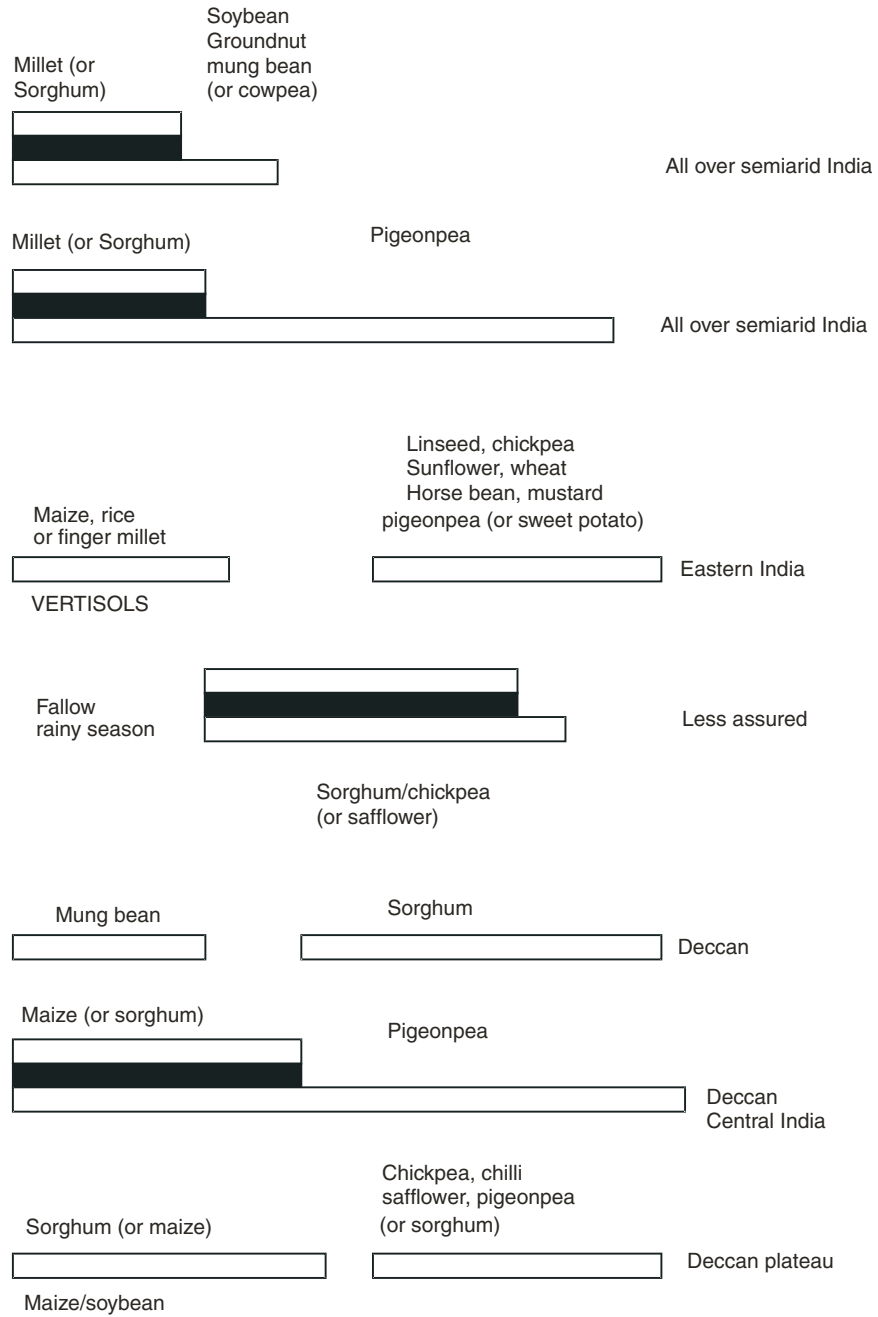

Fig. 16.2 Alfisols, Inceptisols, Entisols region of importance

16.3 TYPES OF CROPPING SYSTEMS

Depending on the resources and technology availability, different types of cropping systems are adopted on farms.

<i>Intercropping</i>	<i>Sequential cropping</i>
<p>Growing of two or more crops simultaneously on the same piece of land in a cropping season. (June–Sept. Kharif) (Oct–Jan. Rabi)</p> <p>Intercropping is intensive cropping mainly in space dimension.</p> <p>Types</p> <p>(i) Inter cropping (ii) Mixed cropping</p>	<p>Growing of two or more crops in sequence on the same piece of land in a farming year (June–May) Includes three seasons.</p> <p>Sequential cropping is intensive cropping mainly in time dimension.</p> <p>Types</p> <p>(i) Mono cropping (ii) Multiple cropping</p>

16.3.1 Intercropping

Intercropping refers to growing of two or more dissimilar crops simultaneously on the same piece of land. The base crop, necessarily in distinct row arrangement and its recommended optimum plant population, is suitably combined with the additional plant density of the associated crop. The objective is the intensification of cropping both in time and space dimensions and to raise productivity per unit area by increasing the pressure of plant population. It has better utilization of growth resources than sole cropping. Generally, legumes and non-legumes are grown. The advantages associated with intercropping are: (i) additional income from the companion crop, (ii) if the principal crop is damaged due to unfavourable conditions like drought, flood, epidemics, etc., companion crop may give sustenance income, (iii) legumes grown as companion crops always benefit the principal crop through N-fixation and also utilizes soil moisture from deeper soil layers, (iv) quick growing companion crops always suppress the harmful weeds thriving in the inter-spaces of the principal crops, (v) gainful utilization of the labourer by increasing more man days employment potential, (vi) better utilization of growth resources—nutrient, water, light and space, (vii) less incidence of insect pests and diseases attack, and (viii) less erosion losses. At the same time, there are several disadvantages of intercropping as (i) the fertilizer management is difficult because the nutrient requirement of the crops is different, (ii) difficulty in harvesting because of different seeding time of crops, and (iii) there are certain combinations which suppress the growth of another crop and may be conducive to insect pests and diseases.

Successful results from intercropping can be obtained provided a suitable companion crop is selected to grow with the main crop. Before putting any intercrop with the main crops like sugarcane, maize, sorghum, bajra, it is very essential to know the prerequisites of the companion crops such as soils and water requirement compatibility: competition for space, sunshine and air, compatibility for pests and diseases; duration and yielding potential and time of sowing and harvesting. On the basis of knowledge of the above some suitable combinations are:

<i>Principal Crop</i>	<i>Intercrop</i>
Sugarcane	Wheat, cowpea, soybean, moong, sunflower
Sorghum	Cowpea, soybean, moong, urd, arhar
Maize	Cowpea, soybean, urd, arhar, castor
Bajra	Cowpea, soybean, urd, arhar, castor
Cotton	Soybean, groundnut
Potato	Wheat, radish

16.3.1.1 Intercropping Vs Mixed Cropping

Intercropping: Growing two or more crops simultaneously on the same piece of land with a definite row arrangement.

For example, growing ground nut and red gram in 6:1 ratio.

Mixed cropping: Growing two or more crops simultaneously on the same piece of land in a proportion without any row arrangement.

E.g., fodder sorghum + fodder cowpea or pillipesera.

I. Sole cropping Vs. Row intercropping

Sole cropping: One crop variety grown alone in pure stand at normal density. It is also called solid planting.

For example, Sorghum at 45×15 cm, groundnut at 30×10 cm.

Row intercropping: Growing two or more crops in the same piece land simultaneously with definite proportion in rows.

E.g., Sorghum + cowpea : at 2:1 or 3:1

Sugarcane + soybean : at 1:2 or 1:1

II. Strip cropping Vs. Strip intercropping

Strip cropping: Growing soil conserving and soil depleting crops in alternate strips running perpendicular to the slope of the land or to the direction of prevailing winds for the purpose of reducing erosion.

Strip intercropping- Growing two or more crops simultaneously in different strips wide enough to permit independent cultivation but narrow enough for the crop to interact agronomically.

III. Row intercropping

Row intercropping is raised by way of additive and replacement series.

(a) **Additive series:** One crop (base crop) is raised in full population and in between the rows of base crop, intercrops are raised at less population level by adjusting or changing crop geometry of the base crop.

(b) **Replacement series:** By sacrificing certain proportion of population of one component crop, another component crop is introduced.

For example, sorghum + cowpea at 2:1 ratio

IV. Relay intercropping

It is interplanting or inter sowing of the succeeding crop in the proceeding annual crops, succeeding crop is sown after the proceeding crop has reached the maturity stage but before the harvest of standing crop or it refers to planting of succeeding crop before the harvest of preceding crop. The planting of succeeding crop may be done before or after flowering, before or after the attainment of reproductive stage, completion of active life cycle, senescence of leaves or attainment of physiological maturity of the crop. The common examples of relay cropping are maize-potato, maize-toria, maize-turnip, ragi-horse gram. The relay cropping is primarily done with the objectives (i) to gain time for multiple cropping, (ii) to plant the subsequent crops at their optimum planting date when the current crop harvest is delayed, (iii) to avoid moisture stress in the post-rainy season, and (iv) to avoid labour peaks at the harvest of the first crop and planting of the second crop. Relay cropping is difficult in the closely spaced and dense canopy cereals as sorghum or millets unless some rows are skipped.

For example, rice–black gram in Cauvery delta regions
 groundnut–cotton in Lower Bhavani Project dry area.
 groundnut (spreading)–horse gram or red sorghum in rainfed lands of
 North-western Zone of Tamil Nadu.

V. Multi tier or Multistoried intercropping

Growing of two or more crops having different growth habit differential rooting pattern and above ground architecture, simultaneously in a piece of land. Perennial crops offer several types of opportunities during their growth. The space between young trees could be utilized for growing crops. Multi-store or multi-level cropping is a system of growing crops of different heights together at the same time on the same piece of land and thus, using land, water and space most efficiently and economically. It is aimed at maximum production per unit area per unit time wherein economic yields of compatible crop species are harvested from different heights. The basement floor is the same for all species and crop yielding floors are increased for more production. Land used efficiency rises beyond 100 per cent. The land use efficiency (LUE) can be expressed as:

$$\text{LUE} = \frac{\text{Number of days land used in a year}}{365} \times 100$$

The important considerations for multistoried cropping are: (i) primary companion crops should be quick growing so that they complete their life cycle before the principal crop attains full growth, (ii) companion crops with twining habit except pepper with coconut should be avoided, (iii) secondary companion crops should always be annual or seasonal, preferably vegetable, fodder, tuber crops, (iv) cultivation of legumes as secondary intercrop enriches soil fertility besides given additional income and (v) companion crops should not host the parasites infecting principal crops. Generally, three crops are taken as principal crop, primary companion and secondary companion, Multistoried cropping will be a common feature of Indian agriculture in 2020 A.D. if we want to feed every mouth. In south India, coconut (10–30 m) + pepper (trailed on coconut trees up to 6–8 m) + cacao (1.5–2.5 m) + pineapple (forms the ground floor, 1.5–2 feet) is a common example, other examples could be–coconut + pepper + grasses, coffee + banana + arhar. The other examples are:

For example,

- Coconut +bajra-napier grass + stylo in Western zone of Tamil Nadu;
- Sorghum + red gram + lab lab + pillipesara : Tamil Nadu;
- Ground nut + castor + red gram + lab lab. : Tamil Nadu;

VI. Alley cropping or Hedgerow intercropping

Raising two or more crops in alleys. For example, fodder crops in path way.

Advantages of the intercropping systems

- Higher productivity per unit area per unit time with stability in production.
- Efficient and better use of growth resources like natural–land, light and water and applied–labourers, manures, fertilizers, crops and varieties.
- Efficient management of weeds, pest and diseases.
- Providing physical support to other crops. For example, Betel vine or black pepper vines on coconut or arecanut. Lablab on sorghum.
- Providing wind shelter and shade to the component crops. For example, Oak for tea or *Albizzia* for Tea or castor or red gram for turmeric.

- Erosion control by providing continuous ground cover. For example, Bajra or sorghum + pillipesara.
- Insurance against complete crop failure due to aberrant weather condition under rainfed situation.
- Mutual benefits of component crops, which is termed as annidation.
- Mobility of essential nutrients to each component crops by the other.
- For example, sorghum + pulses—pulses provide N by fixing atmospheric N.

Disadvantages

- Yield decrease due to adverse competitive effect.
- Creates obstruction for free usage of farm implements and machinery for various cultural operations. For example, cotton + onion/junior hoe.
- Acts as alternate hosts for various pests and diseases by harbouring insect pests and diseases.
- Hindrance to chemical weed management.

16.3.1.2 Multiple Cropping

(a) **Concept:** It refers to intensification of cropping both in time and space dimensions. It includes sequential cropping, inter-cropping and mixed cropping. In simplest form, multiple cropping is a one-year cropping system in which two or more crops are grown within a year; if all the crops are cereals it will resemble monoculture in its advantages and requirements. It may be pointed out that this pivotal theme of intensive cropping may manifest itself in various forms such as relay, inter or just multiple cropping. In a broader sense, it is continuous cropping. If all the post-harvest operations are taken into consideration, then they are overlapping operations.

The philosophy of multiple cropping is the maximum crop production per unit area with minimum soil deterioration; the requirement of multiple cropping underlying the suitability of variety which need not give maximum yield or returns during its specific period. Instead, it must match in a crop sequence to give maximum return from production and use of resources over the full term of one year or other appropriate time span.

(b) **Important considerations for multiple cropping:** There are some important considerations for multiple cropping, such as (i) the crop should be agro climatically suitable and technically feasible, (ii) select most profitable crops capable to utilize growth resources and land in best manner, (iii) the crop combinations and in put rations should be compatible with farmer's skill, enterprise preference, health, age and capital, (iv) assured irrigation facility, (v) local availability of essential inputs like improved seeds, fertilizers, pesticides, (vi) stable marketing and storage facilities, (vii) good transportation facilities, (viii) easy availability of credit, (ix) availability of cheap labour, and (x) proper adjustment of sowing and harvesting time of crops. A due consideration to all these points will make multiple cropping successful and meaningful.

(c) **Types:**

1. Sequential cropping: It refers to growing two or more crops in sequence on the same field in a year. The succeeding crop is planted after the preceding crop has been harvested. Actually, crop intensification is only in the time dimension. There is no intercrop competition. One has to manage only one crop at a time in the same field. Sequential cropping may be of many types as—(i) double cropping—growing of two crops a year in sequence, (ii) triple cropping—growing of three crops a year in sequence, (iii) quadruple cropping—growing of four crops a year in sequence and (iv) ratoon cropping – cultivation of crop regrowth after harvest of plant crop, not necessarily for grain. Sequential cropping systems in irrigated conditions are based on the availability of short duration, photo-insensitive and thermo-insensitivity high yielding varieties while cropping systems of short duration, photo-insensitive and

thermo-insensitivity high yielding varieties while cropping systems under rainfed conditions have been developed depending on availability of cultivars with a short growing period that escape drought.

Ratoon cropping or ratooning refers to raising a crop with regrowth coming out of roots of stalks after the harvest of the crop.

For example, sugarcane–14 ratoons, Sorghum–Two or Three ratoons
Rice–‘Intan’ variety.

Advantages

- Increase the productivity of the system.
- Influence the soil conditions favourably.
- Efficient utilization of available resources like nutrients, water and light.
- Residual influence of previous crops on (legume effect 15–120 kg N/ha) succeeding crops.

Disadvantage

- Carry over effects of pests and disease
- Allelopathic effect *e.g.*, sunflower.
- Immobilization of N. *e.g.*, sorghum.
- Shift in weed population and species.

2. Mono cropping or monoculture: Growing only one crop (same crop) on a piece of land year after year in the same field. Due to certain specific reasons, (*e.g.*), ground nut year after year under rainfed condition of Tamil Nadu, and flue cured tobacco in Gunter region of Andhra Pradesh.

16.3.2 Fallowing

Fallowing means keeping the land vacant without raising any crop is called fallowing.

- Barren fallow–without ploughing and undisturbed land.
- Ploughed fallow–prepare the land and leaving without any crop.

Advantages

- Soil structure is protected.
- Conservation against soil and water erosion.
- Conservation of plant nutrients.
- Building up beneficial soil micro and macro organisms.

Demerits

- Growth of bushy and weedy plants.
- Rodents, pests and disease problem.

16.4 INTEGRATED FARMING SYSTEMS

India with 2.2 per cent of global geographical area supports more than 15 per cent of the total world population, 70 per cent of whom depend on agriculture. It also supports nearly 15 per cent of the total livestock population of the world. One-third of the gross national product comes from agricultural sector. During 2050 A.D., 349 m. tones of food, 25 m. tones of vegetable oil and 92 m.m³ of industrial wood shall be needed for approximately 1667 million people.

As of now, out 328.73 m. ha of geographical area approximately 18 per cent is under forest; only 13.5 per cent is not available for cultivation. Total problem areas constitute 173.65 m. has which include

areas subject to wind and water erosion (145 m. ha), water-logged areas (8.53 m. ha), alkali soils (3.58 m. ha), saline and coastal sandy areas (5.50 m. ha), ravines and gullies (3.97 m. ha), shifting cultivation (4.91 m. ha) and reverie torrents (2.73 m. ha). Besides 40 m. ha are prone to flood and 260 m. ha are drought prone. Thus the net sown area is 136.18 m. ha (41.42 per cent of the total geographical area) (Subbaian *et. al.*, 2000).

Unlike industries, agriculture is practiced by 105 m. farm families who live in 0.6 m. villages. More than 40 per cent of them are below the poverty line. Nearly 85 m. farm families belong to small and marginal categories. In spite of increase in food production, after the independence of the country, only in north-western India, per capita food production has increased and it has declined in other parts of the country. The per capita availability of land during the same period has declined from 0.48–0.15 ha by 2000 A.D. Per capita investment in agricultural infrastructure is the lowest in eastern India, where the density of population is the highest. Only 25–30 per cent of the modern agricultural technologies have reached the farmers. This is often because the technology has not been consistent with conditions of the farm situations.

The benefits of modern technology have, however, been restricted to favourable farming situations. Only 44 out of 453 districts are contributing half of the total food grain basket of the country. This clearly suggests that the technology supposed to be scale and resource neutral has been confined to the districts with favourable farming conditions. Since there is no further scope for horizontal expansion of land for cultivation, the only alternative left is for vertical expansion and diversification of farm enterprises with less demand on space and time particularly for small and marginal farmers (constituting 76 per cent of the farming community) who do not have much of resources, specially in rainfed areas (70 per cent of the total cultivated land). The new farming system research strategy should, therefore, necessarily concentrate on developing technology with participatory approach within the biophysical and socio-economic environments in which the farmers operate.

16.4.1 Present Research Thrust and its Limitations

The existing programme of the ICAR is a component research and there is no system-based programme. The response of a component in isolation does not necessarily fit into a systems perspective. The individual programme ignores the socio-economic and biophysical aspects of the farming community.

The limitations of the conventional model of agricultural research and extension in dealing with interactive matrix are well recognized. The reductionist component research approach curtails system perspective resulting in wide gap in technology development and utilization particularly for the resource-poor farmers. Systems research takes into consideration appropriate perspective in handling a complex undertaking such as farm enterprises, diversification and their interaction on farm productivity. The challenge is to design practical integrated farming systems that can be adapted to regions, minimize energy and base inputs, and are sustainable. Design and implementation of integrated farming systems require collaboration among agricultural, social, economic, and ecological disciplines. They also depend upon the full participation of farmer. It may be probably impossible to develop efficient integrated farming systems without interdisciplinary planning and implementation. A major challenge to agricultural research and development is the need for modifying institutional structures and research and development methodologies to allow such collaboration.

16.4.2 Definition

Farming system is a complex inter-related matrix of soil, plants, animals, implements, power, labour, capital and other inputs controlled in part by farming families and influenced to varying degrees by political, economic, institutional and social forces that operate at many levels. The farming system,

therefore, refers to the farm as an entity of interdependent farming enterprises carried out on the farm. The farm is viewed in a holistic manner. The farmers are subjected to many socio-economic, biophysical, institutional, administrative and technological constraints. Farming system conceptually is a set of elements or components that are interrelated which interact among themselves. At the centre of the interaction is the farmer exercising control and choice regarding the type and results of interaction.

Any farming system, however, is subject to what is potentially possible in technical terms. It is the human environment that provides sufficient condition for development and utilization of a particular system. A farming system obviously is very complex. Therefore, any agricultural technology well suited to a particular agro-ecological situation and socio-economic environment may not be adopted by other farmers. Unless both natural and human environments are considered, agricultural research will not result in relevant agricultural technology. The income from cropping alone in small and marginal farms is hardly sufficient to sustain the farmers' family. With the decline in farm size (0.15 ha) due to explosion of population, it would be increasingly difficult to produce enough food for the family by the end of the century. Therefore, the farmer, to be assured of a regular income for a decent living (above the poverty line), a judicious mix of any one or more of these enterprises with agronomic crops should complement the farm income and help in recycling the farm residue/waste. The selection of enterprises must be based on the cardinal principle of minimizing the competition and maximizing the complementarity between the enterprises (Annadurai *et. al.*, 1994b).

16.4.3 Development

World population has been increasing by leaps and bounds. India's population is expected to reach 1370 and 1660 m. in 2030 and 2050 A.D. respectively. The country's food production has reached an all time high of 204 m.t. during 2000. Food production level of 289 and 349 m.t. will be needed to satisfy the projected population in 2030 and 2050 A.D. respectively. The net cultivable area is 142.8 m ha. Unlike the population spurt and corresponding food need for 2050, there is every chance that the land area under cultivation will decrease due to diversion of some of the cultivable area to buildings and industrial purposes. It is anticipated that the land area available for cultivation in 2050 would be 137 m ha. So, it becomes necessary to increase the productivity almost to double of what we are producing today. This could be made possible by putting the land, both irrigated and rainfed, under intensive cultivation. Fortunately most of our country lies in tropics and so is blessed with abundant solar energy, thus making cropping round the year possible. The only way to increase agricultural production is to increase the productivity per unit area per unit time. The cropping systems, genotypes, geometry of planting and management practices are designed to increase the productivity, simultaneously making efficient use of available resources and stabilising yields (Palaniappan and Annadurai, 1999).

Modern agriculture emphasises two dimension *viz.*, time and space. Time concept relates to increasing crop intensification in a situation where there is no constraint for inputs including irrigation. In other words increasing the cropping intensity in areas where the production potential *viz.*, land is under utilized even with full resource potential. It is a time bound program where, for most of the field crops, it is considered for 365 days or 12 months. In the case of long duration and perennial crops the duration of each rotation will vary from two or three years depending upon the duration of the constituent crops. The areas, where only one crop (100 per cent) two crops (200 per cent) three crops (300 per cent), are raised in an year, leaving the land fallow for two to eight months the cropping intensity has to be increased to 200, 300 and 400 per cent respectively within one year. This will ultimately help to enhance the productivity. In case of rainfed areas where there is no possibility of increasing the intensity of cropping, the other concept *viz.*, 'space concept' can be applied. By raising of crops/other agricultural allied components in a vertical dimension, the land equivalent area can be increased. Thus by making

use of these time and space dimensions either in irrigated or in rainfed areas within specified time span, say a year, and unit area of land, a hectare, productivity is sought to be increased by repeated and/or intensified cropping. This calls for urgent action on the part of Agronomists and Scientists of related disciplines to devote their attention on the design and testing of cropping systems for different regions. Income through arable farming alone is insufficient for bulk of the marginal farmers. Activities such as dairying, poultry, fish culture, sericulture, biogas production, edible mushroom cultivation, agro forestry etc. assume, critical importance in supplementing their farm income. These activities fit well with farm level infrastructure and ensure fuller utilisation of by-products.

Integrated Farming System (IFS) is the answer to increase food production and farm income and for improving nutrition of the small-scale farmers with limited resources without any adverse effect on environment and agro-ecosystem. In a cropping system, the amount of by-products can be as high or higher than marketable produce. This may go to waste if not utilised in an animal enterprise. Hence, integration of different agricultural allied enterprises with crop activity as base will provide a way to recycle low cost produces at farm level/no cost waste materials of farm from one enterprises to another and thus reduce the cost of production of the economic produce and finally to enhance the net income of the farm as whole (Annadurai *et al.*, 1994a).

16.4.4 Characteristics of an Improved Farming System

Sustainable system must (a) maintain the long-term biological and ecological integrity of natural resources, (b) sustain a desirable level of support to a farm's, community's or regions social, political, and economic well being, and (c) enhance quality of life. To be operational, however, sustainability must have tangible and objective criteria (*e.g.*, soil and water conservation, productivity restoration, improvement in water quality in relation to dissolved and suspended loads, a positive thermodynamic energy balance, improvement in air quality, reduction in use of off-farm input for the same level of production and profitability, and acceptable life style as influenced by socio-political factors). All of these criteria are quantifiable but also have a time dimension. Over what period of time are these changes desired or achieved—months, years, decades, or centuries? Is the system that we desire to achieve closed, static, steady state, or dynamic? Obviously, closed or static systems, through ecologically stable, are not productive enough to meet present demands and future needs. Because the system is dynamic, what is the energy flux involved in terms of output/input ratio and what is the carrying capacity of such a system? It is not only the energy efficiency but also the total energy flux that is very important in sustainability. What are the indirect costs of achieving such a goal? Indirect costs are indeed important factors to be considered. For example, reducing the use of off-farm input may necessitate bringing additional land into production. The latter may be marginal, subject to severe problems of accelerated erosion and other degraded processes. Substitution of inorganic fertilizers with organic amendments like green manure may equally endanger the quality of surface and ground water. Will substitution of input by management have serious social and economic implications?

Sustainability must be assessed at different levels or hierarchies (*e.g.*, technology, sub-system, or system). Therefore, the choice of a criterion to assess sustainability would depend on the hierarchy to be evaluated. Agronomic yields and productivity are useful criteria at the level of crop or cropping system. Profit rather than production is the suitable criterion at the level of farm household or farming system. An assured supply of raw materials, off-farm income, and preserving the productive potential of land resources and environmental quality are appropriate criteria for evaluating the sustainability of a community or a region. A system sustainable at a lower level (crop or cropping system) may, however, not be sustainable at a higher level (community or nation).

Furthermore, a system that is economically viable in the short run may not be ecologically viable in the long run. Farm households or communities may adopt systems that are economically viable in the short run but are ecologically detrimental to the community or region in the long run. Typical examples of ecologically incompatible systems include resource-based agriculture with little or no input, intensive use of steep slopes and other marginal lands, uncontrolled grazing at excessive stocking rates etc., the strategic questions to be considered are:

- What system or systems should be made sustainable?
- What policies or incentives are needed to bring about these changes?
- Who is responsible for implementing these policies?

These are difficult but relevant policy questions, because in most cases the beneficiary may be a community or a region rather than the individual household. Furthermore, some of the benefits may not be strictly in economic terms. A critical appraisal of the first question is important. Should the farm household, community, or national policy makers decide which farming systems should be made sustainable (*e.g.*, intensive food crop production, plantation crops, or food crops)? Keeping national interests in perspective, policy makers can provide appropriate incentives to transform subsistence agriculture into intensive systems of food crop production. Once that decision is made, policy makers have several options/tools for using technologies associated with sustainable management of soil and water resources for a chosen system (*e.g.* conservation tillage, mulch farming, agro forestry, water harvesting, fertilizer use, cover crops, and multiple cropping).

16.5 MODELS FOR DIFFERENT AGRO-ECO SYSTEMS

16.5.1 Integrated Farming System for Wet Land

A. IFS

IFS is a resources management strategy to achieve economic and sustained agricultural production through two or more interrelated or interdependent agricultural allied enterprises, to meet diverse requirements of the farm house hold, while preserving the resource base (Soil fertility) and maintaining a high environmental quality.

Advantages of IFS

- Increased income.
- Income at short periodic intervals from different components/enterprises.
- Yield stability.
- Employment generation throughout the year.
- Effective utilization of farm residues and livestock wastes (better organic recycling).
- Optimal utilization of all resources.
- Meeting the energy need of the family to a considerable extend.
- Production of diversified farm products leading to balanced diet.
- Improved standard of living of the farmers.

B. Wet Land Farming

It is otherwise called as low land farming. Here the soils are usually flooded or copiously irrigated to keep the soil in a continuously submerged condition.

Irrigation is through Canals, Ponds or Tanks.

C. Types of IFS

1. Crop based IFS: Here, crop production is the major activity, utilizing a greater share of available resources and often contributing more of total income. Other activities complement the crop production activity by way of recycling of organic waste and supplementing the income. The crop by products can be utilized for the allied enterprises. For example,

Crop + Dairy
Crop + Poultry
Crop + Fish

2. Live stock based IFS: Here, rearing of livestock is the major activity, which contributes the major share of income. Cropping is to plan in such a way to meet the fodder and feed requirement of the livestock. For example,

Poultry Farm
Goat/sheep Farm
Fish + Piggery + Crop.

3. Tree based IFS: Cultivation of multipurpose tree crop to meet the requirements of fuel, feed, fodder, wood and timber. Annual field crops will be raised as intercrop in between tree crops.

4. Horticulture based IFS: Growing of either vegetable crops and fruit trees or both serve as the major component. In between fruit trees, annual field crops can be cultivated.

D. Features of Wetland

Cropping	:	9–12 months in a year.
Source of Water	:	Canals, Ponds, Tanks.
Climate	:	Arid and Semiarid.
Problem	:	Over irrigated/water logging.
Fertilizer application	:	Liberal to maximize the yield.
Other problems	:	Drainage, soil health due to continuous submergence, salt affected soils, mainly surface salinity.

E. Crops in Wetland

rice–rice–rice	with assured irrigation
rice–rice–rice	fallow pulses with limited use of water
fallow–rice–rice	fallow pulses with limited use of water
rice–rice–upland crop (ground nut)	
upland crop–rice–rice	
rice–rice–cotton	

F. IFS for Wetlands

IFS approach introduces a change in the farming techniques for maximum production in the cropping pattern and takes care of optimal utilization of resources in which farm wastes are better recycled for productive purposes. It comprises the cropping system, the livestock system and the farmhouse hold. The final outcome is to get into the useful products that can be consumed or sold. Selection of suitable agricultural enterprises, suited to the given agro-climatic conditions and socio-economic status of the farmers would bring prosperity in the farming.

Components/enterprises proposed for IFS under wetland conditions

- Multiple cropping including sequential cropping and multi-tier cropping, inter and relay cropping.
- Integrating livestock, cow, goat, piggery etc., along with cropping enterprises.
- Combining fish (Aquaculture) cum poultry in the existing system.
- Agro-forestry on tree components in the existing system.
- Inclusion of mulberry cultivation and sericulture or lac culture with crops.
- Mushroom cultivation with cropping.
- Inclusion of apiary and horticultural crops etc.

I. IFS Models for Coastal Ecosystem, Tamil Nadu, India

i. Crop : rice

Early duration	–	Rohini, Cauvery, SSRC 91216 culture
Medium duration	–	IR 20, TRY-1
Long duration	–	Pankaj, Jaganath
Flood resistant	–	IR43, ADT40, TRY-1.

ii. Livestock system

Cows, Poultry, Goat, Fish, Prawn and Duck.

Prawn : Water canals in homestead or coconut groves connected directly or indirectly with backwater having water having free tidal water movements can be converted into productive prawn farms. From an area of 400 m² of water canal, 12–16 kg of prawn (Indian white variety) can be produced in 90 days. It can fetch Rs. 50–60 per kg. The main expenditure will be only Rs. 2000/- for providing sluice gates to regulate the flow of water. Prawn culture can be integrated with duckery, poultry, agricultural, horticulture or piggery.

Fishes : In fresh water areas, fishes of Indian major carps viz., roghu, catla and mirgal are grown in perimeter trenches in rice plots.

Tree Crops: Major tree crops suitable for coastal region are coconut, cashew nut and jackfruit. The forest tree species are *Casuarina sp.*, *Acacia sp.*, *Eucalyptus terticornis*, *Pongamia pinnata*, *Azadirachta indica* and *Anacardium sp.*

Farm Pond : The farm pond technology which involves digging of a pond in 20% of the area in coastal lowland area and spreading the excavated earth in remaining 80% of the field is gaining popularity among the farmers in coastal region. In the field so developed, the farmers are able to get a samba crop of high yield rice variety in monsoon season and vegetable in winter and summer months.

II. IFS Model for single crop wetland area (Periyar-Vaigai-command area), Tamil Nadu, India

Cropping		Crop + vegetables + poultry + fish (in ha)
Rice	–	Maize 0.20
Rice	–	Green gram 0.20
Rice	–	Groundnut 0.20
Rice	–	Green manure 0.20

Vegetables

Bhendi	–	Tomato–Brinjal	0.05
Bitter gourd	–	Moringa–chillies	

Poultry unit

Layer	–	20 Nos.
-------	---	---------

Fishery unit

Mushroom cultivation if condition prevails.



Fig. 16.3 Rice cropping-Fishery-Poultry model

III. IFS model for a double crop wetland, Coimbatore, Tamil Nadu, India

Components : Cropping–rice
 Fish
 Poultry
 Mush room

Area Allocation

(a) Cropping	(in ha)
Rice–Rice–Maize	0.16
Rice–Rice–Ground nut	0.10
Rice–Rice–Sesamum	0.10
Fish pond	0.04
Total area	0.40

- (b) **Fishery**
(400 fingerlings) 0.04
- (c) **Poultry unit**
(over fish pond) 20 layers
(droppings as fish feed)
- (d) **Mushroom** Production capacity of 2.0 kg/day/unit



Fig. 16.4 Duck rearing in wetland ecosystem

16.5.2 Integrated Farming System for Irrigated Upland

It is a type of farming where the crops are grown with supplemental irrigation by using water from underground sources. This can also be called irrigated dry land.

A. Features

- Farming will be for around 9-12 months.
- The sources of water are wells and deep bore wells in addition to rainfall.
- The climate is arid to humid.
- Water management is the main criteria, *i.e.*, economic use of water.
- Fertilizer use—liberal to maximize the yield.

B. Constraints

- Salt affected soils are more
- Energy for lift irrigation is a must, but availability is a problem

C. Crops

Crops that can tolerate mild winter

- Legumes – green gram, black gram, soybean, and groundnut.
- Cereals – maize, sorghum, pearl millet and ragi.
- Other crops – cotton, sunflower and vegetables.

Crops that can tolerate cool winter are wheat, barely, mustard and potato.

I. Integrated farming system model for irrigated upland system at Coimbatore, TamilNadu, India**(Crop + Dairy + Biogas + Mushroom)**

Crop Management	Area (ha)
1. Cotton + green gram – Maize	0.56
2. Soybean – Maize-Cotton	0.19
3. Cumbu Napier grass	0.15
4. Lucerne	0.05
5. <i>Leucanea leucocephala</i>	150 trees (border trees)
6. Farm shed	
Dairy Component	– 3 Jersey cows + 2 calves
Biogas	– For effective recycling of farm and animal waste, a biogas unit of 2 m ³ capacity
Spawn and mushroom production	– 1.5–2.0 kg/days

16.5.3 Integrated Farming System for Dry Land

Crop production depends entirely on the quantity of rainfall received or with conserved moisture. Hence, there is every likelihood of crop being facing with mild to severe stress during its growth period. The major constraint is the wind and water erosion. More details are given in the chapter 13—Dry land agriculture.

Crops

Cereal	+	Pigeon Pea
Cereal	+	Cotton
Single crop area	-	Sorghum, Chickpea, Sunflower, Coriander
Double crop area	-	Sorghum/Pearl millet/Pulse during rainy period. Sunflower/Safflower/Chickpea during post rainy period.

I. IFS model for dry lands of Coimbatore (low rainfall < 700 mm), Tamil Nadu, India

	Area (ha)
1. Sorghum + Cowpea (grain)	- 0.2
2. Sorghum + Cowpea (fodder)	- 0.2
3. <i>Leucanea</i> + <i>Cencherus ciliaris</i>	- 0.2
4. <i>Acacia senegal</i> + <i>Cenchrus ciliaris</i>	- 0.2
5. <i>Prosopis Cineraria</i> + <i>Cenchrus ciliaris</i>	- 0.2
Tellicherry goats (20 does + 1 buck)	

II. IFS model for vertisol area of assured rainfall (Aruppukottai), Tamil Nadu, India**Crops**

- | | |
|------------|--------|
| 1. Cotton | 1.6 ha |
| 2. Sorghum | 1.6 ha |

Tree crops

- | | |
|---|-------------------|
| 3. Amla | 1.6 ha |
| 4. Ber | 1.6 ha |
| 5. <i>Cenchrus ciliaris</i>
Tellicherry goat | 1.6 ha
(5 + 1) |

III. IFS model for deep vertisol area of unassured rainfall region (Kovilpatti), Tamil Nadu, India

- | | |
|-----------------------------|----------|
| 1. Cotton | 0.5 ha |
| 2. Sunflower | 0.5 ha |
| 3. Sorghum grain | 0.5 ha |
| 4. <i>Cenchrus ciliaris</i> | 0.5 ha |
| 5. Sorghum (fodder) | 0.5 ha |
| 6. Bajra (fodder) | 0.5 ha |
| 7. Jersey cow | 2 number |

Sustainable Agriculture

Agriculture has been the basic source of subsistence for man over thousands of years. It provides a livelihood to half of the world's population even today. According to the Food and Agricultural Organisation (FAO), people in the developing world where the population increase is very rapid, may face hunger if the global food production does not rise by 50–60 per cent. The contribution of developing countries to world agricultural production in 1975 was about 38 per cent, while that of developed countries, which account for 33 per cent of world's population, was 62 per cent. Only those countries, which can match the demands of the increasing population with increased production, can escape mass hunger. In the pre-independence period, Indian agriculture was usually described as a gamble with monsoons. There used to be a great deal of uncertainty about crop prospects, as monsoons played a decisive role in determining agricultural output and their failures resulted in widespread famine and misery. In the last few years, Indian agriculture has made impressive progress and so is more resilient to the vagaries of the monsoon, although the country's population increased from 361 million in 1951 to more than one billion in 2005.

During this period, the size of farm holdings and the per capita availability of agricultural land have also been decreasing and they are expected to be around 1.4 and 0.14 hectares respectively, by the turn of this century (Table 17.1). With competing demands on land for other sectors of development, this decline is likely to aggravate further.

Table 17.1. Statistics on Population, Food Production and Land Resources

<i>Particulars</i> (1)	<i>1981</i> (2)	<i>2000 A.D.</i> (3)	<i>2050 A.D.*</i> (4)
1. World population (Billion)	5	6.1	9
2. India's population (Billion)—Total	0.7	1.0	1.4
(a) Rural	0.627 (1991)	0.750	0.500
(b) Urban	0.217 (1991)	0.250	0.900
3. Per capita availability of land (in ha)	0.94 (1950)	0.15 ha	...

(Contd.)

<i>Particulars</i> (1)	<i>1981</i> (2)	<i>2000 A.D.</i> (3)	<i>2050 A.D.*</i> (4)
4. Food production (million tons)	175 (1950)	206	550
5. Per capita availability of food grains (g/day)	395 (1950)	573 (1991)	589 (2000)
6. Degraded lands (million ha)	145 (1968)	175 (1990)	Due to deforestation alone 1.3 m.ha. of forest area lost every year

* Projections.

World population today is about more than 6 billion. It is projected to become over 8 billion by 2025 and nearly 10.5 billion by the end of next century. In simple terms, the basic food production must double to maintain the status quo. The hunger must be banished from the surface of earth, as a first responsibility of any civilised society to provide sufficient food for the people who are below the poverty line.

17.1 INDIAN AGRICULTURE BEFORE THE GREEN REVOLUTION

Our traditional farming systems were characterised mainly by small and marginal farmers producing food and basic animal products for their families and local village communities. Farming was highly decentralised with individual farmers deciding on the types of crops to grow depending on climate and soil conditions. These traditions consisted of methods for controlling pests and diseases, and for building soil fertility and structure in their own ingenious ways, since farming did not include the use of chemical pesticides or fertilizers. Rather, soil health and pest control were achieved using practises such as shifting cultivation, conservation, the use of animal manures and farm wastes and the introduction of legumes into crop rotations. By growing a mixture of crops in the fields, early farmers insulated themselves from total crop failure caused by weather or pest epidemics. Even, Alexander Walker, resident at Baroda in Gujarat, wrote in 1820 that green fodder was being grown throughout the year; intercropping, crop rotation, fallowing, composting and manuring were practised; all these allowed continued farming on the same land for more than 2000 years without drop in yields. Further, the crops were relatively free from pests. One of the reasons for the decline in their sustainable system of agriculture was the land revenue collected by the British. A tax of 50 per cent and sometimes as much as 63 per cent revenue was collected and hence more than a third of the irrigated land went out of production. Similarly, an environmentally stable form of tree and forest conservation, which had been developed over the ages, crumbled. Even sacred groves, which were preserved since time immemorial, were turned into coffee, tea, teak wood and sugarcane plantations. Hence, from 1865 through 1900 India experienced the most severe series of protracted famines in its entire history.

17.2 THE GREEN REVOLUTION

After the green revolution was launched in India, substantial increase in the production of food grains was achieved through the use of improved crop varieties and higher levels of inputs of fertilizers and plant protection chemicals. But it has now been realised that the increase in production was achieved

at the cost of soil health and that sustainable production at higher levels is possible only by the proper use of factors, which will help to maintain the fertility of the soil. In fact, about 60 per cent of our agricultural land currently under cultivation suffers from indiscriminate use of irrigation water and chemical fertilizers. The gravity of environmental degradation resulting from faulty agricultural practices has caused alarm among the concerned farmers, scientists and conservationists and greater viable and sustainable farming systems have become a necessity. There has been a series of scientists and policy conference on this issue. One such alternative agriculture system which will help to overcome the problems of soil degradation and declining soil fertility is organic farming and ecological agriculture.

Most of the growth in the food production during the green revolution period is attributed to the higher fertilizer use. The growth of the fertilizer industry in India between 1965 and 1983 has been remarkable. The per hectare consumption of NPK increases from 0.6 kg in 1950 – 50 kg by 1987–88. However, the available data show that the fertilizer consumption is largely confined to irrigated areas which constitute only about 30 per cent of the gross cropped area. The annual fertilizer consumption is expected to rise to about 20 million tonnes by the turn of this century. This rise in fertilizer use is anticipated because:

- N deficiency will continue to be universal in Indian soils.
- Deficiency of P will be next in the order.
- K will become limiting in high productive regions.
- In at least half of the Indian soils, crops would benefit from Zn treatment.
- S deficiency will limit the productivity in a vast majority of Indian soils.

17.2.1 Impact of Green Revolution on the Environment

To increase the agricultural production in the country and to meet the requirements of the expanding population, it became imperative to change the methodologies of crop production. These involved the use of high-yielding varieties and higher fertilizer dosages; increasing the irrigated area and intensive cropping; bringing large areas under one crop; growing crops in non-conventional areas; and changing the crop sequences. The green revolution followed the development of commercial agriculture in the developed countries after World War II, Chemical companies that developed highly toxic and life damaging chemicals for the purpose of warfare, decided to turn their attention on the chemical control of insects, pests and unwanted plants in the farmer's fields. In addition, the production of petroleum-based fertilizers by oil companies was used to replace composts and manures. The food grain production increased dramatically as the policies of green revolution began to take effect. By the year 2000, India will need to produce 230 million tons of food grains on 140 million hectares of agricultural land in order to feed an estimated 1 billion Indians.

This achievement, though remarkable, has also costed us dearly. Along with the increase of food grain production pesticide consumption in India also increased considerably. In 1932 nearly 200 metric tons of chemical pesticides were used, but by 1975 it was 25,000 metric tons, an astounding 375 fold increase over 30 years. Despite increasing use of pesticides, annual crop losses due to pests still amount to more than 15,000 crores. Consumption of chemical fertilizers has gone up seven times in the last 20 years, but production has only increased a miserable two-fold. While we now have enough food ourselves and are concentrating on broadening our food exports, we have apparently sadly overlooked on equitable food distribution to our hungry millions. It is quite unfair to balance our country's trade deficit, caused by expanding imports of petroleum-based products with food exports at the expense of making the same available for local consumption. The modern agriculture techniques such as use of

synthetic fertilisers and pesticides are continuing to destroy stable traditional ecosystems and the use of high yielding varieties of crop has resulted in the elimination of thousands of traditional varieties, with the concurrent loss of genetic resources. In the past, our fore-fathers were consuming chemical-free foods, but now a large quantity of chemical residues getting into the food chain and toxic residues in agricultural commodities is an issue of major concern to everybody.

Our major concern is to meet the internal demands of farm production without degrading the productive environment. Sustainability issues have become highly relevant even under the low input use situations. There is hardly any scope of finding new land area suitable for cultivation. Since the ability of the land to produce food is limited and the limits of production are set by soil and climatic conditions, there are critical levels of population that can be supported in perpetuity from any given land area. Any attempt to produce food in excess for the restrictions set by soil and climatic conditions will, in the long term, result in failure. Degradation of land, hunger and eventual reduction in population are the outcome of such practises. However, the application of technological innovations in the form of new seeds, fertilizers, irrigation and suitable management strategies has bailed such catastrophic predictions in the past. This underscores the tremendous potential of science and shows the possibility of meeting the demands put on our farm production systems without reducing its sustainability, through scientific research.

The progress in Indian agriculture during the last 40 years can be broadly classified under three areas: First, progress in developing the research and educational infrastructure, essential for generating and testing technologies suitable for different agro-ecological regions, secondly, a reasonably efficient input production and delivery system for the production and distribution of seeds, fertilisers and other inputs. Thirdly, evolving policies essential for stimulating higher production by small farmers and increased consumption by the rural and urban poor. Thanks to these steps, growth of food production has on the whole remained above the rate of population growth. Statistics on agricultural production in India from 1960–1988 show that during the period (a) the gross cropped area increased marginally; (b) the area under irrigation nearly doubled; (c) the high yielding variety programme, initiated at the national level in 1966, increased to cover nearly 39 per cent of the cropped area; (d) the total food production increased from 74 million tonnes to nearly 174 millions tonnes; and (e) both the fertiliser and pesticide consumption increased more than 25 times. The ratio of pesticide to fertilizer remained nearly constant at 1:100. Interestingly, the use of pesticides in the public health sector, which has higher than in the agricultural sector until 1966, became almost equal in 1970 and declined significantly thereafter. The number of pesticides used in agricultural sector has always been a more diversified than in public health sector which used only DDT, HCH and malathion.

The introduction of high-yielding varieties changed the agricultural environment leading to numerous pest problems of economic importance. Many of these were either unknown or were minor importance in the early 1960's. Increased irrigation, higher usage of fertilizers and wide adoption of high-yielding varieties led to the resurgence of pests. The high-yielding varieties and the monoculture practices led to material changes in the pest complex. Pests and diseases such as gall midge, brown plant hopper, bacterial blight and tungro virus of rice, which were of minor importance before the green revolution, suddenly assumed major proportions; for instance, *Spodoptera litura* on cotton, maize and tobacco; *Pyrausta* on wheat, maize and sorghum; apple scab and codling moth on apple and Karnal bunt on wheat increased the crop losses due to pests enormously. An important aspect of the resurgence of newer pests in the time-lag between the introduction on of a new variety/agronomic practice and the actual manifestation of the pest epidemic. This varies with pest and the crop. For example, in the rice bacterial wilt there was a practically no time-lag in the very first season of the introduction of Taichung Native-

In Andhra Pradesh in 1963, the disease broke out. In the case of the rice tungro virus, it took four to five years before the disease manifested itself in a virulent form. It took, however, a decade for the brown plant hopper to become a major pest. Similarly, every variety of hybrid bajra, when released, was thought to be tolerant/resistant to downy mildew, but within a few years all proved to be susceptible. Since the high-yielding varieties were more prone to pests and diseases, use of pesticides increased and this brought about (a) widespread occurrence of pesticide residues in nearly every agricultural commodity; (b) increased pesticide resistance in vectors; (c) resistance to pesticides in stored grain pests which was first reported in 1971 and by 1979 six major pests of stored grain became resistant to a number of insecticides and fumigants; and (d) pesticide resistance in pests of agricultural importance becoming an important constraint in increasing productivity. This is true especially for the polyphagous pests such as *Spodoptera litura* (tobacco caterpillar); *Plutella xylostella* (diamond back moth) and *Heliothis armigera* (American boll worm). It is suspected that the *Aphis craccivora* (black aphid), a serious pest of pulses, and *Lipahis erysimi* (Mustard aphid) have also developed resistance to pesticides.

The ills of green revolution are stated to be:

- reduction in natural fertility of the soil
- destruction of soil structure, aeration and water holding capacity
- susceptibility to soil erosion by water and wind
- diminishing returns on inputs (the ratio of energy input to output halves every 10 years)
- indiscriminate killing of useful insects, micro organisms and predators that naturally check excess crop damage by insect pests
- breeding more virulent and resistant species of insects
- reducing genetic diversity of plant species
- pollution with toxic chemicals from the agrochemicals and their production units
- endangering the health of the farmers using chemicals and the workers who produce them
- poisoning the food with highly toxic pesticide residues
- cash crops displacing nutritious food crops
- chemicals changing the natural taste of food
- high inputs increasing the agricultural expenses
- Increasing the farmer's work burden and tension
- depleting the fossil fuel resources
- increasing the irrigation needs of the land
- big irrigation projects often resulting in soil salinity and poor drainage
- depleting the ground water reserves
- lowering the drought tolerance of crops
- appearance of 'difficult' and problematic weeds
- heightening the socio-economic disparities and land holding concentration
- high input subsidies leading to inflationary spirals
- increasing the political and bureaucratic corruption
- destroying the local culture (commercialisation and consumerization displacing self-reliance)
- throwing financial institutions into disarray (as impoverished farmers demand write-off of loans)
- agricultural and economic problems sparking off social and political turmoil resulting in violence.

17.3 SUSTAINABLE AGRICULTURE

Earlier, the subsistence level of farmers forced to over exploit natural resources by way of mining soil

nutrients, cultivating in steep slopes, overgrazing rangelands and excessive collection of fuel wood in order to survive. Now modern crop production technology has considerably raised the yield but has created problem of land degradation, chemical residues in farm produce and atmosphere and water pollution. Hence modern agriculture was not sustainable.

Sustainable agriculture is the successful management of resources for agriculture to satisfy changing human needs while maintaining or enhancing the quality of environment and conserving natural resources. **Sustainable agriculture** is also known as ecofarming (as ecological balance is important) or organic farming (as organic matter is the main source of nutrient management) or sometimes as natural farming or permaculture. Some other designated it as regenerative agriculture or alternative farming. Sustainable agriculture is a food and fiber production and distribution system that:

- Supports profitable production;
- Protects environmental quality;
- Uses natural resources efficiently;
- Provides consumers with affordable, high-quality products;
- Decreases dependency on nonrenewable resources;
- Enhances the quality of life for farmers and rural communities, and
- Will last for generations to come.

17.3.1 Role

Small landholders in the tropics are mainly fed up with rain fed farming and it is being carried out with high risk. In a constant struggle to survive, farm communities have developed numerous ways of obtaining food and fiber from plants and animals (TAC/CGAIR, 1988). A wide range of different farming systems have been developed, each adapted to the local ecological conditions (Okigbo, 1978) Richards, 1988; Dupre, 1990). A closer look at these traditional farming systems reveals that they are not static; they have changed over the generations—and particularly quickly over the last few decades—primarily as a result of the research and development activities of the local people. (Wieskel, 1989; Owasu, 1990). However, rapid changes in economic, technological and demographic conditions demand adjustments in smallholder farming systems. New market opportunities, promotion of chemical inputs and financial constraints may lead farmers to seek short term profits and pay less attention to keeping their agriculture in balance with the ecological conditions. In recent years, the negative environmental and soil impacts of High External Input Agriculture (HEIA) have become increasingly obvious (Wali, 1992; NRC, 1993). At the same time, many disadvantaged communities of smallholders are being forced to exploit the resources available to them so intensively that, environmental degradation is setting in. Hence, it is important to seek new approaches to agricultural development, which will benefit small farmers, halt degradation of natural resources and restore degraded soils and ecosystems.

In 1987, the World Commission on Environment and Development (WCED, 1987) called attention to the immense problems and challenges facing world agriculture for meeting present and future food needs, and to the need for a new approach to agricultural development. The agricultural systems that have been developed over the past few decades have contributed greatly to the alleviation of hunger and the raising of standard of living of poor people (Dora, 1983; Wilken, 1987) who have served their purposes up to a point. But they were developed for the purposes of a smaller, more fragmented world. However, new realities reveal their inherent contradictions, realities while require agricultural systems that focus as much attention on people as they do on technology, as much on resources as on production, as much on the long term as on the short term. Only such systems can meet the challenges of the future (WCED, 1987).

17.3.2 Concepts and Basic Principles

A. Concept

The use of modern farming practices has greatly enhanced the productivity of crops. However, the hazards of the use of agricultural chemicals in causing eco-degradation have prompted many to think rationally and evolve alternatives. The negative impact of pesticides on the environment has been well documented. Pesticides are not specific to the target organisms and kill many useful organisms, thus upsetting the food web in nature. Further, some resistant pests survive even after pesticide application; therefore, higher doses are required to kill them. The pesticide residues in the food chain have endangered the life sustaining systems. Finally, lack of safety measures in the use of pesticides pose adverse health effects on people. The synthetic fertilizers have also jeopardized the environment through nitrate poisoning and exterminating the beneficial soil microflora and microfauna by adversely altering the chemical and physical properties of the soil. Though the agricultural extension personnel are aware of the ill effects of modern technology, they are helpless without an effective alternative system. Therefore, the need for sustainable and ecological agriculture is increasingly felt in the world.

Sustainable agriculture is also referred by other names such as alternative agriculture, ecological agriculture and natural organic farming. It is that form of farming which maintains or enhances the flow of its products without damaging its own long term potential. The United States National Research Council (1989) defined alternative agriculture as “those alternative systems incorporating natural processes reducing the use of inputs of off-farm sources, ensuring the long term sustainability of current production levels and conserving soil, water, energy and biological resource: Organic farming is an agricultural production system, which avoids or largely excludes the use of systematically compounded fertilizers and pesticides. To the maximum extent feasible, organic farming systems rely upon crop rotations, crop residues, animal manures, legumes, green manures to maintain soil productivity and tillage to supply plant nutrients. It looks forward to alternative methods of pest-control like pest resistant cultivars, bio-control agents and cultural methods of pest-control. Such ecological farming systems are highly productive and they should not be mistaken for a reversion to inefficient and less productive farming methods. The adoption of ecological farming is not as simple as one may presume. It is highly knowledge intensive, labour-oriented and a complex system integrating several organic recycling processes.

B. Basic principles

Principle: The use of limited quantities of fertilizers and discrete application of small quantities of target specific pesticides at critical stages of crop damage thereby overcoming the effects of modern agriculture.

The following seven principles will have to be kept in view to achieve success in promoting ecological agriculture:

- Based on both biological potential and biological diversity, land can be classified into conservation, restoration and sustainable intensification areas. Conservation areas are rich in biological diversity and must be protected in their pristine purity. Soils with diminished biological potential are also referred as waste or degraded lands and it should be improved through the adoption of principles of restoration ecology. The diversion of land suitable for sustainable farming should be prevented by legislation. Such lands should be subjected to a continuous soil health monitoring.
- Effectiveness in water saving, equity in water sharing and efficiency in water delivery and use are important for sustainable management of available surface and groundwater resources. There

should be an integrated policy for conjunctive and appropriate use of river, rain, ground, sea and sewage water.

- An integrated system of energy management involving the use of renewable and non-renewable resources of energy in an appropriate manner is essential for achieving desired yield levels.
- Soils in India are often not only thirsty but also hungry. There is a need for reduction in the use of market purchased inputs and not of inputs *per se*. It is in this context integrated systems of nutrient supply assume importance. The components of the integrated nutrient supply system suitable for easy adoption include crop rotation, green manures and biofertilizers. Biodynamic systems that make significant use of compost and humus will help improve soil structure and fertility.
- Genetic diversity and location specific varieties are essential for achieving sustainable advances in productivity. Genetic homogeneity characteristic of modern agricultural systems only leads to greater genetic vulnerability to biotic and abiotic stresses. Diversity of crops and crop varieties will help enhance the yield stability.
- The control of weeds, insect pests and pathogens is one of the most challenging jobs in agriculture. Therefore, an integrated pest management system needs adoption. The conservation and wise use of genetic diversity is essential for breeding strains possessing multiple resistances to biotic and abiotic stresses. Similarly, the conservation of natural enemies of pests is important for minimizing the use of chemical pesticides and for avoiding the multiplication of insecticide resistant pests. Botanical pesticides such as those derived from neem, need popularization. Selective microbial pesticides offer particular promise, of which, strains of *Bacillus thuringiensis* (Bt) serve as an example. Transgenic techniques have made the transfer and expression of Bt toxin possible in several crops.
- Whole plant utilization methods and preparation of value added products from the available agricultural biomass are important both for enhancing income and for ensuring good nutritional and consumer acceptance properties. Both producers and consumers will not derive benefit from production advances if there is a mismatch between production and post-harvest technologies.

C. Feasibility

The shift from chemical to ecological agriculture should be gradual. A sudden switch over could spell disaster and discourage farmers from taking to this course. At least seven to eight years will be needed for the transition and during the interim years the farmers could build up a sufficient organic base to fertilize the fields and improve the fertility of soil. From a purely ecological point of view, ecological farms should have more diversity of species of plants, which invite different species of birds and beneficial insects. As ecological equilibrium is established, the build up of specific pests and pathogens is significantly reduced.

The biggest problem faced by most ecological farmers is that they do not know how to start switching the transition phase, which poses a great challenge, and they do not have any information on how to shift. There is no organized extension machinery to disseminate the proven technologies and in many cases the basis information itself is not available. When the farmers proceed to change the soil fertility using organic manures, they often ignore other aspects of the farming system. For instance, they forget the plant protection aspect. There are no immediate alternatives available to chemical control in the market. One has to develop effective alternatives. So far they are only left with the adoption of preventive methods. Simple changes in transition lead to complications in pest and disease management. Plant derived products are there but they are not as effective as synthetically compounded ones and therefore cannot be an efficient substitute. Farmers should get trained in pest monitoring. While

calculating nutrient balances, ecological farmers should show least dependency on purchased inputs and in addition they must use these little inputs quite efficiently. There have been several positive steps towards this direction. Integrated pest management and nutrient recycling systems have been advocated widely. The heavy reliance on synthetic agro-inputs is gradually removed by substituting farm-grown inputs both for ecological and economic reasons. With more agricultural research institutes, and progressive farmers focusing greater attention on the sustainable agricultural practices, it is opined that more useful practical methods will emerge to profit small and marginal farmers.

D. Goals

Sustainable agricultural systems must maintain or enhance biological and economic productivity of crops, (ii) enhance the efficiency of use of input, (iii) lesser adverse environmental impacts both on and off the farm, (iv) minimize adverse environmental impacts on adjacent and down stream environments, (v) minimize the magnitude and rate of soil degradation and to enhance soil quality and resilience so that the crop productivity can be sustained with minimum adverse impact on soils and environment, and (vi) enhance compatibility with social and political conditions.

The word 'sustainability' is now widely used in development circles. But what does it really mean? According to a dictionary definition, 'sustainability' refers to 'keeping an effort going continuously, the ability to last out and keep from falling'. In the context of agriculture, 'sustainability' basically refers to the capacity to remain productive while maintaining the resource base. For example, the Technical Advisory Committee of the Consultative Group on International Agricultural Research (TAC/CGIAR 1988) states: "sustainable agriculture is the successful management of resources for agriculture to satisfy changing human needs while maintaining or enhancing the quality of the environment and conserving natural resources".

However, many people use a wider definition, judging agriculture to be sustainable if it is (after Gips 1986);

- **Ecologically sound**, which means that the quality of natural resources is maintained and the vitality of the entire agro-ecosystem from humans, crop and animals to soil organisms—is enhanced. This is best ensured when the soil is managed and the health of crops, animals and people is maintained through biological processes (self-regulation). Local resources are used in a way that minimizes losses of nutrients, biomass and energy, and avoids pollution. Emphasis is on the use of renewable resources.
- **Economically viable**, which means that farmers can produce enough for self-sufficiency and/or income, and gain sufficient returns to warrant the labour and costs involved. Economic viability is measured not only in terms of direct farm produce (yield) but also in terms of functions such as conserving resources and minimizes risks.
- **Socially just**, which means that resources and power are distributed in such a way that the basic needs of all members of society are met and their rights to land use, adequate capital, technical assistance and market opportunities are assured. All people have the opportunity to participate in decision-making, in the field and in the society. Social unrest can threaten the entire social system, including agriculture.
- **Humane**, which means that all forms of life (plant, animal, human) are respected. The fundamental dignity of all human being is recognized, and institutions incorporate such basic human values as trust, honesty, self-respect, cooperation and compassion. The cultural and spiritual integrity of the society is preserved and nurtured.

- **Adaptable**, which means that rural communities are capable of adjusting to the constantly changing conditions for farming, population growth, policies, market demand etc. This involves not only the development of new appropriate technologies but also innovations in social and cultural terms.

These different criteria of sustainability may conflict and can be seen from different view points; those of the farmers, the community, the nation and the world. There may be conflicts between present and future needs; between satisfying immediate needs and conserving the resource base. The farmer may seek high income through high prices for farm products; the national government may give priority to sufficient food at prices, which the urban population can afford. Choices must continually be made in a never-ending search for balance between the conflicting interests. Therefore, well-functioning institutions and well deliberated policies are needed on all levels—from village to global in order to ensure sustainable development.

In agricultural development, raising production is often given primary attention. But there is an upper limit to the productivity of ecosystems. If this is exceeded, an ecosystem will degrade and may eventually collapse, and fewer people will be able to survive on the remaining resources than before. This implies that, when the limits on the supply side are reached, something has to be done on the demand side, *e.g.* other sources of income, emigration, lower consumption level, and population control. Production and consumption have to be brought into balance on an ecologically sustainable level. Although sustainability must be seen as a dynamic concept, which allows for the changing needs of an increasing global population (TAC/CGIAR, 1988), basic ecological principles oblige us to recognize that agricultural productivity has finite limits.

Why has the concept of sustainability gained increasing importance with reference to agricultural development? This becomes evident if we take a look at the present situation of world agriculture. The goal of sustainable agriculture is to feed the expanding population while farming in an economically sound and regenerative way. Economically viable system that minimizes the purchase of off farm inputs such as pesticides and fertilizers and rely on on-farm renewable resources, form the important factor in sustainable agriculture. It emphasizes soil building practices through crop residues, animal manures, green manures, etc., Nature pest control and crop rotations with N fixing legumes ensure substitution of external resources by internal resources, reduce production costs and are ecologically sound. Modern agricultural systems are capital intensive. Economic returns require use of high level of inputs. Injudicious use of input leads to environmental pollution. Such system does not endure long. A farming system to be sustainable should have the capacity to endure indefinitely. Therefore the ultimate goal of sustainable agriculture is “*to develop farming system that are: (a) productive, (b) profitable, (c) conserve the natural resource base, (d) protect the environment, and (e) enhance soil health and safety over a long term*”. Hence, this can be referred as *Eco-friendly Agriculture*.

17.3.3 Sustainability through Farming Systems

Two farming systems have been proposed for enduring sustainability. They are:

17.3.3.1 **Low external input sustainable Agriculture or Low input sustainable Agriculture (LEISA/LISA)**

It means Minimal use of external production inputs. In view of the limited access of most farmers to artificial external inputs, the limited value of these inputs under LEIA conditions, the ecological and social threats of ‘green revolution’ technology and the dangers of production on nonrenewable energy sources, the strong emphasis on High External Input Agriculture (HEIA) in agricultural development

must be questioned. However, it is also open to question whether it will be possible to raise world food production sufficiently without the use of such external inputs. Besides, natural as opposed to artificial inputs can also have detrimental environmental effects.

LEISA is an option which is feasible for a large number of farmers and which can complement other forms of agricultural production. As most farmers are not in a position to use artificial inputs or can use them only in small quantities, it is necessary to concentrate on technologies that make efficient use of local resources. Also, those farmers who now practice HEIA could reduce contamination and costs and increase the efficiency of the external inputs by applying some LEISA techniques. It is important that the agro-ecological knowledge of both scientists and farmers can be applied, so that internal and external inputs can be combined in such a way that the natural resources are conserved and enhanced. Productivity and security are increased and negative environmental effects are avoided.

A. LEISA refers to those forms of agriculture that

- Seek to optimize the use of locally available resources by combining the different components of the farm system, *i.e.*, plants, animals, soil, water, climate and people, so that they complement each other and have the greatest possible synergetic effects.
- Seek ways of using external inputs only to the extent that they are needed to provide elements that are deficient in the ecosystem and to enhance available biological, physical and human resources. In using external inputs, attention is given mainly to maximum recycling and minimum detrimental impact on the environment.
- LEISA does not aim at maximum production of short duration but rather at a stable and adequate production level over the long term. LEISA seeks to maintain and, where possible, enhance the natural resources and make maximum use of natural processes. Where part of the production is marketed, opportunities are sought to regain the nutrients brought to the market.

Numerous developing countries are now implementing so-called structural adjustment programs that involve policies such as devaluation of exchange rates, reduction of government spending and intervention, reduction of subsidies and removal of price controls. In this way, the demand for imports is to be curtailed and the purchase of local goods stimulated, so as to reduce the balance of payment and government deficits and to promote national economic growth. LEISA appears to fit within this context, as it is less demanding on imports and credits than the conventional approach to agricultural development. At farm, regional and national level, LEISA implies the need for closely monitoring and carefully managing flows of nutrients, water and energy in order to achieve a balance at a high level of production. Management principles include harvesting water and nutrients from the watershed, recycling nutrients within the farm, managing nutrient flow from farm to consumers and back again, using aquifer water judiciously, and using renewable sources of energy. As these flows are not confined by farm boundaries, LEISA requires management not only at farm level but also at district, regional, national and even international levels. At each level, technologies are sought to make the flow cycle as short as possible and to balance the flows. In this book, the focus is on practices that can be applied at farm level. Questions related to techniques and system at village level and above are equally important, but should be addressed in a separate study.

LEISA incorporates the best components of indigenous farmers' knowledge and practices; ecologically sound agriculture developed elsewhere, conventional science and new approaches in science (*e.g.*, systems approach, agro-ecology, biotechnology). Thus, conventional science has served mainly HEIA, but the contributions could make to LEIA should be explored to the full. LEISA practices must be developed within each ecological and socioeconomic system. The specific strategies and techniques

will vary accordingly and will be innumerable. The experience thus far of developing LEISA systems cannot provide universal, ready-made answers for the problems of farmers in other areas, but can provide some indications of principles and promising possibilities.

The process of combining local farmers' knowledge and skills with those of external agents to develop site-specific and socio economically adapted farming techniques has been given the name 'participatory Technology Development' (PTD). Farmers work together with professionals from outside their community (*e.g.*, extension workers, researchers etc.) in identifying, generating, testing and applying new techniques. PTD seeks to strengthen the existing experimental capacity of farmers, and to encourage continuation of the innovation process under local control (Haverkort, *et al.*, 1988). The experience of combining indigenous and scientific knowledge through a process of PTD indicates strongly that it is indeed possible to transform LEIA to LEISA (Low External-Input and Sustainable Agriculture). This approach to agricultural development appears to be better adapted to the needs and opportunities of LEIA farmers and to fit better into their cultural context than the conventional approach.

B. Sustainable agroecosystems

An alternative to the chemical dependence is to maximize the contributions of bio diversity to pest control and nutrient cycling and to attain optimal productivity with minimal inputs. Edwards and Grove (1991) proposed an analogous term for management of nutrients, integrated nutrient management. This approach capitalizes the adaptive features of traditional systems and incorporates additional advantages of conventional and innovative technology. It is important to recognize a strong link between the availability of organic matter and both bio diversity and nutrient cycling (Palm *et al.*, 1987). The practice in many developing countries of removing organic matter from the land for fuel and other purposes is a serious constraint to long-term sustainability (Oram, 1988). The most sustainable farming practices and components of the man managed bio diversity can be developed only by understanding the functions of the agro ecosystem and low social and economic conditions of the farmers and their climatic and environments impact upon overall crop and animal productivity. No matter how well the agro ecosystem functions biologically, it is sustainable only if it is socially and economically sound (Altieri, 1987).

Advantages

- Production costs are low,
- Overall risk of the farmer is considerably reduced,
- Pollution of water is avoided,
- Healthy food very little or no pesticide residue is ensured,
- Ensure both short and long term profitability.

Disadvantages

Continuation of LEISA will perpetuate a vicious circle of "low input-low yields" which the third world countries with even increasing population cannot afford. The solution for this is the optimal input farming which will meet the requirement of sustainability with the promise of low input/unit of output. It lays emphasis on law of diminishing returns.

17.3.3.2 Organic Farming

A. Why organic farming?

Need for more intensive and economic agriculture production led to wide use of high doses of concentrated chemical fertilizer but insufficient use of organics led to negative results, decrease in soil fertility

and soil structure. Chemical fertilisers and pesticides pollute our air and water. Agricultural chemicals, including hormones and antibiotics leave residues in food that may cause cancer or genetic damage. Other aspects of food quality have also changed for the worse. Further soil and energy resources are being depleted. Instead of recycling our wastes back into the land as fertiliser, we allow them to pollute our water. We use non-renewable energy resources to produce artificial fertiliser. In the future we may be forced to make radical adjustments in such agricultural practices. Thus organic farming requires the total elimination of the most damaging chemicals. Such restrictions would presumably satisfy most concern about pollution and human health. High-yields of crops are heavily dependent on use of chemical fertilizers. But in long run many problems are encountered.

The adverse effect of continued use of high analysis NPK can be summarized as follows:

- The occurrence of Zn and S deficiencies in many rice growing areas.
- Adverse effect on soil biotic life, particularly if the soil is acid.

B. Objectives of organic and conventional farming

It can be summarized as follows:

<i>Organic farming</i>	<i>Conventional farming</i>
<p>A. Organization</p> <ol style="list-style-type: none"> 1. Ecological orientation, second economy, efficient labour input. 2. Diversification, balanced combination of enterprises. 3. Stability due to diversification. <p>B. Production</p> <ol style="list-style-type: none"> 1. Cycle of nutrients within the farm, predominantly farm produced materials. 2. Weed control by crop rotation and cultural practices. 3. Pest control based on inoffensive substances. 4. Housing of livestock for production and health. <p>C. Mode of influencing life processes</p> <ol style="list-style-type: none"> 1. Production is integrated into environment, building healthy landscapes. 2. Balanced conditions for plants and animals; few deficiencies need to be corrected. <p>D. Social Values</p> <ol style="list-style-type: none"> 1. Optimum input/output ratio. 2. No pollution. 3. Maximum conservation of soils, water quality and wild life. 4. Holistic approach. 	<p>Economical orientation mechanization, minimising labour input.</p> <p>Specialisation, disproportionate development of enterprises.</p> <p>Programme based on market.</p> <p>Supplementing nutrients, predominantly bought in fertilizer.</p> <p>Weed control by herbicides.</p> <p>Pest control by pesticides.</p> <p>Livestock rarely combined.</p> <p>Emancipation of enterprises from their environment by chemical and technical manipulation.</p> <p>Excessive fertilisation, necessitating frequent correction of nutrient deficiencies.</p> <p>Low input/output ratio.</p> <p>Considerable pollution worldwide.</p> <p>Using up soil fertility often resulting in erosion and losses in water quality and wildlife.</p> <p>Economic motivation.</p>

C. Organic Vs. Natural farming

There is a misconception that organic farming is merely to say “no” to chemicalism. But apart from restricting and to the extent possible eliminating chemicals (Pesticides and fertilizers) it has something else also to convey. One who understands the whole concept of organic farming will be certainly inspired by it.

The differences between organic farming and natural farming (based on natural principles) are given below:

<i>Natural farming</i>	<i>Organic farming</i>
<ul style="list-style-type: none"> * It is not alternative system of farming but part of the philosophy of life involving continuous search to know the true spirit and form of nature. * Totally eliminates all the components of modern farming. * It indicates a ‘Do-nothing’ approach <p>The essential principles are:</p> <ul style="list-style-type: none"> * No cultivation * No chemical fertilisers * No weeding * No plant protection. 	<p>In many respects close to natural farming, but does not have the philosophical overtone of natural farming.</p> <p>Organic farming does not totally exclude elements of modern farming. It involves limited and essential</p> <ul style="list-style-type: none"> – ploughing – hoeing, weeding, and – use of chemicals <p>It indicates a soil building programme—more intensive style of natural farming. Application of natural plant protection chemicals (which are not inorganic derivatives) use of organic manures (instead of chemical fertilisers) are permitted.</p> <p>Principal elements to be considered in practising organic farming are:</p> <ul style="list-style-type: none"> (i) maintaining a living soil. (ii) making available all the essential nutrients. (iii) organic mulching.

Nonetheless, the principles and practices that lie behind these terms are essentially similar. The objectives of organic agriculture are concisely expressed in the standard document of the International Federation of Organic Agriculture Movement (IFOAM) as follows:

- to produce food of high nutritional quality in sufficient quantity
- to work with natural systems rather than seeking to dominate them
- to encourage and enhance the biological cycles within farming system involving micro organisms, soil flora and fauna, plants and animals
- to maintain and increase the long term fertility of soils
- to use as far as possible renewable resources in locally organised agricultural systems
- to work as much as possible within a closed system with regard to organic matter and nutrient elements
- to give all livestock, conditions of life that allow them to perform all aspect of their innate behaviour
- to avoid all forms of pollution that may result from agricultural techniques

- to maintain the genetic diversity of the agricultural system and its surroundings, including the protection of plant and wildlife habitats
- to allow agricultural producers an adequate return and satisfaction from their work including a safe working environment, and
- to consider the wider social and ecological impact of the farming system.

In general, the problems ascribed to be created by the use of chemical fertilizers include high energy cost, monocropping, loss of productivity and water pollution.

1. Energy use: The increased use of fertilizers has been possible due to increase of energy input for fertiliser production. Although in developing countries about 70 per cent of the commercial energy used in agriculture goes in the production of chemical fertilisers as against 35 per cent in developed countries; total consumption is more in developed countries which account for only 37 per cent of the total agricultural area. Thus, the scope for reducing energy consumption in developing countries is marginal.

2. Monocropping: The crop yields increased greatly in developed countries over last 50 years and in developing countries during last 20 years. Most of these are due to development of varieties, which respond well to fertilisers. The different types of cropping systems practised in traditional agriculture have given way to system involving only few crops, which are highly nutrient depleting. The legumes, grasses and millets which are regular components of cropping systems in Indian agriculture have largely been phased out in highly productive areas and replaced by high yielding rice, wheat, sugarcane, etc. This has created the problems of soil erosion and disturbances to soil and wild life habitats.

3. Imbalance of nutrients and decrease in soil productivity: There is increasing concern on the role of fertilizers in maintaining long term soil productivity. In intensive agriculture with high yielding crop varieties, crop yields will be drastically reduced due to decline in the soil nutrient reserves. Long term use of only chemical (N) fertilisers also has adverse effect on soil physical properties such as bulk density, hydraulic conductivity and stability of aggregates. The deterioration in soil due to intensive cultivation can be easily arrested by the balanced use of bulky organic measure such as FYM and compost.

4. Pollution: Greater use of synthetic N and P fertilisers has given rise to concern amongst environmental and health specialists. The N fertilisers create health and ecological hazards due to presence of excess nitrate in drinking water; eutrophication of lakes and streams and depletion of stratospheric ozone due to nitrous oxide production from denitrification. The continued application of P fertilisers to agricultural lands can result in the build up of trace metal contaminants such as arsenic and cadmium contained in the fertiliser. Although the mobility of P in soil is low, transport of P from agricultural soils to aquatic environment in runoff can result in deterioration of water quality.

So to avoid the toxic effects we can go for biological agriculture which attempts to provide a balanced environment, in which the maintenance of soil fertility and control of pests and diseases are achieved by the enhancement of natural processes and cycles, with only moderate inputs of energy and resources while maintaining optimum productivity.

The rapidly growing population is also causing serious environmental problems and degrading natural resources that are essential to agriculture. Some of these problems are discussed below:

1. Soil erosion: In recent decades more and more forest and grasslands have been cleared and converted to crop fields. At the same time effective traditional soil conservation techniques have been abandoned. Thus soil erosion has become a serious and growing threat to sustained agricultural productivity. Man's increasing impact on the environment is resulted in a world-wide tendency towards degradation and erosion of soils. In Britain, 44 per cent of the arable land is subjected to erosion. It is

not unusual to find fields that lose 20 t/ha/year. In worst areas the loss is as high as 50 tonnes per ha in a single year. Soil Scientists estimate that if fields repeatedly lose more than 2 t per ha, yields of cereals would fall permanently. In China the annual erosion rate is 50–70 t/ha/year and in India, it is about 16 t/ha/year. After years of intensive cultivation, the thickness of top soil has reduced from 60–70 cm to only 20–30 cm. Approximately 0.5 cm of top soil is lost annually. The seriousness of this situation becomes apparent when it is recognised that soil is formed only at approximately 1 t/ha/yr.

2. Decrease in organic matter: Severe erosion results in reduction of organic matter in the soil, the more organic matter in the soil the more stable it is. A stable soil is also more porous allowing water to drain rapidly from the surface. Water that does not penetrate the soil, runs off the surface taking soil with it. Changing in farming techniques led to depletion of organic matter in the soils. Farmers have ceased rotating grass with crops. Pasture crops maintain or even raise the amount of organic matter in the soil whereas continuous arable cropping tends to reduce these levels. Also inorganic fertilisers have largely replaced organic manures. Grass crops not only increase the amount of organic matter but also permanently cover the ground affording greater protection to erosion by rain. Organic farming techniques will help to increase the organic matter content of soils, thus reducing the bulk density and decreasing compaction. There can be effective conservation systems since they provide soil cover during most of the year and with the greater use of rotations and green manure crops, crop residues and legumes, there is an increased emphasis on manure as a source of soil fertility. So unlike under conventional and monocropping systems, due to maintenance of crop cover during greater part of the year there is a little runoff and erosion. Modern concept of conservation tillage is effective to reduce erosion but it employs excessive use of herbicides, which are hazardous to our environment.

Soil organic matter is one of the important components of the soil. The dead plant and animal remains and dead microbial tissues form the main source of soil organic matter. Various organic matter like farmyard manure, compost, green manure etc. that are added to the soil from time to time further add to the store of organic matter. These added organic undergo a series of microbial decompositions and finally humus is formed (light bulky amorphous material of dark brown to black colour). Tropical soils are generally low in organic matter content. Sandy soils contain less organic matter than loams and loams contain less than clay soils. The low organic matter is primarily due to climate particularly due to high temperature and secondarily due to cultural practices. In tropical and sub-tropical regions although much organic matter is produced, it decays very rapidly. Whatever organic matter added to the soils will be decomposed (over 90 per cent in a year) and hence, it is Herculean task to raise the organic matter content of the soil. In cultivatable soils, the organic matter content ranges from less than 1 per cent to 15 per cent. The peat soils contain more than 90 per cent organic matter.

D. Concept and Definition

The concept of organic agriculture has been perceived differently by different people. To most of them, it implies the use of organic manures and natural methods of plant protection instead of using synthetic fertilisers and pesticides. It is regarded by some as farming involving the integrated use of fertilisers and organic manures as well as of chemicals and natural inputs for plant protection. In either case the concept has been understood only partially.

Organic agriculture has been defined differently, but the description offered by Lampkin (1990) appears to be most comprehensive one covering all essential features. As per this description, organic agriculture is a production system, which avoids or largely excludes the use of synthetic compounded fertilisers, pesticides, growth regulators and livestock feed additives. To the maximum extent feasible, organic farming system rely on crop rotations, crop residues, animal manures, legumes, green manures, off-farming organic wastes and aspect of biological pest control to maintain soil productivity and tilth,

to supply plant nutrients and to control insects, weeds and other pests. The concept of soil as living system that develops the activities of beneficial organisms is central to the definition.

Organic agriculture does not imply the simple replacement of synthetic fertilisers and other chemical inputs with organic inputs and biologically active formulations. Instead, it envisages a comprehensive management approach to improve the health of underlying productivity of the soil. In a healthy soil, the biotic and abiotic components covering organic matter including soil life, mineral particles, soil air and water exist in a stage of dynamic equilibrium and regulate the ecosystem processes in mutual harmony by complementing and supplementing each other. When the soil is in good health, the population of soil fauna and flora multiplies rapidly which, in turn, will sustain the bio-chemical process of dissolution and synthesis at a high rate. This state of soil life and the associated organic transformations will enhance the regenerative capacity of the soil and make it resilient to absorb the effects of climatic factors and occasional failures in agronomic management.

The success of organic agriculture depends to a great extent on the efficiency of agronomic management adopted to stimulate and augment the underlying productivity of the soil resource. In this context, the concept of agro-ecosystem becomes relevant. A farming system unit is treated as a agro-ecosystem when it attains the semblance of a forest ecosystem in species diversity and multiplicity. The adoption of sequence and mixed cropping models in the presence of compatible species of nitrogen fixing trees with or without the association of livestock components makes the agro-ecosystem benefit from the positive interaction and the stimulated cycling mechanisms. As a consequence, the system slowly achieves self-regulation and stability. Agriculture production attained at this stage will be engaging without eroding or deteriorating the natural resource base.

As the OAS derives its strength from the primary education capacity of the soil and complimentary interaction among the components of the system, the use of chemical inputs either for soil fertility management or for plant protection is excluded. This renders the system free from the pollution problems usually associated with the use of such inputs. For achieving marked improvement in soil productivity and for sustaining optimum levels of biological production, OAS lays emphasis on appropriate cropping and farming models, ensuring on-farm diversity and nutrient cycling, conservation and use of organic/biological sources of nutrients, cultural practices conducive to the conservation of soil and water resources and natural and or biological methods of pest and disease suppression.

With an understanding of the principles of organic agriculture, a straight and simple definition to the concept can be suggested. Organic agriculture is a farming system devoid of chemical inputs, in which the biological potential of the soil and underground water resources are conserved and protected from the natural and human induced degradation or depletion by adopting suitable cropping models including agro forestry and methods of organic replenishment; besides natural and biological means are used for pest and disease management by which the soil life and beneficial interaction are stimulated and sustained. The system achieves self regulation and stability as well as capacity to produce agricultural outputs at levels, which are profitable and enduring over time, and, at the same time, consistent with the carrying capacity of the managed agro-ecosystem.

There are also different opinions on nomenclature of organic farming. Some call it as ecofarming *i.e.*, farming in relation to ecosystem. Others prefer the term biological farming (farming in relation to biological diversity); yet others prefer the term bio-dynamic farming (biologically dynamic and ecologically sound and sustainable farming) or macrobiotic agriculture (agriculture in relation to macro-fauna). Whatever be the name, the basic point is that organic farming is the farming based on natural principles, which alone are sustainable. According to Fantilanan (1990), organic farming is a matter of giving back to nature what we take from it. It is safe, inexpensive, profitable and sensible. Organic farming is not mere non-chemicalism in agriculture; it is a system of farming based on integral

relationship. So, one should know the relationships among soil, water, plants, and microflora and the overall relationship between plants and animal kingdom, of which, man is the apex animal. It is the totality of these relationship, which is the backbone of organic farming.

Organic farming does not totally exclude the elements of modern agriculture and varying agro climatic conditions do need input from the current technological advances. It is basically simple as it abhors excessive ploughing, hoeing, weeding and application of plant protection chemicals and fertilizers. The principal elements to be considered while practising organic farming are:

- maintaining a living soil
- making available all the essential nutrients
- organic mulching for conservation, and
- attaining sustainable high yield

Agricultural practices followed in organic farming are governed by the principles of ecology and are within the ecological means. Limited experience shows that this form of natural farming is the basis for sustainable agriculture and could be highly productive. It should not be discontinued for reversion to inefficient and less productive farming systems.

Hence, organic farming is a production system, which avoids or largely excludes the use of synthetic compound fertilizers, pesticides, growth regulators and livestock feed additives. To the maximum extent feasible, it relies on crop rotation, crop residues, animal manures, legumes, green manures, off-farming organic wastes and aspect of biological pest control to maintain soil productivity and tilth, to supply plant nutrients and to control insects, weeds and other pests. In this system most of the ill effects of modern day agriculture is avoided because:

- Use of agrochemical is forbidden.
- There is emphasis in building up of organic matter in the soil, thereby activate biological activity.
- Soil is treated as living organism.

Emphasis is given on

- Maintenance of favourable soil structure.
- Development and use of crop rotation that improves and prevents soil erosion.
- Biological control of pests, diseases and weeds.

E. Principles of organic agriculture systems

Organic agriculture systems are based on three strongly interrelated principles under autonomous ecosystem management: mixed farming, crop rotation and organic cycle optimization. The common understanding of agriculture production in all types of organic agriculture is managing the production capacity of an agro-ecosystem. The process of extreme specialization propagated by the green revolution led to the destruction of mixed and diversified farming and ecological buffer systems. The function of this autonomous ecosystem management is to meet the need for food and fibres on the local ecological carrying capacity.

(a) **Mixed farming:** In organic agriculture system, one strives for appropriate diversification, which ideally means mixed farming, or the integration of crop and livestock production on the farm. In this way, cyclic processes and interactions in the agro-ecosystem can be optimised, like using crop residues in animal husbandry and manure for crop production. Diversification of species biotypes and land use as a means to optimize the stability of the agro-ecosystem is another way to indicate the mixed farming concept. The synergistic concept among plants, animals, soil and biosphere support this idea.

(b) **Crop rotation:** Within the mixed farm setting, crop rotation takes place as the second principle of organic agriculture. Besides, the classical rotation involving one crop per field per season, intercropping, mixed cropping and under sowing are other options to optimize interactions. In addition to plant functions, other important advantages such as weed suppression, reduction in soil-borne insect pests and diseases, complimentary in nutrient demand, nutrient catching and soil covering can be mentioned.

(c) **Organic cycle optimisation:** Each field, farm, or region contains a given quantity of nutrients. Management should be used in such a way that optimal use is made of this finite amount. This means that nutrients should be recycled and used a number of times in different forms. Second, care should be taken that only a minimum amount of nutrients actually leave the system so that 'import' nutrients can be restricted. Third, the quantity of nutrients available to plants and animals can be increased within the system by activating the edaphon, resulting in increased weathering of parent material.

F. Concept of organic farming

It envisages a comprehensive management approach to improve the health underlying productivity of the soil. Organic farming is a matter of giving back to nature what we take from it. It is cheap, inexpensive, profitable and sensible.

G. Components of organic farming

They are (i) organic manures, (ii) non-chemical weed control measures, and (iii) biological pest and disease management.

1. **Organic manures:** Organic materials such as farmyard manure, biogas, slurry, composts, straw or other crop residues, biofertilisers, green manures and cover crop can substitute for inorganic fertilisers to maintain the environmental quality. In addition, the organic farmers can also use seaweeds and fish manures and some permitted fertilisers like basic-slag and rock phosphate. The use of organic manures will increase the organic matter content and water holding capacity of the soil. Erosion is reduced by organic manures. Crop rotation with legumes adds to soil fertility. Green manure provides the nutrients and improves the soil.
2. **Non-chemical weed control measures:** Compared to conventional farmers, the organic farmers use more of mechanical cultivation of row crops to reduce the weed menace. No herbicides are applied as they lead to environmental pollution.
3. **Biological pest management:** The control of insect pests and pathogens is one of the most challenging jobs in tropical and sub-tropical agriculture. Here again non-chemical, biological pest management is encouraged. The conservation of natural enemies of pests is important for minimising the use of chemical pesticides and for avoiding multiplication of insecticides-resistant pests. Botanical pesticides such as those derived from neem could be used. Selective microbial pesticides offer particular promise, of which strains of *Bacillus thuringiensis* is an example.

H. Essential characteristics of organic farming

The most important characteristics are as follows:

- Maximal but sustainable use of local resources.
- Minimal use of purchased inputs, only as complementary to local resources.
- Ensuring the basic biological functions of soil-water-nutrients-humus.
- Maintaining a diversity of plant and animal species as a basis for ecological balance and economic stability.
- Creating an attractive overall landscape, which gives satisfaction to the local people.

- Increasing crop and animal diversity in the form of polycultures, agroforestry systems, integrated crop/livestock systems, etc. to minimise risk.

Methods in organic agriculture are less intensive in terms of synthetic and other external inputs compared to the conventional farming methods, but are much more intensive from a biological point of view. Organic agriculture systems include approaches and methods like organic, biodynamic, regenerative, nature farming and permaculture. These were developed during the last 50 years. Although there are some differences among these approaches, the common understanding is that practising organic agriculture is managing the agro-ecosystem as an autonomous system, based on the primary production capacity of the soil under the given agro-climatic conditions. Agro-ecosystem management implies treating the system, on any scale, as a living organism supporting its own vital potential for biomass and animal production, along with biological mechanisms for mineral balancing, soil improvement and pest control.

I. Possibility of organic farming in India

By 2010 India needs 280 million tones of food grains and the nutrient requirement will be 34 million tones of NPK. Estimate indicates that organic residues can provide 7.1, 3.0 and 7.6 million tones of NPK respectively. Even if 50% of these organic residues are recycled, sustainable crop productivity can be achieved with less pollution and better quality food products.

J. Advantages of organic farming

- Organic manures produce optimal conditions in the soil for high yields and good quality crops.
- They supply all the nutrients required by the plant (NPK, secondary and micronutrients).
- They improve plant growth and physiological activities of plants.
- They improve the soil physical properties such as granulation and good tilth, giving good aeration, easy root penetration and improved water holding capacity. The fibrous portion of the organic matter with its high carbon content promotes soil aggregation to improve the permeability and aeration of clay soils while its ability to absorb moisture helps in the granulation of sandy soils and improves their water holding capacity. The carbon in the organic matter is the source of energy for microbes, which help in aggregation.
- They improve the soil chemical properties such as supply and retention of soil nutrients and promote favourable chemical reactions.
- They reduce the need for purchased inputs.
- Most of the organic manures are wastes or by-products, which on accumulation may lead to pollution. By way of utilizing them for organic farming, pollution is minimized.
- Organic fertilisers are considered as complete plant food. Organic matter restores the pH of the soil, which may become acid due to continuous application of chemical fertilisers.
- Organically grown crops are believed to provide more healthy and nutritional superior food for man and animals than those grown with commercial fertilisers.
- Organically grown plants are more resistant to pest and diseases, and hence few or two chemical sprays or other protective treatments are required.
- There is an increasing consumer demand for agricultural produces, which are free of toxic chemical residues. In developed countries consumers are willing to pay more organic foods.
- Organic farming helps to avoid chain reaction in the environment from chemical sprays and dusts.
- Organic farming helps to prevent environmental degradation and can be used to regenerate degraded areas.

- Since the basic aim is diversification of crops, much more secure income can be obtained than when they rely on only one crop or enterprise.

K. Limitations of organic farming

- Maintenance of organic carbon is difficult in tropical agriculture due to high temperature coupled with conventional tillage where the organic carbon is easily oxidized.
- Sudden shift to organic farming would reduce crop yields (low yields).
- Take time to buildup soil fertility and balance the ecosystem. (Organic manure and fertilizer combinely added to field increase yield doubly).
- Non-availability of organic manures, crop residues, bio-fertilizers and bio-pesticides.
- Transport of organic manures is difficult due to bulkiness.
- Absence of premium price of organic farming produces in India.
- In India, it is recognized that organic farming is expensive and labour intensive.
- Lack of technical know-how (like timely and effective control of weeds, insects and diseases).
- Lack of awareness among farmers.

Initially there may be some barriers, which inhibit the farmers from adopting organic farming. Land resources can move freely from organic farming to conventional farming; they do not move freely in the reverse direction. In changing over to organic farming an initial crop loss generally occurs, particularly if it is rapid. Organic farmers may be afraid to enter the new market without adequate government support. Hence package of practices involving organic farming practices are to be spread among the farmers and economics (cost-benefit ratio) be made available.

L. Options of organic farming

There are at least three options available in organic farming. They are:

1. Pure organic farming
2. Integrated green revolution farming
3. Integrated farming system (IFS)

1. Pure organic farming: Pure organic farming is done by the use of organic manures, biofertilizers and bio-pesticides and completely avoiding inorganic fertilizers and pesticides. This excludes the use of inorganics, both fertilisers and pesticides, but advocates the use of organic manures and biological pest control methods. By the year 2000 A.D., to meet the demands of the population of a billion people food production has to reach 230 million tonnes needing 24 million tonnes of NPK fertilizers and 2 million tonnes of organics. If the entire NPK requirement is to be supplied in the form of organics, either as farm or town compost or green manure, the quantity of organics required will be huge. But, large potential of organic resources remains untapped in the country. Nearly 750 million tonnes of cow dung, 250 million tonnes of buffalo manure and nearly 100–115 million tonnes of crop residues are available. The nutrient value of these organics produced annually is in the order of 2.5, 2.0 and 3 million tonnes of NPK equivalent respectively. Besides, hundreds of millions tonnes of rural and urban compost could be collected.

2. Integrated green revolution farming: Integrated green revolution farming is a high input technology green revolution farming involving INM and IPM. Here chemical fertilizers and pesticides are used apart from organics, bio fertilizers and bio-control agents depending on the necessity. Under this option, the basic trends of the green revolution such as intensive use of external inputs, increased irrigation, development of high yielding crop varieties and hybrids

and mechanisation of labour are retained. But much greater on the use of these inputs is obtained as to limit damage to the environment and human health. For this purpose, some organic techniques are developed and combined with the high input technology in order to create integrated systems such as 'Integrated nutrient management' (INM), 'Integrated pest management' (IPM) and biological control methods which reduce the need for chemicals. Modern biotechnology is also employed to develop higher yielding, pest resistant crop varieties. This option is possible for conditions, including fertile soils, climate and availability of necessary infrastructure facilities like irrigation.

- 3. Integrated farming system:** The third option in organic farming is the low input organic farming, in which the farmers have to depend on local resources and ecological processes, recycling agricultural wastes and crop residues. Integrated Farming System (IFS) is a resource management strategy to achieve economic and sustained agricultural production through two or more interrelated or inter dependent agricultural and allied enterprises, to meet diverse requirements of the farm household, while preserving the resources base (soil fertility) and maintaining a high environmental quality. It is a Low Input Organic Farming (LIOF) in which the local resources are effectively recycled. For example, Cropping (0.96 ha); Fishery (0.04 ha) + poultry in wetlands. Crops, dairy, biogas, trees in garden lands. Crops, trees and goats in dry-farming areas.

Capital intensive green revolution techniques are simply not a feasible alternative for the poorest of the 1.4 billion farmers who live on the tropical region with ecologically, geographically and developmentally less favourable production conditions. In order to cover such risks and to ensure sustainability in their small holdings, the age-old mixed farming systems are prudently integrated with the cropping system.

M. Scope of bio-fertilizers in organic farming

In the context of search for alternate sources for sustaining soil fertility through renewable sources, harnessing of bacteria and other microorganisms for fixing N and efficient utilization of N assumes greater importance. An about 139 million tone of N per annum is fixed globally by microorganisms. Research shows that 25% of the N and P could be met through the bio-fertilizers for the cultivated crops in our country. Efforts must be taken to cover the entire cropping area with bio fertilizers by alleviating the constraints in its production and commercialization. Thus bio-fertilizers can play a significant role in the nutrient management of crops and in ushering organic farming in the near future.

N. Management of organic farming

Management of organic farming system involves:

- Organization of crop and livestock production, and the management of farm resources in such a way that it harmonizes rather than conflicts with natural systems.
- Achievement of a closed cycle to the greatest extent possible between soil, plants, animals and people and an avoidance of environmental pollution.
- Maintenance of soil fertility for optimum production, relying primarily on renewable resources.
- Reduction of pest and disease incidence through a carefully designed farm rotation and enterprise structure; use of resistant varieties; the encouragement of beneficial pest predators; and the use of other biological pest control techniques.
- Use of forms of animal husbandry which respect the welfare and behavioural needs of farm livestock.

- Use of appropriate farm machinery and cultivation techniques, which reduces non-renewable resource consumption.
- Enhancement of the environment in such a way that wildlife flourishes and it is enjoyable for people both working within the system and viewing it from outside.

These principles will lead to a wider definition of quality than is usually given to food. The following categories have been suggested:

- **External quality:** freedom from pest and disease damage, freshness and colour.
- **Technological quality:** Improved properties of storage and processing.
- **Nutritional/physiological quality:** Increased content of valuable nutrients such as proteins and vitamins, and the absence of detrimental substances such as nitrates and other agricultural chemical residues.
- Environmental quality of the system of production, with regard to the organisation of crop and live stock and management of farm resources, in such a way that they harmonize rather than conflict with natural systems.

17.4 INDICES OF SUSTAINABILITY

Quantification of sustainability is essential to objectively assess the impact of management systems on actual and potential productivity, and on environment. One can assess sustainability or several indices (Lal, 1994). Indices may be simple involving one parameter or complex involving several parameters. Although general principles may be the same, there indices must be fine-tuned and adapted under local environments. Some indices of sustainability include the following:

1. **Productivity (P):** Production per unit of resource used can be assessed by, $P = P/R$; Where, P is productivity, P is total production and R is resource used.
2. **Total Factor Productivity (TFP):** It is defined as productivity per unit cost of all factors involved (Herdt, 1993).

$$TFP = \sum_{i=0}^n \frac{P}{(R_i \times C_i)}$$

where, P is total production, R is resource used and C is cost of the resource, and n is the number of resources used in achieving total production.

3. **Coefficient of sustainability (CS):** It is measure of change in soil properties in relation to production under specific management system (Lal, 1991).

$$Cs = F(O_i, O_d, O_m) t,$$

Where, Cs is coefficient of sustainability, O_i is output per unit that maximizes per capita productivity or profit, O_d is output per unit decline in the most limiting or non-renewable resource, O_m is the minimum assured output, and t is the time. The time scale is important and must be carefully selected.

4. **Index of sustainability (Is):** It is a measure of sustainability relating productivity to change in soil and environmental characteristics (Lal, 1993; Lal and Miller, 1993).

$$Is = f (P_i * S_i * W_i * C_i) t,$$

Where, Is index of sustainability, S_i is alteration in soil properties, W_i is change in water resources and quality, C_i is modification in climatic factor and t is time.

5. **Agricultural Sustainability (Ag.):** It is a broad-based index based on several parameters associated with agricultural production (Lal, 1993)

$$A_s = d (P_t * S_p * W_t * C_t) dt,$$

Where, A_s is agricultural sustainability, P_t is productivity per unit input of the limited or non-renewable resource, S_p is critical soil property of rooting depth, soil organic matter content, W_t is available water capacity including water quality, and C_t is climatic factor such as gaseous flux from agricultural activity and t is time.

17.4.1 Sustainability Coefficient (SC)

It is a complex and a multipurpose index based on a range of parameters, and is similar to A_s . It is defined as:

$$S_c + F (P_t * P_d * P_m) t$$

$$S_c = d(P_i * W_t * C_t) dt$$

Where, P_t is productivity per unit input of the limited resource, P_d is productivity per unit decline in soil property, S_c is critical level of soil property, W_t is soil water regime and quality, C_t is climatic factor, and t is time.

17.4.2 Crop Productivity as an Indicator of Sustainability

A measure of crop productivity is a good integrator of all soil, water, climatic and biotic factors. It is important to assess potential vis-à-vis actual productivity. In a science based management system, actual production exceeds potential production in soils of low inherent fertility and in harsh environments. The potential productivity, soils' productive potential within a biome, can be estimated by several models *e.g.*, CERES (Richie *et al.*, 1989) and Tropical soil Productivity calculator (Aune and Lal, 1994). If land availability is a limiting factor, appropriate indices of productivity are Land use Factor (L), Land Equivalent Ratio (LER), and Area Time Equivalent Ratio (ATER) etc.

Sustainability coefficient (S_c): It is a complex and a multipurpose index based on a range of parameters, and is similar to A_s . It is defined as:

$$S_c = f (P_t * P_d * P_m)t$$

$$S_c = d(P_i * W_t * C_t) dt$$

Where, P_t is productivity per unit input of the limited resource, p_d is productivity per unit decline in soil property, S_c is critical level of soil property, W_t is soil water regime and quality, C_t is climatic factor, and t is time.

The Land use factor (L) is defined as the ratio of cropping period C plus fallow period F to cropping period C (Okigbo, 1978).

$$L = C+F/C$$

The factor L is generally high for low intensity systems *e.g.*, shifting cultivation.

The LER is calculated as follows (Willey and Osiru, 1972):

$$LER = \sum_{i=1}^n \left(\frac{Y_i}{Y_m} \right)$$

Where, Y_i and Y_m are yields of component crops in the inter crop and monoculture system, respectively, and n is the number of crops involved.

Because crops involved vary widely in their maturity period, ATER index considers the crop duration (Hiebsch and Mc Collum, 1987).

$$ATER = \frac{1}{t} \sum_{i=1}^n \left(\frac{d.Y_i}{ym} \right)$$

Where, d is the growth period of the crop in days and t is the time in days for which the field remained occupied *i.e.*, the growth period of the longest duration crop. Numerical values of ATER approaches that of LER for a mixture consisting of crops of approximately identical growth periods *i.e.*, when t=dI. In comparison, productivity can also be expressed terms of the resources use efficiency of the most limiting resource *e.g.*, water, nutrients, energy or labour.

17.5 INPUT MANAGEMENT FOR SUSTAINABLE AGRICULTURAL SYSTEMS

The concept of two global commonalities—biological diversity and nutrient cycling among agro ecosystems is supported by the literature on ecosystems and their management anecdotal account of indigenous practices, and the rapidly emerging literature on agro ecology. Organic matter is the basis of all bio-geo chemical cycles. The fundamental issues concerning efficient use of organic matter are leakage of nutrients from agro ecosystems and the rates of decomposition. Organic matter and the nutrients if contains are lost from soils by run off and mineralization (Tiuy, 1990), both of which can be controlled by appropriate tillage practices (Campbell *et. al.*, 1995); Lal *et. al.*, 1994). Loss of nutrients to mineralization is also controlled by assuring sufficient inputs of plant or animal material to maintain the soil organic matter (SOM) reserves (Woodmansee, 1984). Legumes are important in maintaining SOM and increasing soil N suffer. In addition, they prefect the soil from run off water and wind erosion and improve infiltration, agro forestry systems use leguminous and other trees to provide alternative crops (Steppler and Lundgren 1988), produce animal forage and fuel, recycle nutrients for crop use and project soil from wind and water erosion (Altieri, 1987).

Plant biodiversity plays an important role in pest, disease, and weed management. Crop rotations are effective in controlling pests, diseases and weeds (Altieri, 1987). Living mulches control weeds and minimize the need for herbicides (Regnion and Jahnke, 1990); Increases in structural diversity within the crop canopy leads to greater diversity in insects and less damage from insect pests (Stinner and Blair, 1990). Integration of animals into Agro ecosystems offers further diversity and stability. Mc-Infire and Cryseels (1987) summarized the potential benefits of integration of crops and animals. Integration of animals facilitates nutrients movement and increases the opportunities for efficient nutrient management across the whole farm system. Animals increase overall net productivity of the farm and reduce environmental degradation by serving as alternatives to crops on the marginal areas of farms by utilizing crop residues as feed.

17.5.1 Optimizing Nutrient Availability

A very important condition for good plant growth and health and, indirectly, for good animal and human health is the timely provision of sufficient and balanced quantities of nutrients that can be taken up by the plant roots. Nutrient deficiencies and imbalances are main constraints to crop production, especially in regions with poor and very poor or alkaline soils. There is a constant flow of nutrients through the farm. Some of the nutrients are lost by export of products, erosion, leaching and volatilization. For example, it has been estimated that in Africa nutrient losses through soil erosions and other processes exceed application of artificial fertilizers (Stocking, 1986). If the farm is to remain productive it must be ensured that the amount of nutrients leaving the farm does not exceed the amount returned to it. In other words, over time, there must be a positive nutrient balance.

17.5.2 Micronutrient Deficiencies

Due to intensive cropping the micronutrients are removed to a considerable extent, which control various aspects of plant growth. A study at Ranchi, India revealed that applying looks NPK (10:25:25) per ha. Led to depletion of Zinc by 0.619/ha and copper by 0.49/ha. this can depress yields by up to 4t/ha in rice, 2 t/ha in wheat and 3.4 t/ha in maize. Also iron is a limiting factor in rice production in the new rice-wheat rotation evolved in the non-traditional rice growing areas of Punjab. One of the solutions to correct this micronutrient deficiencies is greater use of organic manures and multiple cropping with legumes. At Punjab Agricultural University, Ludhiana field experimental results proved that application of poultry manure, pig manure and farmyard manure were effective in meeting zinc requirements in a maize-wheat rotation. Also cultural practices such as prolonged submergence of the field can be used to tackle iron and manganese deficiencies (Sharma, 1985).

17.5.3 Limiting Nutrient Losses

Nutrient losses can be limited by:

- Recycling organic wastes by returning them to the field, either directly or treated (composted, fermented etc.).
- Applying organic and artificial fertilizers in such a way that nutrients are not leached by excessive rain or volatilized by high temperature or solar radiation.
- Reducing losses due to run-off and soil erosion.
- Minimizing nutrient losses due to biomass bussing.
- Reducing volatilization of nitrogen by denitrification under wet soil conditions.
- Avoiding leaching by using organic and artificial fertilizers, which release nutrients slowly, maintaining high humus content in the soil and intercropping plant species with different rooting depth.
- Limiting nutrient export in products by producing crops with relatively high economic value relative to nutrient content.

17.5.4 Use of Chemical Fertilizers

The use of chemical fertilizers is essential for obtaining high crop yields. However, many small landholders and resource-poor farmers cannot offer costly fertilizers. Most soils in the tropics are so deficient in primary nutrients that it is imperative that strategies be developed for adding them from outside the ecosystem. There is some potential for enhancing N supply by biological N fixation. Additional N and other nutrients must be supplied. The requirements for chemical fertilizers, however, can be reduced considerably by decreasing losses, recycling nutrients and through biological N fixation.

17.5.5 Nutrient Recycling

Nutrient recycling or regime is an important strategy for sustainable crop production. It involves returning nutrients removed by crops to the soil for further use. In addition, soil fauna (*e.g.*, earth worms, termites) also play an important role in recycling of plant nutrients. Growing deep-rooted crops is important in order to recycle nutrients from the sub soil by returning them through crop residue to the surface where the succeeding shallow rooted crops can use them. Use of mulches, incorporation of crop residues and animal waste, growing legumes as intercrops in cereals etc., can substantially reduce chemical fertilizer requirements.

17.5.6 Use of Crop Residues

Crop residues contain substantial quantities of plant nutrients. The beneficial effects of returning crop

residues as mulch on crop yields are well known (Akimbo and Lal, 1980 and Kang, 1993). These benefits are not only to the recycling of plant nutrients but also to improvements in soil moisture and temperature, enhancement of soil structure and soil erosion control. The nutrient composition of the crop residues of some of the important crops is given in Table 17.2.

Table 17.2. Nutrient Composition (%) of Crop residues of Major Crops grown in the tropics

<i>Crop/Species</i>	<i>N</i>	<i>P</i>	<i>K</i>
Cowpea straw	1.07	1.14	2.54
Cowpea leaves	1.99	0.19	2.20
Rice	0.58	0.10	1.38
Maize	0.59	0.31	1.31
Oil palm (Processed fiber)	1.24	0.10	0.36
Sesbania leaves	4.00	0.19	2.00
<i>Crotalaria spp</i>	2.89	0.29	0.72
<i>Tephrosia spp</i>	3.73	0.28	1.78
<i>Azolla spp</i>	3.68	0.20	0.11
<i>Typha spp</i>	1.37	0.21	2.38
Water hyacinth	2.04	0.37	3.40

Source: FAO, 1990.

17.5.7 Biological Nitrogen Fixation

Augmenting the nitrogen supply to crops through biological nitrogen fixation is a viable option for resource-poor farmers of the tropics. The amount of N fixed by legumes can range from 20–250 kg/ha/yr depending

Table 17.3. Quantities of N fixed by various Legume Crops

<i>Crop species</i>	<i>N fixed (kg/ha/yr)</i>
Alfalfa	78–222
Peanut	87–222
Cowpea	65–130
Field peas	174–195
Soybean	170–217
Birds foot	49–112
Chickpea	24–84
Common bean	70–124
Faba bean	77–250
Vetch	111
Ladino clover	164–187
Lentil	167–188
White lupin	193–247
<i>Sesbania spp.</i>	267

on the species, soil type, climate and agro-eco-region. Some common legumes that can be grown as cover crops and the quantity of N fixed by these crops are listed in Table 17.3.

17.5.8 Use of Biofertilizers

Biofertilizers have been recognized as important inputs in integrated plant nutrition systems. The use of legume green manure, blue green algae and Azolla for rice; Azotobacter and Azospirillum for wheat, millets and vegetable crops; Rhizobium for pulses and oil legume crops, Phosphate solubilizers Vesicular Arbuscular Mycorrhizae) for various crops is well reported, on an average these biofertilizers can minimize the use of inorganic N by 25–50 kg/ha.

17.5.9 Green Manuring

The green manure crops when applied improve the physical and chemical properties of the soil. Green manures also increase the fertilizer use efficiency of crops when applied in combination with inorganic fertilizers. Among the green manure crops, special attention is being given to *Sesbania rostrata*, which bears stem nodules in addition to the root nodules. The amount of N contributed in terms of fertilizer N equivalence ranges from 80–120 kg/ha. In a field trial comprising different green manure crops, it was found out that *Sesbania rostrata* produced the highest biomass (20–25 tons/ha) and accumulated a maximum of 150–220 kg N/ha. More details are given in the chapter 15. The common leguminous green manure crops used in tropics and their N content are given in Table 17.4.

Table 17.4. Common Green Manure Crops and their N content

<i>Crop species</i>	<i>Scientific name</i>	<i>Biomass</i>	<i>N per cent (Moist)</i>
Sunnhemp	<i>Crotalaria juncea</i>	21.2	0.43
Dhaincha	<i>Sesbania aculeata</i>	20.0	0.43
Dhaincha	<i>Sesbania rostrata</i>	19.6	–
Pillipesara	<i>Phaseolus trilobus</i>	18.3	1.10
Mungbean	<i>Phaseolus arvensis</i>	8.0	0.53
Cowpea	<i>Vigna sinensis</i>	15.0	0.49
Guar	<i>Cyamopsis tetragonoloba</i>	20.0	0.34
Senji	<i>Melilotus alba</i>	28.6	0.57
Khesari	<i>Lathyrus sativus</i>	12.3	0.54

Annexures

ANNEXURE-1

Units related to Crop Production

A. AREA

Inch: It is equal to 2.54 cm.

Foot: It is equal to 30.48 cm or 0.305 m.

Cent: It is a unit of measurement of an area of land, which is 1/100 of an acre. This is equal to 40 m² or 435.6 sq. ft.

Area: A unit of measurement of an area to 100 cents (4000 m²). It is also equal to 2/5th of hectare.

Hectare: It refers to an area of 10,000 m² or 250 cents or 2.5 acres.

100 kuzhi = 1 maa or kaani; 3 maa = 1 acre; 20 maa = 6.67 acres = 1 veli.

B. WEIGHT

Pound : It is a unit of weight equal to 454 grams.

Kilogram : It is unit of weight equal to 1000 grams or 2.203 pounds.

Quintal : This refers to a unit of weight equal to 100 kg or 0.1 tonne.

Bale : 177.8 kg (cotton lint).

Tonne : Unit of weight equal to 1000 kg or 10 quintals.

Million tonnes : 10,00,000 tonnes.

C. VOLUME

Milli litre (ml) : It is a unit of volume equal to 1/1000th of a litre. 1 ml = 1 cc = 1cu. mm.

Litre : It is a volume equal to 1000 ml or 1000 cc.

Cubic meter : It is a volume equal to 1000 litres.

Cubic foot : It is a volume equal to 28.32 litres.

TMC : Thousand metric cubic feet.

Imp. gallon : 4.546 litres.

ANNEXURE-1A

Conversion Factors between Important Primary and Secondary Agricultural Commodities

<i>Commodity</i>	<i>Conversion Factor</i>
Rice (Cleaned) Production	2/3 of Paddy Production
Cotton	
Cotton Lint Production	1/3 of Kapas Production
Cotton Seed Production	2/3 of Kapas Production
	2 Times of Cotton Lint Production
Jute	
100 Yards of Hessian	54 lbs. of Raw Jute
4148 Yards of Hessian	1 Ton of Raw Jute
	(5.55 Bales of Raw Jute (of 180 Kgs. Each)
1 Ton of Sacking	1.11 Tons of Raw Jute
	6.17 Bales of Raw Jute (of 180 Kgs. Each)
1 Ton of Hessian	1.05 Tons of Raw Jute
Sacking etc.	5.85 Bales of Raw Jute (of 180 Kgs. Each)
Groundnut	
Kernel to Nuts in Shell	70 Percent
Oil to Nuts in Shell	28 Percent
Oil to Kernels Crushed	40 Percent
Cake to Kernels Crushed	60 Percent
Sesamum	
Oil to Seeds Crushed	40 Percent
Cake to Seeds Crushed	60 Percent
Rape seed and Mustard	
Oil to Seeds Crushed	33 Percent
Cake to Seeds Crushed	67 Percent
Linseed	
Oil to seeds Crushed	33 Percent
Cake to Seeds Crushed	67 Percent
Castor seed	
Oil to Seeds Crushed	37 Percent
Cake to Seeds Crushed	63 Percent
Cotton Seed	
Oil to Seeds Crushed	14–18 Percent
Cake to Seeds Crushed	82–86 Percent
Coconut	
Copra to Nuts	One Ton of Copra = 6773 Nuts

Oil to Copra Crushed	62 Percent
Cake to Copra Crushed	38 Percent
Niger seed	
Oil to Seeds Crushed	28 Percent
Cake to Seeds Crushed	72 Percent
Kardi Seed	
Oil to Seeds Crushed	40 Percent
Cake to Seeds Crushed	60 Percent
Mahua Seed	
Oil to Seeds Crushed	36 Percent
Cake to Seeds Crushed	64 Percent
Neem Seed	
Oil to Kernels Crushed	45–50 Percent
Cake to Kernels Crushed	50–55 Percent
Soyabean Seed	
Oil to Soyabean Seed Crushed	18 Percent
Meal to Soyabean Seed Crushed	73 Percent
Hull from Soyabean Seed Crushed	8 Percent
Wastage from Soyabean Seed Crushed	1 Percent
Sugar	
Gur from Cane Crushed	11.20 Percent to 11.50 Percent
Crystal Sugar from Gur Refined (Gur Refineries)	62.5 Percent
Crystal Sugar from Cane Crushed (Cane Factories)	10.20 Percent
Khandasari Sugar (Sulphur and Non-sulphur) from standard Gur Refined	46 Percent
Molasses from Cane Crushed	4.0 Percent to 4.5 Percent
Cane–Trash* from Cane Harvested	8.0 Percent to 12.0 Percent
Lac	
Seed Lac	66.0 Percent of Stick Lac
Shell Lac	57.4 Percent of Stick, or 87.0 Percent of Seed Lac
Cashew nut	
Cashew Kernel	25 Percent of Cashew nuts

* This consists of leaves and portion of the top of stalk which are removed from the cane stalk, while harvesting and before sending the cane for milling.

ANNEXURE-2

List of Crops—Common and Botanical Names

Cereals and millets		
1. Rice	-	<i>Oryza sativa</i> Linn.
2. Wheat	-	<i>Triticum aestivum</i> L. <i>Triticum sativum</i> , Lamk.
3. Maize	-	<i>Zea mays</i> Linn.
4. Rye	-	<i>Secale cereale</i> Linn.
5. Oat	-	<i>Avena sativa</i> Linn.
6. Barley	-	<i>Hordeum vulgare</i> Linn.
7. Sorghum, Jowar	-	<i>Sorghum bicolor</i> Pers.
8. Pearl millet, Bajra	-	<i>Pennisetum glaucum</i> Linn.
9. Finger millet, Ragi	-	<i>Eleusine coracana</i> Gaertn.
10. Barnyard millet (kuthiraivali)	-	<i>Echinochloa frumentacea</i> Roxb.
11. Italian millet (thenai)	-	<i>Setaria italica</i> . Linn.
12. Kodo millet (varagu)	-	<i>Paspalum scrobiculatum</i> . Linn.
13. Common millet (panivaragu)	-	<i>Panicum millaceum</i> Linn.
14. Little millet (samai)	-	<i>Panicum milleare</i> Linn.
Pulses		
1. Black gram, Kalai, Urd	-	<i>Vigna mungo</i> var, <i>radiatus</i> Linn.
2. Chickling vetch, khesari	-	<i>Lathyrus sativus</i> Linn.
3. Chickpea, Gram	-	<i>Cicer arietinum</i> Linn.
4. Cowpea	-	<i>Vigna sinensis</i> Savi
5. Green gram Mung or Moong	-	<i>Vigna radiatus</i> Roxb.
6. Horse gram, kulthi	-	<i>Macrotyloma uniflorum</i> Linn.
7. Lentil	-	<i>Lens esculenta</i> Moench
8. Moth bean	-	<i>Phaseolus aconitifolia</i> Linn.
9. Peas	-	<i>Pisum sativum</i> Linn.
10. Pigeon pea, Arhar, Tur	-	<i>Cajanas cajan</i> Millsp. (<i>Cajanus indicus</i>)
11. Pillipesara	-	<i>Phaseolus trilobus</i> .
12. Soybean	-	<i>Glycine max.</i> Linn. Merr.
Oilseeds		
1. Black mustard	-	<i>Brassica nigra</i> Linn. Koch.
2. Castor	-	<i>Ricinus communis</i> Linn.
3. Coconut	-	<i>Cocus nucifera</i> Linn.
4. Groundnut/peanut	-	<i>Arachis hypogaea</i> Linn.
5. Indian mustard or rai	-	<i>Brassica Cass</i> Linn.
6. Indian rape or toria	-	<i>Brassica napeustris</i> Linn., var, napus

7. Niger	-	<i>Guizotia abyssinica</i> Cass
8. Linseed	-	<i>Linum usitatissimum</i> Linn.
9. Safflower	-	<i>Carthamus tinctorious</i> Linn.
10. Sesame/Gingelly/Til	-	<i>Sesamum indicum</i> Linn.
11. Sunflower	-	<i>Helianthus annus</i> Linn.
12. White mustard	-	<i>Brassica alba</i> Linn.
13. Oil palm	-	<i>Elaeis guinensis</i> .
<hr/>		
Fibre Crops		
<hr/>		
1. Cotton	-	<i>Gossypium</i> spp.
2. Jute	-	<i>Corchorus</i> spp.
3. Mesta	-	<i>Hibiscus cannabinus</i> Linn.
4. Sunnhemp	-	<i>Crotalaria juncea</i> Linn.
<hr/>		
Fumitories, Masticatorias		
<hr/>		
1. Tobacco (Desi)	-	<i>Nicotiana tobacum</i> .
2. Tobacco (Calcutta)	-	<i>Nicotiana rustica</i> .
<hr/>		
Sugars and Starches		
<hr/>		
1. Pine apple	-	<i>Ananas sativa</i> Schutt.
2. Potato	-	<i>Solanum tuberosum</i> Linn.
3. Sugar beet	-	<i>Beta vulgaris</i> Linn.
4. Sugarcane	-	<i>Saccharum officinarum</i> Linn.
5. Sweet potato	-	<i>Ipomea batatus</i> Lann.
6. Tapioca	-	<i>Manihot esculenta crantz</i> .
<hr/>		
Spices and Condiments		
<hr/>		
1. Black pepper	-	<i>Piper nigrum</i> L.
2. Betel vine	-	<i>Piper betle</i> L.
3. Cardamom	-	<i>Elettaria cardamomum</i> Matora.
4. Coriander	-	<i>Coriandrum sativum</i> Linn.
5. Garlic	-	<i>Allium sativum</i> Linn.
6. Ginger	-	<i>Zingiber officinale</i> Rose
7. Onion	-	<i>Allium cepa</i> Linn.
8. Red pepper, Chillies	-	<i>Capsicum annum</i> Linn.
9. Turmeric	-	<i>Curcuma longa</i> Linn.
<hr/>		
Forage Grasses		
<hr/>		
1. Buffel grass, Anjan	-	<i>Cenchrus ciliaris</i> .
2. Dallis grass	-	<i>Paspalum dilatatum</i> Poir.

3. Dinanath grass	-	<i>Pennisetum.</i>
4. Guinea grass	-	<i>Panicum maximum</i> Jacq.
5. Marvel grass	-	<i>Dicanthium annulatum</i> (Forsk.)
6. Napier or Elephant grass	-	<i>Pennisetum purpureum</i> Schum.
7. Pangola grass	-	<i>Digitaria decumbens</i> Stent.
8. Para grass	-	<i>Brachiaria mutica.</i>
9. Sudan grass	-	<i>Sorghum sudanense</i> Stapf.
10. Teosinte	-	<i>Euchlaena mexicana</i> Schrad.
11. Blue panicum	-	<i>Panicum antidotale</i> Retz.
Forage Legumes		
1. Berseem/Egyptian Clover	-	<i>Trifolium alexandrinum</i> Linn.
2. Centrosema	-	<i>Centrosema pubescens.</i>
3. Gaur/Cluster bean	-	<i>Cyamopsis tetragonoloba</i> Taub.
4. Lucerne/Alfalfa	-	<i>Medicago sativa</i> Linn.
5. Sirato	-	<i>Macroptilium atropurpureum.</i>
6. Velvet Bean	-	<i>Mucuna cochinchinensis</i> Brot.
Plantation Crops		
1. Banana	-	<i>Musa paradisiaca</i> L.
2. Areca Palm	-	<i>Areca catechu</i> Linn.
3. Arrowroot	-	<i>Maranta arundinacea</i> L.
4. Cacao	-	<i>Theobroma cacao</i> Linn.
5. Coconut	-	<i>Cocos nucifera</i> Linn.
6. Coffee	-	<i>Coffea arabica</i> Linn.
7. Tea	-	<i>Camellia theasinesis</i> O. Ktze.
Green Manure Crops		
1. Daincha	-	<i>Sesbania aculeata</i> Poir.
	-	<i>Sesbania speciosa</i> Tam.
2. Sunnhemp	-	<i>Crotolaria juncea</i> Linn. (Sanappai)
3. Manila agathi	-	<i>Sesbania rostrata.</i>
4. Sittagathi	-	<i>Sesbania sesban.</i>
Vegetables		
1. Ash Gourd	-	<i>Beniacasa cerifera</i> Savi.
2. Bitter gourd	-	<i>Momordica charantia</i> Linn.
3. Bottle gourd	-	<i>Lagenaria leucantha</i> Rusby.
4. Brinjal	-	<i>Solanum melongena</i> Linn.
5. Broad bean	-	<i>Vicia faba</i> Linn.

6. Cabbage	-	<i>Brassica oleracea</i> var. capitata Linn.
7. Chinese cabbage	-	<i>B. pekinensis</i> (Lour) Rupr.
8. Carrot	-	<i>Daucus carota</i> Linn.
9. Cauliflower	-	<i>Brassica oleracea</i> var. botrytis Linn.
10. Colocasia	-	<i>Colocasia esculenta</i> (L). Schott.
11. Cucumber	-	<i>Cucumis sativus</i> Linn.
12. Double bean	-	<i>Phaseolus lunatus</i> Linn.
13. Elephant ear/edible arum	-	<i>Colocasia antiquorum</i> Schott.
14. Elephant foot/yam	-	<i>Amorphophallus campanulatus</i> Bhem.
15. French bean	-	<i>Phaseolus vulgaris</i> Linn.
16. Knol khol	-	<i>Brassica oleracea</i> var. Caulorapa Pasq.
17. Lesser yam	-	<i>Dioscorea alata</i> L.
18. Lettuce	-	<i>Lactuca sativa</i> Linn.
19. Must Melon	-	<i>Cucumis melo</i> Linn.
20. Pointed gourd/Parwal	-	<i>Trichosanthes diora</i> Roxb.
21. Pumpkin	-	<i>Cucurbita moschata</i> Dutch.
22. Radish	-	<i>Raphanus sativus</i> Linn.
23. Bhendi	-	<i>Abelmoschus esculentus</i> Linn.
24. Red pumpkin	-	<i>Cucurbita maxima</i> Duch.
25. Ridge gourd	-	<i>Luffa acutangula</i> Roxb.
26. Spinach	-	<i>Spinacia oleracea</i> Linn.
27. Snake gourd	-	<i>Trichosanthes anguina</i> Linn.
28. Tomato	-	<i>Lycopersicum esculentus</i> Mill.
29. Turnip	-	<i>Brassica campestris</i> var. rapa Linn.
30. Watermelon	-	<i>Citrullus vulgaris</i> schrad.
31. Yam	-	<i>Dioscorea esculenta</i> L.

Medicinal Crops

1. Aloe	-	<i>Aloe vera</i> .
2. Ashwagantha	-	<i>Withania somnifera</i> Dunai.
3. Belladonna	-	<i>Atropa belladonna</i> Linn.
4. Bishop's weed	-	<i>Ammi visnaga</i> Linn.
5. Bringaraj	-	<i>Eclipta alba</i> .
6. Cinchona	-	<i>Cinchona</i> sp.
7. Coleus	-	<i>Coleus forskholli</i> Briq.
8. Dioscorea	-	<i>Dioscorea bulbifera</i> Linn.
9. Duboisia	-	<i>Duboisia myoporoides</i> Brown.
10. Glory Lily	-	<i>Gloriosa superba</i> Linn.
11. Ipecae	-	<i>Cephaelis ipecacuanha</i> Linn.
12. Long pepper	-	<i>Piper longum</i> Linn.
13. Opium poppy	-	<i>Papav somniferum</i> .

14. Prim rose	-	<i>Oenothera lamarekiana</i> Linn.
15. Roselle	-	<i>Hibiscus sabdariffa</i> Linn.
16. Sarpagandha	-	<i>Rauvalfia serpentine</i> Benth.
17. Senna	-	<i>Cassia angustifolia</i> Vahl.
18. Sweet Flag	-	<i>Acorus calamus</i> Linn.
19. Valeriana	-	<i>Valeriana wallaichii</i> .

Aromatic Crops

1. Ambrettee	-	<i>Abelmoschus moschatus</i> Medic.
2. Celery	-	<i>Apium graveolens</i> Linn.
3. Citronella	-	<i>Cymbopogon winterianus</i> Jowitt.
4. Geranium	-	<i>Pelargonium graveolens</i> .
5. Jasmine	-	<i>Jasminum grantiflorum</i> .
6. Khus	-	<i>Vetiveria zizanoids</i> .
7. Lavender	-	<i>Lavendula sp.</i> Linn.
8. Lemon grass	-	<i>Cymbopogon flexuosus</i> Stapf.
9. Mint	-	<i>Mint sp.</i>
10. Palmarosa	-	<i>Cymbopogon martini</i> .
11. Patchouli	-	<i>Pogostemon cablin</i> Benth.
12. Sandal wood	-	<i>Santalum album</i> .
13. Sacred Basil (Tulsi)	-	<i>Ocimum sanctum</i> Linn.
14. Tuberose	-	<i>Polianthus tuberosa</i> Linn.

Other Economic Crops

1. Annatto	-	<i>Bixa orellana</i> .
2. Camphor Basil	-	<i>Ocimum kilimandscharicum</i> .
3. Henna	-	<i>Lawsonia inermis</i> Linn.
4. Pyrethrum	-	<i>Chrysanthemum cineraraefolium</i> .

ANNEXURE-3

Efficient Cropping Systems for different Agro-Climatic Zones of India

<i>Agro-climatic region</i>	<i>Soil type</i>	<i>Cropping systems</i>
1. Western Himalayas cold-arid Jammu and Kashmir Ladakh plateau	Shallow, sandy to loamy and skeletal soils	Rice-potato-wheat, Lucerne-oats-vetch
2. Western plain katch and part of Kathiawar peninsula (hot arid regions)	Desert and saline soils	Sorghum-wheat-millet, Maize-Green, manure, Maize-wheat, sorghum-wheat, Cotton-wheat
3. Deccan plateau (hot-arid) Andhra Pradesh, Karnataka	Red and black soils	Pigeon pea + sorghum/groundnut, Cotton-millet-sorghum
4. Northern plains and central highlands (semi-arid) Gujarat, Haryana, Madhya Pradesh, Punjab, Uttar Pradesh, Rajasthan	Alluvium derived soils	Maize-green manure, Rice-wheat, Maize-wheat, cotton-wheat, sorghum-wheat
5. Central highlands Gujarat plains Kathiawar peninsula (hot semi-arid)	Medium deep black soils	Groundnut-wheat, Rice-sugarcane + soybean, Rice-wheat-Green manure, Rice-wheat millet, Pearl millet-potato-cotton
6. Deccan plateau (hot-semi-arid)	Shallow and medium black soils	Cotton-millet-sorghum, Pigeonpea + sorghum/groundnut
7. Deccan plateau and Eastern ghats (hot-semi-arid)	Red and black soils	Sorghum-safflower, Cotton-millet Pigeon pea-sunflower, Groundnut + sorghum-fallow
8. Eastern ghats, Tamil Nadu uplands and Deccan plateau (hot semi-arid)	Red loamy soils	Rice-Rice-pulses, Cotton-groundnut, Groundnut-sorghum, Cotton-millet
9. Northern plain (hot sub humid)	Alluvium derived	Rice-wheat, Maize-wheat, Maize-mustard-sugarcane
10. Central High lands (hot sub-humid)	Black and red soils/	Sorghum-wheat, Maize-wheat Soybean pigeon pea-green gram, Rice-wheat
11. Eastern plateau (hot sub-humid soils)	Red and yellow soils	Rice-wheat-green manure, Rice-pigeon pea, Rice-millet, Pulses-Rice
12. Eastern plateau and Eastern ghats (hot sub-humid)	Red and lateritic soils	Rice-Rice, Rice-wheat, Groundnut-sunflower
13. Eastern plain (hot sub-humid)	Alluvium derived soils	Rice-wheat, Rice-lentil, Rice-chickpea Jute-rice
14. Western Himalayas (warm sub-humid)	Brown, forest and podzolic soils	Rice-wheat, Rice-potato, Maize-wheat finger, millet-rice-mustard small millets-fallow/barley
15. Bengal and Assam plains (hot sub-humid)	Alluvium derived soils	Rice-wheat-rice, rice, Rice-chickpea, Rice-rice, Rice-potato-sesame
16. Eastern Himalayas (warm per humid)	Brown and red hill soils	Rice-rice, rice-wheat, jute-rice Rice/maize-fallow
17. North-eastern Hills (warm per humid)	Red and lateritic soils	Rice-rice-rice-wheat, Jute-rice, Rice/maize-fallow

<i>Agro-climatic region</i>	<i>Soil type</i>	<i>Cropping systems</i>
18. Eastern coastal plains (hot sub-humid to semi-arid)	Coastal alluvium	Rice-rice, Rice-groundnut, Jute-rice, Pulses-fallow, Maize-sorghum-horse gram
19. Western ghats and coastal plains (hot humid per humid)	Red lateritic alluvium derived soils	Rice-fallow/pulses/cassava, Rice-rice, Rice-sorghum, Plantation crops
20. Islands (hot humid to per humid)	Red loamy and sandy soils	Rice-rice, Rice-fallow, Plantation crops

ANNEXURE-4

List of Major Weeds in the World and India

<i>Common name</i>	<i>Scientific name</i>	<i>Growth habitat and kind of plant</i>
Smooth pig weed	<i>Amaranthus hybridus</i>	A-B
Spiny amaranth	<i>Amaranthus spinosus</i>	A-B
Wild oat	<i>Avena fatua</i>	A-G
Common lambsquarters	<i>Chenopodium album</i>	A-B
Field bind weed	<i>Convolvulus arvensis</i>	P-B
Bermuda grass	<i>Cynodon dactylon</i>	P-G
Yellow nut sedge	<i>Cyperus esculentus</i>	P-S
Purple nut sedge	<i>Cyperus rotundus</i>	P-S
Crab grass	<i>Digitaria sanguinalis</i>	A-G
Jungle rice	<i>Echinochloa colonum</i>	A-G
Barnyard grass	<i>Echinochloa crusgalli</i>	A-G
Water hyacinth	<i>Eichhornia crassipes</i>	P-B
Goose grass	<i>Eleusine indica</i>	A-G
Cogon grass	<i>Imperata cylindrical</i>	P-G
Sour paspalum	<i>Paspalum conjugatum</i>	P-G
Common purslane	<i>Portulaca oleracea</i>	A-B
Itch grass	<i>Rottboellia exaltata</i>	A-G
Johnson grass	<i>Sorghum halepense</i>	P-G

A-annual; B-biannual; P-Perennial;

G-grasses; S-sedges; B-Broad leaf weeds.

ANNEXURE-5

Most Common Weeds in Crop Fields of India

<i>Monocot species</i>	<i>Dicot species</i>
ANNUALS	
<i>Barnyard grass (Echinochloa crusgalli)</i>	<i>Goat weed (Ageratum conyzoids)</i>
<i>Crabgrass (Digitaria sp.)</i>	<i>Pig weed (Amaranthus sp.)</i>
<i>Foxtail (Setaria sp.)</i>	<i>Black jack (Bidens pilosa)</i>
<i>Sandbur (Cenchrus sp.)</i>	<i>Cox comb (Celosia argentia)</i>
<i>Wild oat (Avena fatua)</i>	<i>Lambsquarters (Chenopodium album)</i>
<i>Goose grass (Eleusine indica)</i>	<i>Wild carrot weed (Parthenium hysterophorus)</i>
<i>Torpedo grass (Panicum repens)</i>	<i>Common purslane (Portulaca oleracea)</i>
<i>Canary grass (Philaris minor)</i>	<i>Horse purslane (Trianthema portulacastrum)</i>
<i>Crowfoot grass (Dactyloctenium aegyptium)</i>	
PERENNIALS	
<i>Bermuda grass (Cynodon dactylon)</i>	<i>Canada thistle (Cirsium arvense)</i>
<i>Thatch grass (Imperata cylindrical)</i>	<i>Day flower (Commelina benghalensis)</i>
<i>Johnson grass (Sorghum halepense)</i>	<i>Field bind weed (Convolvulus arvensis)</i>
<i>Quack grass (Agropyron repens)</i>	<i>White horse nettle (Solanum elaeagnifolium)</i>
<i>Nut grass (Cyperus rotundus)</i>	

ANNEXURE-6**Contribution of Agriculture to National Income**

<i>Year</i>	<i>Percentage contribution of agriculture and allied activities to National income</i>
1950–1951	56.1
1960–1961	51.2
1970–1971	50.6
1980–1981	42.0
1984–1985	36.9
1989–1990	30.0
1999–2000	25.5

ANNEXURE-7**National Institutions for Agricultural Research**

1. Central Arid Zone Research Institute (CAZRI), Jodhpur-342 003, Rajasthan.
2. Central Institute for Cotton Research (CICR), Panjari farm, Wardha Road, Nagpur-440 010, Maharashtra.
3. Central Institute of Agricultural Engineering (CIAE), Nabi-Bagh, Berasia Road, Bhopal-462 038, Madhya Pradesh.
4. Central Institute of Brackish water Aquaculture (CIBA) 141, Marshalls Road, Egmore, Chennai-600 008, Tamil Nadu.
5. Central Institute of Fisheries Technology (CIFT), Willington Island, Cochin-628 029, Kerala.
6. Central Marine Fisheries Research Institute (CMFRI), P.B. No. 1603, Ernakulam, Cochin-682 014, Kerala.
7. Central Plantation Crops Research Institute (CPCRI), P.O. Kudlu, KasarKod-671 124, Kerala.
8. Central Potato Research Institute (CPRI) Simla-171 001, Himachal Pradesh.
9. Central Research Institute for Dry land Agriculture, (CRIDA), Santhosh Nagar, Hyderabad-500 659, Andhra Pradesh.
10. Central Research Institute for Jute and Allied Fibres (CRIJAF) Nilganj, District 24, Parganas (North) P.O. Barrackpore-743 101, West Bengal.
11. Central Rice Research Institute (CRRI), Cuttack-753 006, Orissa.
12. Central Sheep and Wool Research Institute (CSWRI), Avika Nagar, Malpura-304 501, Rajasthan.
13. Central Soil and Water Conservation Research and Training Institute. (CSWCRTI), 218, Kaulagarh Road, Dehradun-248 195, Uttar Pradesh.
14. Central Soil Salinity Research Institute (CSSRI), Zarifa farm, Kachhwa Road, Karnal-132 001, Haryana.
15. Central Tobacco Research Institute (CTRI), Rajamundry-533 105, Andhra Pradesh.
16. Central Tuber Crops Research Institute (CTCRI), Sree Kariyam, Thiruvananthapuram-695 017, Kerala.
17. Indian Agricultural Research Institute (IARI), New Delhi-110 012.
18. Indian Agricultural Statistics Research Institute (IASRI) Library Avenue, Pusa, New Delhi-110 012.
19. India Grassland and Fodder Research Institute (IGFRI) Gwalior–Jhansi Road, Jhansi-284 003, Uttar Pradesh.
20. Indian Institute of Horticultural Research (IIHR), Hassaraghatta, Lake post, Bangalore-560 089, Karnataka.
21. Indian Institute of Pulses Research (IIPR) Kalyanpur, Kanpur-208 024, Uttar Pradesh.
22. Indian Institute of Soil Science (IISS) Z-6, Zone–1, Maharana Pratap Nagar, Bhopal, 462 001, Madhya Pradesh.
23. Indian Institute of Spices Research (IISR), P.B. No. 1701, Marikunnu. P.O., Calicut-673 012, Uttar Pradesh.
24. Indian Institute of Sugarcane Research (IISR), Rae Bareli Road, P.O. Dilkusha, Lucknow, Uttar Pradesh–226 002.

25. Indian Lac Research Institute (ILRI), P.O. Namkum, Ranchi-843 010, Bihar.
26. Indian Veterinary Research Institute, (IVRI) Izat Nagar-243 122, Uttar Pradesh.
27. Jute Technological Research Laboratories (JTRL) 12, Regent Park, Calcutta-700010, West Bengal.
28. National Bureau of Plant Genetic Resources (NBPGR), IARI Pusa Campus, New Delhi-110 012.
29. National Bureau of Soil Survey and Land Use Planning, (NBSS and LUP) Amaravathi Road, Nagpur, 440 010, Maharashtra.
30. National Dairy Research Institute (NDRI), Karnal-132 001, Haryana.
31. National Research Centre for Agroforestry (NRCAF), IGFR Campus, Jhansi-284 003, Uttar Pradesh.
32. National Research Centre for Banana (NRCB), 44, Ramalinga Nagar, Vayalur Road, Tiruchirappalli-620 017, Tamil Nadu.
33. National Research Centre for Oil Palm (NRCOP), Ashok Nagar, Eluru, Pedavagai, West Godavari District-534 002, Andhra Pradesh.
34. National Research Centre for Weed Science (NRCWS) 215, Ravindra Nagar, Adhartal, Jabalpur-482 004, Madhya Pradesh.
35. Sugarcane Breeding Institute, (SBI) Coimbatore-641 007, Tamil Nadu.

ANNEXURE-8**International Institutions for Agricultural Research**

1. Centro Internacional de Agricultura Tropical (CIAT) Apartado Aereo 6713, Cali, Columbia.
2. Central International de la Papa (CIP) (International Institute of Potato) Apartado postal 5969, Lima, Peru.
3. Centro Internacional de Mejoramiento de Maiz y Trigo (CIMMYT) (International Centre for maize and Wheat Improvement) Londres 40, Apartado Postal 6-641, 06600 Mexico, D.F. Mexico.
4. International Centre for Agricultural Research in the Dry Areas (ICARDA) P.O. Box-5466, Aleppo, Syria.
5. International Crops Research Institute for the Semi Arid Tropics (ICRISAT), Patancheru, Hyderabad, P.O., 502 324, Andhra Pradesh, India.
6. International Food Policy Research Institute (IFPRI), 1776, Massachusetts Avenue, N.W., Washington, D.C. 20036, U.S.A.
7. International Institute of Tropical Agriculture (IITA) P.O. Box, 5320, Ibadan, Nigeria.
8. International Laboratory for Research in Animal Diseases (ILRAD), P.O. Box 30709, Nairobi, Kenya.
9. International Service in National Agricultural Research (ISNAR) P.O. Box 93375, 2509, A.J. The Hague, Netherlands.
10. International Livestock Centre in Africa (ILCA), P.O. Box. 5689. Addis Ababa, Ethiopia.
11. West Africa Rice Development Association (WARDA) Ivory coast, Liberia.
12. International Rice Research Institute (IRRI), P.O. Box 933, Manila, Philippines.
13. Natural Resources Institute (NRI), Central Avenue, Chatham Maritime, Kent MC. U.K.
14. Asian Vegetable Research and Development Centre (AVRDC) P.O. Box 42, Shanhai, Tasnan 941, Taiwan, Republic of China.
15. International Centre of Insect Physiology and Ecology (ICIPE) P.O. Box 30772, Nairobi, Kenya.
16. International Council for Research in Agro Forestry (ICRAF) P.O. Box 30677, Nairobi, Kenya.
17. International Irrigation Management Institute (IIMI), Colombo, Sri Lanka.
18. Consultative Group on International Agricultural Research (CGIAR), 1818, Hst., N.W. Washington. D.C.U.S.A.
19. Winrock International Institute for Agricultural Development (WINROCK INTERNATIONAL), Canada.

ANNEXURE-9

Selected Indicators of Agriculture Development in India, Asia-Pacific Region and the World, 1994 and 2003

Sl. No.	Indicator	Year	India	Asia-Pacific Region			World
				Developing countries	Developed countries	Total	
1.	Agriculture Land ('000 hectares)**	1994	169790	505220	60254	565474	1528915
		2003	169739	519203	56043	575346	1540572
2.	Agriculture Land as % of Total Land	1994	57.1	19.2	7.2	16.3	11.8
		2003	57.1	19.7	6.7	16.6	11.8
3.	Agriculture Population ('000)	1994	515982	1848819	8162	1.9E+06	2506964
		2004	559656	1920090	5073	1.9E+06	2600301
4.	Agriculture Population as % of Total Population	1994	56.4	59.9	5.6	57.4	44.8
		2004	51.8	54.3	3.3	52.2	40.8
5.	Ratio of Agriculture Land to Agriculture Population (Hectare/Person)	1994	0.33	0.27	7.38	0.30	0.61
		2004*	0.30	0.27	11.05	0.30	0.59
6.	Irrigated Land as % of Agricultural Land	1994	27.9	32.1	9.1	29.7	17.0
		2003	31.3	33.9	9.7	31.6	18.0
7.	Consumption Per hectare of Agriculture Land (Kg. Plant nutrient/hectare)	1993	73.0	101.2	71.9	90.3	79.5
		2002	94.8	139.8	77.8	122.7	91.9
8.	No. of Agricultural Tractors in Use	1994	1257630	3482991	2451000	5.9E+06	26129160
		2003	2528122	5273631	2419000	7.7E+06	27625100

* Assumes same agricultural land area for 2004 as for 2003; data for Marshall Islands, FSM and Palau not reported in 1994.

** "Agricultural Land" as used in this publication refers to "Arable and Permanent Cropped Land", which excludes permanent meadows and pastures, fallow land resulting from shifting cultivation, and land under trees grown for food or timber. Double cropped.

Source: Selected Indicators of Food and Agriculture Development in Asia-Pacific Region. FAO Regional Office for Asia and the Pacific, Bangkok.

ANNEXURE-10

India's Position in World Agriculture in 2003

Item	India	World	India's position		
			% Share	Rank	Next to
1. Area ** (Million Hectares)					
Total Area	329	13428	2.4	Seventh	Russian Federation, Canada, U.S.A., China, Brazil, Australia
Land Area	297	13067	2.3	Seventh	Russian Federation, China, Canada, U.S.A., Brazil, Australia
Arable Land	162 F	1404	11.5	Second	U.S.A.
Irrigated Area	55 F	277	20.6	First	
2. Population (Million)					
Total	1050	6225	16.9	Second	China
Agriculture	755	3234	23.3	Second	China
3. Economically Active Population (Million)					
Total	460	3037	15.1	Second	China
Agriculture	270	1333	20.3	Second	China
4. Crop Production (Million Tonnes)					
(A): Total Cereals					
Wheat	65	556	11.7	Second	China
Rice (Paddy)	132	589	22.4	Second	China
Coarse grains	35	930	3.8	Forth	U.S.A., China, Brazil
Total Pulses	12	57	21.1	First	
(B): Oilseeds					
Groundnut (in shell)	8*	36	22.2	Second	China
Rapeseed and Mustard	4	36	11.1	Third	China, Canada
5. Fruits and Vegetables (Million Tonnes)					
(A) : Vegetables and Melons	82 F	842	9.7	Second	China
(B) : Fruits excluding Melons	46	480	9.6	Second	China
(C) : Potatoes	23	311	7.4	Third	China, Russian Federation
(D) : Onion (Dry)	5 F	53	9.4	Second	China
6. Commercial Crops (Million Tonnes)					
(A) : Sugarcane	290	1333	21.8	Second	Brazil
(B) : Tea	0.89	3.21	27.7	First	
(C) : Coffee (green)	0.28	7.20	3.9	Sixth	Brazil, Vietnam, Indonesia, Colombia, Mexico
(D) : Jute and Jute like Fibres	1.98	3.23	61.3	First	

(Contd.)

<i>Item</i>	<i>India</i>	<i>World</i>	<i>India's position</i>		
			<i>% Share</i>	<i>Rank</i>	<i>Next to</i>
(E) : Cotton(lint)	2.10	19.53	18.8	Third	China, U.S.A.
(F) : Tobacco Leaves	0.60	6.2	9.7	Third	China, Brazil
7. Livestock (Million Heads)					
(A) : Cattle	226 *	1371	16.5	First	
(B) : Buffaloes	97 *	171	56.7	First	
(C) : Camels	0.90 F	19.07	4.7	Fourth	Somalia, Sudan, Mauritania
(D) : Sheep	59 F	1024	5.8	Third	China, Australia
(E) : Goats	124 F	768	16.1	Second	China
(F) : Chicken	824 F	16605	5.0	Fifth	China, U.S.A., Indonesia, Brazil
8. Animal Products					
(A) : Total Milk (000 MT)	86960 *	599600	14.5	First	
(B) : Eggs Total (Million)	2200 F	60469	3.6	Fourth	China, U.S.A., Japan,
(C) : Total Meat (000 MT)	6038 F	253528	2.4	Sixth	China, U.S.A., Brazil, Germany, France
9. Implements (Thousands numbers)**					
Tractors-in-use	1525 F	26704	5.7	Fourth	U.S.A., Japan, Italy

F : FAO Estimates

* Unofficial Figures

** Figures relate to 2002

Source: FAO Production Year Book, 2003

APPENDIX-11

Production and Productivity in Agriculture during past 50 years
Area: million ha., Production: t., Yield: kg./ha

Crop		1950-51	1960-61	1970-71	1980-81	1990-91	1995-96	1996-97	1997-98	1998-99	1999-00	2000-01
All food grains	Area	97.30	115.60	124.30	126.70	127.80	121.02	123.58	123.88	125.17	123.06	119.01
	Production	50.82	82.02	108.42	129.59	176.39	180.42	199.44	192.26	203.61	208.87	196.07
	Yield	522	710	872	1023	1380	1491	1614	1552	1627	1677	1638
Rice	Production	20.58	34.58	42.22	53.63	74.29	76.98	81.74	82.53	86.05	89.55	86.30
	Yield	668	1013	1123	1336	1740	1797	1882	1900	1921	1990	1927
Wheat	Production	6.46	11.00	23.83	36.31	55.14	62.10	69.35	86.33	71.23	75.52	68.46
	Yield	663	851	1307	1630	2281	2483	2679	2485	2590	2756	2742
Oilseeds	Production	5.16	6.98	9.63	9.37	18.61	22.11	24.38	21.32	24.75	20.87	18.20
	Yield	481	507	579	532	771	851	926	816	944	856	790
Sugarcane	Production	57.02	110.00	126.37	154.25	241.05	281.10	277.56	279.54	285.72	299.23	300.32
	Yield	33422	45548	48322	57844	65395	67787	66496	71134	79203	70805	69550
Pulses	Production	8.40	12.70	11.82	10.63	14.26	12.31	14.24	12.98	14.91	13.35	11.06
	Yield	441	539	524	473	578	552	635	567	634	630	553
Coarse cereals	Production	15.38	23.74	30.55	29.0 2	32.70	29.03	34.10	30.40	31.34	30.60	30.25
	Yield	408	528	665	695	900	940	1072	986	1068	1034	1000
Milk	Production	17.00	20.00	-	31.60	53.90	66.20	69.10	70.80	74.70@	78.1	81.00
Fish	Production	0.75	1.16	-	2.44	3.84	4.95	5.35	5.39	5.26	5.66	-
Irrigated area	22.56	27.98	38.19	49.78	62.47	71.35	73.25	72.78	-	-	-	
Fertilizer consumption (t)	0.07	0.29	2.17	5.52	12.55	13.88	14.31	16.19	16.80	18.07	-	
Per capita availability of food grains (gms/day)	394.90	449.60	455.01	410.40	472.60	495.30	476.20	505.50	450.30	470.40	458.60	

Note: @ Anticipated

Source: *Agricultural Statistics at a Glance, 2001*, Directorate of Economics and Statistics, Ministry of Agriculture, Government of India.

ANNEXURE- 12

Tamil Nadu Basic Statistics

Tamil Nadu State is situated at the South-eastern extremity of the Indian peninsula bounded on the north by Karnataka and Andhra Pradesh, in the East by Bay of Bengal, in the South by Indian Ocean and in the West by Kerala State. It has a coastal line of 922 km and a land boundary of 1200 km. It lies between 8°5' and 13°35' at N latitude and 76°15' and 80°20' of E longitude with an area of 1,30,069 sq. km. (50,154.7 sq. miles).

PHYSICAL FEATURES

The State can be divided broadly into two natural divisions *i.e.*, (a) the coastal plains, and (b) the hilly western areas. It can further be divided into coromandal plains comprising of the districts of Kancheepuram, Tiruvellore, Cuddalore, Villupuram, and Vellore, Thiruvannamalai and alluvial plains of Cauvery delta extending over Thanjavur, Nagapattinam, Thiruvarur and part of Trichy and dry southern plains in Madurai, Ramanathapuram, Sivaganga, Virudunagar, Tuticorin and Tirunelveli districts. It also extends a little in Western Ghats in Kanyakumari District. The Western Ghats averaging 3000' to 8000' height runs along the western part with the hill groups of Nilgiris and Anamalais on either side of it. Palani hills, Varashanad and Andipatti ranges are the major off-shoots of Ghats. The other prominent hills comprise of Javadis, Shervarayan, Kalvarayans and Pachai Malais. These ranges continue south of river Cauvery. A plateau is found between these hills and the Western Ghats with an average elevation of 1000 feet raising west-ward. The highest peak of Doddapettah in the Nilgiris is 8650' above M.S.L. Western Ghats forms a complete watershed and no river passes through them. The main streams *i.e.*, Paraliyar, Vattasery Phazhayar etc. are of limited length and fall in the Arabian sea. All other rivers are east-flowing rivers. The Eastern Ghats are not a complete watershed and as a result the rivers pass through them at places, notable among them is the river Cauvery. The main rivers of Tamil Nadu are Cauvery (with tributaries of Bhavani, Amaravathi, Noyyal) Vaigai, Tamaraparani, Palar, Ponnaiyar and Vellar.

CLIMATE

The climate of Tamil Nadu is basically tropical. Due to its proximity to the sea, the summer is less hot and winter is less cold. The maximum daily temperature rarely exceeds 43°C and the minimum daily temperature seldom falls below 18°C. The State is exposed to both South-west and North-east Monsoons.

AGRO-CLIMATIC ZONES

Based on rainfall distribution, irrigation pattern, soil characteristics, cropping pattern and other physical ecological and social characteristics, Tamil Nadu State is classified into seven districts agro-climatic zones delineated as follows:

- (i) *Northeastern Zone*: This zone covers the districts of Kancheepuram, Tiruvellore, Vellore, Thiruvannamalai, Cuddalore (excluding Chidambaram and Kattumannarkovil taluks) and Ariyalur and Perambalur taluks in Perambalur district.
- (ii) *Northwestern Zone*: This zone comprises Dharmapuri district (Excluding hilly areas), Salem and Namakkal districts (Excluding Tiruchengode taluk) and Perambalur taluk of Perambalur district.
- (iii) *Western Zone*: Comprising Erode and Coimbatore districts, Tiruchengode taluk of Namakkal, Karur Taluk of Karur district and northern parts of Madurai district.

- (iv) *Cauvery Delta Zone*: This zone covers the Cauvery Delta area in Thanjavur, Nagapattinam, Thiruvarur districts and Musiri, Tiruchirappalli, Lalgudi, Thuraiyur and Kulithalai taluks of Tiruchirappalli districts, Aranthangi taluk of Pudukottai and Chidambaram and Kattumannarkoil taluks of Cuddalore District.
- (v) *Southern Zone*: This zone includes Ramanathapuram, Virudunagar, Sivaganga, Tuticorin and Tirunelveli districts, Dindigul and Natham taluks of Dindigul district, Melur, Tirumangalam, Madurai South and Madurai North taluks of Madurai district and Pudukottai district (excluding Aranthangi taluk).
- (vi) *High Rainfall zone*: This zone consists of Kanyakumari district.
- (vii) *Hilly zone*: This zone covers the hilly regions, the Nilgiris, Shevroys, Elagiri-Javadhi, Kollimalai, Pachaimalai, Anamalais, Palanis and Podhigai malai.

RAINFALL

The Western ghats acting as a barrier deprive the State of the full blast of South-west monsoon winds. However, South-west Monsoon has a precipitation of about 1/3rd of the normal rainfall received in Tamil Nadu which helps in taking up the rainfed cultivation. The State depends mainly on the North-east Monsoon rains which are brought by the troughs of low pressure establishing in south Bay of Bengal between October and December. The following are the normal rainfall during the major season of State.

<i>Season</i>	<i>Normal rainfall (In mm)</i>
South-west Monsoon	307.6
North-east Monsoon	438.7
Winter	42.2
Summer	136.5
Total	925.0

High Rainfall Regions: The Nilgiris, the coastal belt of the Cuddalore, Kancheepuram districts and Palani hills.

Medium Rainfall Regions: Western parts of the Cuddalore, Tiruvellore districts, whole of Vellore, Thiru-vannamalai, eastern parts of the Salem, Western part of Thanjavur, Nagapattinam, eastern and northern parts of Trichy, eastern part of Madurai, Dindigul, northern part of Ramanathapuram, Sivaganga, Virudunagar, Coimbatore and Salem.

Low Rainfall Regions: Central and Southern parts of Ramanathapuram, Sivaganga, Virudunagar, Tuticorin and Tirunelveli districts and Central part of Coimbatore, Central and Western parts of Madurai Dindigul and the Southern half of Tiruchirappalli.

Number of Rainy Days: State average is 50 days per year and the highest is 106.2 in Nilgiris and the lowest is 45.8 in Ramanathapuram.

SOILS

The predominant soils of Tamil Nadu are red loam and laterite black, alluvial and saline soils.

Red Loam: This soil occupies a large part of the State particularly interior districts including the coastal districts. It is found predominantly in Kancheepuram, Cuddalore, Vellore, Salem, Dharmapuri,

Ramanathapuram, Coimbatore, Trichy, Pudukkottai, Thanjavur, Sivaganga, Virudunagar, Madurai, Dindigul, Nagapattinam, Tuticorin, Tirunelveli and the Nilgiris. The red or brown colour of the soil is attributed to the diffusion of iron content.

Laterite Soil: This soil is clayey and generally brick red with a little titanium present. It is found in parts of Kancheepuram, Thanjavur, Nagapattinam and the Nilgiris districts.

Black Soil: The black clayey alluvium rich soil is known as black cotton soil which is found in parts of Coimbatore, Madurai, Dindigul, Tuticorin and Tirunelveli and in patches in the districts of Kancheepuram, Vellore, Salem, Dharmapuri, Ramanathapuram, Virudunagar and the Nilgiris.

Alluvial Soil: Coastal and deltaic areas of Thanjavur, Nagapattinam, Tiruchirappalli, Cuddalore, Kancheepuram, Tirunelveli, Tuticorin, Kanyakumari, Ramanathapuram and Sivaganga districts have this kind of soil.

Saline Soil: These soils are found in the regions of poor drainage and high evaporation. It is found in patches in all the districts except Kanyakumari and the Nilgiris.

FORESTS

The total area under forest is 21,072 sq. km. of which 17,264 sq. km are reserved forests and 3,808 sq. km. are reserved lands. This constitutes only 16.6% of the total geographical area.

POPULATION

The population of Tamil Nadu is 55.638 millions as per 1991 census.

AGRICULTURE 2004–05 (P)

Total Cultivated Area (Ha)	5889069
Net Area Sown (Ha)	5097011
Area Sown more than once (Ha)	792058

Area and Production of Principal Crops	Area (Ha)(in '000)	Production ('000 Tonnes)
Paddy (Rice)	1873	5062
Millets and Other Cereals	824	868
Pulses	590	216
Sugarcane (Cane)	222	24457
Groundnut	616	1005
Gingelly	73	34
Cotton (bales of 170 Kg. lint)	129	195

Agricultural Land Holdings (as per 2000–01 Agricultural Census) (P)

Holdings (in Nos.)	7858887
Area (Ha)	6971516
Average size of Holdings (Ha)	0.89

Land Utilisation

Classification	(Area in Hec.) 2004-05
A. By Professional Survey	13026645
B. By Village Papers	13026645
1. Forests	2122069
2. Barren and Unculturable land	509275
3. Land put to Non-agricultural uses	2124564
4. Culturable Waste	374026
5. Permanent Pastures and other grazing lands	113563
6. Land under misc. tree crops and groves not included in the net area sown	290072
7. Current fallow lands	691926
8. Other fallow lands	1704139
9. Net area sown	5097011
Area sown more than once	792058
Gross Area Sown	5889069

Source: Department of Economics and Statistics, Chennai-6.

ANNEXURE-13

Area, Production and Productivity of Principal Crops in Tamil Nadu (2004–05)

I. Food Crops

A. CEREALS	Area (ha)	Production (t)	Productivity (kg/ha)
1. Rice	1872822	5061622	2703
2. Cholan (Jowar)	376739	252063	669
3. Cumbu (Bajra)	97608	124300	1273
4. Maize	189893	294717	1552
5. Ragi	108845	154085	1416
6. Small Millets	50648	42826	846
7. Total Cereals	2696555	5929613	2199
B. PULSES			
8. Bengal gram	6420	3942	614
9. Red gram	43416	28979	667
10. Black gram	226364	82998	367
11. Green gram	154959	61760	399
12. Horse gram	67513	20110	298
13. Other Pulses	91578	18642	204
14. Total Pulses	590250	216431	367
15. Total Foodgrains (7 + 14)	3286805	6146044	1870
C. OIL SEEDS			
16. Groundnut	615877	1005342	1632
17. Gingelly	72725	33840	465
18. Castor	8269	2598	314
19. Coconut (in Nuts)	357056	* 40970	** 11474
20. Other Oil Seeds	25124	—	—
21. Total Oil Seeds	1079051	—	—
D. OTHER CROPS			
22. Cotton	129364	^ 185960	244
23. Sugarcane #	222188	24457244	\$ 110
24. Tobacco	6049	9274	1533
25. Chillies	66990	44631	666
26. All other crops	1098622	—	—
27. Total (Other Crops)	1523213	—	—
28. Total Crops (15 + 27)	5889069	—	—

@ - In terms of Rice; * - In lakh nuts; ** - Nuts per Hectare, ^ - in Bales of 170 kg lint each; # - In terms of Cane; \$ - t/Hectare;

Source: Department of Economics and Statistics, Chennai-600 006.

ANNEXURE-14

Area under Principal Crops by Districts (2004–05) in Tamil Nadu (in ha)

<i>Sl. No.</i>	<i>District</i>	<i>Rice</i>	<i>Cholam</i>	<i>Cumbu</i>	<i>Ragi</i>	<i>Maize</i>
1.	Kancheepuram	101674	2	26	855	27
2.	Thiruvallur	66734	187	1950	199	0
3.	Cuddalore	114599	1327	3176	201	3950
4.	Villupuram	163696	2004	20439	1827	1713
5.	Vellore	29399	12464	4517	4263	1040
6.	Thiruvannamalai	116820	1677	6051	2882	286
7.	Salem	27304	15522	3768	10421	13785
8.	Namakkal	9042	24633	345	132	1975
9.	Dharmapuri	13915	21473	1807	17798	202
10.	Krishnagiri	17620	4068	186	57732	103
11.	Erode	55347	745	1333	8065	15759
12.	Coimbatore	7239	94888	460	167	24692
13.	The Nilgiris	1443	0	0	0	0
14.	Tiruchirappalli	62178	38009	3349	136	6441
15.	Karur	18233	37549	5192	16	176
16.	Perambalur	46434	14656	1816	79	57423
17.	Pudukottai	94032	1368	35	356	914
18.	Thanjavur	160608	0	6	35	840
19.	Nagapattinam	153139	0	5	0	29
20.	Thiruvarur	148608	0	0	4	9
21.	Madurai	60368	10605	5201	122	826
22.	Theni	16635	14238	5338	74	6172
23.	Dindigul	21031	53098	3997	112	34067
24.	Ramanathapuram	126607	3029	1237	1705	137
25.	Virudhunagar	29713	11596	5585	414	8236
26.	Sivagangai	85141	247	57	706	2
27.	Tirunelveli	86832	2730	767	342	6886
28.	Thoothukudi	16415	10624	20965	202	4203
29.	Kanyakumari	22016	0	0	0	0
	STATE	1872822	376739	97608	108845	189893

ANNEXURE-14 contd.

<i>Sl. No.</i>	<i>District</i>	<i>Other cereals</i>	<i>Total cereals</i>	<i>Bengal Gram</i>	<i>Red gram</i>	<i>Green gram</i>
1.	Kancheepuram	0	102584	0	33	668
2.	Thiruvallur	4	69074	1	1427	8230
3.	Cuddalore	2752	126005	0	664	3489
4.	Villupuram	2127	191806	0	509	381
5.	Vellore	4815	56498	2	13774	2210
6.	Thiruvannamalai	4766	132482	73	2578	1399
7.	Salem	2238	73038	163	1224	3165
8.	Namakkal	373	36500	16	1307	8565
9.	Dharmapuri	21587	76782	756	2488	1080
10.	Krishnagiri	2993	82702	9	2656	614
11.	Erode	37	81286	8	1428	5644
12.	Coimbatore	28	127474	4146	296	5435
13.	The Nilgiris	5	1448	0	0	0
14.	Tiruchirappalli	294	110407	41	2397	630
15.	Karur	1	61167	0	4702	117
16.	Perambalur	1207	121615	6	995	254
17.	Pudukottai	115	96820	0	1607	220
18.	Thanjavur	18	161507	0	50	8709
19.	Nagapattinam	0	153173	0	0	21984
20.	Thiruvarur	0	148621	0	1	27053
21.	Madurai	3983	81105	106	1025	3955
22.	Theni	173	42630	0	2975	164
23.	Dindigul	178	112483	904	563	3438
24.	Ramanathapuram	896	133611	0	0	61
25.	Virudhunagar	1475	57019	128	381	9917
26.	Sivagangai	14	86167	0	265	99
27.	Tirunelveli	214	97771	10	33	11495
28.	Thoothukudi	355	52764	51	38	25883
29.	Kanyakumari	0	22016	0	0	0
	STATE	50648	2696555	6420	43416	154959

ANNEXURE-14 contd.

<i>Sl. No.</i>	<i>District</i>	<i>Black gram</i>	<i>Horse gram</i>	<i>Other pulses</i>	<i>Total pulses</i>	<i>Total food grains</i>
1.	Kancheepuram	3054	82	598	4435	107019
2.	Thiruvallur	1190	168	169	11185	80259
3.	Cuddalore	31563	57	86	35859	161864
4.	Villupuram	15995	457	2040	19382	211188
5.	Vellore	4380	5189	4285	29840	86338
6.	Thiruvannamalai	4172	3855	2131	14208	146690
7.	Salem	3019	2191	6927	16689	89727
8.	Namakkal	3518	2102	2010	17518	54018
9.	Dharmapuri	1706	13752	6809	26591	103373
10.	Krishnagiri	427	16010	5403	25119	107821
11.	Erode	1962	8442	13098	30582	111868
12.	Coimbatore	2186	5056	17642	34761	162235
13.	The Nilgiris	0	0	1	1	1449
14.	Tiruchirappalli	4401	852	563	8884	119291
15.	Karur	404	1519	994	7736	68903
16.	Perambalur	1383	19	35	2692	124307
17.	Pudukottai	919	130	534	3410	100230
18.	Thanjavur	13708	0	2	22469	183976
19.	Nagapattinam	45465	0	0	67449	220622
20.	Thiruvarur	39341	0	4	66399	215020
21.	Madurai	1563	196	2438	9283	90388
22.	Theni	185	626	5117	9067	51697
23.	Dindigul	5271	5103	13365	28644	141127
24.	Ramanathapuram	2105	13	776	3055	136666
25.	Virudhunagar	5455	329	1177	17387	74406
26.	Sivagangai	418	6	565	1353	87520
27.	Tirunelveli	16038	684	3824	32084	129855
28.	Thoothukudi	14469	666	752	41859	94623
29.	Kanyakumari	2067	9	233	2309	24325
	STATE	226364	67513	91578	590250	3286805

ANNEXURE-14-contd.

<i>Sl. No.</i>	<i>District</i>	<i>Sugarcane</i>	<i>Cotton</i>	<i>Groundnut</i>	<i>Gingelly</i>	<i>Castor</i>
1.	Kancheepuram	4174	114	25137	2132	4
2.	Thiruvallur	3240	0	22774	2358	36
3.	Cuddalore	29734	1572	20570	4201	27
4.	Villupuram	39444	5215	58999	6721	40
5.	Vellore	12325	1885	55781	1569	562
6.	Thiruvannamalai	17231	2576	108633	844	4
7.	Salem	6399	14958	29887	1302	973
8.	Namakkal	9476	3488	48111	667	2910
9.	Dharmapuri	9819	7260	15211	363	149
10.	Krishnagiri	1645	2572	15391	429	653
11.	Erode	19948	5434	44660	17277	1347
12.	Coimbatore	5883	11547	19147	1125	236
13.	The Nilgiris	11	0	0	5	0
14.	Tiruchirappalli	4470	2715	15456	657	598
15.	Karur	2842	445	7114	4721	83
16.	Perambalur	10721	2794	31755	3610	157
17.	Pudukottai	7472	246	25668	756	0
18.	Thanjavur	12000	2225	8217	7243	4
19.	Nagapattinam	2550	3843	3306	444	0
20.	Thiruvarur	1834	3035	1160	1106	1
21.	Madurai	3312	12035	8108	999	28
22.	Theni	5940	5137	2599	415	77
23.	Dindigul	4185	3703	18720	1552	131
24.	Ramanathapuram	260	5413	8607	1772	11
25.	Virudhunagar	2194	17439	7487	3783	67
26.	Sivagangai	2248	489	7295	216	8
27.	Tirunelveli	2771	6625	3945	2375	108
28.	Thoothukudi	60	6599	2097	4083	55
29.	Kanyakumari	0	0	42	0	0
	STATE	222188	129364	615877	72725	8269

Source: Department of Economics and Statistics, Chennai-600 006.

* L. Bales–Lakh Bales, ** L.Tonnes–Lakh Tonnes.

ANNEXURE-15

Time Series Data Area of Important Crops in Tamil Nadu ('000 ha)

<i>Year</i>	<i>Rice</i>	<i>Cholam</i>	<i>Cumbu</i>	<i>Ragi</i>	<i>Total cereals</i>	<i>Total pulses</i>	<i>Groundnut</i>
1989-90	1963	587	261	172	3203	821	1016
1990-91	1856	541	274	170	3038	847	963
1991-92	2118	512	246	158	3212	776	1099
1992-93	2184	484	220	151	3206	739	1188
1993-94	2306	506	213	158	3337	690	1158
1994-95	2229	432	192	145	3158	691	1080
1995-96	1951	383	173	122	2762	577	933
1996-97	2174	395	165	111	2977	582	902
1997-98	2261	380	169	107	3051	591	868
1998-99	2275	365	154	120	3039	637	858
1999-00	2164	351	158	123	2940	693	759
2000-01	2080	331	129	127	2813	688	699
2001-02	2060	317	125	125	2766	686	663
2002-03	1516	320	102	104	2229	563	502
2003-04	1397	402	159	118	2300	537	592
2004-05	1873	377	98	109	2699	590	616

ANNEXURE-15 contd.

<i>Year</i>	<i>Gingelly</i>	<i>Sugarcane</i>	<i>Cotton</i>	<i>Gross area sown</i>	<i>Net area sown</i>	<i>Gross area irrigated</i>	<i>Net area irrigated</i>
1989-90	140	222	281	6822	5662	3045	2497
1990-91	138	233	239	6632	5578	2894	2373
1991-92	149	238	258	6977	5726	3257	2605
1992-93	141	216	267	7067	5814	3385	2698
1993-94	129	249	229	7158	5901	3544	2800
1994-95	127	328	255	7026	5790	3588	2903
1995-96	100	326	261	6267	5342	3183	2625
1996-97	103	260	252	6457	5486	3347	2812
1997-98	88	283	228	6558	5581	3519	2945
1998-99	99	306	219	6627	5635	3635	3019
1999-00	112	316	178	6519	5464	3585	2972
2000-01	104	315	170	6338	5303	3490	2888
2001-02	84	321	164	6226	5172	3412	2801
2002-03	64	261	76	5191	4590	2622	2310
2003-04	84	192	98	5316	4689	2479	2148
2004-05	73	222	129	5889	5097	3087	2637

Source: Department of Economics and Statistics, Chennai-600 006.

ANNEXURE-16

Area and Production of Rice, Sorghum and Cumbu in Tamil Nadu-district wise
(2004–2005)

<i>Sl. No.</i>	<i>Districts</i>	<i>Rice area (ha)</i>	<i>Rice production (t)</i>	<i>Sorghum area (ha)</i>	<i>Sorghum production (t)</i>	<i>Cumbu area (ha)</i>	<i>Cumbu production (t)</i>
1.	Kancheepuram	101674	307110	2	2	26	44
2.	Thiruvallur	66734	199886	187	141	1950	3678
3.	Cuddalore	114599	315702	1327	524	3176	4640
4.	Villupuram	163696	525850	2004	1444	20439	19546
5.	Vellore	29399	90145	12464	16335	4517	4927
6.	Thiruvannamalai	116820	330487	1677	1131	6051	1965
7.	Salem	27304	96626	15522	9686	3768	5604
8.	Namakkal	9042	28793	24633	18403	345	412
9.	Dharmapuri	13915	38568	21473	24999	1807	2046
10.	Krishnagiri	17620	45254	4068	2576	186	260
11.	Erode	55347	216247	745	446	1333	1673
12.	Coimbatore	7239	24454	94888	32292	460	865
13.	The Nilgiris	1443	4763	0	0	0	0
14.	Tiruchirappalli	62178	205397	38009	17263	3349	1391
15.	Karur	18233	54278	37549	9671	5192	1463
16.	Perambalur	46434	108510	14656	14036	1816	2748
17.	Pudukottai	94032	277277	1368	876	35	41
18.	Thanjavur	160608	439323	0	0	6	14
19.	Nagapattinam	153139	140662	0	0	5	14
20.	Thiruvarur	148608	239805	0	0	0	0
21.	Madurai	60368	196583	10605	10754	5201	6376
22.	Theni	16635	67094	14238	22045	5338	8010
23.	Dindigul	21031	74246	53098	46369	3997	5348
24.	Ramanathapuram	126607	254700	3029	3499	1237	1467
25.	Virudhunagar	29713	86992	11596	7388	5585	6718
26.	Sivagangai	85141	179535	247	189	57	123
27.	Tirunelveli	86832	358920	2730	5251	767	1273
28.	Thoothukudi	16415	67929	10624	6743	20965	43654
29.	Kanyakumari	22016	86486	0	0	0	0
	STATE	1872822	5061622	376739	252063	97608	124300

ANNEXURE-17

Area and Production of Maize and Ragi in Tamil Nadu-district wise (2004–05)

<i>Sl. No.</i>	<i>Districts</i>	<i>Maize area (ha)</i>	<i>Maize production (t)</i>	<i>Ragi area (ha)</i>	<i>Ragi production (t)</i>
1.	Kancheepuram	27	42	855	1578
2.	Thiruvallur	0	0	199	339
3.	Cuddalore	3950	7589	201	409
4.	Villupuram	1713	2491	1827	3999
5.	Vellore	1040	1726	4263	8820
6.	Thiruvannamalai	286	478	2882	4528
7.	Salem	13785	25639	10421	18004
8.	Namakkal	1975	3682	132	247
9.	Dharmapuri	202	223	17798	25796
10.	Krishnagiri	103	113	57732	73348
11.	Erode	15759	36028	8065	9463
12.	Coimbatore	24692	27779	167	261
13.	The Nilgiris	0	0	0	0
14.	Tiruchirappalli	6441	8428	136	187
15.	Karur	176	431	16	37
16.	Perambalur	57423	67998	79	116
17.	Pudukottai	914	1877	356	574
18.	Thanjavur	840	2246	35	80
19.	Nagapattinam	29	75	0	0
20.	Thiruvarur	9	27	4	9
21.	Madurai	826	1657	122	187
22.	Theni	6172	12377	74	123
23.	Dindigul	34067	67489	112	163
24.	Ramanathapuram	137	160	1705	2843
25.	Virudhunagar	8236	16693	414	781
26.	Sivagangai	2	4	706	1146
27.	Tirunelveli	6886	6130	342	734
28.	Thoothukudi	4203	3339	202	313
29.	Kanyakumari	0	0	0	0
	STATE	189893	294717		154085

ANNEXURE-18

**Area of Bengal Gram, Red Gram and Green Gram in Tamil Nadu—district wise
(2004–2005) in ha**

<i>Sl.No.</i>	<i>Districts</i>	<i>Bengal gram</i>	<i>Redgram</i>	<i>Green gram</i>	<i>Black gram</i>	<i>Horse gram</i>
1.	Kancheepuram	0	33	668	3054	82
2.	Thiruvallur	1	1427	8230	1190	168
3.	Cuddalore	0	664	3489	31563	57
4.	Villupuram	0	509	381	15995	457
5.	Vellore	2	13774	2210	4380	5189
6.	Thiruvannamalai	73	2578	1399	4172	3855
7.	Salem	163	1224	3165	3019	2191
8.	Namakkal	16	1307	8565	3518	2102
9.	Dharmapuri	756	2488	1080	1706	13752
10.	Krishnagiri	9	2656	614	427	16010
11.	Erode	8	1428	5644	1962	8442
12.	Coimbatore	4146	296	5435	2186	5056
13.	The Nilgiris	0	0	0	0	0
14.	Tiruchirappalli	41	2397	630	4401	852
15.	Karur	0	4702	117	404	1519
16.	Perambalur	6	995	254	1383	19
17.	Pudukottai	0	1607	220	919	130
18.	Thanjavur	0	50	8709	13708	0
19.	Nagapattinam	0	0	21984	45465	0
20.	Thiruvarur	0	1	27053	39341	0
21.	Madurai	106	1025	3955	1563	196
22.	Theni	0	2975	164	185	626
23.	Dindigul	904	563	3438	5271	5103
24.	Ramanathapuram	0	0	61	2105	13
25.	Virudhunagar	128	381	9917	5455	329
26.	Sivagangai	0	265	99	418	6
27.	Tirunelveli	10	33	11495	16038	684
28.	Thoothukudi	51	38	25883	14469	666
29.	Kanyakumari	0	0	0	2067	9
	STATE	6420	43416	154959	226364	67513

ANNEXURE-19

Area and Production of Sugarcane and Cotton in Tamil Nadu-district wise
(2004–2005)

<i>Sl. No.</i>	<i>Districts</i>	<i>Sugarcane area (ha)</i>	<i>Sugarcane production</i>	<i>Cotton area (ha)</i>	<i>Cotton production (in bales of 170 kg lint each)</i>
1.	Kancheepuram	4174	397085	114	223
2.	Thiruvallur	3240	329440	0	0
3.	Cuddalore	29734	3549318	1572	1734
4.	Villupuram	39444	4511684	5215	9582
5.	Vellore	12325	1000691	1885	5114
6.	Thiruvannamalai	17231	1596624	2576	5271
7.	Salem	6399	583832	14958	28430
8.	Namakkal	9476	1306920	3488	5486
9.	Dharmapuri	9819	783163	7260	10699
10.	Krishnagiri	1645	88236	2572	3531
11.	Erode	19948	2675825	5434	12272
12.	Coimbatore	5883	679798	11547	14808
13.	The Nilgiris	11	1211	0	0
14.	Tiruchirappalli	4470	391871	2715	3812
15.	Karur	2842	257026	445	760
16.	Perambalur	10721	1220543	2794	4827
17.	Pudukottai	7472	930638	246	314
18.	Thanjavur	12000	1362612	2225	5235
19.	Nagapattinam	2550	222240	3843	6530
20.	Thiruvarur	1834	201877	3035	4245
21.	Madurai	3312	404518	12035	6820
22.	Theni	5940	723302	5137	7106
23.	Dindigul	4185	484598	3703	6173
24.	Ramanathapuram	260	28619	5413	3802
25.	Virudhunagar	2194	218450	17439	16648
26.	Sivagangai	2248	195502	489	576
27.	Tirunelveli	2771	305017	6625	14854
28.	Thoothukudi	60	6604	6599	7108
29.	Kanyakumari	0	0	0	0
	STATE	222188	24457244	129364	185960

ANNEXURE-20

Area and Production of Groundnut, Gingelly and Area of Castor in Tamil Nadu-district wise (2004–2005)

<i>Sl.No.</i>	<i>Districts</i>	<i>Groundnut area (ha)</i>	<i>Groundnut production</i>	<i>Gingelly area (ha)</i>	<i>Gingelly-production</i>	<i>Castor area (ha)</i>
1.	Kancheepuram	25137	63376	2132	773	4
2.	Thiruvallur	22774	78997	2358	1206	36
3.	Cuddalore	20570	49280	4201	1439	27
4.	Villupuram	58999	114140	6721	2667	40
5.	Vellore	55781	72625	1569	983	562
6.	Thiruvannamalai	108633	126710	844	251	4
7.	Salem	29887	35009	1302	858	973
8.	Namakkal	48111	51156	667	422	2910
9.	Dharmapuri	15211	24621	363	163	149
10.	Krishnagiri	15391	23792	429	57	653
11.	Erode	44660	82524	17277	13852	1347
12.	Coimbatore	19147	24227	1125	392	236
13.	The Nilgiris	0	0	5	2	0
14.	Tiruchirappalli	15456	26820	657	373	598
15.	Karur	7114	14341	4721	1339	83
16.	Perambalur	31755	37777	3610	1016	157
17.	Pudukottai	25668	36746	756	285	0
18.	Thanjavur	8217	18413	7243	1332	4
19.	Nagapattinam	3306	5630	444	124	0
20.	Thiruvarur	1160	2892	1106	315	1
21.	Madurai	8108	10812	999	335	28
22.	Theni	2599	6208	415	147	77
23.	Dindigul	18720	49228	1552	697	131
24.	Ramanathapuram	8607	19221	1772	320	11
25.	Virudhunagar	7487	8558	3783	1228	67
26.	Sivagangai	7295	10319	216	70	8
27.	Tirunelveli	3945	8869	2375	1035	108
28.	Thoothukudi	2097	3000	4083	2159	55
29.	Kanyakumari	42	51	0	0	0
	STATE	615877	1005342	72725	33840	8269

ANNEXURE-21

Three Largest Producing States of Important Crops during 2005–06

<i>Crop/Group of crops</i>	<i>States</i>	<i>Production (m.t.)</i>
I. Foodgrains		
Rice	West Bengal	14.51
	Andhra Pradesh	11.70
	Uttar Pradesh	11.13
Wheat	Uttar Pradesh	24.07
	Punjab	14.49
	Haryana	8.86
Maize	Andhra Pradesh	3.09
	Karnataka	2.73
	Bihar	1.36
Total Coarse Cereals	Karnataka	6.56
	Maharashtra	6.09
	Rajasthan	4.53
Total Pulses	Madhya Pradesh	3.23
	Uttar Pradesh	2.23
	Maharashtra	2.01
Total Foodgrains	Uttar Pradesh	40.41
	Punjab	25.18
	Andhra Pradesh	16.95
II. Oilseeds		
Groundnut	Gujarat	3.39
	Andhra Pradesh	1.37
	Tamil Nadu	1.10
Rapeseed and Mustard	Rajasthan	4.42
	Uttar Pradesh	0.91
	Madhya Pradesh	0.85
Soyabean	Madhya Pradesh	4.50
	Maharashtra	2.53
	Rajasthan	0.86
Sunflower	Karnataka	0.79
	Andhra Pradesh	0.30
	Maharashtra	0.21
Total Oilseeds	Rajasthan	5.96
	Madhya Pradesh	5.72
	Gujarat	4.68

III. Other Cash Crops

Sugarcane	Uttar Pradesh	125.47
	Maharashtra	38.85
	Tamil Nadu	35.11
Cotton [@]	Gujarat	6.77
	Maharashtra	3.16
	Punjab	2.40
Jute and Mesta ^{\$}	West Bengal	8.11
	Bihar	1.39
	Assam	0.60
Potato	Uttar Pradesh	9.99
	West Bengal	7.46
	Bihar	1.23
Onion	Maharashtra	2.47
	Gujarat	2.13
	Karnataka	0.87

[@] : Production in million bales of 170 kgs. each.

^{\$} : Production in million bales of 180 kg. each.

ANNEXURE-22

Area, Production and Yield of Principal Crops in various Countries in 2003

<i>Country</i>	<i>Area</i> (<i>'000 ha</i>)	<i>Production</i> (<i>'000 t</i>)	<i>Yield</i> (<i>kg/ha</i>)
1. Paddy			
World	153522	589126	3837
Bangladesh	11100*	38060*	3429
Brazil	3150	10199	3238
China	27398*	166417*	6074
Egypt	615*	5800F	9431F
India	44000*	132013	3000F
Indonesia	11477	52079	4538
Japan	1665	9740	5850F
Myanmar	6650*	24640*	3705F
Pakistan	2210*	6751*	3055F
Philippines	4094	14031	3427F
Russian Federation	142	450	3175
Thailand	11000*	27000*	2455F
U.S.A.	1213	9034	7448F
Vietnam	7449	34519	4634F
2. Wheat			
World	208764	556349	2665
Argentina	7000	14530	2076F
Australia	12456	24900	1999F
Bangladesh	778*	1550*	1992F
Canada	10467	23552	2250F
China	22040*	86100	3907
Egypt	1000*	6155*	6155F
France	4905	30582	6235F
India	24886	65129	2617F
Iran	6500*	12900*	1985F
Italy	2267	6243	2754F
Pakistan	8069	19210	2381F
Romania	1411	2479	1757F
Russian Federation	19960*	34062	1707F
Spain	2218	6290	2836F
Syria	1796	4913	2736F
Turkey	9400F	19000*	2021F

U.K.	1837	14288*	7778F
U.S.A	21383	63590	2974F
Ukraine	2625	3600	1371F
3. Maize			
World	142685	638043	4472
Argentina	2323	15040	6474F
Brazil	12935	47809	3696F
Canada	1226	9587	7819F
China	23520*	114175	4854
France	1667	11898	7137F
Egypt	830F	6400F	7711F
Hungry	1150*	4534	3943F
India	7000*	14800*	2114F
Indonesia	3355	10910	3252F
Italy	1159	8978	7744F
Mexico	7781	19652	2526F
Pakistan	875*	1275*	1457F
Philippines	2485*	4478	1802F
Romania	3119	9577	3070F
Russian Fed	648	2113	3262F
Turkey	575	2800	4870F
U.S.A.	28789	256905	8924F
4. Groundnut (in shell)			
World	26463	35658	1347
Argentina	156	316	2026F
Brazil	85	177	2082F
China	5125F	13447	2624
India	8000*	7500*	938F
Indonesia	683	1377	2016F
Japan	10	22	2308F
Myanmar	575*	730*	1270F
Nigeria	2800F	2700F	964F
Senegal	900F	900F	1000F
Sudan	1900F	1200F	632F
Thailand	87*	132F	1517F
U.S.A.	531	1880	3540F
Uganda	211F	150F	711F
Vietnam	240	400	1667F
5. Sugarcane			
World	20420	1333253	65293
Argentina	296F	14250F	65254F
Australia	423	36012*	85135F
Bangladesh	166	6838	41212

(Contd.)

<i>Country</i>	<i>Area (‘000 ha)</i>	<i>Production (‘000 t)</i>	<i>Yield (kg/ha)</i>
Brazil	5343	386232	72290F
China	1328F	92370	69556F
Colombia	435F	36600F	84138F
Cuba	654	22902	35000F
Egypt	132F	12000F	90909F
Guatemala	186F	17500F	93914F
India	4608	289630	62859F
Indonesia	350*	25600*	73143F
Mauritius	72	5199	72587F
Mexico	639	45126	70614F
Thailand	970*	64408*	66400F
Pakistan	1086	52056	47934F
Philippines	385*	25835*	67104F
U.S.A.	404	31301	77515F
6. Tobacco Leaves			
World	3938	6195	1573
Argentina	61F	126F	2066F
Bangladesh	33F	40F	1212F
Brazil	389	648	1666F
Bulgaria	38F	60F	1579F
Canada	23F	60F	2609F
China	1353F	2308*	1706
France	9	24	2768F
Greece	57*	121*	2123F
India	435*	595*	1368
Indonesia	156F	135*	865F
Italy	37*	106*	2887F
Japan	23*	60*	2563F
Korea Republic	21F	48F	2264F
Pakistan	50*	95	1917F
Philippines	42F	51*	1200F
Poland	10	20*	1942F
Spain	14	44	3129F
Thailand	415	65F	1585F
Turkey	193F	152	787F
U.S.A.	168	377	2238F
Zimbabwe	81F	178F	2216F

* : Unofficial figure,

F: FAO Estimate,

Source: FAO Production Year Book-2003.

ANNEXURE-23

All-India Area, Production and Yield of Rice from 1950–51 to 2005–06

<i>Year</i>	<i>Area (m.ha)</i>	<i>Production (m.t)</i>	<i>Yield (kg/ha)</i>	<i>% Coverage under irrigation</i>
1950–51	30.81	20.58	668	31.7
1951–52	29.83	21.30	714	31.7
1952–53	29.97	22.90	764	32.3
1953–54	31.29	28.21	902	33.6
1954–55	30.77	25.22	820	34.4
1955–56	31.52	27.56	874	34.9
1956–57	32.28	29.04	900	35.4
1957–58	32.30	25.53	790	36.4
1958–59	33.17	30.85	930	36.3
1959–60	33.82	31.68	937	35.8
1960–61	34.13	34.58	1013	36.8
1961–62	34.69	35.66	1028	37.5
1962–63	35.69	33.21	931	37.4
1963–64	35.81	37.00	1033	37.1
1964–65	36.46	39.31	1078	37.3
1965–66	35.47	30.59	862	36.5
1966–67	35.25	30.44	863	37.9
1967–68	36.44	37.61	1032	38.6
1968–69	36.97	39.76	1076	38.4
1969–70	37.68	40.43	1073	38.2
1970–71	37.59	42.22	1123	38.4
1971–72	37.76	43.07	1141	37.2
1972–73	36.69	39.24	1070	39.1
1973–74	38.29	44.05	1151	38.4
1974–75	37.89	39.58	1045	38.8
1975–76	39.48	48.74	1235	38.7
1976–77	38.51	41.92	1089	38.4
1977–78	40.28	52.67	1308	40.2
1978–79	40.48	53.77	1328	41.6
1979–80	39.42	42.33	1074	42.8
1980–81	40.15	53.63	1336	40.7
1981–82	40.71	53.25	1308	41.5
1982–83	38.26	47.12	1231	42.0
1983–84	41.24	60.10	1457	42.7

(Contd.)

<i>Year</i>	<i>Area (m.ha)</i>	<i>Production (m.t)</i>	<i>Yield (kg/ha)</i>	<i>% Coverage under irrigation</i>
1984-85	41.16	58.34	1417	43.7
1985-86	41.14	63.83	1552	42.9
1986-87	41.17	60.56	1471	44.1
1987-88	38.81	56.86	1465	43.6
1988-89	41.73	70.49	1689	45.8
1989-90	42.17	73.57	1745	46.1
1990-91	42.69	74.29	1740	45.5
1991-92	42.65	74.68	1751	47.3
1992-93	41.78	72.86	1744	48.0
1993-94	42.54	80.30	1888	48.6
1994-95	42.81	81.81	1911	49.8
1995-96	42.84	76.98	1797	49.9
1996-97	43.43	81.74	1882	51.0
1997-98	43.45	82.53	1900	50.8
1998-99	44.80	86.08	1921	52.3
1999-00	45.16	89.68	1986	53.9
2000-01	44.71	84.98	1901	53.6
2001-02	44.90	93.34	2079	53.2
2002-03	41.18	71.82	1744	50.2
2003-04	42.59	88.53	2077	52.6
2004-05	41.91	83.13	1984	NA
2005-06	43.66	91.79	2102	NA

Note: The yield rates given above have been worked out on the basis of production and area figures taken in '000 units.

ANNEXURE-24

Area, Production and Yield of Rice during 2004–05 and 2005–06 in major Rice Producing States

Area–m.ha
Production–m.t.
Yield–Kg./ha

State	2005–06						2004–05					
	Area	% of total area	Production	% of total production	Cumulative % of total production	Yield	Area	% of total area	Production	% of total production	Cumulative % of total production	Yield
West Bengal	5.78	13.24	14.51	15.81	15.81	2509	5.78	13.79	14.88	17.90	17.90	2574
Andhra Pradesh	3.98	9.12	11.70	12.75	28.55	2939	3.09	7.37	9.60	11.55	29.45	3111
Uttar Pradesh	5.58	12.78	11.13	12.13	40.68	1996	5.34	12.74	9.56	11.50	40.95	1790
Punjab	2.64	6.05	10.19	11.10	51.78	3858	2.65	6.32	10.44	12.56	53.51	3943
Orissa	4.48	10.26	6.86	7.47	59.25	1531	4.47	10.67	6.47	7.78	61.29	1446
Karnataka	1.49	3.41	5.74	6.25	65.51	3868	1.31	3.13	3.55	4.27	65.56	2712
Tamil Nadu	2.05	4.70	5.22	5.69	71.20	2546	1.87	4.46	5.06	6.09	71.65	2703
Chhattisgarh	3.75	8.59	5.01	5.46	76.65	1337	3.75	8.95	4.38	5.27	76.92	1170
Assam	2.42	5.54	3.55	3.87	80.52	1468	2.38	5.68	3.47	4.17	81.09	1460
Bihar	3.25	7.44	3.50	3.81	84.33	1075	3.12	7.44	2.47	2.97	84.06	792
Haryana	1.05	2.40	3.21	3.50	87.83	3051	1.03	2.46	3.02	3.63	87.69	2941
Maharashtra	1.52	3.48	2.70	2.94	90.77	1779	1.52	3.63	2.16	2.60	90.29	1425
Madhya Pradesh	1.66	3.80	1.66	1.81	92.58	999	1.62	3.87	1.17	1.41	91.70	720
Jharkhand	1.35	3.09	1.56	1.70	94.28	1150	1.29	3.08	1.68	2.02	93.72	1305
Gujarat	0.67	1.53	1.30	1.42	95.70	1949	0.69	1.65	1.24	1.49	95.21	1806
Kerala	0.28	0.64	0.63	0.69	96.38	2284	0.29	0.69	0.67	0.81	96.02	2301
Others	1.71	3.92	3.32	3.62	100.00	@	1.71	4.08	3.31	3.98	100.00	@
All India	43.66	100.00	91.79	100.00		2102	41.91	00.00	83.13	100.00		1984

@ - Since area/production is low in individual states, yield rate is not worked out.

Note: States have been arranged in descending order of percentage share of production during 2005–06.

* Provisional.

ANNEXURE-25

All-India Area, Production and Yield of Wheat from 1950–51 to 2005–06

<i>Year</i>	<i>Area (m.ha)</i>	<i>Production (m.t)</i>	<i>Yield (kg./ha)</i>
1950–51	9.75	6.46	663
1951–52	9.47	6.18	653
1952–53	9.83	7.50	763
1953–54	10.68	8.02	750
1954–55	11.26	9.04	803
1955–56	12.37	8.76	708
1956–57	13.52	9.40	695
1957–58	11.73	7.99	682
1958–59	12.62	9.96	789
1959–60	13.38	10.32	772
1960–61	12.93	11.00	851
1961–62	13.57	12.07	890
1962–63	13.59	10.78	793
1963–64	13.50	9.85	730
1964–65	13.42	12.26	913
1965–66	12.57	10.40	827
1966–67	12.84	11.39	887
1967–68	14.99	16.54	1103
1968–69	15.96	18.65	1169
1969–70	16.63	20.09	1208
1970–71	18.24	23.83	1307
1971–72	19.14	26.41	1380
1972–73	19.46	24.74	1271
1973–74	18.58	21.78	1172
1974–75	18.01	24.10	1338
1975–76	20.45	28.84	1410
1976–77	20.92	29.01	1387
1977–78	21.46	31.75	1480
1978–79	22.64	35.51	1568
1979–80	22.17	31.83	1436
1980–81	22.28	36.31	1630
1981–82	22.14	37.45	1691
1982–83	23.57	42.79	1816

1983-84	24.67	45.48	1843
1984-85	23.56	44.07	1870
1985-86	23.00	47.05	2046
1986-87	23.13	44.32	1916
1987-88	23.06	46.17	2002
1988-89	24.11	54.11	2244
1989-90	23.50	49.85	2121
1990-91	24.17	55.14	2281
1991-92	23.26	55.69	2394
1992-93	24.59	57.21	2327
1993-94	25.15	59.84	2380
1994-95	25.70	65.77	2559
1995-96	25.01	62.10	2483
1996-97	25.89	69.35	2679
1997-98	26.70	66.35	2485
1998-99	27.52	71.29	2590
1999-2000	27.49	76.37	2778
2000-01	25.73	69.68	2708
2001-02	26.34	72.77	2762
2002-03	25.20	65.76	2610
2003-04	26.60	72.16	2713
2004-05	26.38	68.64	2602
2005-06	26.48	69.35	2619

Note: The yield rates given above have been worked out on the basis of production and area figures taken in '000 units.

ANNEXURE-26

Area, Production and Yield of Wheat during 2004–05 and 2005–06 in major Wheat Producing States

Area–m.ha
Production–m.t.
Yield–Kg./ha

State	2005–06						2004–05					
	Area	% of total area	Production	% of total production	Cumulative % of total production	Yield	Area	% of total area	Production	% of total production	Cumulative % of total production	Yield
Uttar Pradesh	9.16	34.59	24.07	34.71	34.71	2627	9.00	34.12	22.51	32.79	32.79	2502
Punjab	3.47	13.10	14.49	20.89	55.60	4179	3.48	13.19	14.70	21.42	54.21	4221
Haryana	2.30	8.69	8.86	12.78	68.38	3844	2.32	8.79	9.06	13.20	67.41	3901
Madhya Pradesh	3.69	13.94	5.96	8.59	76.97	1613	4.14	15.69	7.18	10.46	77.87	1735
Rajasthan	2.12	8.01	5.87	8.46	85.44	2762	2.01	7.62	5.71	8.32	86.19	2839
Bihar	2.00	7.55	3.24	4.67	90.11	1617	2.03	7.70	3.26	4.75	90.94	1609
Gujarat	0.92	3.47	2.47	3.56	93.67	2700	0.73	2.77	1.81	2.64	93.58	2482
Maharashtra	0.93	3.51	1.30	1.87	95.54	1393	0.76	2.88	1.02	1.49	95.06	1344
West Bengal	0.37	1.40	0.77	1.11	96.65	2109	0.40	1.52	0.84	1.22	96.28	2103
Himachal Pradesh	0.36	1.36	0.68	0.98	97.64	1894	0.36	1.36	0.68	0.99	97.28	1890
Uttaranchal	0.40	1.51	0.65	0.94	98.57	1633	0.39	1.48	0.80	1.17	98.44	2038
Jammu & Kashmir	0.25	0.94	0.44	0.63	99.21	1790	0.25	0.95	0.47	0.68	99.13	1910
Karnataka	0.25	0.94	0.22	0.32	99.52	858	0.24	0.91	0.18	0.26	99.39	740
Jharkhand	0.06	0.23	0.08	0.12	99.64	1340	0.06	0.23	0.15	0.22	99.61	2381
Assam	0.05	0.19	0.05	0.07	99.71	1074	0.06	0.23	0.07	0.10	99.71	1066
Others	0.15	0.57	0.20	0.29	100.00	@	0.15	0.57	0.20	0.29	100.00	@
All India	26.48	100.00	69.35	100.00		2619	26.38	100.00	68.64	100.00		2602

@ - Since area/production is low in individual states, yield rate is not worked out.

Note: States have been arranged in descending order of percentage share of production during 2005–06.

* Provisional.

ANNEXURE-27

All-India Area, Production and Yield of Jowar from 1950–51 to 2005–06 along with percentage coverage under Irrigation

<i>Year</i>	<i>Area (m.ha)</i>	<i>Production (m.t)</i>	<i>Yield (kg./ha)</i>	<i>% Coverage under irrigation</i>
1950–51	15.57	5.50	353	3.0
1951–52	15.94	6.08	381	3.5
1952–53	17.54	7.36	420	3.1
1953–54	17.76	8.08	455	3.1
1954–55	17.46	9.20	527	3.3
1955–56	17.36	6.73	387	3.6
1956–57	16.24	7.33	451	3.4
1957–58	17.31	8.64	499	3.5
1958–59	17.96	9.03	503	3.5
1959–60	17.71	8.58	484	3.6
1960–61	18.41	9.81	533	3.6
1961–62	18.25	8.03	440	3.7
1962–63	18.41	9.75	529	3.7
1963–64	18.38	9.20	501	3.9
1964–65	18.06	9.68	536	3.8
1965–66	17.68	7.58	429	4.1
1966–67	18.05	9.22	511	4.0
1967–68	18.42	10.05	545	3.9
1968–69	18.73	9.80	523	4.5
1969–70	18.61	9.72	522	4.1
1970–71	17.37	8.11	466	3.6
1971–72	16.78	7.72	460	4.4
1972–73	15.51	6.97	449	3.3
1973–74	16.72	9.10	544	4.0
1974–75	16.19	10.41	643	4.6
1975–76	16.09	9.50	591	4.9
1976–77	15.77	10.52	667	5.1
1977–78	16.32	12.06	739	4.9
1978–79	16.15	11.44	708	4.8
1979–80	16.67	11.65	699	4.9
1980–81	15.81	10.43	660	4.7
1981–82	16.60	12.06	727	4.6
1982–83	16.38	10.75	657	4.3

(Contd.)

<i>Year</i>	<i>Area (m.ha)</i>	<i>Production (m.t)</i>	<i>Yield (kg./ha)</i>	<i>% Coverage under irrigation</i>
1983-84	16.43	11.92	725	4.1
1984-85	15.94	11.40	715	4.4
1985-86	16.10	10.20	633	4.5
1986-87	15.95	9.19	576	4.9
1987-88	16.00	12.20	762	4.9
1988-89	14.60	10.17	697	5.8
1989-90	14.84	12.90	869	6.3
1990-91	14.36	11.68	814	5.6
1991-92	12.36	8.10	655	6.5
1992-93	13.04	12.81	982	6.1
1993-94	12.71	11.41	895	6.2
1994-95	11.51	8.97	779	6.7
1995-96	11.33	9.33	823	6.8
1996-97	11.43	10.93	956	6.7
1997-98	10.80	7.53	697	7.3
1998-99	9.79	8.42	859	8.1
1999-2000	10.25	8.68	847	7.7
2000-01	9.86	7.53	764	7.9
2001-02	9.80	7.56	771	8.3
2002-03	9.30	7.01	754	8.5
2003-04	9.33	6.68	716	7.5
2004-05	9.09	7.24	797	NA
2005-06	8.67	7.24	880	NA

Note: The yield rates given above have been worked out on the basis of production and area figures taken in '000 units.

ANNEXURE-28

Area, Production and Yield of Jowar during 2004–05 and 2005–06 in Major Jowar producing States along with Coverage under Irrigation

State	2005–06						2004–05					
	Area	% of total area	Production	% of total production	Cumulative % of total production	Yield	Area	% of total area	Production	% of total production	Cumulative % of total production	Yield
Maharashtra	4.74	54.67	3.90	51.11	51.11	824	4.76	52.37	3.62	50.00	50.00	762
Karnataka	1.52	17.53	1.67	21.89	73.00	1095	1.66	18.26	1.44	19.89	69.89	863
Madhya Pradesh	0.58	6.69	0.63	8.26	81.26	1088	0.66	7.26	0.63	8.70	78.59	957
Andhra Pradesh	0.44	5.07	0.59	7.73	88.99	1324	0.50	5.50	0.52	7.18	85.77	1032
Uttar Pradesh	0.23	2.65	0.24	3.15	92.14	1065	0.25	2.75	0.25	3.45	89.23	1020
Tamil Nadu	0.32	3.69	0.23	3.01	95.15	732	0.38	4.18	0.25	3.45	92.68	669
Rajasthan	0.59	6.81	0.17	2.23	97.38	288	0.57	6.27	0.27	3.73	96.41	464
Gujarat	0.13	1.50	0.15	1.97	99.34	1138	0.18	1.98	0.21	2.90	99.31	1154
Haryana	0.09	1.04	0.02	0.26	99.61	273	0.10	1.10	0.03	0.41	99.72	271
Orissa	0.01	0.12	0.01	0.13	99.74	600	0.01	0.11	0.01	0.14	99.86	545
Others	0.02	0.23	0.02	0.26	100.00	@	0.02	0.22	0.01	0.14	100.00	@
All India	8.67	100.00	7.63	100.00		880	9.09	100.00	7.24	100.00		797

@ - Since area/production is low in individual states, yield rate is not worked out.

Note: States have been arranged in descending order of percentage share of production during 2005–06.

* Provisional.

ANNEXURE-29

**All-India Area, Production and Yield of Bajra from 1950–51 to 2005–06 along with
Percentage Coverage under Irrigation**

<i>Year</i>	<i>Area (m.ha)</i>	<i>Production (m.t)</i>	<i>Yield (kg./ha)</i>	<i>% Coverage under irrigation</i>
1950–51	9.02	2.60	288	3.4
1951–52	9.52	2.35	246	3.8
1952–53	10.77	3.19	296	3.3
1953–54	12.20	4.55	373	3.1
1954–55	11.37	3.52	310	3.6
1955–56	11.34	3.43	302	3.6
1956–57	11.25	2.87	255	3.1
1957–58	11.17	3.62	324	2.9
1958–59	11.43	3.87	338	3.0
1959–60	10.70	3.49	327	2.5
1960–61	11.47	3.28	286	2.8
1961–62	11.28	3.65	323	2.6
1962–63	10.96	3.96	361	2.7
1963–64	11.10	3.88	349	2.3
1964–65	11.83	4.52	382	2.3
1965–66	11.97	3.75	314	2.8
1966–67	12.24	4.47	365	3.1
1967–68	12.81	5.19	405	3.0
1968–69	12.05	3.80	315	4.1
1969–70	12.49	5.33	426	4.2
1970–71	12.91	8.03	622	4.0
1971–72	11.77	5.32	452	3.7
1972–73	11.82	3.93	333	4.5
1973–74	13.93	7.52	540	4.2
1974–75	11.29	3.27	290	5.5
1975–76	11.57	5.74	496	5.1
1976–77	10.75	5.85	544	4.9
1977–78	11.10	4.73	426	4.4
1978–79	11.39	5.57	489	4.4
1979–80	10.58	3.95	373	5.5
1980–81	11.66	5.34	458	5.5
1981–82	11.78	5.54	470	6.0
1982–83	10.94	5.13	469	6.0

(Contd.)

1983-84	11.83	7.72	653	4.8
1984-85	10.62	6.05	569	5.2
1985-86	10.65	3.66	344	5.1
1986-87	11.27	4.51	401	6.0
1987-88	8.71	3.30	378	8.4
1988-89	12.04	7.78	646	5.3
1989-90	10.90	6.65	610	6.3
1990-91	10.48	6.89	658	5.1
1991-92	10.03	4.67	465	6.5
1992-93	10.62	8.88	836	5.8
1993-94	9.55	4.97	521	6.6
1994-95	10.22	7.16	700	5.5
1995-96	9.32	5.38	577	6.2
1996-97	9.98	7.87	788	5.3
1997-98	9.67	7.64	791	5.9
1998-99	9.30	6.96	748	7.0
1999-00	8.90	5.78	650	8.3
2000-01	9.83	6.76	688	8.0
2001-02	9.53	8.28	869	6.3
2002-03	7.74	4.72	610	9.0
2003-04	10.61	12.11	1141	6.3
2004-05	9.23	7.93	859	NA
2005-06	9.58	7.68	802	NA

Note: The yield rates given above have been worked out on the basis of production and area figures taken in '000 units.

ANNEXURE-30

All-India Area, Production and Yield of Maize from 1950–51 to 2005–06 along with percentage Coverage under Irrigation

<i>Year</i>	<i>Area (m.ha)</i>	<i>Production (m.t)</i>	<i>Yield (kg./ha)</i>	<i>% Coverage under irrigation</i>
1950–51	3.16	1.73	547	11.4
1951–52	3.31	2.08	627	16.4
1952–53	3.61	2.87	796	14.0
1953–54	3.87	3.04	785	11.5
1954–55	3.75	2.98	794	14.6
1955–56	3.70	2.60	704	11.8
1956–57	3.76	3.08	819	13.1
1957–58	4.08	3.15	772	13.4
1958–59	4.27	3.46	812	10.5
1959–60	4.34	4.07	938	9.9
1960–61	4.41	4.08	926	12.6
1961–62	4.51	4.31	957	9.5
1962–63	4.64	4.61	992	11.5
1963–64	4.58	4.56	995	11.4
1964–65	4.62	4.66	1010	12.1
1965–66	4.80	4.82	1005	16.1
1966–67	5.07	4.89	964	15.6
1967–68	5.58	6.27	1123	11.9
1968–69	5.72	5.70	997	19.5
1969–70	5.86	5.67	968	18.2
1970–71	5.85	7.49	1279	15.9
1971–72	5.67	5.10	900	14.3
1972–73	5.84	6.39	1094	18.8
1973–74	6.02	5.80	965	14.7
1974–75	5.86	5.56	948	21.0
1975–76	6.03	7.26	1203	16.2
1976–77	6.00	6.36	1060	17.7
1977–78	5.68	5.97	1051	16.3
1978–79	5.76	6.20	1076	16.3
1979–80	5.72	5.60	979	24.0
1980–81	6.01	6.96	1159	20.1
1981–82	5.94	6.90	1162	19.8
1982–83	5.72	6.55	1145	21.7

(Contd.)

<i>Year</i>	<i>Area (m.ha)</i>	<i>Production (m.t)</i>	<i>Yield (kg./ha)</i>	<i>% Coverage under irrigation</i>
1983-84	5.86	7.92	1352	16.9
1984-85	5.80	8.44	1456	17.5
1985-86	5.80	6.64	1146	18.7
1986-87	5.92	7.59	1282	21.2
1987-88	5.56	5.72	1029	21.2
1988-89	5.90	8.23	1395	21.0
1989-90	5.92	9.65	1632	20.8
1990-91	5.90	8.96	1518	19.7
1991-92	5.86	8.06	1376	22.5
1992-93	5.96	9.99	1676	21.5
1993-94	6.00	9.60	1602	22.4
1994-95	6.14	8.88	1570	20.5
1995-96	5.98	9.53	1595	22.6
1996-97	6.26	10.77	1720	20.6
1997-98	6.32	10.82	1711	20.6
1998-99	6.20	11.15	1797	21.7
1999-00	6.42	11.51	1792	22.9
2000-01	6.61	12.04	1822	22.4
2001-02	6.58	13.16	2000	20.5
2002-03	6.64	11.15	1681	19.5
2003-04	7.34	14.98	2041	19.1
2004-05	7.43	14.17	1907	NA
2005-06	7.59	14.71	1938	NA

Note: The yield rates given above have been worked out on the basis of production and area figures taken in '000 units. NA-not available.

ANNEXURE-31

Area, Production and Yield of Maize during 2004–05 and 2005–06 in major Maize Growing States

Area–m.ha
Production–m.t
Yield–Kg./ha

State	2005–06						2004–05					
	Area	% of total area	Production	% of total production	Cumulative % of total production	Yield	Area	% of total area	Production	% of total production	Cumulative % of total production	Yield
Andhra Pradesh	0.76	10.01	3.09	21.01	21.01	4073	0.66	8.88	2.06	14.54	14.54	3142
Karnataka	0.94	12.38	2.73	18.56	39.56	2915	0.85	11.44	2.51	17.71	32.25	2955
Bihar	0.65	8.56	1.36	9.25	48.81	2098	0.61	8.21	1.47	10.37	42.63	2386
Madhya Pradesh	0.86	11.33	1.25	8.50	57.31	1450	0.90	12.11	1.25	8.82	51.45	1398
Rajasthan	1.00	13.18	1.10	7.48	64.79	1098	1.04	14.00	1.26	8.89	60.34	1211
Uttar Pradesh	0.81	10.67	1.05	7.14	71.92	1295	0.88	11.84	1.49	10.52	70.85	1705
Maharashtra	0.47	6.19	1.00	6.80	78.72	2106	0.43	5.79	0.75	5.29	76.15	1759
Gujarat	0.50	6.59	0.56	3.81	82.53	1124	0.46	6.19	0.41	2.89	79.04	898
Himachal Pradesh	0.30	3.95	0.54	3.67	86.20	1839	0.32	4.31	0.74	5.22	84.26	2272
Jammu & Kashmir	0.32	4.22	0.45	3.06	89.26	1413	0.32	4.31	0.49	3.46	87.72	1526
Punjab	0.15	1.98	0.40	2.72	91.98	2723	0.15	2.02	0.42	2.96	90.68	2740
Jharkhand	0.18	2.37	0.24	1.63	93.61	1315	0.19	2.56	0.29	2.05	92.73	1497
Tamil Nadu	0.20	2.64	0.24	1.63	95.24	1189	0.19	2.56	0.29	2.05	94.78	1552
West Bengal	0.05	0.66	0.13	0.88	96.13	2533	0.05	0.67	0.14	0.99	95.77	2977
Others	0.40	5.27	0.57	3.87	100.00	@	0.38	5.11	0.60	4.23	100.00	@
All India	7.59	100.00	14.71	100.00		1938	7.43	100.00	14.17	100.00		1907

@ - Since area/production is low in individual states, yield rate is not worked out.

Note: States have been arranged in descending order of percentage share of production during 2005–06.

* Provisional.

ANNEXURE-32

All-India Area, Production and Yield of total Pulses from 1950–51 to 2005–06 along with percentage Coverage under Irrigation

<i>Year</i>	<i>Area (m.ha)</i>	<i>Production (m.t)</i>	<i>Yield (kg./ha)</i>	<i>% Coverage under irrigation</i>
1950–51	19.09	8.41	441	9.4
1951–52	18.78	8.42	448	9.7
1952–53	19.84	9.19	463	9.8
1953–54	21.73	10.62	489	9.2
1954–55	21.91	10.95	500	8.8
1955–56	23.22	11.04	476	8.4
1956–57	23.32	11.55	495	7.3
1957–58	22.54	9.56	424	9.1
1958–59	24.31	13.15	541	8.4
1959–60	24.83	11.80	475	8.5
1960–61	23.56	12.70	539	8.0
1961–62	24.24	11.76	485	8.1
1962–63	24.27	11.53	475	8.9
1963–64	24.18	10.07	416	8.9
1964–65	23.88	12.42	520	9.2
1965–66	22.72	9.94	438	9.4
1966–67	22.12	8.35	377	10.9
1967–68	22.65	12.10	534	8.7
1968–69	21.26	10.42	490	9.8
1969–70	22.02	11.69	531	9.4
1970–71	22.54	11.82	524	8.8
1971–72	22.15	11.09	501	8.8
1972–73	20.92	9.91	474	8.1
1973–74	23.43	10.01	427	7.9
1974–75	22.03	10.02	455	8.1
1975–76	24.45	13.04	533	7.9
1976–77	22.98	11.36	494	7.5
1977–78	23.50	11.97	510	7.1
1978–79	23.66	12.18	515	7.9
1979–80	22.26	8.57	385	8.8
1980–81	22.46	10.63	473	9.0
1981–82	23.84	11.51	483	8.5
1982–83	22.83	11.86	519	8.2
1983–84	23.54	12.89	548	7.5

1984-85	22.74	11.96	526	7.9
1985-86	24.42	13.36	547	8.5
1986-87	23.16	11.71	506	9.6
1987-88	21.27	10.96	515	9.4
1988-89	23.15	13.85	598	9.3
1989-90	23.41	12.86	549	10.0
1990-91	24.66	14.26	578	10.5
1991-92	22.54	12.02	533	10.7
1992-93	22.36	12.82	573	10.4
1993-94	22.25	13.30	598	11.3
1994-95	23.03	14.04	610	12.7
1995-96	22.28	12.31	552	12.9
1996-97	22.45	14.24	635	12.7
1997-98	22.87	12.98	567	11.3
1998-99	23.50	14.91	634	12.1
1999-00	21.12	13.42	635	16.1
2000-01	20.35	11.08	544	12.5
2001-02	22.01	13.37	607	13.3
2002-03	20.50	11.13	543	14.4
2003-04	23.46	14.91	635	13.6
2004-05	22.76	13.13	577	NA
2005-06	22.39	13.39	598	NA

Note: The yield rates given above have been worked out on the basis of production and area figures taken in '000 units.
NA-not available.

ANNEXURE-33

Area, Production and Yield of total Pulses during 2004–05 and 2005–06 in major pulses growing states

Area–m.ha
Production–m.t
Yield–kg./ha

State	2005–06						2004–05					
	Area	% of total area	Production	% of total production	Cumulative % of total production	Yield	Area	% of total area	Production	% of total production	Cumulative % of total production	Yield
Madhya Pradesh	4.28	19.12	3.23	24.14	24.14	754	4.52	19.86	3.43	26.12	26.12	759
Uttar Pradesh	2.75	12.28	2.23	16.67	40.81	811	2.80	12.30	2.38	18.13	44.25	847
Maharashtra	3.43	15.32	2.01	15.02	55.83	584	3.38	14.85	1.66	12.64	56.89	492
Andhra Pradesh	1.78	7.95	1.38	10.31	66.14	772	1.80	7.91	1.02	7.77	64.66	565
Karnataka	1.98	8.84	0.96	7.17	73.32	487	2.11	9.27	0.79	6.02	70.68	376
Rajasthan	3.44	15.36	0.90	6.73	80.04	261	3.57	15.69	1.34	10.21	80.88	375
Gujarat	0.78	3.48	0.55	4.11	84.16	704	0.71	3.12	0.48	3.66	84.54	675
Bihar	0.60	2.68	0.45	3.36	87.52	749	0.66	2.90	0.47	3.58	88.12	710
Chhattisgarh	0.95	4.24	0.45	3.36	90.88	477	0.93	4.09	0.37	2.82	90.94	395
Orissa	0.81	3.62	0.34	2.54	93.42	416	0.64	2.81	0.25	1.90	92.84	388
Tamil Nadu	0.53	2.37	0.18	1.35	94.77	337	0.60	2.64	0.25	1.90	94.74	410
West Bengal	0.22	0.98	0.17	1.27	96.04	785	0.23	1.01	0.17	1.29	96.04	740
Jharkhand	0.29	1.30	0.17	1.27	97.31	592	0.27	1.19	0.16	1.22	97.26	586
Haryana	0.19	0.85	0.12	0.90	98.21	622	0.18	0.79	0.15	1.14	98.40	793
Others	0.36	1.61	0.24	1.79	100.00	@	0.36	1.58	0.21	1.60	100.00	@
All India	22.39	100.00	13.38	100.00		598	22.76	100.00	13.13	100.00		577

@ - Since area/production is low in individual states, yield rate is not worked out.

Note: States have been arranged in descending order of percentage share of production during 2005–06.

* Provisional.

ANNEXURE-34

All-India Area, Production and Yield of Groundnut from 1950–51 to 2005–06 along with percentage Coverage under Irrigation

<i>Year</i>	<i>Area (m.ha)</i>	<i>Production (m.t)</i>	<i>Yield (kg./ha)</i>	<i>% Coverage under irrigation</i>
1950–51	4.49	3.48	775	NA
1951–52	4.92	3.19	649	NA
1952–53	4.80	2.93	611	1.2
1953–54	4.25	3.45	811	1.5
1954–55	5.54	4.25	766	1.7
1955–56	5.13	3.86	752	1.7
1956–57	5.53	4.37	783	1.8
1957–58	6.42	4.71	734	2.9
1958–59	6.25	5.18	828	2.5
1959–60	6.44	4.56	708	2.5
1960–61	6.46	4.81	745	3.0
1961–62	6.89	4.99	725	3.4
1962–63	7.28	5.06	695	2.6
1963–64	6.89	5.30	769	3.0
1964–65	7.38	6.00	814	2.9
1965–66	7.70	4.26	554	3.4
1966–67	7.30	4.41	604	4.8
1967–68	7.55	5.73	759	5.4
1968–69	7.09	4.63	653	5.1
1969–70	7.13	5.13	720	5.8
1970–71	7.33	6.11	834	7.5
1971–72	7.51	6.18	823	7.3
1972–73	6.99	4.09	585	6.6
1973–74	7.02	5.93	845	9.1
1974–75	7.06	5.11	724	8.2
1975–76	7.22	6.76	935	6.9
1976–77	7.04	5.26	747	5.9
1977–78	7.03	6.09	866	8.1
1978–79	7.43	6.21	835	9.6
1979–80	7.17	5.77	805	12.1
1980–81	6.80	5.01	736	13.3
1981–82	7.43	7.22	972	14.2
1982–83	7.22	5.28	732	14.8

(Contd.)

<i>Year</i>	<i>Area (m.ha)</i>	<i>Production (m.t)</i>	<i>Yield (kg./ha)</i>	<i>% Coverage under irrigation</i>
1983-84	7.54	7.09	940	16.0
1984-85	7.17	6.44	898	16.1
1985-86	7.12	5.12	719	14.8
1986-87	6.98	5.88	841	15.1
1987-88	6.84	5.85	855	19.0
1988-89	8.53	9.66	1132	18.6
1989-90	8.71	8.10	930	17.0
1990-91	8.31	7.51	904	18.6
1991-92	8.67	7.09	818	19.1
1992-93	8.17	8.56	1049	19.7
1993-94	8.32	7.83	941	19.4
1994-95	7.85	8.06	1027	19.9
1995-96	7.52	7.58	1007	18.1
1996-97	7.60	8.64	1138	17.9
1997-98	7.09	7.37	1040	19.5
1998-99	7.40	8.98	1214	19.4
1999-00	6.87	5.26	766	19.0
2000-01	6.56	6.41	977	17.6
2001-02	6.24	7.03	1127	17.3
2002-03	5.94	4.12	694	16.5
2003-04	5.99	8.13	1357	16.6
2004-05	6.64	6.77	1020	NA
2005-06	6.74	7.99	1187	NA

Note: The yield rates given above have been worked out on the basis of production and area figures taken in '000 units.
NA-Not available.

ANNEXURE-35

Area, Production and Yield of Groundnut during 2004–05 and 2005–06 in major Groundnut Producing States

Area–m.ha
Production–m.t
Yield–kg./ha

State	2005–06						2004–05					
	Area	% of total area	Production	% of total production	Cumulative % of total production	Yield	Area	% of total area	Production	% of total production	Cumulative % of total production	Yield
Gujarat	1.95	28.93	3.39	42.43	42.43	1734	2.00	29.67	1.89	27.92	27.92	943
Andhra Pradesh	1.88	27.89	1.37	17.15	59.57	728	1.84	27.30	1.64	24.22	52.14	890
Tamil Nadu	0.62	9.20	1.10	13.77	73.34	1775	0.62	9.20	0.01	0.15	52.29	1632
Karnataka	1.04	15.43	0.67	8.39	81.73	645	0.97	14.39	0.74	10.93	63.22	766
Rajasthan	0.32	4.75	0.49	6.13	87.86	1549	0.29	4.30	0.45	6.65	69.87	1552
Maharashtra	0.43	6.38	0.41	5.13	92.99	958	0.45	6.68	0.50	7.39	77.25	1123
Madhya Pradesh	0.21	3.12	0.23	2.88	95.87	1126	0.20	2.97	0.24	3.55	80.80	1158
Orissa	0.09	1.34	0.11	1.38	97.25	1171	0.09	1.34	0.11	1.62	82.42	1233
Uttar Pradesh	0.11	1.63	0.09	1.13	98.37	851	0.08	1.19	0.07	1.03	83.46	816
Others	0.09	1.34	0.13	1.63	100.00	@	0.10	1.48	1.12	16.54	100.00	@
All India	6.74	100.00	7.99	100.00		1187	6.64	98.52	6.77	100.00		1020

@ - Since area/ production is low in individual states, yield rate is not worked out.

Note: States have been arranged in descending order of percentage share of production during 2005–06.

* Provisional.

ANNEXURE-36

All-India Area, Production and Yield of Rapeseed and Mustard from 1950–51 to 2005–06 along with percentage Coverage under Irrigation

<i>Year</i>	<i>Area (m.ha)</i>	<i>Production (m.t)</i>	<i>Yield (kg./ha)</i>	<i>% Coverage under irrigation</i>
1950–51	2.07	0.76	368	NA
1951–52	2.40	0.94	393	NA
1952–53	2.11	0.86	408	NA
1953–54	2.24	0.87	389	NA
1954–55	2.44	1.04	425	NA
1955–56	2.56	0.86	336	10.4
1956–57	2.54	1.04	411	13.5
1957–58	2.41	0.93	387	13.0
1958–59	2.45	1.04	426	13.0
1959–60	2.91	1.06	365	12.3
1960–61	2.88	1.35	467	12.1
1961–62	3.17	1.35	425	13.2
1962–63	3.13	1.30	417	13.3
1963–64	3.05	0.92	300	16.1
1964–65	2.91	1.47	507	15.2
1965–66	2.91	1.30	446	15.8
1966–67	3.01	1.23	408	20.3
1967–68	3.24	1.57	483	14.8
1968–69	2.87	1.35	469	18.4
1969–70	3.17	1.56	493	23.5
1970–71	3.32	1.98	594	25.2
1971–72	3.61	1.43	396	28.6
1972–73	3.32	1.81	545	26.7
1973–74	3.46	1.70	493	30.4
1974–75	3.68	2.25	612	35.4
1975–76	3.34	1.94	580	31.2
1976–77	3.13	1.55	496	34.4
1977–78	3.58	1.65	460	39.7
1978–79	3.54	1.86	525	39.7
1979–80	3.47	1.43	411	41.9
1980–81	4.11	2.30	560	43.7
1981–82	4.40	2.38	541	44.9
1982–83	3.83	2.21	577	44.0

(Contd.)

1983-84	3.87	2.61	673	46.6
1984-85	3.99	3.07	771	53.3
1985-86	3.98	2.68	674	51.3
1986-87	3.72	2.60	700	51.8
1987-88	4.62	3.45	748	54.7
1988-89	4.83	4.38	906	60.0
1989-90	4.97	4.13	831	61.6
1990-91	5.78	5.23	904	59.8
1991-92	6.55	5.86	895	63.9
1992-93	6.19	4.80	776	60.0
1993-94	6.29	5.33	847	59.4
1994-95	6.01	5.76	958	62.4
1995-96	6.55	6.00	916	65.8
1996-97	6.55	6.66	1017	69.1
1997-98	7.04	4.70	668	60.0
1998-99	6.51	5.66	869	58.3
1999-00	6.03	5.79	960	63.2
2000-01	4.48	4.19	935	66.1
2001-02	5.07	5.08	1002	68.3
2002-03	4.54	3.88	854	69.2
2003-04	5.43	6.29	1159	67.0
2004-05	7.32	7.59	1038	NA
2005-06	7.28	8.13	1117	NA

Note: The yield rates given above have been worked out on the basis of production and area figures taken in '000 units.
NA-Not available.

ANNEXURE-37

Area, Production and Yield of Rapeseed and Mustard during 2004–05 and 2005–06 in major Rapeseed and Mustard Producing States

State	2005–06						2004–05					
	Area	% of total area	Production	% of total production	Cumulative % of total production	Yield	Area	% of total area	Production	% of total production	Cumulative % of total production	Yield
Rajasthan	3.67	50.41	4.42	54.37	54.37	1205	3.68	50.55	3.97	52.31	52.31	1078
Uttar Pradesh	0.79	10.85	0.91	11.19	65.56	1149	0.82	11.26	0.80	10.54	62.85	979
Madhya Pradesh	0.81	11.13	0.85	10.46	76.01	1047	0.69	9.48	0.67	8.83	71.67	988
Haryana	0.71	9.75	0.79	9.72	85.73	1117	0.70	9.62	0.83	10.94	82.61	1177
Gujarat	0.34	4.67	0.46	5.66	91.39	1349	0.29	3.98	0.40	5.27	87.88	1390
West Bengal	0.42	5.77	0.38	4.67	96.06	909	0.46	6.32	0.43	5.67	93.54	934
Assam	0.21	2.88	0.10	1.23	97.29	456	0.24	3.30	0.13	1.71	95.26	528
Bihar	0.08	1.10	0.08	0.98	98.28	926	0.08	1.10	0.07	0.92	96.18	805
Punjab	0.05	0.69	0.05	0.62	98.89	1102	0.06	0.82	0.06	0.79	96.97	1033
Others	0.20	2.75	0.09	1.11	100.00	@	0.30	4.12	0.23	3.03	100.00	@
All India	7.28	100.00	8.13	100.00		1117	7.32	100.55	7.59	100.00		1038

@ - Since area/ production is low in individual states, yield rate is not worked out.

Note: States have been arranged in descending order of percentage share of production during 2005–06.

* Provisional.

ANNEXURE-38

All-India Area, Production and Yield of Soyabean from 1970-71 to 2005-06

<i>Year</i>	<i>Area (m.ha)</i>	<i>Production (m.t.)</i>	<i>Yield (kg./ha)</i>
1970-71	0.03	0.01	426
1971-72	0.03	0.01	426
1972-73	0.03	0.03	819
1973-74	0.05	0.04	829
1974-75	0.07	0.05	768
1975-76	0.09	0.09	975
1976-77	0.13	0.12	988
1977-78	0.20	0.18	940
1978-79	0.31	0.30	975
1979-80	0.50	0.28	568
1980-81	0.61	0.44	728
1981-82	0.48	0.35	741
1982-83	0.77	0.49	637
1983-84	0.84	0.61	735
1984-85	1.24	0.95	768
1985-86	1.34	1.02	764
1986-87	1.53	0.89	584
1987-88	1.54	0.90	582
1988-89	1.73	1.55	892
1989-90	2.25	1.81	801
1990-91	2.56	2.60	1015
1991-92	3.18	2.49	782
1992-93	3.79	3.39	894
1993-94	4.37	4.75	1086
1994-95	4.32	3.93	911
1995-96	5.04	5.10	1012
1996-97	5.45	5.38	987
1997-98	5.99	6.46	1079
1998-99	6.49	7.14	1100
1999-2000	6.22	7.08	1138
2000-01	6.42	5.28	822
2001-02	6.34	5.96	940
2002-03	6.11	4.65	762
2003-04	6.56	7.82	1193
2004-05	7.57	6.87	908
2005-06	7.71	8.27	1073

Note: The yield rates given above have been worked out on the basis of production and area figures taken in '000 units.

ANNEXURE-39

**Area, Production and Yield of Soyabean during 2004–05 and 2005–06
in major Soyabean Producing States**

State	2005–06						2004–05					
	Area	% of total area	Production	% of total production	Cumulative % of total production	Yield	Area	% of total area	Production	% of total production	Cumulative % of total production	Yield
Madhya Pradesh	4.26	55.25	4.50	54.41	54.41	1058	4.49	58.24	3.75	54.51	54.51	835
Maharashtra	2.35	30.48	2.53	30.59	85.01	1077	2.10	27.24	1.89	27.47	81.98	900
Rajasthan	0.74	9.60	0.86	10.40	95.41	1150	0.62	8.04	0.89	12.94	94.91	1425
Andhra Pradesh	0.10	1.30	0.19	2.30	97.70	1949	0.08	1.04	0.13	1.89	96.80	1567
Karnataka	0.13	1.69	0.07	0.85	98.55	534	0.16	2.08	0.09	1.31	98.11	604
Others	0.13	1.69	0.12	1.45	100.00	@	0.12	1.56	0.13	1.89	100.00	@
All India	7.71	100.00	8.27	100.00		1073	7.57	98.18	6.88	100.00		908

@ - Since area/ production is low in individual states, yield rate is not worked out.

Note: States have been arranged in descending order of percentage share of production during 2005–06.

* Provisional.

ANNEXURE-40

All-India Area, Production and Yield of Sunflower from 1970-71 to 2005-06

<i>Year</i>	<i>Area (m.ha)</i>	<i>Production (m.t.)</i>	<i>Yield (kg./ha)</i>
1970-71	0.12	0.08	653
1971-72	0.12	0.08	653
1972-73	0.12	0.08	653
1973-74	0.24	0.17	712
1974-75	0.34	0.23	671
1975-76	0.32	0.22	686
1976-77	0.26	0.14	541
1977-78	0.27	0.14	523
1978-79	0.18	0.10	543
1979-80	0.06	0.03	519
1980-81	0.12	0.07	555
1981-82	0.28	0.16	564
1982-83	0.46	0.23	497
1983-84	0.70	0.30	431
1984-85	0.84	0.44	527
1985-86	0.75	0.28	374
1986-87	1.02	0.42	411
1987-88	1.65	0.64	385
1988-89	1.10	0.37	335
1989-90	1.19	0.63	529
1990-91	1.63	0.87	535
1991-92	2.11	1.19	565
1992-93	2.09	1.18	567
1993-94	2.67	1.35	505
1994-95	2.00	1.22	610
1995-96	2.12	1.26	593
1996-97	1.93	1.25	646
1997-98	1.74	0.89	548
1998-99	1.82	0.94	517
1999-00	1.29	0.69	538
2000-01	1.07	0.65	602
2001-02	1.18	0.68	577
2002-03	1.64	0.87	531
2003-04	2.01	0.93	464
2004-05	2.17	1.19	549
2005-06	2.34	1.44	615

Note: The yield rates given above have been worked out on the basis of production and area figures taken in '000 units.

ANNEXURE-41

Area, Production and Yield of Sunflower during 2004–05 and 2005–06 in major Sunflower Producing States

State	2005–06						2004–05					
	Area	% of total area	Production	% of total production	Cumulative % of total production	Yield	Area	% of total area	Production	% of total production	Cumulative % of total production	Yield
Karnataka	1.43	61.11	0.79	54.86	54.86	552	1.27	54.27	0.60	50.42	50.42	471
Andhra Pradesh	0.44	18.80	0.30	20.83	75.69	671	0.48	20.51	0.29	24.37	74.79	609
Maharashtra	0.36	15.38	0.21	14.58	90.28	580	0.32	13.68	0.17	14.29	89.08	525
Bihar	0.02	0.85	0.03	2.08	92.36	1345	0.02	0.85	0.02	1.68	90.76	1401
Haryana	0.02	0.85	0.03	2.08	94.44	1667	0.01	0.43	0.01	0.84	91.60	1657
Tamil Nadu	0.02	0.85	0.02	1.39	95.83	1240	0.02	0.85	0.02	1.68	93.28	1060
Uttar Pradesh	0.01	0.47	0.02	1.39	97.22	1278	0.01	0.47	0.02	1.68	94.96	2049
Others	0.04	1.67	0.04	2.78	100.00	@	0.03	1.24	0.06	5.04	100.00	@
All India	2.34	100.00	1.44	100.00		615	2.16	92.31	1.19	100.00		549

@ - Since area/ production is low in individual states, yield rate is not worked out.

Note: States have been arranged in descending order of percentage share of production during 2005–06.

* Provisional.

ANNEXURE-42

**All-India Area, Production and Yield of Cotton from 1950–51 to 2005–06 along with
percentage Coverage under Irrigation**

<i>Year</i>	<i>Area (m.ha)</i>	<i>Production (m.t)</i>	<i>Yield (kg./ha)</i>	<i>% Coverage under irrigation</i>
1950–51	5.88	3.04	88	8.2
1951–52	6.56	3.28	85	9.1
1952–53	6.36	3.34	89	8.5
1953–54	6.99	4.13	100	8.4
1954–55	7.55	4.45	100	9.8
1955–56	8.09	4.18	88	10.0
1956–57	8.02	4.92	104	11.0
1957–58	8.01	4.96	105	12.7
1958–59	7.96	4.88	104	12.5
1959–60	7.30	3.68	86	12.9
1960–61	7.61	5.60	125	12.7
1961–62	7.98	4.85	103	13.0
1962–63	7.73	5.54	122	14.1
1963–64	8.22	5.75	119	15.3
1964–65	8.37	6.01	122	15.5
1965–66	7.96	4.85	104	15.9
1966–67	7.84	5.27	114	16.1
1967–68	8.00	5.78	123	16.7
1968–69	7.60	5.45	122	16.5
1969–70	7.73	5.56	122	16.4
1970–71	7.61	4.76	106	17.3
1971–72	7.80	6.95	151	20.3
1972–73	7.68	5.74	127	21.0
1973–74	7.57	6.31	142	22.1
1974–75	7.56	7.16	161	22.9
1975–76	7.35	5.95	138	23.5
1976–77	6.89	5.84	144	24.6
1977–78	7.87	7.24	157	26.2
1978–79	8.12	7.96	167	27.2
1979–80	8.13	7.65	160	27.5
1980–81	7.82	7.01	152	27.3
1981–82	8.06	7.88	166	27.7
1982–83	7.87	7.53	163	29.0

(Contd.)

<i>Year</i>	<i>Area (m.ha)</i>	<i>Production (m.t)</i>	<i>Yield (kg./ha)</i>	<i>% Coverage under irrigation</i>
1983-84	7.72	6.39	141	29.9
1984-85	7.38	8.51	196	28.5
1985-86	7.53	8.73	197	30.2
1986-87	6.95	6.91	169	31.1
1987-88	6.46	6.38	168	32.0
1988-89	7.34	8.74	202	33.0
1989-90	7.69	11.42	252	34.2
1990-91	7.44	9.84	225	32.9
1991-92	7.66	9.71	216	33.3
1992-93	7.54	11.40	257	34.6
1993-94	7.32	10.74	249	34.7
1994-95	7.87	11.89	257	34.2
1995-96	9.04	12.86	242	35.0
1996-97	9.12	14.23	265	35.8
1997-98	8.87	10.85	208	36.8
1998-99	9.34	12.29	224	34.9
1999-00	8.71	11.53	225	35.2
2000-01	8.53	9.52	190	34.3
2001-02	9.13	10.00	186	34.0
2002-03	7.67	8.62	191	33.1
2003-04	7.60	13.73	307	27.1
2004-05	8.79	16.43	318	NA
2005-06	8.68	18.50	362	NA

1 bale - 170 kg.

Note: The yield rates given above have been worked out on the basis of production and area figures taken in '000 units.

ANNEXURE-43

Area, Production and Yield of Cotton during 2004–05 and 2005–06 in major Cotton Producing States

Area–m.ha
Production–million bales (1 bale–170 kg.)
Yield–kg./ha

<i>State</i>	2005–06						2004–05					
	<i>Area</i>	<i>% of total area</i>	<i>Production</i>	<i>% of total production</i>	<i>Cumulative % of total production</i>	<i>Yield</i>	<i>Area</i>	<i>% of total area</i>	<i>Production</i>	<i>% of total production</i>	<i>Cumulative % of total production</i>	<i>Yield</i>
Gujarat	1.91	22.00	6.77	36.59	36.59	604	1.91	22.00	4.72	28.73	28.73	421
Maharashtra	2.88	33.18	3.16	17.08	53.68	187	2.84	32.72	2.94	17.89	46.62	176
Punjab	0.56	6.45	2.40	12.97	66.65	731	0.51	5.88	2.09	12.72	59.34	697
Andhra Pradesh	1.03	11.87	2.11	11.41	78.05	347	1.18	13.59	2.19	13.33	72.67	316
Haryana	0.58	6.68	1.50	8.11	86.16	437	0.62	7.14	2.08	12.66	85.33	568
Rajasthan	0.47	5.41	0.88	4.76	90.92	317	0.44	5.07	0.76	4.63	89.96	297
Madhya Pradesh	0.62	7.14	0.75	4.05	94.97	204	0.58	6.68	0.63	3.83	93.79	185
Karnataka	0.41	4.72	0.55	2.97	97.95	228	0.52	5.99	0.69	4.20	97.99	224
Tamil Nadu	0.14	1.61	0.21	1.14	99.08	258	0.13	1.50	0.19	1.16	99.15	256
Others	0.08	0.92	0.17	0.92	100.00	@	0.06	0.69	0.14	0.85	100.00	@
All India	8.68	100.00	18.50	100.00		362	8.79	101.27	16.43	100.00		318

@ - Since area/ production is low in individual states, yield rate is not worked out.

Note: States have been arranged in descending order of percentage share of production during 2005–06.

* Provisional.

ANNEXURE-44

All-India Area, Production and Yield of Jute and Mesta from 1950–51 to 2005–06

<i>Year</i>	<i>Area (m.ha)</i>	<i>Production (million bales)</i>	<i>Yield (kg./ha)</i>
1950–51	0.57	3.31	1043
1951–52	0.79	4.72	1074
1952–53	0.93	5.32	1028
1953–54	0.68	3.77	992
1954–55	0.68	3.86	1021
1955–56	0.94	5.39	1038
1956–57	1.07	5.81	977
1957–58	1.02	5.33	944
1958–59	1.10	6.91	1130
1959–60	0.98	5.69	1049
1960–61	0.90	5.26	1049
1961–62	1.34	8.24	1104
1962–63	1.24	7.19	1041
1963–64	1.27	7.98	1130
1964–65	1.21	7.66	1136
1965–66	1.11	5.78	936
1966–67	1.12	6.58	1058
1967–68	1.20	7.59	1137
1968–69	0.81	3.84	855
1969–70	1.09	6.79	1120
1970–71	1.08	6.19	1032
1971–72	1.11	6.84	1107
1972–73	0.99	6.09	1104
1973–74	1.16	7.68	1188
1974–75	0.98	5.83	1068
1975–76	0.91	5.91	1164
1976–77	1.09	7.10	1173
1977–78	1.16	7.15	1108
1978–79	1.27	8.33	1186
1979–80	1.22	7.96	1177
1980–81	1.30	8.16	1130
1981–82	1.15	8.37	1311
1982–83	1.02	7.17	1265
1983–84	1.05	7.72	1320

(Contd.)

1984-85	1.13	7.79	1242
1985-86	1.50	12.65	1524
1986-87	1.07	8.62	1454
1987-88	0.96	6.78	1274
1988-89	0.92	7.86	1540
1989-90	0.91	8.29	1646
1990-91	1.02	9.23	1634
1991-92	1.11	10.29	1662
1992-93	0.93	8.59	1658
1993-94	0.89	8.43	1713
1994-95	0.93	9.08	1760
1995-96	0.93	8.81	1712
1996-97	1.10	11.13	1818
1997-98	1.11	11.02	1792
1998-99	1.03	9.81	1722
1999-00	1.04	10.56	1836
2000-01	1.02	10.56	1867
2001-02	1.05	11.68	2007
2002-03	1.04	11.28	1960
2003-04	1.00	11.17	2008
2004-05	0.92	10.27	2019
2005-06	0.90	10.84	2173

1 bale-180 kg.

Note: The yield rates given above have been worked out on the basis of production and area figures taken in '000 units.

* Figures for 1950-51 and 1951-52 relate to Jute crop only.

ANNEXURE-45

**Area, Production and Yield of Jute and Mesta during 2004–05 and 2005–06 in respect
of major Jute and Mesta Producing States**

State	2005–06						2004–05					
	Area	% of total area	Production	% of total production	Cumulative % of total production	Yield	Area	% of total area	Production	% of total production	Cumulative % of total production	Yield
West Bengal	0.57	63.33	8.11	74.82	74.82	2566	0.58	64.44	7.93	77.22	77.22	2473
Bihar	0.15	16.67	1.39	12.82	87.64	1692	0.15	16.67	1.18	11.49	88.70	1416
Andhra Pradesh	0.05	5.56	0.46	4.24	91.88	1638	0.05	5.56	0.46	4.48	93.18	1555
Assam	0.06	6.67	0.60	5.54	97.42	1733	0.06	6.67	0.44	4.28	97.47	1243
Orissa	0.03	3.60	0.14	1.29	98.71	991	0.03	3.60	0.15	1.46	98.93	872
Maharashtra	0.02	2.22	0.04	0.37	99.08	270	0.02	2.22	0.04	0.39	99.32	265
Meghalaya	0.08	8.89	0.06	0.55	99.63	1194	0.08	8.89	0.04	0.39	99.71	860
Others	-0.06	-6.93	0.04	0.37	100.00	@	-0.05	-5.82	0.03	0.29	100.00	@
All India	0.90	100.00	10.84	100.00		2173	0.92	102.22	10.27	100.00		2019

@ - Since area/ production is low in individual states, yield rate is not worked out.

Note: States have been arranged in descending order of percentage share of production during 2005–06.

* Provisional.

ANNEXURE-46

All-India Area, Production and Yield of Sugarcane from 1950–51 to 2005–06 along with percentage Coverage under Irrigation

<i>Year</i>	<i>Area (m.ha)</i>	<i>Production (m.t)</i>	<i>Yield (kg./ha)</i>	<i>% Coverage under irrigation</i>
1950–51	1.71	57.05	33422	67.3
1951–52	1.94	61.63	31786	68.8
1952–53	1.73	51.00	29495	66.3
1953–54	1.41	44.41	31497	67.7
1954–55	1.62	58.74	36303	68.8
1955–56	1.85	60.54	32779	67.2
1956–57	2.05	69.05	33683	64.9
1957–58	2.07	71.16	34325	65.2
1958–59	1.95	73.36	37658	67.4
1959–60	2.14	77.82	36414	67.9
1960–61	2.42	110.00	45549	69.3
1961–62	2.46	103.97	42349	68.0
1962–63	2.24	91.91	40996	67.8
1963–64	2.25	104.23	46353	69.6
1964–65	2.60	121.91	46838	71.5
1965–66	2.84	123.99	43717	71.1
1966–67	2.30	92.83	40336	71.0
1967–68	2.05	95.50	40665	74.1
1968–69	2.53	124.68	49236	76.9
1969–70	2.75	135.02	49121	75.5
1970–71	2.62	126.37	48322	72.4
1971–72	2.39	113.57	47511	71.8
1972–73	2.45	124.87	50933	75.0
1973–74	2.75	140.81	51163	76.5
1974–75	2.89	144.29	49855	77.9
1975–76	2.76	140.60	50903	78.0
1976–77	2.87	153.01	53383	77.2
1977–78	3.15	176.97	56160	78.1
1978–79	3.09	151.66	49114	77.8
1979–80	2.61	128.83	49358	77.2
1980–81	2.67	154.25	57844	81.2
1981–82	3.19	186.36	58359	82.3
1982–83	3.36	189.51	56441	80.5

(Contd.)

<i>Year</i>	<i>Area (m.ha)</i>	<i>Production (m.t)</i>	<i>Yield (kg./ha)</i>	<i>% Coverage under irrigation</i>
1983-84	3.11	174.08	55978	80.3
1984-85	2.95	170.32	57673	83.6
1985-86	2.85	170.65	59889	84.5
1986-87	3.08	186.09	60444	85.4
1987-88	3.28	196.74	60006	85.6
1988-89	3.33	203.04	60992	86.2
1989-90	3.44	225.57	65612	86.9
1990-91	3.69	241.05	65395	86.9
1991-92	3.84	254.00	66069	88.0
1992-93	3.57	228.03	63843	88.3
1993-94	3.42	229.66	67120	88.8
1994-95	3.87	275.54	71254	87.9
1995-96	4.15	281.10	67787	87.4
1996-97	4.17	277.56	66496	88.1
1997-98	3.93	279.54	71134	91.3
1998-99	4.05	288.72	71203	91.7
1999-2000	4.22	299.32	70935	92.0
2000-01	4.32	295.96	68577	92.1
2001-02	4.41	297.21	67370	91.6
2002-03	4.52	287.38	63576	91.3
2003-04	3.93	233.86	59380	90.7
2004-05	3.66	237.08	64752	NA
2005-06	4.20	281.17	66928	NA

Note: The yield rates given above have been worked out on the basis of production and area figures taken in '000 units.
NA - Not available.

ANNEXURE-47

**Area, Production and Yield of Sugarcane during 2004–05 and 2005–06
in major Sugarcane Producing States**

Area-m.ha
Production-(m.t.)
Yield-kg./ha

State	2005–06						2004–05					
	Area	% of total area	Production	% of total production	Cumulative % of total production	Yield	Area	% of total area	Production	% of total production	Cumulative % of total production	Yield
Uttar Pradesh	2.16	51.43	125.47	44.62	44.62	58201	1.95	53.28	118.72	50.08	50.08	60733
Maharashtra	0.50	11.90	38.85	13.82	58.44	77551	0.32	8.74	20.48	8.64	58.71	63194
Tamil Nadu	0.34	8.10	35.11	12.49	70.93	104671	0.23	6.28	23.40	9.87	68.58	100845
Karnataka	0.22	5.24	18.27	6.50	77.43	83411	0.17	4.64	14.28	6.02	74.61	80202
Andhra Pradesh	0.23	5.48	17.66	6.28	83.71	76765	0.21	5.74	15.74	6.64	81.25	74948
Gujarat	0.20	4.76	14.58	5.19	88.89	74010	0.20	5.46	14.57	6.15	87.39	74072
Haryana	0.13	3.10	8.18	2.91	91.80	64409	0.13	3.55	8.06	3.40	90.79	62000
Uttaranchal	0.10	2.38	6.13	2.18	93.98	60733	0.11	3.01	6.44	2.72	93.51	60196
Punjab	0.08	1.90	4.86	1.73	95.71	57857	0.09	2.46	5.17	2.18	95.69	60116
Bihar	0.10	2.38	4.34	1.54	97.25	42822	0.10	2.73	4.11	1.73	97.42	39460
Madhya Pradesh	0.06	1.43	2.43	0.86	98.12	43694	0.05	1.37	2.15	0.91	98.33	40914
West Bengal	0.02	0.48	1.25	0.44	98.56	83180	0.02	0.55	1.03	0.43	98.76	66231
Orissa	0.02	0.48	1.07	0.38	98.94	65828	0.02	0.55	0.86	0.36	99.13	55838
Assam	0.02	0.48	0.87	0.31	99.25	37231	0.02	0.55	0.88	0.37	99.50	36983
Others	0.02	0.48	2.10	0.75	100.00	@	0.04	1.09	1.19	0.50	100.00	@
All India	4.20	100.00	281.17	100.00		66928	3.66	100.00	237.08	100.00		64752

@ - Since area/ production is low in individual states, yield rate is not worked out.

Note: States have been arranged in descending order of percentage share of production during 2005–06.

* Provisional.

**This page
intentionally left
blank**

Acronyms

A

AAU	Assam Agricultural University (India)
ABA	Absciscic acid analogue
AB-DLO	Research Institute for Agrobiolgy and Soil Fertility (The Netherlands)
ADB	Asian Development Bank (Headquarters: Philippines)
ADC	Agricultural Development Council (formerly CECA) (New York, USA)
AEZ	Agroecological Zone
AGDP	Agricultural Gross Domestic Products
AGLINET	Agricultural Libraries Network
AGRICOLA	Agricultural On-line Access (Headquarters: USA)
AGRIS	International Information System for the Agricultural Sciences and Technology (affiliated with FAO, Italy)
ai	Active ingredient
AIBA	Agriculture Information Bank for Asia (Headquarters: Philippines)
AICARP	All India Coordinated Agronomic Research Project
AICORP	All India Coordinated Oilseeds Research Project
AICRIP	All India Coordinated Rice Improvement Project
AICSMSP	All India Coordinated Scheme of Micronutrients in Soils and Plants
AIEDP	Asian Institute for Economic Development and Planning (Headquarters: Thailand)
AIFST	Australian Institute of Food Science and Technology
AIRD	Asian Institute for Rural Development (Headquarters: India)
Amax	Maximum photosynthetic rate
APAU	Andhra Pradesh Agricultural University (India)
APCFFT	Asian and Pacific Council Food and Fertilizer Technology Center
APEID	Asian Programme of Educational Innovation for Development (Headquarters: Thailand)
ARA	Acetylene-reducing activity
ARBN	Asian Rice Biotechnology Network OR African Rice Blast Nursery
ARC	Agricultural Resources Centre OR Agricultural Research Council OR Agricultural Research Centre

AREEO	Agricultural Research, Education, Extension Organization (Iran)
ARFSN	Asian Rice Farming Systems Network (IRRI)
ARS/USDA	Agricultural Research Service/United States Department of Agriculture
ARTP	African Rice Testing Program
ASA	American Society of Agronomy
ASEAN	Association of South-East Asian Nations
asl	Above sea level
ASS	Acid sulfate soils
ASPP	American Society of Plant Physiology
ASTA	American Seed Trade Association
ATP	Adenosine triphosphate
AVRDC	Asian Vegetable Research and Development Center (Taiwan)
AYT	Advanced yield trial
B	
BARC	Bhabha Atomic Research Institute or Bangladesh Agricultural Research Council
BARI	Bihar Agricultural Research Institute (India) or Bangladesh Agricultural Research Institute
BARR	Board on Agriculture and Renewable Resources (Washington, DC)
BAU	Bangladesh Agricultural University or Birsa Agricultural University (India)
BC	Backcross
B:C	Benefit-to-cost ratio
BGA	Blue-green algae
BIFAD	Board for International Food and Agricultural Development (Agency for International Development, Washington, DC)
BIOSIS	Bioscience Information Service of Biological Abstracts (USA)
BIOTECH	National Institute of Biotechnology and Applied Microbiology (Philippines)
BNF	Biological nitrogen fixation
BOSTID	Board on Science and Technology for International Development (Washington, DC)
BPH	Brown plant hopper
BRI	Bangladesh Rice Research Institute
BShR	Brown sheath rot
Bt	Bacillus thuringiensis
C	
CABI	Centre for Agriculture and Biosciences International (UK)
CARD	Center for Agricultural Research and Development (Iowa, USA) OR Communicators for Agricultural and Rural Development (Philippines) OR Center for Agricultural Research and Development (Bhutan)
CARDI	Caribbean Agricultural Research and Development Institute (Trinidad)
CARI	Central Agricultural Research Institute (Sri Lanka)
CARIS	Current Agricultural Research Information Systems (FAO)
CAZRI	Central Arid Zone Research Institute (India)

CEC	Cation exchange capacity OR Continuing Education Center, Philippines
CEDA	Centre for Economic Development and Administration (Nepal)
CEDO	Centre for Educational Development Overseas (UK)
CERES	Crop estimation through resource and environment synthesis
CERI	Centre for Educational Research and Innovation (OEEC, France)
CFTRI	Central Food Technological Research Institute (India)
CFTU/CIIFAD	Conservation Farming in the Tropical Uplands/Cornell International Institute for Food, Agriculture, and Development (USA)
CGFPI	Consultative Group on Food Production and Investment in Developing Countries (United Nations, affiliated with IBRD)
CGIAR	Consultative Group on International Agricultural Research (Headquarters: Washington, DC)
CGR	Crop growth rate
CH₄	Methane
CHO	Carbohydrates
CIAE	Central Institute of Agricultural Engineering (India)
CIBC	Commonwealth Institute of Biological Control (Trinidad)
CIDA	Canadian International Development Agency
CIEI	Center for International Environment Information (New York, USA)
CIIFAD	Cornell International Institute for Food, Agriculture, and Development (New York, USA)
CIRAD	Center for International Cooperation in Development-oriented Agricultural Research, France
CMA/IIM	Centre for Management in Agriculture/Indian Institute of Management
C:N	Carbon-to-nitrogen ratio
CODATA	Committee on Data for Science and Technology (ICSU, France)
COSTED	Committee on Science and Technology in Developing Countries (ICSU, France)
CREMNET	Crop Resources Management Network (IRRI)
CRIFC	Central Research Institute for Food Crops (Indonesia)
CRRI	Central Rice Research Institute (India)
CSIR	Council for Scientific and Industrial Research (Ghana, India, New Zealand)
CSIRO	Commonwealth Scientific and Industrial Research Organization (Australia)
CSN	Cropping Systems Network
CSRRI	Central Soil Salinity Research Institute (India)
CSTD	United Nations Center for Science and Technology for Development (USA)
D	
DAE	Days after emergence
DAF	Days after flowering OR DNA Amplification Fingerprinting
DAH	Days After Harvest
DAI	Days After Inoculation
DANIDA	Danish International Development Agency (Copenhagen)
DAP	Days After Planting
DARE	Department of Agricultural Research and Education (India)

DAS	Days after seeding/sowing
DAS-ELISA	Double Antibody Sandwich Enzyme-linked Immunosorbent Assay
DAT	Days after treatment OR Days after transplanting
DBH	Days before Harvest/Heading
DBMS	Data base Management System
DBT	Days before Transplanting
DM	Dry Matter
DMI	Dry Matter Intake
DMP	Dry Matter Production
DMRT	Duncan's Multiple Range Test
DOA & E	Department of Agriculture and Extension
DOASL	Department of Agriculture, Sri Lanka
DOST	Department of Science and Technology (Philippines)
DOT	Date of transplanting
DRAAE	Department of Agronomic Research and Agro-economy, FOFIFA, Madagascar
DRR	Department of Rice Research, FOFIFA, Madagascar OR Directorate of Rice Research (India)
DSR	Direct seeded rice
DSS	Decision support system
DSSAT	Decision Support System for Agro Technology Transfer
dw	Dry weight
DWR	Deepwater Rice
DWS	Direct Wet Seedbed

F

F1	First filial generation
F2	Second filial generation
Fn	nth filial generation
FA	Fulvic acid
FAO	Food and Agriculture Organization (UN)
fb	Followed by
FIDA	International Fund for Agricultural Development (France)
FNRI	Food and Nutrition Research Institute (Philippines)
FSR	Farming System Research
FSRI	Farming Systems Research Institute (Thailand)
FSSRI	Farming Systems and Soil Resources Institute (UPLB, Philippines)
fw	Fresh weight
FYM	Farmyard manure

H

ha	Hectare
HA	Humic Acid
HAU	Haryana Agricultural University (India)
HDI	High density index

HI	Harvest index
HPLC	High performance liquid chromatography
HRD	Human resources development
HW	Hand Weeding
HWT	Hot Water Treatment
I	
IAA	Indole acetic acid
IAAE	International Association of Agricultural Economics (Headquarters: UK)
IAAP	Intensive Agricultural Area Program (India)
IADP	Intensive Agricultural District Program (India)
IARI	Indian Agricultural Research Institute
IAS	Institute of Agricultural Sciences (Republic of Korea)
IASRI	Indian Agricultural Statistics Research Institute
IBPGR	International Board for Plant Genetic Resources (Italy; became IPGRI in 1994)
ICAR	Indian Council of Agricultural Research
ICARDA	International Centre for Agricultural Research in the Dry Areas (Syria)
ICASALS	International Center for Arid and Semi-Arid Land Studies (Texas, USA)
ICID	International Commission on Irrigation and Drainage (India)
ICRISAT	International Crops Research Institute for the Semi-Arid Tropics (India)
IDRC	International Development Research Centre (Canada)
IEA	Initial Environmental Assessment
IFAD	International Fund for Agricultural Development (Italy)
IFDC	International Fertilizer Development Center (Alabama, USA)
IFDP	Institute for Food Development Policy (USA)
IFPRI	International Food Policy and Research Institute (Washington, DC)
IFRPD	Institute of Food Research and Product Development (Thailand)
IFS	International Foundation of Science (Sweden)
IGLIC	International Grain Legume Information Centre (Nigeria)
IGUAT	Indira Gandhi University of Agriculture and Technology (India)
IIBC	International Institute of Biological Control (UK)
IIHR	Indian Institute for Horticultural Research
IMI	International Irrigation Management Institute (Sri Lanka)
IITA	International Institute of Tropical Agriculture (Nigeria)
ILO	International Labour Organization
ILRI	International Institute for Land Reclamation and Improvement (The Netherlands) or International Livestock Research Institute (Kenya and Ethiopia)
INSA	Indian National Science Academy or National Institute of Agricultural Sciences (Vietnam)
INSFFER	International Network on Soil Fertility and Fertilizer Evaluation for Rice
INSURF	International Network on Soil Fertility and Sustainable Rice Farming
IPGRI	International Plant Genetic Resources Institute (formerly IBPGR)
IPM	Integrated Pest Management
IPPC	International Plant Protection Center (Oregon, USA)

IPR	Intellectual property rights
IR	Infrared spectrophotometry or Irrigated rice
IRAT	Institute for Research in Tropical Agriculture, France
IRRI	International Rice Research Institute (Philippines)
IRRN	International Rice Research Notes (formerly IRRI Newsletter)
IRPT	International Rice Testing Program (now INGER)
ISBN	International standard book number
ISFEIP	International Soil Fertility Evaluation and Improvement Program
ISMARC	Irrigation System Management Research Committee
ISNAR	International Service for National Agricultural Research (The Netherlands)
ISO	International Standardization Organization
ISRIC	International Soil Reference and Information Centre (includes the former International Soil Museum, The Netherlands)
ISSN	International standard serial number
ISSS	International Soil Science Society (Italy)
ISTA	International Seed Testing Association (Switzerland)
IUCN	International Union for the Conservation of Nature and Natural Resources (Switzerland)
IVOMD	<i>In vitro</i> Organic Matter Digestibility
IVTDM	<i>In vitro</i> Total Dry Matter Digestibility
L	
L/B	Length/Breadth ratio of grain
LAI	Leaf Area Index
LAN	Local Area Network
LAR	Leaf Area Ratio
LC50	Concentration that causes 50% Mortality
LD50	Duration, in days, to 50% Mortality
LEISA	Low external input and sustainable Agriculture
LER	Land Equivalent Ratio
LRDC	Land Resources Development Centre (UK)
LSD	Least Significant Difference
LTCCE	Long-term Continuous Cropping Experiment
LTFE	Long-term Fertility Experiment
LTR	Light Transmission Ratio
LUCC	Land-use/Cover Change
LWD	Leaf Water Potential
M	
MACROS	Modules for Annual Crop Simulation
MARDI	Malaysian Agricultural Research and Development Institute
m-d	Man-days
MP	Matric Potential
MS	Male Sterile or Mildly susceptible or Moderately susceptible

MOA Ministry of Agriculture
MW Molecular weight

N

NARC Nepal Agricultural Research Council or National Agricultural Research Center (Japan)
NARP National Agricultural Research Project (India)
NARS/s National Agricultural Research System/s
NAS National Academy of Sciences (Washington, DC)
NBPGR National Bureau of Plant Genetic Resources (India)
NCRI National Cereals Research Institute (Nigeria)
NDUAT Narendra Deva University of Agriculture and Technology (India)
NERC National Environment Research Center (Alabama, USA)
NFDC National Fertilizer Development Center (Tennessee, USA)
NFE Nitrogen-free extract
NFNC National Food and Nutrition Commission (Zambia)
NFS Nitrogen fixation stimulation
NFTAL Nitrogen fixation in tropical agricultural legumes
NGO Nongovernmental Organization
NHI Nitrogen harvest index
NIAR National Institute of Agrobiological Resources (Japan)
NIB National Irrigation Board (Philippines)
NIR Near-infrared reflectance
NIRD National Institute for Rural Development (India)
NIRS National Irrigation Research Station (Zambia)
NMR Nuclear magnetic resonance spectroscopy
NoET Number of effective tillers/hill
NoFG Number of filled grains/panicle
NPGRCC National Plant Genetic Resources Conservation Center (China)
NPGRLL National Plant Genetic Resources Laboratory (Philippines)
NPT New plant type
NRI Natural Research Institute (UK)
NRIP National Rice Improvement Programme (Nepal)
NSERC National Sciences and Engineering Research Council of Canada (Ottawa)
NSKE Neem seed kernel extract
NUE Nitrogen use efficiency

O

ODAI Operation for Integrated Agricultural Development
ODC Overseas Development Council (USA)
OM Organic matter
ORP Operational Research Project (India)
OUAT Orissa University of Agriculture and Technology (India)
OYT Observational yield trial/test

P

PAR	Photo Synthetically Active Radiation
PARC	Pakistan Agricultural Research Council
PAU	Punjab Agricultural University (India)
Pd	Domestic price
PDSS	Phosphorus Decision Support System
PEt	Potential Evapotranspiration
PFP	Partial Factor Productivity
PGMS	Photosensitive Genetic Male Sterile/Sterility
PGR	Plant Growth Regulator
PhilRice	Philippine Rice Research Institute
PHT	Post Harvest Technology
PHTRC	Post Harvest Horticulture Training and Research Center (Philippines)
PI	Panicle Initiation
PNUE	Photosynthetic N use efficiency
PPD	Plant Population Density
PRA	Participatory Rural Appraisal
PU	Prilled Urea
PVC	Polyvinyl Chloride
Pw	World Price
PWD	Ponding Water Depth

R

R	Resistant or Restorer or Restorer line
RAU	Rajendra Agricultural University (India)
RAVC	Return After Variable Cost
RCI	Rice Cropping Intensity
rDNA	Recombinant DNA
RG	Rate of Germination
RGR	Relative Growth Rate
RGSV	Rice Grassy Stunt Virus
RH	Relative Humidity
RIFSA	Research Institute for Food Crops in Swampy Areas (Indonesia)
RKN	Root Knot Nematode
RLR	Rainfed Lowland Rice
RNA	Ribonucleic Acid
RPM	Revolutions per Minute
rRNA	Ribosomal Ribonucleic Acid
RRSV	Rice Ragged Stunt Virus
RRTC	Rice Research and Training Centre (Egypt)
RS	Remote Sensing or Row seeder or Simple random sampling
RSV	Ragged Stunt Virus
RTD	Rice Tungro Disease
RTV	Rice Tungro Virus

S

SAARC	South Asian Association for Regional Cooperation
SACCAR	Southern African Centre for Cooperation in Agricultural Research and Training (Headquarters: Botswana)
SADC	Southern African Development Coordination Conference (Headquarters: Botswana)
SAREC	Swedish Agency for Research Cooperation with Developing Countries
SARP	Systems Analysis and Simulation for Rice Production
SCOPE	Scientific Committee on Problems of the Environment (ICSU, France)
SCU	Sulfur-Coated Urea
SEAPPO	South-east Asia and Pacific Plant Protection Organization
SEARCA	South-east Asian Regional Center for Graduate Study and Research in Agriculture (Headquarters: Philippines)
SLW	Specific Leaf Weight
SMB	Soil Microbial Biomass
SMT	Soil Moisture Tension
SOC	Soil Organic Carbon
SOM	Soil Organic Matter
SPAD	Soil and Plant Analyzer Development (Japan)
SUB	Submergence
SWRI	Surface Water Retention Index

T

t	ton/s
T	Temperature or Tertiary tillers
TAC	Technical Advisory Committee (CGIAR)
TARC	Tropical Agriculture Research Center (now JIRCAS, Japan)
TARI	Taiwan Agricultural Research Institute
TARO	Tanzania Agricultural Research Institute
TDMY	Total Dry Matter Yield
TDRI	Thailand Development Research Institute or Tropical Development and Research Institute (formerly Tropical Products Institute, UK)
TFP	Total factor productivity
TNAU	Tamil Nadu Agricultural University (India)
TNAU-WTC	Tamil Nadu Agricultural University, Water Technology Center (India)
TNRRI	Tamil Nadu Rice Research Institute (India)
TPR	Transplanted rice
TPRI	Tropical Pesticides Research Institute (Tanzania)
TSP	Triple Super Phosphate
TUAT	Tokyo University of Agricultural Technology
TVC	Total Variable Cost

U

UAS	University of Agricultural Sciences (India)
UES	Urea-elemental Sulfur
UNCED	United Nations Conference on Environment and Development
UNDP/WB	United Nations Development Programme/World Bank
UNESCO	United Nations Educational, Scientific, and Cultural Organization (France)
URICC	Upland Rice Research Intercenter Coordinating Committee
USAID	United States Agency for International Development (also AID)
USDA	United States Department of Agriculture
USEPA	United States Environmental Protection Agency
USG	Urea Supergranule
UV	Ultraviolet Light

W

WAI	Weeks after incubation or Weeks after inoculation
WARDA	West Africa Rice Development Association (Côte d'Ivoire)
WAS	Weeks After Seeding
WAU	Wageningen Agricultural University (The Netherlands)
WCRP	World Climate Research Programme
WHO	World Health Organization
WMO	World Meteorological Organization
WS	Wet season
wt	Weight
WTD	Water Table Depth
WUE	Water Use Efficiency

Glossary

The glossary given in this part, contain the following list in alphabetic order. For a more complete glossary and acronyms, we recommend the readers to refer the books like Agriculture : Facts and Figures (Subbaian, Annadurai and Palaniappan, 2000–published by Scientific Publishers, Jodhpur, India), Agronomic terminology (by Indian Society of Agronomy, New Delhi) and Glossary of terms in crop production (by Ramamoorthy, Annadurai and Subbaian, 2005 published by Scientific Publishers, Jodhpur, India, 420p). For few important words, the glossary of terms is given then and there.

Absolute humidity: The actual mass of water vapour present in a given volume of moist air. It is expressed as grams of water vapour per cubic meter or cubic feet.

Absolute water requirement: Also called consumptive use of water. This is the quantity of water in ha-cm per crop season absorbed by the crop together with the evaporation from the crop producing land. It includes the water used by evapo-transpiration and retained in the plant body.

Absorption: The process by which a substance is taken into and included within another substance, *i.e.*, intake of water by soil, or intake of gases, water, nutrients, or other substances by plants.

Absorptivity: Absorptivity of a substance is defined as the ratio of the amount of radiant energy absorbed to the total amount incident upon that substance. The absorptivity of a blackbody is unity. Natural bodies like sun and earth are near perfect black bodies

Acre-Foot: A volume of water required to irrigate an area of one acre to a depth of one foot. This is equal to 43,560 c. ft or 1233.5 m³.

Acre-Inch: A volume of water necessary to cover an area of one acre of land to a depth of one inch. The volume of this water is 3630 cubic feet (102.8 m³). 1 cubic feet = 0.0283 m³ = 28.32 litres.

Actual crop evapo-transpiration: Rate of evapo-transpiration equal to or smaller than PET as affected by the level of available soil water salinity field, size, or other causes; mm/day.

Actual vapour pressure: Pressure exerted by water vapour contained in the air, millibar (mb) or mm of Hg.

Adsorption: The increased concentration of molecules or ions at a surface, including exchangeable cations and anions on soil particles.

Advection: The process of transport of an atmospheric property (such as heat, water vapour or momentum) solely by the horizontal motions of the atmosphere.

Aerodynamic: Refers to forces of moving air acting upon the soil of crop surface.

Aggregate: A single mass or cluster of soil consisting of many soil particles held together, such as a clod, prism, crumb, or granule.

Agriculture Labourer: Basically they own neither land nor farm implements although some may own to a negligible extent. They make a living mainly or wholly by selling their labour in agriculture of allied activities as free or attached or share-cropper for a very low wage in without much security of tenure.

Agro climatic regions: The grouping of different physical areas within the country into broadly homogeneous zones based on climatic and edaphic factors.

Air capacity: The quantity of air in the soil when the soil is at field moisture capacity.

Albedo: It is the capacity of any surface to reflect the incoming radiation (light) or it is the ratio of incoming radiation to the outgoing radiation. The total reflectivity is known as earth's albedo. Average albedo value for earth is 34%. The total energy coming to the earth over a considerable period of time is equal to the total outward losses. If this were not so, the earth would seem become either very hot or very cold. Actually there is a deficit of heat at higher latitudes and surplus in low latitudes.

Alkali soil: A soil that contains sufficient exchangeable sodium to interfere with the growth of most crop plants, either with or without appreciable quantities of soluble salts.

Alkaline soil: A soil that has an alkaline reaction, *i.e.*, a soil for which the pH reading of the saturated soil paste is higher than 7.

Anticyclone: When isobars are circular, elliptical in shape and the pressure is highest at the centre such a pressure system is called 'High' or 'Anticyclone'. When the isobars are elliptical rather than circular the system is called as 'Ridge' or 'Wedge'. The movement will be clockwise in the Northern hemisphere while it is anti-clockwise in the southern hemisphere.

Aquifer: Water bearing formation in the ground that will yield enough water.

Arid: A climate that is characterized by low rainfall and high rate of evaporation. Arid climate is usually defined as less than 10 inches (25 cm) of precipitation per year, and semi-arid as between 10 and 20 inches per year.

Atmospheric pressure: The pressure exerted by the atmosphere as a consequence of the weight of the air lying directly above the unit of area in question. At sea level atmospheric pressure is equal to 76 cm Hg column.

Available soil water: Depth of water stored in the root zone between field capacity and PWP; mm/m soil depth.

Blackbody radiation: A Blackbody is defined as a body, which completely absorbs all the heat radiations falling on it without reflecting and transmitting any of it. It means reflectivity and transmittivity become zero. When such a black body is heated, it emits radiation of all wavelengths depending upon its temp.

Blue colour of the sky: If the circumference of the scattering particle is less than about 1/10 of the wavelength of the incident radiation, the scattering co-efficient is inversely proportional to the fourth power of the wavelength of the incident radiation. This is known as **Rayleigh scattering**. This is the primary cause of the blue colour of the sky. For larger particles with circumference >30 times of wavelength of the incident radiation, scattering is independent of the wavelength (*i.e.*) white light is scattered. This is known as **Mei scaring**.

Bowen ratio: The ratio of energy fluxes upward as sensible heat to latent energy flux in the same direction (negative when the fluxes are in opposite directions).

Buoyancy: The upward force exerted on a volume of fluid (or an object in the fluid) by virtue of density difference between the volume of fluid (or the object) and that of the surrounding fluid.

Calorie (cal): A unit of heats required raising the temperature of 1 g of water from 14.5–15.5°C. The international table calorie equals 1.00032 cal.

Capillary potential or Buckingham's potential: It is a measure of the attraction forces with which water is held by a soil. It is usually expressed in terms of work that must be done to move water against the capillary forces of the soil. Buckingham (1907) who originally losses applied to the soil in one irrigation application and which is needed to bring the soil water content of root zone to field capacity; mm.

Capillary rise: The rise of a liquid in a capillary tube may be obtained by computing the pressure exerted by the hanging water column. Water 'hangs' around the perimeter of the tube by virtue of adsorption forces between the tube surface and the liquid and the cohesive forces in the liquid surface or surface tension. Capillary rise (h) can be given as:

$$h = \frac{2\sigma}{r\rho g} \text{ (or) } h = \frac{2\sigma \cos \alpha}{r\rho g}$$

where σ is the surface tension, r is the radius of the capillary tube, ρ is the density of the liquid and ; α is the contact angle between water and soil pore (assumed to be zero).

Cell water potential: Water potential is a measure of the free energy status of water. As applied to plant cells, under isothermal equilibrium conditions, the various factors involved in cell water relations can be summarized by the following equation.

$$\Psi_{\text{cell}} = \Psi_{\text{S}} + \Psi_{\text{D}} + \Psi_{\text{M}}$$

in which Ψ_{cell} is the potential of water in the cell and the other terms express the contribution to Ψ_{cell} by solutes Ψ_{S} pressure Ψ_{D} and matric forces (Ψ_{M}). Ψ_{S} and Ψ_{M} are both negative while Ψ_{p} is positive. Ψ_{S} expresses the effect of solutes in the cell solution, and Ψ_{M} expresses the effect of water-binding colloids and surfaces in the cell. The sum of $\Psi_{\text{S}} + \Psi_{\text{p}} + \Psi_{\text{M}}$ is a negative number, except in fully turgid cells when it becomes zero. In this case, the positive pressure potential Ψ_{p} balances the sum of the negative osmotic and matric potentials. It may be shown that DPD is numerically equal to Ψ_{cell} but opposite in sign (Kramer, 1969), that is,

$$\Psi_{\text{Cell}} = \text{DPD}$$

The potential of water in a cell is less than that of pure water, *i.e.*, it is negative whereas, DPD is positive because it is defined as a deficit.

Chemical potential of water: The chemical potential of a substance in a system is a measure of the capacity of that substance to work. In a simple solution of a non-electrolyte in water, the chemical potential of water depends on the mean free energy per molecule and the concentration of water molecules.

Condensation: The physical process by which a vapour becomes a liquid or solid-opposed of evaporation.

Conduction: Conduction is the process of heat transfer through matter by molecular activity. In this process heat is transferred from one part of a body to another or between two objects touching each other. Conduction occurs through molecular movement.

Convection: Convection is the process of the transfer of heat, through movement of a mass or substance from one place to another. Convection is possible only in gases or fluids, for they alone have internal mass motions. In solid substances this type of heat transfer is impossible.

Cubic foot per second (cu sec): A continuous flow of water equal to a stream of one foot wide, one foot deep, and flowing at a velocity of one foot/second. It is equal to 0.0283 m³/sec. or 28.3 litres/second. 1 cusec = 1 acre inch/hr = 1 ha. Cm/hr = 24 ha.cm/day = 2 acre feet/day. One TMC = one thousand million cubic feet (10⁹ cubic feet) = 100 crore c.ft.

Cubic meter (M³): A volume equal to that of a cube having 1 m long, 1 m wide and 1 m deep. 1 cubic metre = 1000 litres.

Cubic metre per second (cu mec): A continuous flow of water equal to a stream of 1 metre wide and 1 metre deep flowing at a velocity of 1 metre per second.

Cyclone: Means closed circulation about a low-pressure centre, which is anti-clockwise in the Northern Hemisphere. Cyclonic whirls are the 'Storms' of middle latitude. In the temperate latitude they produce much of the winter precipitation. Around the low-pressure centres. Air circulates anti-clockwise direction in Northern Hemisphere. The air is heterogeneous in relation to temperature and moisture.

Degree days: At a given location, the period between planting and harvesting is not a specific number of calendar days but rather a summation of energy units, which may be represented as degree-days. A degree-day for a given crop is defined as a day on which the mean daily temp. is one degree above the zero temp. (That is the minimum temp. for growth) of the plant.

Dew: Dew is a common form of condensation in the environment. Dew forms on the ground and on solid objects before condensation occurs in the air. Because the ground cools rapidly than the air. Air curing in contact with cold surface may be cooled before its dew point and gets condensed and deposited.

Dew point: Temperature to which air must be cooled at constant pressure and moisture content for saturation to occur. Dew forms on automobiles and other metal objects first. Metals cool rapidly than soil (or) vegetation. Dew can form at any temperature above freezing point in tropics, often it forms at as high temperature at 21°C.

Diffusion: Movement of diffusing particles from higher concentration to lower concentration is called diffusion. It is an essential step in exchange of gasses in respiration and photosynthesis and stomatal transpiration.

Disposition of solar radiation: 25% of solar radiation is reflected back to the space by clouds (more by middle and high latitudes and less in the subtropics). 6% reflected back by air, dust and water vapour. 30% scattered downwards (more in the form of shorter wavelengths able) than that in longer wave length (red). 17% of solar radiation is absorbed by the atmosphere. (Mostly by Oxygen, O₃, CO₂ and H₂O vapour).

O ₂	– absorb the extreme UV wavelengths (0.12–0.6 μ)
O ₃	– UV (0.2 to 0.32 μ) and Visible part of radiation (0.44–0.7 μ)
H ₂ O vapour	– Near infra red (0.93, 1.13, 1.42 μ)
CO ₂	– IR band 2.7 μ.

About 50% of solar radiation reaches earth's surface, after reflection, scattering and absorption.

Visible rays 390–760 micron m, nm

$$\begin{aligned}\text{Micron} &= \frac{1}{1000000} \text{ meter} \\ &= \frac{1}{1000} \text{ mm}\end{aligned}$$

Milli micron: 10⁻⁹ m = nanometer

Distribution efficiency (Ed): Ratio of water made directly available to the crop and that released at the inlet of a block of fields: Ed = Eb/Ea; fraction.

Drainage: The process of the discharge of water from an area of soil by sheet or stream flow (surface drainage) and the removal of excess water from within the soil by downward follow-through

the soil (internal drainage). Or the means for effecting the removal of water from the surface of soil and from within the soil, *i.e.*, sloping topography or stream channel (surface drainage) and open ditches, underground tile lines, or pumped wells (artificial drainage).

Drizzle: It is “fairly uniform precipitation composed exclusively of fine drops of water (diameter less than 0.8 mm) very close to one another”. In some places drizzles is called mist. According to Donn, if the droplets in a drizzle completely evaporate before reaching the ground, the conditions is referred to as mist. However, in the International codes for weather reports, the term ‘mist’ is used when the hydrometer-mist or fog-reduces the horizontal visibility at the earth’s surface do not less than one km.

Drought year: When the rainfall is short by more than twice the deviation, the year is said to be drought year for a particular place, *e.g.*, if the normal rainfall is 1,000 mm and normal deviation is 150 mm, then if the rainfall received is less than 700 mm, it would be termed as a drought year.

Duty of water: The area of a crop in acres that can be irrigated throughout the crop period by a continuous flow of 1 cusec of water or the area of a crop in hectares that can be irrigated throughout the crop period by a continuous flow of 1 cumec of water.

Effective rainfall (ER): Rainfall useful for meeting crop water requirements; it excludes deep percolation, surface runoff and interception; mm/period.

Effective rooting depth (D): Soil depth from which the full-grown crop extracts most of the water needed for evapotranspiration; m.

Electrical conductivity (Ec): Ec is the property of the medium of transferring electric charge. It is the reciprocal of electrical resistivity and is expressed in reciprocal of Ohms (mhos) per cm at 25°C.

Emissivity: Emissivity is defined as the ratio of the radiant energy emitted by a given surface to the total heat energy emitted by a black body. The emissivity of a black body is unity.

Energy measurement

Units	Cal cm ⁻² min ⁻¹	J cm ⁻² mi ⁻¹	W cm ⁻²
Cal cm ⁻² min ⁻¹	1	4.1868	0.069
J cm ⁻² mi ⁻¹	0.238	1	0.00165
W cm ⁻²	14.3	60.6	1

Energy balance or heat balance: The net radiation is the difference between total incoming and outgoing radiations and is a measure of the energy available at the ground surface. It is the energy available at the earth’s surface to drive the processes of evaporation, air and soil heat fluxes as well as other smaller energy consuming processes such as photosynthesis and respiration. The net radiation over crop is as follows:

$$R_n = G + H + LE + PS + M$$

R_n is net radiation, G is surface soil heat flux, H is sensible heat flux, LE is latent heat flux, PS and M are energy fixed in plants by photosynthesis and energy involved in respiration, respectively. The PS and M are assumed negligible due to their minor contribution (about 1–2% of R_n). The net radiation is the basic source of energy for evapotranspiration (LE), heating the air (H) and soil (S) and other miscellaneous M including photosynthesis.

Equator: An imaginary circle around the earth, equally distant at all points from both the North pole and the south pole. It divides the earth’s surface into the northern Hemisphere and the southern Hemisphere.

Equivalent weight: The weight in grams of an ion or compound that combines with or replaces one gram of hydrogen. The atomic weight or formula weight divided by its valence.

Exchangeable cation: A cation that is adsorbed on the exchange complex and which is capable of exchange with other cations.

Exchangeable sodium percentage: The degree of saturation of the soil exchange complex with sodium. It may be calculated by the formula:

$$\text{ESP} = \frac{\text{Exchangeable sodium (meq/100 g soil)}}{\text{Cation-exchange-capacity (meq/100 g soil)}} \times 100$$

Extra-terrestrial radiation (Ra): Amount of solar radiation received on a horizontal plane at the top of the atmosphere; equivalent evaporation mm/day.

Farmer: Etymologically a farmer is a person who cultivates a farm which is basically pertaining to agriculture. The Ministry of Agriculture and Irrigation, Government of India, defined marginal, small, semi-medium, medium and large farmers as the households having <1 acre (1 acre = 0.4047 ha), 1–2 acres, 2–4 acres, 4–10 acres and >10 acres of land respectively (Ministry of Agriculture and Irrigation, Government of India, 1970–71). However in West Bengal, marginal, small, medium and large farmers are considered as those who possess < 2.5 acres, 2.5–5 acres, 5–10 acres and >10 acres of land respectively.

Field application efficiency (Ea): Ratio of water made directly available to the crop and that received at the field inlet.

Field capacity (Fc): Depth of water held in the soil in absence of ET after ample irrigation or heavy rain when the rate of downward movement has substantially decreased, usually 1–3 days after irrigation, or rain. Soil water content at soil water tension of about 0.1–0.3 atmosphere.

Fifteen-atmosphere percentage: It is the moisture percentage on dry-weight basis of a soil sample, which has been wetted and brought to an equilibrium in a pressure membrane plate apparatus at 15 atm pressure (221 lb/sq. inch). This characteristic moisture value for soil approximates the lower limit of water available for crop growth, which is also referred to as PWP.

Fog: Fog is a condensed water droplet suspended in air in the lower atmosphere (surface of the earth). Condensed water droplets around nuclei are called cloud. Fog reduces the horizontal visibility. They frequently occur in super cold. Liquid at temperature much below the freezing. Accumulation of dust or smoke fog in air is called dust fogs or smoke fogs. Thick fogs are more frequent in smoke cities. The blend of smoke and fog is called 'smog'.

Free flow: It is a condition under which the rate of discharge is solely dependent on the length of crest and depth of water at 'Ha' in the converging section of the Parshall flume. At free-flow the ratio of Hb and Ha equals or is less than 0.6.

Gas constant: The constant factor in the equation of state for perfect gases. The universal gas constant is $R = 8.314 \times 10^7 \text{ erg mol}^{-1} \text{ } ^\circ\text{K}^{-1}$.

Global radiation: The total of direct solar radiation and diffuse sky radiation received by a unit horizontal surface (essentially less than about 3 microns).

Ground water table: Upper surface of free water accumulating in lower depths or saturating the underlying sand or gravel. Furnishes supplies for shallow spring and wells; water table of more than 180–240 cm below the bottom of the root zone is not of much use to the plants.

Ground water: The water that occurs in the zone of saturation, from which wells and springs or open channels are fed. This term is sometimes used to include also the suspended water and is loosely synonymous with subsurface water, underground water or sub-terranean water.

Hail: It is “Precipitation of small balls or pieces of ice (hailstorms) with a diameter ranging from 5 to 50 mm or sometimes more, falling either separately or agglomerated into irregular humps. It is always produced by convective clouds, usually cumulonimbus.

Hail Storm: Small round pieces of ice (hail) that sometimes fall during thunderstorms (frozen raindrops, hailstorms). Hails may be sometimes greater in size than a large marble. It falls from cumulonimbus clouds. Hails are destructive to crops—mechanical damage, structures etc.

Heat: It is the aggregate internal energy of motion and molecules of a body. It is often defined as energy in the process of being transferred from one object to another because of the temperature between them.

Heat budget: If the total solar radiation reaches the outer limit of the atmosphere, about 32 per cent is reflected by clouds of scattered back to space by suspended particles and it is not used to heat the air. The earth surface reflects 2 per cent of radiation to the space. The total reflectivity is known as earth’s “albedo”. The average albedo value for the earth is 34 per cent. About 19 per cent of solar radiation is absorbed by gases and water vapour, about 24 per cent is absorbed the earth from scattering of clouds and atmosphere. Thus approximately two-thirds of the total radiation is effective in heating the earth.

Heat Wave: A region is considered to be in the grip of moderate heat wave when it recorded maximum temperature exceeds the normal by 5°–8°C. Heat wave is common in UP (54% Probability) in the month of June. Incidence is maximum in Western UP. Persistence is 5–6 days particularly more in June.

Effect of Heat Wave: Already dealt in effect of temperature on crop growth. Thermal death point affects photosynthesis and respiration. Increased respiration depletion of reserve food, sun clad, stem girdle.

Hectare-centimeter: A volume of water necessary to fill an area of 1 hectare of land to a depth of 1 cm. $1 \text{ ha. cm} = 100 \text{ m}^3 = 1,00,000 \text{ litres}$.

Hectare-meter: A volume water required to irrigate one hectare of land to a depth of 1m. $1 \text{ ha m} = 10,000 \text{ m}^3$.

Hurricane: A violent tropical cyclone with wind speed of 73 or more miles per hour or 134 and more km/h usually accompanied by torrential (very heavy fall) rain, originating usually in West Indian regions.

Hydraulic conductivity: Hydraulic conductivity is the proportionality factor k in Darcy’s law ($v = ki$, in which v is the effective flow velocity and i is the hydraulic gradient). It is, therefore, the effective flow velocity at unit hydraulic gradient and has the dimensions of velocity (LT^{-1}). The values of k depend on the properties of the fluid with the porous medium, such as swelling of a soil. A soil that has high porosity and coarse open texture has a high hydraulic conductivity value. For two soils of the same ‘total’ porosity, the soil with small pores has lower conductivity than the soil with large pores because of the resistance to flow in small pores. A soil with pores of many sizes conducts water faster if the large pores form a continuous path through the profile. In fine-textured soils, hydraulic conductivity depends almost entirely on structural pores. In some soils, particles are cemented together to form nearly impermeable layers commonly called *hardpans*. In other soils, very finely divided or colloidal material expands on absorbing water to form an impervious gelatinous mass that restricts the movement of water.

Hydraulic gradient: Hydraulic gradient is the rate of change of piezometric or hydraulic head with distance. Hydraulic gradient of ground water records the head consumed by friction in the flow in unit distance since in ground water flow the velocity heads are generally negligible.

Hydraulic pressure: The pressure in a fluid in equilibrium, which is due solely to the weight of fluid above.

Hydrosopic coefficient: It is the amount of moisture in dry soil when the same is in equilibrium with some standard relative humidity near a saturated atmosphere (about 98 per cent) expressed in terms of percentage on the basis of oven-dry soil.

Hygrosopic water: Hygrosopic water is that which is absorbed from an atmosphere of water vapour as a result of attractive forces in the surface of particles.

Imbibition: The first process in the absorption of water by the plant is the imbibition of water by the cell walls of root hairs.

Indicator plant: Indicator plant is one, which reflects specific growing conditions either by its presence or character of growth. Such as plant indicates water stress earlier than main crop plants.

Infiltration: It is defined as the process of entry of water into the soil profile through the surface of soil or The downward entry of maximum rate at which a soil under a given condition and at a given time can absorb water when there is no divergent flow at borders.

Infiltration rate: It is defined as the rate of entry of water into the soil profile and expressed as cm/hr.

Infrared radiation: Electromagnetic radiation lying outside the red band with wavelength between about 0.8 mm.

Insolation: Electro magnetic energy radiated into the space by the sun

Intrinsic permeability: Intrinsic permeability is the factor k in the equation $V = k \frac{dgi}{\eta}$, where V = flow velocity, d = density of liquid, g = scalar value of acceleration due to gravity, I = hydraulic gradient and η = viscosity of fluid.

Irrigation efficiency: The ratio of the volume of water required for a specific beneficial use as compared to the volume of water delivered for this purpose. It is commonly interpreted as the volume of water stored in the soil for evapo-transpiration compared to the volume of water delivered for this purpose.

Irrigation interval: Time between the start of successive field irrigation applications on the same field; days

Irrigation requirement: Refers to the quantity of water, exclusive of precipitation, required for crop production. This amounts to net irrigation requirement plus other economically unavoidable losses. It is usually expressed in depth for a given time.

Irrigation response: Irrigation response is the rate of increase in crop yield per unit of increase in water applied.

Isobar: A line of equal pressure.

Isohyet: A line of equal precipitation.

Isohyets: Isohyets are the lines connecting various locations, having an equal amount of precipitation.

Isotach: A line of equal wind speed.

Isotherm: A line of equal temperature.

Kinetic energy: Energy of motion.

Laminar flow: A flow in which fluid moves smoothly in streamlines in parallel layers or sheets (no turbulent flow).

Latent heat: It is the energy required to change a substance to a higher state of matter. This same energy is released on the reverse process. Change of state through evaporation and condensation is known as latent heat of evaporation and latent heat of condensation. From water to water vapour takes 600 calories and water to ice takes 80 calories.

Latitude: Angular distance, measure in degrees, north or south from the equator.

Leaching requirement: The fraction of the water entering the soil that must pass through the root zone in order to prevent soil salinity from exceeding a specified value. Leaching requirement is used primarily under steady state or long time average conditions.

Leaf area index: The area of one side of leaves per unit area of land surface.

Longitude: (Length) distance east or west on the earth's surface measured as an arc of the equator (in degrees up to 189° or by the difference in time) between the meridian passing through a particular place and a standard or prime meridian, usually the one passing through Greenwich, England.

Long-wave radiation: Electromagnetic radiation with a wavelength greater than 0.8 microns.

Low/Depression: When the isobars are circular or elliptical in shape, and the pressure is lowest at the centre, such a pressure system is called 'Low' or 'Depression' or 'Cyclone'. The movement will be anti-clockwise in the Northern hemisphere while it is clockwise in the southern hemisphere. Wind speed hardly exceeds 40 km per hour.

Meridian: A great circle of the earth passing through the geographical poles and any given point on the earth's surface. (Geographical)

Microclimate: The pattern of variation in temperature, moisture, etc., over a small area, *i.e.*, the sequence of atmospheric changes with a very small region.

Moisture percentage—Dry weight basis: The weight of water per 100 units of weight of material dried to constant weight at a standard temperature. **Depth basis:** The equivalent depth of free water per 100 units of depth of soil. Numerically this value approximates the volume of water per 100 units of volume of soil.

Mole: A unit of mass numerically equals to the molecular weight of the substance.

Mulch: Mulch is natural or artificially applied layer of plant residues or other material on the surface of the soil with the object of moisture conservation, temperature control, prevention of surface compaction or crusting, reduction of run off and erosion, improvement in soil structure or weed control.

Net irrigation requirement: Depth of water required for meeting evapo-transpiration minus contribution by precipitation, ground-water, stored soil water; does not include operation losses and leaching requirements; mm/period.

Net radiation (R_n): Balance between all incoming and outgoing short and long wave radiation; $R_n = R_{ns} + R_{nl}$; equivalent evaporation; mm/day.

Non saline alkali soil: A soil that contains sufficient exchangeable sodium to interfere with the growth of most crop plants and does not contain appreciable quantities of soluble salts. The exchangeable sodium percentage is greater than 15 and the electrical conductivity of the saturation extract is less than 4 m mhos/cm (at 25°C). The pH reading of the saturated soil paste is usually greater than 8.5.

Oasis effect: Effect of dry fallow surrounds on the micro-climate of a relatively small acreage of land, where an air mass moving into an irrigated area will give up sensible heat. For small field, this may result in a higher ET crop as compared to predicted ET crop using a climatic data collected inside the irrigated area; conversely ET crop predictions based on weather data collected outside the irrigated fields may over-predict actual evapo-transpiration losses.

Osmosis: The movement of water from lower concentration to a higher concentration or higher potential to lower potential through a permeable membrane.

Osmotic pressure: When a solution is separated from pure solvent by membrane permeable only to the solvent there tends to be a net flux of solvent into the solution since the chemical potential of the solvent is higher in the pure phase than in the solution. This process is called osmosis and the pressure difference, which must be applied to the solution to prevent a net flux of solvent, is called osmotic pressure. In general dehydration is accompanied by an increase in osmotic pressure. Osmotic pressure, however, is not sufficiently sensitive to be used as an indicator of small changes in water balance.

Pan coefficient (K_p): Ratio between reference evapo-transpiration ET_0 and water loss by evaporation from an open water surface of a pan; $k = ET_0/E$ pan fraction.

Pan evaporation (E pan): Rate of water loss by evaporation from an open water surface of a pan mm/day.

Peasant: Peasants are rural cultivators. They raise crops and livestock in the countryside, not in greenhouses in the midst of cities.

Perched water or perched ground water: Ground water of a limited aquifer embedded in different depths on small impermeable or relatively impermeable layers.

Percolation: Percolation is the downward movement of water through saturated or nearly saturated soil in response to the force of gravity. Percolation occurs when water is under pressure or when the tension is smaller than about $\frac{1}{2}$ atmosphere. *Percolation rate* is synonymous with infiltration rate with the qualitative provision of saturated or near saturated conditions.

Permanent wilting point: Permanent wilting point is the moisture content in percentage of a soil at which nearly all plants wilt and do not recover in a humid dark chamber, unless water is added from an outside source. This is the lower limit of available moisture range for plant growth. Below the wilting point, extraction of moisture continues for some time but growth ceases completely. The force with which moisture is held by the soil at this point corresponds to 15 atm.

Permeability: It is the characteristic feature of soil medium referring to its ability or capacity with which it conducts water or fluids, under normal conditions. It depends upon soil porosity and fluid density. Pore space percentage can be calculated by using particle density and bulk density.

PF: is the logarithm of height in cm of a column of water, which represents the total stress with which water is held by a soil.

Piezometer: It is a hollow pipe with opening at the bottom used to measure pressure of ground water at the point of entry.

Plank's law: Plank introduced the 'particle concept'. The electromagnetic radiation consists of a stream or flow of particles or quanta, each quantum having energy content E determined by of each quantum is proportional to the frequency given by the equation.

$$E = hv \text{ where,}$$

$$h = \text{Plank's constant } (6.62 \times 10^{-34} \text{ J sec}^{-1})$$

$$V = \text{Frequency}$$

The law states that greater the frequency (shorter wave length) greater is the energy of quantum.

Potassium adsorption ratio (PAR): A ratio for soil extract and irrigation waters used to express the relative activity of potassium ions in exchange reactions with soil.

$$PAR = \frac{K^+}{(Ca^{++} + Mg^{++})/2}$$

where the ionic concentration are expressed in meq/litre.

Potential evaporation: It represents evaporation from a large body of free water surface. It is assumed that there is no effect of advective energy. It is primarily a function of evaporative demand of climate.

Potential evapo-transpiration (PET): It is amount of water evapo-transpired in unit time from a short uniform green crop growing actively and covering an extended surface and never short of water.

Precipitation: Precipitation has been defined as water in liquid or solid forms falling to the earth. Precipitation occurs in a variety of forms such as rainfall, snow, hail, fog and dew. Fog, dew and front

are condensation forms and are not considered to be precipitation. Common precipitation forms are Rain, Drizzle, Snow, Hail and sleet etc., are the common forms of precipitation. Precipitated moisture falling on the ground takes various forms, which depend on the following conditions.

- The temperature at which condensation takes place.
- The conditions encountered as the particles pass through the air.
- The type of clouds and their heights from the ground.
- The processes generating precipitation. All forms of precipitation regardless of appearance are collectively termed 'hydrometers'.

Pressure gradient: The rate of decrease of pressure in space at a given time.

Psychrometer: Device to measure air humidity; normally consisting of two standard thermometers, one of whose bulb is surrounded by a wet muslin bag and is called wet-bulb thermometer; both should normally be force-ventilated and shielded against radiation (Assmann type).

Radiation: Radiation is the process of transmission of energy by Electro magnetic waves and is the means by which energy emitted by the sun reaches the earth.

Radiation balance: The difference between all incoming and outgoing radiation at the earth's surface and top of the atmosphere is known as radiation balance at the earth's surface.

Radiation laws: The direct transfer of heat from the sun to the earth through the space and atmosphere indicates that radiation of heat from one place to other occurs in the form of electromagnetic waves in the same manner and with same speed of as light. The wavelength of electromagnetic radiation is given by the equation

$$\lambda = \frac{C}{V}$$

Where λ = Wavelength (The shortest distance between consecutive crests in the wave trance)

C = Velocity of light (3×10^{10} cm sec⁻¹)

V = Frequency means number of vibrations of cycles per second.

Rain: It is precipitation of liquid water particles either in the form of drops having diameter greater than 0.5 mm or in the form of smaller widely scattered drops. When the precipitation process is very active, the lower air is moist and the clouds are very deep, rainfall is in the form of heavy downpour. On occasions, falling raindrops completely evaporate before reaching the ground.

Red colour of the sky at sunset and sunrise: It is because of increased path length in the atmosphere. % of solar energy in the visible part decreases. With in the visible part, the ratio of the blue to the red part decreases with increased path length.

Reference crop evapo-transpiration (ET₀): Rate of evapo-transpiration from an extended surface of 8–15 cm tall, green grass cover of uniform height, actively growing, completely shading the ground and not short of water; mm/day.

Reflection coefficient: The ratio of amount of solar radiation reflected by a body to the amount incident upon it.

Reflectivity: Reflectivity is defined as the ratio of the radiant energy reflected to the total incident radiation upon that surface. If it is expressed in percentage it becomes albedo.

Relative Humidity: The ratio between the amount of water vapour present in a given volume of air and the amount of water vapour required for saturation under fixed temperature and pressure.

Salinisation: The process of accumulation of soluble salts in soil at or when air is saturated at given air temperature; millibar (mb) or mm of Hg.

Saturated air: Moist air in a state of equilibrium with a plane surface of pure water or ice at the same temperature and pressure. In such a state the relative humidity is 100 per cent and the amount of water vapour is maximum for the given temperature.

Saturation deficit (also called vapour pressure deficit): The difference between the actual vapour pressure and the saturation vapour pressure at the existing temperature.

Seepage or inflow: The sideward or lateral water movement is termed as seepage or inflow. This will occur both vertically and horizontally. The capillary rise is the reason for seepage in surface layer. Practically it is impossible to separate the water movement as percolation and seepage but for our study purpose, the seepage and percolation can be separated and calculated through some methods.

Semi permeable membrane: A membrane that permits the diffusion of one components of a solution but not the other. In biology, a septum which permits the diffusion of water but not the solute.

Sensible heat: It is the heat that can be measured by a thermometer and thus sensed by humans. Normally measured in Celsius, Fahrenheit and Kelvin.

Short-wave radiation: A term used loosely to distinguish solar and diffuse sky radiation from long-wave radiation.

Sleet: It refers to precipitation in the form of a mixture of rain and snow. It consists of small pellets of transparent ice, 5 mm or less in diameter. It refers to a frozen rain that forms when rain falling to the earth passing through a layer of cold air and freezes. This happens when temperature is very low. It is not commonly seen in India except high ranges, that too in winter, in extreme north and north-east India.

Snow: It is precipitation of white and opaque grains of ice. "In winter, when temperature is below freezing in the whole atmosphere, the ice crystals falling from the alto-stratus" does not melt and reach the ground as snow. Heaviest snowfall is reported to occur when the temperature of air from which snow is falling is not much below 0°C. Because under such a condition the moisture content is fairly high. A snow cover is a poor conductor of heat and keeps the soil temperature higher. It prevents soil freezing and thus protects the roots of the plants. Snow accumulated during winter on the mountains and melts in summer which supplies water for maintaining flow in the rivers.

Sodium adsorption ratio: A ratio for soil extracts and irrigation waters used to express the relative activity of sodium ions in exchange reactions with soil.

$$\text{SAR} = \frac{\text{Na}^+}{\sqrt{(\text{Ca}^{++} + \text{Mg}^{++})/2}}$$

Where the ionic concentrations are expressed in milli equivalents (me) per litre.

Soil structure: Arrangement of soil particles into aggregates, which occur in a variety of, recognized shapes, sizes and strengths.

Soil temperature: In many cases soil temperature is more important to plant life than air temperature. It influences the germination of seeds and root activities. It influences the soil-borne diseases like seedling blight, root rot etc. The decomposition of organic matter will be higher in higher soil temperature with necessary moisture. It controls the nutrient availability. In tropics high temperature of soil causes regeneration of potato tubers. It also affects nodulation in legumes.

Soil texture: Characterization of soil in respect of its particle size and distribution.

Soil water stress: Sum of soil water tension and osmotic pressure to which water must be subjected, to be in equilibrium with soil water; also called soil water potential; atmosphere or bar.

Soil water tension: Force at which water is held by the soil or negative pressure or suction that

must be applied to bring the water in a porous cup into static equilibrium with the water in the soil; soil water tension does not include osmotic pressure; also called matric potential; atmosphere or bar.

Solar Constant: The sun is the source of more than 99 per cent of the thermal energy required for the physical processes taking place in the earth atmosphere system. Every minute, the sun radiates approximately 56×10^{26} calories of energy. In terms of the energy per unit area incident on a spherical shell with a radius of 1.5×10^{13} cm (the mean distance of the earth from the sun) and concentric with the sun, this energy is equal to

$$S = \frac{56 \times 10^{26} \text{ cal. Min.}^{-1}}{4\pi (1.5 \times 10^{13} \text{ cm})^2} = 2.0 \text{ langely min}^{-1}.$$

The solar constant (S) is a true constant, but fluctuates by as much as 3.5 percent about its mean value, depending upon the distance of earth from the sun (Langley = gram calories cm^{-2}). Solar constant = 2.0 gram calories $\text{cm}^{-2} \text{ min}^{-1}$.

1. Shorter than visible range: Chemically very active

- When plants are exposed to this radiation the effects are detrimental.
- Atmosphere acts as regulator for this radiation and none of cosmic, Gamma and X-rays reaches to the earth.
- The UV rays of this segment reaching to the earth are very low and it is normally tolerated by the plants.

2. Higher than visible wavelength:

- Referred to IR radiation
- It has thermal effect on plants
- In the presence of water vapour, this radiation does not harm plants, rather it supplies the necessary thermal energy to the plant environment.

3. Visible spectrum:

- Between UV and IR radiation and also referred as light
- All plant parts are directly or indirectly influenced by the light
- Intensity, quality and duration are important for normal plant growth
- Poor light leads to plant abnormalities
- Light is indispensable to photosynthesis
- Light affect the production of tillers, the stability, strength and length of culms
- It affects the yield, total weight of plant structures, size of the leaves and root development.
- Critical stages of plant growth for light
 - Radiation intensity during the third month of Maize plant
 - Rice—25 days prior to flowering
 - Barley—flowering period

<i>Band</i>	<i>Wavelength (nm)</i>	<i>Specific effect on plant</i>
1.	Radiation within 1000 and more	No specific effect on plant activity. Radiation absorbed by plants is transformed into heat. This radiation does not interfere with bio-chemical processes.
2.	1000–720	Radiation in this band helps in plant elongation, can be accepted as an adequate measure of plant elongation activity. The far red region (700–920 nm) has important role on photo-periodism, germination of seeds, flowering and colouration of fruits.
3.	720–510	In this spectral region light is strongly absorbed by chlorophylls. It generates strong photosynthetic and photo-periodic activity.
4.	610–510	This is green-yellow region. Absorption in this spectral region has low photosynthetic effectiveness and weak formative activity.
5.	510–400	It is the strongest chlorophyll and yellow pigment absorption region. In the blue-violet range, photosynthetic activity becomes very strong. This region has very strong effect on formation of tissues.
6.	400–315	Radiation in this band produces formative effects. It has dwarfing effect on plants and thickening effect on plant leaf.
7.	315–280	Radiation in this band has detrimental effect on most plants
8.	Less than 280	Lethal effect- most of the plants get killed due to radiation in this band UV ranges have germicidal action.

A part of the incident radiation on the surface is absorbed, while a part is reflected and the remaining is transmitted.

Solar radiation: The flux of radiant energy from the sun is solar radiation. Heavenly bodies emit–short wave radiation and Near surfaces including earth emit–long wave radiation.

Specific heat: The heat capacity of a system per unit mass.

Specific humidity: The ratio of the mass of water vapour in a volume of moist air to the total mass of the volume of moist air.

Spectrum of Radiation

<i>Band</i>	<i>Spectrum</i>	<i>Wavelength (μ)</i>	<i>Importance</i>
Ultra violet	Cosmic rays	< 0.005	Shorter wave lengths of spectrum and Chemically active, unless filtered there is danger of life on earth
	Gamma rays and X-rays	0.005–0.20	
	Ultraviolet rays	0.20–0.39	

(Contd.)

<i>Band</i>	<i>Spectrum</i>	<i>Wavelength (μ)</i>	<i>Importance</i>
Visible	Violet	0.39–0.42	Visible spectrum known as Light essential for all plant processes
	Blue	0.42–0.49	
	Green	0.49–0.54	
	Yellow	0.54–0.59	
	Orange	0.59–0.65	
Infra red	Red	0.65–0.76	Essential for thermal energy of the plant (Source of heat)
	Infrared rays	> 0.76	

Units of measurements of wavelength

Micron, $1\mu = 10^{-6} \text{ m} = 10^{-4} \text{ cm}$

Milli micron, $1 \text{ m}\mu = 10^{-9} \text{ m} = 10^{-7} \text{ cm}$

Angstrom, $\text{\AA} = 10^{-10} \text{ m} = 10^{-8} \text{ cm}$

Stefan-Boltzmann's law: The intensity of radiation emitted (E) by a radiating body is directly proportional to the fourth power of the absolute temperature of that body.

(Emissivity of black body = 1)

$$E = \sigma T^4$$

Where, $T = (273 + ^\circ\text{C})$ because temperature is in Kelvin

Stefan-Boltzmann's constant which is equal to $5.673 \times 10^{-8} \text{ W m}^{-2} \text{ K}^{-4}$

Storm: A marked atmosphere disturbance characterized by a strong wind, usually accompanied by rain, snow, sleet (rain that freezes as it falls-mixture of rain with snow or hail) or hail and often thunder and lightning.

Temperature: It is defined as the measure of the average speed of atoms and molecules. $T = (273 + ^\circ\text{C})$ because temperature is in Kelvin.

Tensiometer: A device for measuring the tension of soil water in the soil consisting of a porous, permeable ceramic cup connected through a tube to a manometer or vacuum gauge.

Tornadoes: Defined as a violently rotating column of air attended by a funnel-shaped or tubular cloud extending downward from the base of cumulonimbus cloud. Tornadoes are the most violent storms of lower troposphere. They are very small in size and of short duration. They mostly occur during spring and early summer. They have been reported at widely scattered locations in the mid latitudes and tropics. Crop losses are heavy due to this event.

Transpiration: The process by which water in plants is transferred as water vapour to the atmosphere.

Turbulence: A state of fluid flow in which instantaneous velocities exhibits irregular and apparently random fluctuations.

Typhoon: Any violent tropical cyclone originating in the western pacific especially in the south China sea.

Vapour pressure: The partial pressure of water vapour in the atmosphere.

Viscosity: It is defined as the property of liquid, which oppose the relative motion among its parts. It is nothing but internal friction that makes resistance to flow of liquid.

Water potential: The capability of soil water to do work compared with free-water. The water potential at the surface of free water is taken as zero.

Water requirement (WR): Also referred as water need. It is defined, as the water needed for raising a crop in a given period. It includes consumptive use and other economically unavoidable losses and that applied for special operation such as land preparation, transplanting leaching etc., it is usually expressed as depth of water for a given time.

Watershed: Watershed is the area above a given point on a stream that contributes water to the flow at that point. Catchment basins or drainage basins are synonymous with it.

Wein's Displacement laws: The wavelength of the maximum intensity of emission (λ_{\max}) from a radiating black body is inversely proportional to its absolute temperature

$$\lambda_{\max} = 2897 T^{-1} \mu = 2897/T \mu \text{ Where T is in } ^\circ\text{K}$$

If the temperature of a body is high, radiation maximum is displaced towards shorter wavelengths. For the sun's surface temperature of 5793°K , the λ_{\max} is 0.5μ ($2897/5793$). The most intense solar radiation occurs in the blue-green range of visible light. The wavelength of maximum intensity of radiation for the earth's actual surface temperature of 14°C or 287°K is about 10.0 ($2897/287$) microns, which is in the infrared band.

Wet year: If the rainfall exceeds twice the normal deviation at a particular place, that year is said to be a wet year.

Wind vane: An instrument used to indicate wind direction.

Wind speed (U_2): Speed of air movement at 2 m above ground surface in unobstructed surrounding. Means in m/section over the period considered, or total wind run in km/day.

Zero-plane displacement: An empirically determined constant introduced into the logarithmic velocity profile to extend its applicability to very rough surfaces or to take into account the displacement of a profile above a dense crop.

For Further Reading

Principles of Agronomy

- Ahlawat I.P.S., Om Prakash and G.S.Saini.1998. Scientific Crop Production in India, Rama Publishing House, Meerut.
- Balasubramaniyan P and SP. Palaniappan. 2002. Principles and Practices of Agronomy. Agrobios (India), Jodhpur.
- Biswas T.D. and S.K. Mukherjee. 1994. Text Book of Soil Science, Tata McGraw Hill publishing company Ltd., New Delhi.
- Brady N.C., 1990. The Nature and Properties of Soils, MacMillan Publishing Co., New York, USA.
- Cheema S.S., B.K. Dhaliwal, and T.S. Sahota, 2000. Theory and Digest Agronomy, Kalyani Publishers, New Delhi.
- Chidra Singh,1997. Modern techniques of raising field crops, Oxford and IBH Publishing Co. Pvt. Ltd., New Delhi.
- Dahama A.K. 1996. Organic farming for Sustainable Agriculture, Agri. Botanical Publishers, Bikaner.
- DAS P.C. 2000. Manures and fertilizers, Kalyani Publishers, New Delhi.
- Das P.C., 1997. Oilseed crops of India. Kalyani Publishers, New Delhi.
- Gopal Chandra De, 1997. Fundamentals of Agronomy, Oxford and IBH Publishing Co. Pvt. Ltd., New Delhi.
- Gopalachari, N.C., 1984. Tobacco, ICAR, New Delhi.
- ICAR, 1996. Handbook of Agriculture, Indian Council of Agricultural Research, New Delhi.
- John M.M., 1987. Cotton. Longman Scientific and Technical, New Delhi.
- Kannaiyan S. and C.Ramasamy, 2002. Agriculture. Science, Agriculture, Policy. TNAU, Coimbatore.
- Maiti S., M.R.Hegde and S.B.Chattopadhyay, 1988. Handbook of annual oil seed crops. Oxford and IBH Publishing Co. Pvt. Ltd., New Delhi.
- Mandal R.C. and P.K. Jana, 1998. Water resource utilization and micro-irrigation; Sprinkler and Drip system, Kalyani Publishers, Ludhiana.
- Michael A.M., 1978. Irrigation – Theory and Practice, Vikas publishing House Pvt., Co. New Delhi.
- Morachan Y.B., 1980. Crop Production and Management. Oxford and IBH Publishing Co. Pvt. Ltd., New Delhi.
- Palaniappan S.P., 1985. Cropping systems in the Tropics – Principles and Management, Wiley Eastern Limited and Tamil Nadu Agricultural University, Coimbatore.
- Randhawa N.S., 1980. A history of Agriculture in India, Vols. I & II Indian Council of Agricultural Research, New Delhi.

- Rao V.S., 1983. Principles of Weed Science, Oxford and IBH, Pub. Co. New Delhi.
- Reddy S.R., 1999. Principles of Agronomy. Kalyani Publishers, New Delhi.
- Sankaran S and V.T. Subbiah Mudaliar, 1997. Principles of Agronomy. The Bangalore Printing and publishing co. Ltd., Bangalore.
- Singh S.S., 1998. Principles and Practices of Agronomy, Kalyani Publishers, New Delhi.
- Somasundaram E., K. Annadurai, M.L. Manoharan, R. Kavimani, and R.Vijayalakshmi, 2000. Hand book on Rice Production Technology, Golden net printers, Tiruchirappalli.
- Somasundaram E. and A. Arokiaraj, 2000. Text Book on Principles of Agronomy, Crystal Offset Printers, Tiruchirappalli.
- Subbiah Mudaliar V.T., 1956. Common Cultivated Crops of South India. Amutha Nilayam Pvt. Ltd., Madras.
- Subbian P. K., Annadurai, K and S.P. Palaniappan, 2000. Agriculture Facts and Figures, Kalyani Publishers, New Delhi.
- Thakur C., 1980. Scientific Crop Production Vol. I, Metropolitan Book Co. Pvt. Ltd., New Delhi.
- Thakur C., 1981. Scientific Crop Production Vol. II, Metropolitan Book Co. Pvt. Ltd., New Delhi.
- Yadav J.S.P. and G.B. Singh, 2000. (Eds.,) Natural Resource Management for Agricultural Production in India, Indian Council of Agricultural Research, New Delhi.
- Yadava R.L., 1993. Agronomy of Sugarcane - Principles and Practices. International Book Distributing Co., Lucknow.
- Yellamananda Reddy T. and G.H. Sankara Reddi, 1997. Principles of Agronomy. Kalyani Publishers, New Delhi.

Weed management

- Aldrich R.J. and R.J. Kremer. 1997. Principles in Weed Management. Iowa State University Press, Iowa.
- Gupta O.P. 1998. Weed management - Principles and Practices. Agro Botanical Publishers, Bikaner.
- Rao V.S.1994. Principles of Weed Science. Oxford and IBH Publishing Co. Pvt. Ltd., New Delhi.
- Sankaran S., R. Jeyakumar and N. Kempu Chetty. 1993. Herbicide Residues. Gandhi Book House, Coimbatore.
- Subramanian S., A. Mohamed Ali and R. Jayakumar. 1997. All about weed control. Kalyani Publishers, New Delhi.

Irrigation management

- Agarwall R.R., Yadav, J.S.P., Gupta, R.N., 1982. Saline alkali soils of India. ICAR., New Delhi.
- Aruna Rajagopal, Vijayaraghavan C.R., Narayanswamy M.R., Balasubramanian P., and Venkatakrishnan A.S. 1991. An introduction to irrigation agronomy. DKV publication, Coimbatore.
- Dastane NG., 1972. A practical manual for water use research in agriculture, Navabharat – Prakashan, Pune.
- De Datta S.K., 1981. Principles and practices rice production, John Wiley and Sons Inc., New Delhi.
- Doorenbos I and W.O. Fruitt, 1977. Crop water Requirement. FAO Irrigation and drainage paper, Vol-24.
- Gupta I.C., 1990. Use of saline water in agriculture, Oxford and IBH publishing Co., Pvt., Ltd., New Delhi.
- Hiran K.S., Jaspal Singh and M.S. Acharya, 1990. Irrigation Scheduling. CBS publishers and distributors, New Delhi.
- IARI, 1977. Water requirement and irrigation management of crops in India, WTC, IARI, New Delhi.
- ICAR, 1968. Proceedings of symposium on water management, Indian Society of Agronomy, New Delhi.
- Israelson O.W. and Hansen, 1962. Irrigation- Principles and Practices, Wiley International Edition, New Delhi.
- Michael AM, 1997. Irrigation Theory and practices, Vikas publishing House Pvt. Ltd., New Delhi.

- Minhas P.S., Tyagi, N.K., 1998. Guidelines for irrigation with saline and alkali waters, CSSRI, Karnal, India P.P. 35.
- Misra R.D., and M. Ahmed, 1987. Manual on Irrigation Agronomy, Oxford and IBH publication, New Delhi.
- Prihar S.S., Sandhu. B.S. 1994. Irrigation of Field Crops - Principles and Practices. ICAR, PUSA, New Delhi.
- Sankara Reddi, G.H. and T.Yellamanda Reddy, 1997. Efficient Use of Irrigation Water. Kalyani Publishers, New Delhi.
- Singh R.P., 1996. Sustainable development of Dryland Agriculture in India. Scientific Publishers, Jodhpur.
- Sivanappan R.K. 1987. Sprinkler Irrigation. Oxford and IBH publishing Co., Pvt., Ltd., New Delhi.
- Thorne DW. And Peterson, 1954. Irrigated soils, The blackiston company, IWC, Tornato.

Dry farming

- Arnon I., 1972. Crop production in dry regions, Vol.I and II. Leonard Hill, London.
- Gupta U.S., 1995. Production and improvement of crops for drylands, Oxford and IBH Publishing Co. Pvt. Ltd., New Delhi.
- Singh R.P. 1996. Sustainable development of Dryland Agriculture in India. Scientific Publishers, Jodhpur.
- Agricultural Heritage in India
- Ayachit S.M. (Tr), 2002. Kashyapiya Krishisukti (A treatise on Agriculture by Kashyapa). Agri – History Bulletin No.4. Asian Agri History foundation, Secundrabad .
- Choudhary S.L., Sharma, G.S. and Nene, Y.L., 2000. Ancient and medieval history of Indian agriculture and its relevance to sustainable agriculture in the 21st century, Proceedings of the summer school held from 28 May to 17 June 1999. Rajasthan College of Agriculture, Udaipur, India.
- Nene Y.L. and Choudhary, S.L., 2002. Agricultural heritage of India. Asian Agri – History foundation, Secundrabad.
- Randhawa M.S., 1980 – 86. A history of Agriculture in India, Vol. I, II, III and IV. Indian council of Agricultural Research, New Delhi.
- Raychaudhuri S.P., 1964. Agriculture in ancient India. Indian council of Agricultural Research, New Delhi.
- Razia Akbar (Tr), 2000. Muskha Dar Fauni – Falahat (The art of agriculture). Agri – History Bulletin No. 3. Asian Agri. History foundation, Secundrabad.
- Sadhale Nalini (Tr) 1996. Surapala's Vrikshayurveda (The science of plant life), Asian History Bulletin No. 1. Asian – Agri – History foundation, Secundrabad.
- Sadhale Nalini (Tr), 1999. Krishi – Parashara (Agriculture by Parashara), Agri – History Bulletin No. 2. Asian Agri – History foundation, Secundrabad, India.

Agricultural meteorology

- Gopaldaswamy N., 1994. Agricultural Meteorology, Rawat publications, Jaipur, 153 p.
- Kakde J.R., 1985. Agricultural Climatology, Metropolitan Book Co. Pvt. Ltd., New Delhi.
- Mavi H.S., 1996. Introduction to Agrometeorology, Oxford and IBH Publishing Co., New Delhi.
- Murthy V.R.K., 1995. Practical manual on Agricultural Meteorology, Kalyani Publishers, Ludhiana, 86 p.
- NBSS & LUP, 1999. Agro-ecological sub regions of India for planning and development, Publications No.35, NBSS & LUP, Nagpur, 372 p.
- Pisharoty P.R., 1986. Meteorology for the Indian Farmers, ISRO Publishers, 89 p.
- Radhakrishna Murthy, V., 2002. Basic Principles of Agricultural Meteorology. BS Publications Hyderabad, 261 p.
- Venkataraman, S., Krishnan A., 1992. Crops and Weather. Indian Council of Agricultural Research, Pusa, New Delhi, 580 p.

Agronomy of field crops

- Ahlawat I.P.S., Om Prakash and G.S.Saini.,1998. Scientific Crop Production in India, Rama Publishing House, Meerut.
- Chandrasekaran B., K.Annadurai and R.Kavimani, 2007. A Textbook of Rice science. Kalyani Publishers, Jodhpur. 667p.
- Chatterjee B.N. and K.K.Bhattacharyya,1986. Principles and Practices of Grain legume production, Oxford and IBH Publishing Co. Pvt. Ltd., New Delhi.
- Chatterjee B.N. and P.K.Das, 1989. Forage crop production - Principles and Practices, Oxford and IBH Publishing Co. Pvt. Ltd., New Delhi.
- Chidda Singh, 1997. Modern techniques of raising field crops, Oxford and IBH Publishing Co. Pvt. Ltd., New Delhi.
- Das P.C., 1997. Oilseed crops of India, Kalyani Publishers, New Delhi.
- Gopalachari N.C., 1984. Tobacco, ICAR, New Delhi.
- John M.M., 1987. Cotton, Longman Scientific and Technical, New Delhi.
- Maiti S., M.R.Hegde and S.B.Chattopadhyay, 1988. Handbook of annual oil seed crops, Oxford and IBH Publishing Co. Pvt. Ltd., New Delhi.
- Ramamoorthy A., P.Subbain and K.Annadurai, 2006. Glossary of terms in crop production, Scientific publishers, Jodhpur.
- Singh R.V., 1982. Fodder Trees of India, Oxford and IBH Publishing Co. Pvt. Ltd., New Delhi.
- Singh S.S.1997, Crop management under irrigated and rainfed conditions, Kalyani Publishers, New Delhi.
- Srivastava H.C., S.Bhaskaran, K.K.G.Menon, S.Ramanujam and M.V.Rao, 1984. Pulse production - Constraints and opportunities. Oxford and IBH Publishing Co. Pvt. Ltd., New Delhi.
- Subbiah Mudaliar V.T., 1956. Common Cultivated Crops of South India, Amutha Nilayam Pvt. Ltd., Madras.
- Thakur C., 1980. Scientific crop production, Vol.I Metropolitan Book Co. Pvt. Ltd., New Delhi.
- Thakur C., 1981. Scientific crop production, Vol.II. Metropolitan Book Co. Pvt. Ltd., New Delhi.
- TNAU, 2003. Crop Production Guide, TNAU and Directorate of Agriculture, Chennai.
- Yadava R.L., 1993. Agronomy of Sugarcane - Principles and Practices, International Book Distributing Co., Lucknow.

Organic farming

- Dahama A.K., 2002. Organic Farming for Sustainable Agriculture, Agrobios (India), Jodhpur pp.301.
- Lampkin N., 1990. Organic farming, Ipswich, U.K . Farming Press Books pp.710.
- Palaniappan SP. and K. Annadurai, 1999. Organic farming: Theory and Practice, Scientific Publishers, Jodhpur.
- Sharma A.K., 2002. A Handbook of Organic Farming Agrobios (India), Jodhpur pp. 627.
- Thampan P.K., 1995. Organic Agriculture, Peekay Tree Crops Development Foundation, Cochin. pp.354.
- Vyas S.C., Smriti Vyas, Sameer Vyas and H.A. Modi, 1998. Biofertilizers and Organic farming. Akta Prakashan, Nadiad, pp.252.

Cropping and Farming system

- Chaterjee B.N. and S.Maiti, 1993. Cropping system – Theory and practice, Oxford and IBH Publishing Co. Pvt. Ltd., New Delhi.
- Palaniappan SP and K. Sivaraman,1996. Cropping systems in the tropics – Principles and management, New Age International (P) Ltd., Publishers, New Delhi.

Rangasamy A., K. Annadarai, P. Subbian and C. Jayanthi, 2002. Farming systems in the tropics, Kalyani publishers.
Panda S.C., 2003. Cropping and Farming systems, Agro bios publishers, Jodhpur.

Soils

Kanwar J.S., 1976. Soil Fertility - Theory and Practice, ICAR, New Delhi.
Mariakulandai A and T.S. Manickam, 1975. Chemistry of fertilizers and manures, Asia Publishing House, New Delhi.
Tamhane R.V., D.P. Motiramani, Y.P. Bali, and R.L. Donahue, 1966. Soils : Their Chemistry and Fertility in Tropical Asia. Prentice Hall of India, New Delhi.
Teuscher H. and Adler, R., 1960. The Soil and its Fertility, Reinhold Publishing Co., New York.
Thompson L.M. and F.R. Troeh, F.R. 1973. Soils and Soil Fertility, McGraw Hill Publishing Co., London.
Tisdale S.L., W.L. Nelson, and J.D. Beaton, 1990. Soil fertility and fertilizers, MacMillan Publishing Company, New York.

Selected References

- Agarwal R.R., Yadav, J.S.P. Gupta, R.N., 1982. *Saline alkali soils of India*, ICAR., New Delhi.
- Ahlawat I.P.S., Om Prakash and G.S. Saini, 1998. *Scientific Crop Production in India*, Rama Publishing House, Meerut.
- Ahlawat I.P.S., Om Prakash and G.S. Saini, 1998. *Scientific Crop Production in India*, Rama Publishing House, Meerut.
- Arnon I., 1972, *Crop production in dry regions*, vol-1, Leonard Hill, London.
- Aruna Rajagopal C.R. Vijayaraghavan, M.R. Narayanaswamy, P. Balasubramanian, and A.S. Venkatakrishnan, 1991. *An introduction to Irrigation agronomy*, DKV publications, Coimbatore.
- Biswas T.D. and S.K. Mukherjee, 1994. *Text Book of Soil Science*, Tata Mc-Graw Hill publishing company Ltd., New Delhi. 667p.
- Chandrasekaran B.K., Annadurai and R. Kavimani, 2006. *A Textbook of Rice Science*. Scientific Publishers, Jodhpur, India. 667p
- Chatterjee B.N. and K.K. Bhattacharyya, 1986. *Principles and Practices of Grain legume production*, Oxford and IBH Publishing Co. Pvt. Ltd., New Delhi.
- Chatterjee B.N. and P.K. Das, 1989. *Forage crop production–Principles and Practices*, Oxford and IBH Publishing Co. Pvt. Ltd., New Delhi.
- Cheema S.S., Dhaliwal B.K. and T.S. Sahota, 2000. *Theory and Digest Agronomy*, Kalyani Publishers, New Delhi.
- Chidida Singh, 1997. *Modern techniques of raising field crops*. Oxford and IBH Publishing Co. Pvt. Ltd., New Delhi.
- Chidida Singh, 1997. *Modern techniques of raising field crops*, Oxford and IBH Publishing Co. Pvt. Ltd., New Delhi.
- Dahama A.K., 1996. *Organic farming for Sustainable Agriculture*, Agri. Botanical Publishers, Bikaner.
- Das P.C., 2000. *Manures and fertilizers*, Kalyani Publishers, New Delhi.
- Das P.C., 1997. *Oilseed crops of India*, Kalyani Publishers, New Delhi.
- Dastane NG., 1972. *A practical manual for water use research in agriculture*, Navabharat–Prakashan, Pune.
- De Datta S.K., 1981. *Principles and practices rice production*. John Wiley and Sons Inc., New Delhi.
- Doorenbos I and W.O. Fruitt, 1977. *Crop Water Requirement*, FAO Irrigation and Drainage Paper. Vol-24.
- Gopal Chandra De, 1997. *Fundamentals of Agronomy*, Oxford and IBH Publishing Co. Pvt. Ltd., New Delhi.
- Gopalachari N.C., 1984. *Tobacco*, ICAR, New Delhi.
- Gupta I.C., 1990. *Use of saline water in agriculture*, Oxford and IBH Publishing Co., Pvt., Ltd., New Delhi.

- Hiran K.S., Jaspal Singh and M.S. Acharya, 1990. *Irrigation Scheduling*, CBS Publishers and Distributors, New Delhi.
- IARI, 1977, *Water requirement and irrigation management of crops in India*, WTC, IARI, New Delhi.
- ICAR, 1968, *Proceedings of symposium on water management*, Indian Society of Agronomy, New Delhi.
- ICAR, 1996, *Hand book of Agriculture*, Indian Council of Agricultural Research, New Delhi.
- Israelson O.W. and Hansen, 1962. *Irrigation Principles and Practices*, Wiley International Edition, New Delhi.
- John M.M., 1987. Cotton, *Longman Scientific and Technical*, New Delhi.
- Maiti S., M.R. Hegde and S.B. Chattopadhyay, 1988. *Handbook of annual oil seed crops*, Oxford and IBH Publishing Co. Pvt. Ltd., New Delhi.
- Mandal R.C. and P.K. Jana. 1998. *Water resource utilization and micro-irrigation; Sprinkler and Drip system*, Kalyani Publishers, Ludhiana.
- Michael A.M., 1978. *Irrigation—Theory and Practice*, Vikas Publishing House Pvt., Co. New Delhi.
- Michael AM, 1997. *Irrigation Theory and Practices*, Vikas Publishing house Pvt. Ltd., New Delhi.
- Minhas P.S., Tyagi, N.K., 1998. *Guidelines for irrigation with saline and alkali waters*, CSSRI, Karnal, India P.P. 35.
- Misra RD., Ahmed, M., 1987. *Manual on Irrigation Agronomy*, Oxford and IBH publication, New Delhi.
- Morachan Y.B., 1986. *Crop Production and Management*, Oxford and IBH Pub. Co. New Delhi.
- Palaniappan S.P., 1985. *Cropping Systems in the Tropics—Principles and Management*, Wiley Eastern Limited and Tamil Nadu Agricultural University, Coimbatore.
- Palaniappan S.P., and K. Annadurai, 1999. *Organic Farming : Theory and Practice*, Scientific publishers, Jodhpur. 287p.
- Prihar S.S., and Sandhu. B.S., 1994. *Irrigation of Field Crops principles and practices*, ICAR, PUSA, New Delhi.
- Ramamoorthy A., P. Subbain and K. Annadurai, 2005. *Glossary of terms in crop production*, Scientific publishers, Jodhpur.
- Randhawa N.S., 1980. *A history of Agriculture in India, Vols. I and II.*, Indian Council of Agricultural Research, New Delhi.
- Rangasamy A., K. Annadurai, P. Subbaian and Jayanthi Chinnusamy, 2002. *Farming systems in the tropics*, Kalyani publishers Ludhiana, India. p. 230.
- Rao V.S., 1983. *Principles of Weed Science*, Oxford and IBH, Pub. Co. New Delhi.
- Reddy S.R., 1999. *Principles of Agronomy*, Kalyani Publishers, New Delhi.
- Sankaran S. and V.T. Subbiah Mudaliar, 1997. *Principles of Agronomy*, The Bangalore Printing and publishing Co. Ltd., Bangalore.
- Singh S.S., 1999. *Principles and Practices of Agronomy*, Kalyani Publishers, New Delhi.
- Singh R.V., 1982. *Fodder Trees of India*, Oxford and IBH Publishing Co. Pvt. Ltd., New Delhi.
- Singh S.S., 1997. *Crop management under irrigated and rainfed conditions*, Kalyani Publishers, New Delhi
- Sivanappan R.K., 1987. *Sprinkler Irrigation*, Oxford and IBH publishing Co., Pvt., Ltd., New Delhi.
- Somasundaram E., K. Annadurai, M.L. Manoharan, R. Kavimani and R. Vijayalakshmi, 2000. *Hand book on Rice Production Technology*, Golden net printers, Trichirappalli.
- Srivastava H.C., S. Bhaskaran, K.K.G. Menon, S. Ramanujam and M.V. Rao., 1984. *Pulse production—Constraints and Opportunities*, Oxford and IBH Publishing Co. Pvt. Ltd., New Delhi.
- Subbiah Mudaliar V.T., 1956. *Common Cultivated Crops of South India*, Amutha Nilayam Pvt. Ltd., Madras.
- Subbian P., K. Annadurai and S.P. Palaniappan, 2000. *Agriculture Facts and Figures*, Kalyani Publishers, New Delhi.

- Thakur C., 1980. *Scientific Crop Production Vol. I*, Metropolitan Book Co. Pvt. Ltd., New Delhi.
- Thakur C. 1981. *Scientific Crop Production Vol. II*, Metropolitan Book Co. Pvt. Ltd., New Delhi.
- Thorne DW. And Peterson, 1954. *Irrigated soils*, The Blackiston Company, IWC, Tornato
- TNAU, 1999. *Crop Production Guide*, TNAU and Directorate of Agriculture, Chennai.
- Yadav J.S.P. and G.B. Singh, 2000. (Eds.) *Natural Resource Management for Agricultural Production in India*, Indian Council of Agricultural Research, New Delhi.
- Yadava R.L., 1993. *Agronomy of Sugarcane—Principles and Practices*, International Book Distributing Co., Lucknow.
- Yellamanda Reddy, T. and Sankara Reddi, G.H., 1999. *Principles of Agronomy*, Kalyani Publishers, New Delhi.

Index

A

Aberrations in rainfall 219
Ablation 604
Absolute humidity 190
Acedophytes 173
Acid soils 258
Acid sulphate soils 275
Adaptation 174
Additive series 676
Adhesion 253
Adiabatic lapse rate 208
Adjuvants 340
Advanced farming 6
Aerobic rice 541
Aeroponic 3
After cultivation 307
Agri horticulture 502
Agricultural drought 472
Agricultural education in India 165
Agricultural extension 167
Agricultural implements 66
Agricultural research in India 166
Agricultural universities 160
Agriculture 1
Agriculture Act 1
Agriculture heritage in India 29
Agrisilviculture 506
Agroclimatic normal 221
Agroclimatic zones 220
Agronomist 19
Agronomy 18
Alfisols 259
Alkali soils 263
Allelopathy 321
Alley cropping 486, 506, 677

Alley crops 174
Alluvial soils 255
Almanac 84
Alternate land use system 504
Altitude 190, 204
Alto-stratus 211
Altocumulus (AC) 210
Ancient hindu calendar 74
Ancient irrigation 112
Animals flesh as human food 152
Annual crops 170
Annual weeds 312
Antagonistic effect 335
Anthropic (Socio economic) factors 199
Antitranspirants 491, 501
Apparent specific gravity 248
Aquatic weeds 314
Arable crops 172
Arahamihira's brihat samhita 79
Arbori-horticulture 126
Aridity 469
Assartage system 5
Astro-meteorology 82
Astronomy 71
Atmosphere 204
Atmospheric drought 472
Atmospheric gases 196
Augmenting crops 174
Available soil moisture 418
Azolla 530
Azospirillum 532

B

Balanced nutrition 451
Basophytes 173

Beverages 170
Biennial crops 171
Biennials 312
Biofertilizers 446
Bioherbicides 329
Biological pest management 708
Biotic factors 198
Black cotton soils 108
Black soils 256
Blue green algae 530
Broad casting 303
Broad leaved weeds 312
Bronze age 34
Bulk density 248
Bulky organic manures 437
Button shedding 607

C

Calciphytes 173
Canal irrigation 118
Capillary pores 250
Capillary water 254
Carbon nitrogen ratio 648
Cardinal points 187
Catch crops/contingent crops 173
Cenozoic era 22
Chasmophytes 173
Chilling injury 188
Chlorosis 436
Choice of crops and varieties 100
Cirrocumulus 210
Cirrostratus 210
Cirrus 210
Climate 202
Climate change 233
Climate variability 233
Climatic factors 185
Climatology 202
Cloud seeding 212
Cloudiness 190
Clouds 210
Cohesion 253
Cold injury 188
Cold rain 211
Combine harvester 514
Common salt technique 213
Companion cropping 180
Complex fertilizers 444
Compost 111
Compound fertilizers 444

Concentrated organic manures 437
Construction of
 reservoirs 115
Coordinates 204
Cover crops 174
Cow dung as plant food 152
Critical dry spell 219
Critical percentages of plant nutrients 11
Critical period of weed competition 321
Crop diversity 99
Crop geometry 305
Crop model 231
Crop production in ancient India 95
Crop rotation 112, 181, 667, 708
Crop water requirement 351
Crop water use efficiency 398
Crop weather modelling 231
Cropping pattern 182, 667
Cropping systems 67, 182, 561
Crops and varieties 67
Curing 173, 618
Cutting 173

D

Dead animals 112
Desert soils 109, 257
Desuckering 617
Dew point 191
Dibbling 303
Direction of light 194
Dormancy 317
Drainage 407
Drilling 303
Drip or trickle irrigation system 374
Drought 471
Drug crops/medicinal plants 170
Dry farming 455
Dry ice seeding 212
Dry land farming 455
Dry land horticulture 502
Dry lands 171
Dry spells 218
Dry system or upland rice 524
Duration of light 194

E

Edaphic factors 196
Edaphology 238

Effective rainfall 360
 Effective root zone depth 423
 El nino and la-nina 236
 Emulsifiable concentrates (EC) 332
 Entisols 259
 Environmental factors 185
 Equator 204
 Evapotranspiration 215
 Exhaustive crops 173
 Exosphere 207
 Exotic crops 92
 Extended forecast 224

F

Fallow tillage 288
 Fallowing 679
 Farming systems 105
 Fauna 197
 Feed/forage 170
 Fertilizers 443
 Fibre crops 170
 Field capacity 418
 Field water use efficiency 398
 Flora 197
 Floriculture 132
 Fluffy paddy soils 270
 Flumes 380
 Food problem 16
 Food production trends 15
 Food scenario 8
 Forest and hill soils 109
 Freezing injury 188
 Fruit crops 126
 Fumigation 120

G

Gap filling 307
 General agreement on trade and tariff 3
 Geological strata 199
 Geoponic 3
 Germination 301
 Ginning 173
 Global warming 235–6
 Grading and sorting 173
 Granules 333
 Grasses 311
 Gravitational water 255

Gravity irrigation 377
 Grazing 173
 Green leaf manures 110, 437
 Green manures 437
 Green revolution 3, 691
 Greenhouse effect 234
 Gross irrigation requirement 359
 Growing degree days 512
 Growth promoters 104
 Guard/barrier crops 174

H

Halophytes 173
 Harvest index 512
 Harvest maturity 512
 Harvesting 511
 Harvesting and threshing 70
 Heat injury 189
 Heaving 189
 Hedgerow intercropping 506
 Herbicide antidote 340
 Herbicide mixtures 339
 Herbicide resistance 339
 Herbicide rotation 339
 Herbigation 331
 Heterosphere 207
 Highly permeable soils 267
 History of cotton 95
 History of rice 93
 History of sugarcane 94
 History of wheat 94
 Homospheres 207
 Hortipasture 502
 Humidity 190
 Hunter gatherers 32
 Hybrid rice 539
 Hydrological drought 472
 Hydroponic 3
 Hygroscopic water 254

I

Icar institutes 160
 Ice age 32
 Implements for wetlands 299
 In situ soil moisture conservation 504
 Inceptisols 259
 Indices of sustainability 712

Indo-genetic alluvium 108
 Indus valley civilization 153
 Integrated farming system 502
 Integrated weed management (IWM) 337, 534
 Intensive cropping 179
 Inter cultural implements 296
 Intercropping 179, 675
 Inverse yield–nitrogen law 11
 Ionosphere 207
 Iron age 34
 Irrigated crops 171
 Irrigation 344
 Irrigation frequency 359
 Irrigation management 68, 396
 Irrigation scheduling 386

K

Kautilya's arthashastra 56
 Kharif 170
 Krishi vigyan kendras 160
 Krishi-panchang 84

L

Land leveling implements 297
 Land preparation 67
 Land resources 7
 Land shaping implements 297
 Land utilization statistics 2
 Lapse rate 208
 Laterite soils 259
 Laterites 109
 Laterites and lateritic soils 257
 Latitude 189, 204
 Law of diminishing returns 11
 Leguminous green manures 635
 Lemuria civilization 28
 Length of crop season 178
 Ley farming 505
 Liebig's law of minimum 10
 Life span of animals 145
 Lift irrigation 378
 Light 193
 Light intensity 194
 Lime requirement 273
 Lithophytes 173
 Livestock in agriculture 145
 Locating water table 113
 Long range forecast 224
 Longitude 204

Low external input sustainable agriculture 699
 Low input sustainable agriculture (LEISA/LISA) 699

M

Macro climate 203
 Malthusian theory 10
 Manures 110
 Marketing 70
 Meridian 204
 Mesoclimate 203
 Mesolithic period or meso stone age 33
 Mesozoic era 22
 Meteorological drought 472
 Microclimate 203
 Millets 170
 Minimum tillage 291
 Mixed farming 6, 707
 Mixed intercropping 181
 Mixing ratio 191
 Monoculture 679
 Morphological adaptation 174
 Mulching 484, 501
 Multi tier or multistoried intercropping 677
 Multiple cropping 179, 678
 Multistoried cropping 181

N

Narcotics, fumitories and masticatories 170
 National calamities 61
 National income 13
 Natural farming 703
 Necrosis 436
 Neolithic or new stone age 5, 33
 Net irrigation requirement 358
 Neutron probe 431
 Nimbostratus 211
 Nipping 622
 Non capillary pore space 250
 Non-arable crops 172
 Non-chemical weed control measures 708
 Non-conventional green manures 635
 North east monsoon (NEM) 195, 213
 Nurse crops 174
 Nutrient recycling 715

O

Ocean currents 190
 Off season tillage 288

Oil seeds 170
 Ontogeny 170
 Organic cycle optimisation 708
 Organic farming 701
 Organic manures 437, 708
 Orifices 380
 Origin of crop plants 89
 Overlapping system of cropping 179
 Ozone 205
 Ozone layer 235
 Ozonosphere or mesosphere 207

P

Paira crop/residual crops 173
 Paleolithic 5
 Paleolithic period or old/ancient stone age 31
 Panchang 84
 Parallel cropping 180
 Parasitic weeds 314
 Particle density 248
 Pastures and grasslands 504
 Peaty soils 259
 Pedology 238
 Penning 111
 Perennial crops 171
 Perennials 312
 Perfumes 135
 Permanent wilting point 418
 Physiographic factors 199
 Physiological adaptation 174
 Physiological maturity 512
 Physiological water use efficiency 398
 Picking 173
 Pipes and siphon tubes 380
 Planetary movement 73
 Plant density 305
 Plant protection 70
 Planting 303
 Poisonous weeds 313
 Pore space 249
 Post-emergence 333
 Potential evapotranspiration (PET) 215
 Potential yield 20
 Pre-emergence 333
 Pre-monsoon dry seeding 492
 Pre-planting 333
 Precipitation 185
 Pressurized irrigation methods 369
 Primary tillage 287
 Primary tillage implements 293

Priming 173
 Problem soils 259
 Psammophytes 173
 Pulses 170

Q

Quality of light 194

R

Rabi 170
 Rain forecasting 85
 Rain gun 376
 Rain water harvesting 117
 Rainfed crops 171
 Rainfed farming 455
 Rainmaking 212
 Ratoon cropping or ratooning 179
 Ratooning 501
 Ratooning in rice 540
 Real specific gravity 248
 Reaping 172
 Reclamation 262
 Recycling 111
 Red soils 108, 256
 Reference evapotranspiration 215
 Relative humidity 190
 Relay cropping 179
 Relay intercropping 676
 Remote sensing (RS) 228
 Replacement series 676
 Research yield 20
 Resistance block 428
 Restorative crops 173
 Retting 624
 Rigveda 50
 Rishi–krishi method of vermiculture 112
 Row intercropping 181, 676

S

Safeners/protectants 340
 Saline and alkaline soils 109, 266
 Saline soils 257
 Sar 263
 Saucer shape basins 502
 Scientific agriculture 6
 Sea level rise 235
 Seasoning 173
 Seasons 65, 96, 279
 Seasons and equinoxes 72

Secondary tillage 287
 Sedges 312
 Seed 300
 Seed rate 302
 Seed treatment 302
 Seeds and sowing 67, 101
 Semi arid tropics (SAT) 456
 Semidry rice 525
 Sequence of cropping 100
 Sequential cropping 179, 678
 Shelling 173
 Shelterbelts 486
 Shifting cultivation 5
 Short range forecast 224
 Siddha 143
 Silage 665
 Silver iodide seeding 212
 Silviculture 505
 Silvipasture 506
 Slowly permeable soils 268
 Smother crops 174
 Sodic/alkali soils 258
 Soil air 197
 Soil classification 107
 Soil fertility 68
 Soil mineral matter (SMM) 197, 239
 Soil moisture constant 417
 Soil moisture tension 253
 Soil organic matter (SOM) 197, 239
 Soil organisms 197
 Soil reaction 198
 Soil structure 244
 Soil surface crusting 269
 Soil survey 276
 Soil temperature 197
 Soil types of India 108
 Soil wetness 249
 Solar radiation 192
 Sorghum poisoning (Sorghum effect) 558
 South west monsoon (SWM) 195, 213
 Sowing 302
 Sowing implements 298
 Special purpose implements 297
 Specific humidity 190
 Spices and condiments 170
 Sprinkler irrigation system 370
 Stem girdle 189
 Storage of grains 105
 Straight fertilizers 443
 Strato cumulus 211

Stratosphere 206
 Stratus 211
 Strip cropping 676
 Stripping 173
 Stubble mulch tillage or stubble mulch farming 292
 Stubble or post harvest tillage 288
 Subsidiary farming 6
 Subsistence farming 6
 Subsoil hard pans 268
 Subsurface irrigation 369
 Suffocation 188
 Sugar and starch crops 170
 Summer rainfall 214
 Summer tillage 288
 Sun clad 189
 Super rice 540
 Surface or gravity irrigation 362
 Surface tension 253
 Surge irrigation 367
 Sustainable agriculture 695
 Sustainable agroecosystems 701
 Synergistic cropping 180
 Synergistic effect 335
 System rice intensification (SRI) 541

T

Tank irrigation 377
 Temperature 186
 The zodiac 71
 Theory of avoidance 175
 Theory of factors replaceability 175
 Theory of optima and limiting factors 11
 Theory of tolerance 175
 Thinning 307
 Tillage 286
 Tilth 286
 Timber-fibre system 506
 Topography 199, 203
 Topping 617
 Toxic constituents in forages 651
 Transpiration 353
 Transplanting 303
 Trap crops 174
 Tree culture (vrksayurveda) 126
 Troposphere 206

U

Ultisols 260

V

Vapour pressure 191
Vedic civilization 48
Vedic period 50
Vegetable farming 130
Vegetation 203
Vertisol 258

W

Warm rain 211
Water drop technique 212
Water resources 8
Water soluble concentrates 333
Water vapour 205
Watershed 506
Weather 202
Weather and climate 202
Weather calendar 226
Weather forecasting 223
Weed management 67

Weeds 308
Weirs 380
Wet lands 171
Wet seeded rice/direct seeding 537
Wet spell 219
Wet system or low land rice 526
Wetttable powders (wp) 333
White revolution 3
Wind direction 195
Wind speed 195
Wind velocity 194
Winter rainfall 213
Winter tillage 288

Y

Yellow revolution 3

Z

Zaid 170
Zero tillage/no tillage/chemical tillage 292