

Packaging Design

- ▶ Marketing function of Packaging (Displays)
- ▶ Information function of Packaging (safety and legislative requirements)
- ▶ Different Packaging bring added value
- ▶ CAD systems to support Packaging design (e.g. ArtiosCAD)
- ▶ World Design Organization (www.wdo.org)
- ▶ Design Awards (e.g. reddot - <http://en.red-dot.org/>)

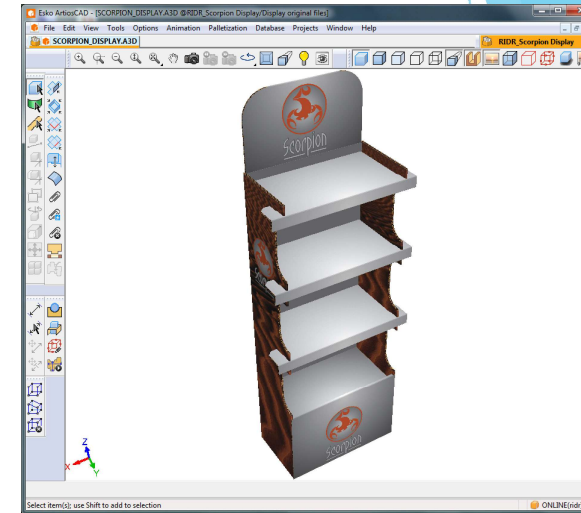

All prices Petsathome.co.uk July 2015



reddot

WORLD PACKAGING CONSUMPTION BY END-USE SECTOR 2013

Source: Smithers Pira
www.smitherspira.com

 \$ billions (2013 prices and exchange rates)

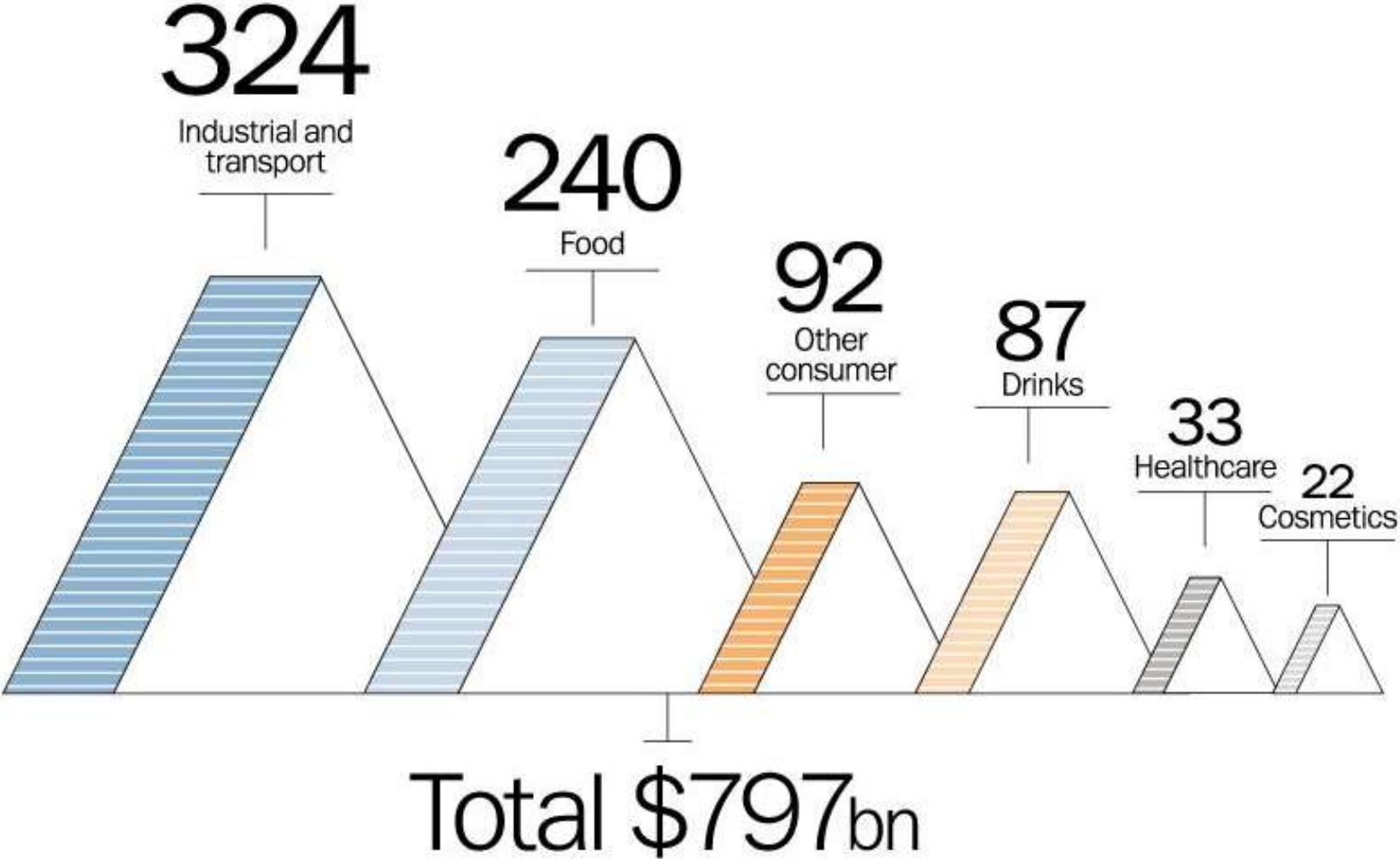

WORLD PACKAGING CONSUMPTION BY REGION 2013

Source: Smithers Pira www.smitherspira.com

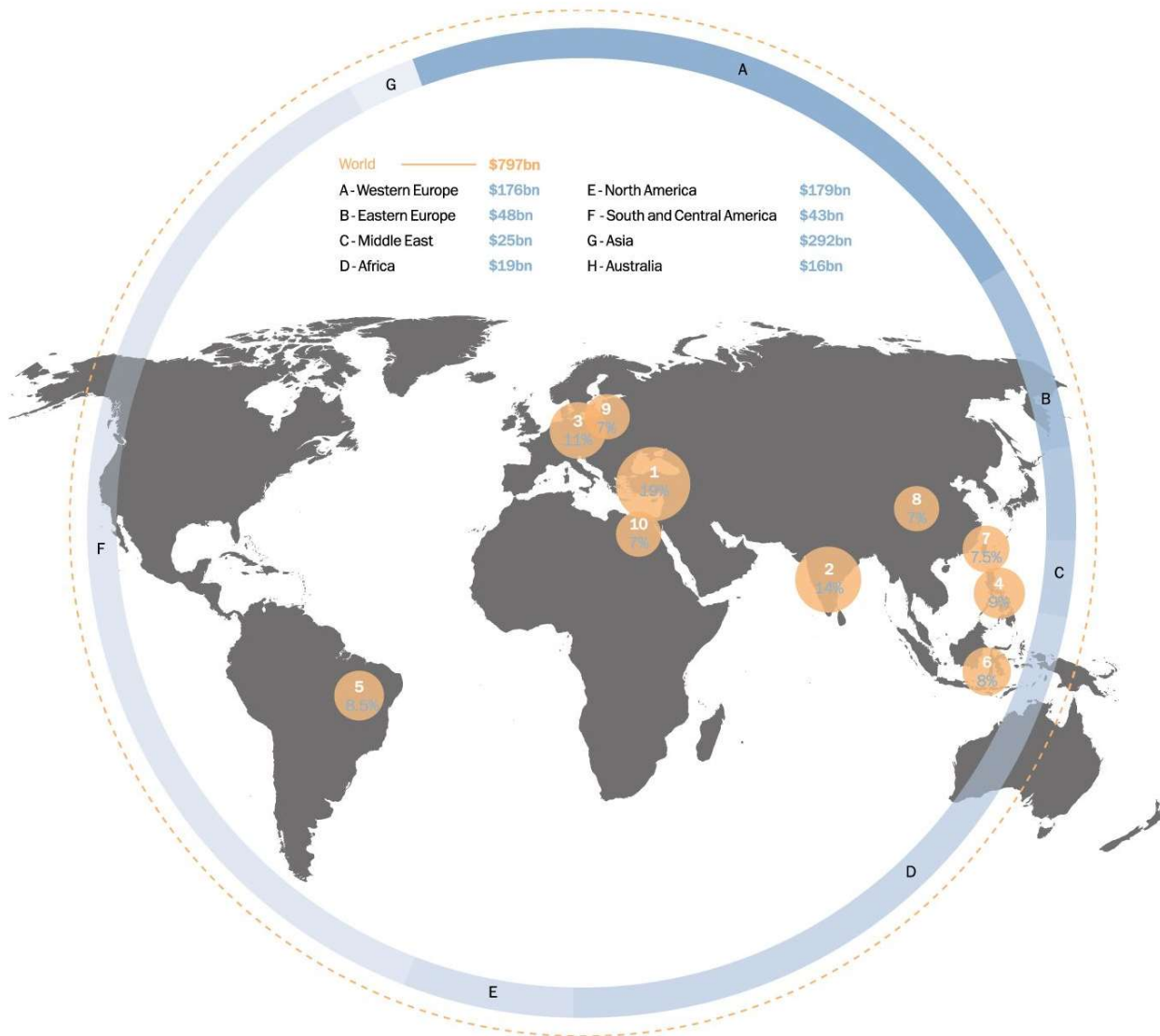

TOP 10 FASTEST GROWING NATIONAL PACKAGING MARKETS

Source: World Packaging Organisation

- | | | | | |
|----------|---------------|-------------|----------|-------------|
| 1 Turkey | 3 Poland | 5 Brazil | 7 Taiwan | 9 Lithuania |
| 2 India | 4 Philippines | 6 Indonesia | 8 China | 10 Egypt |

● Top 10 countries



INDUSTRY MARKET SHARE AND VALUE OF PACKAGING PRODUCTS

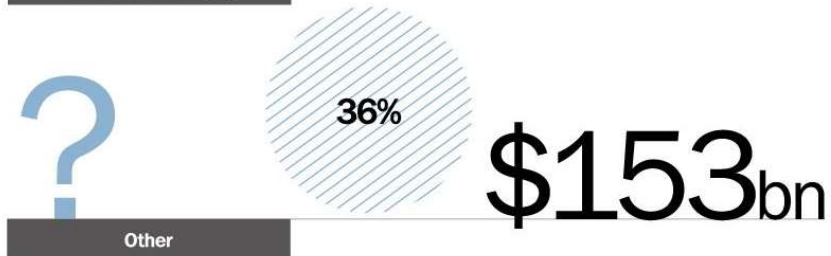
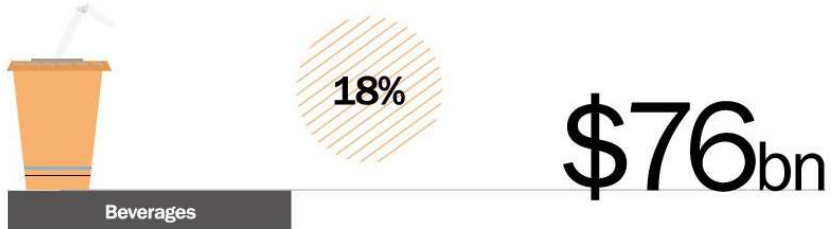
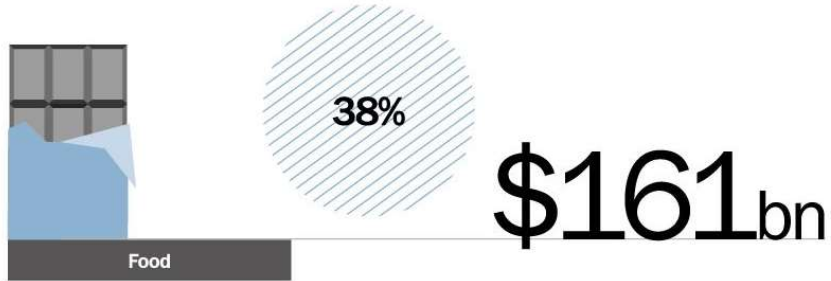

Source: World Packaging Organisation

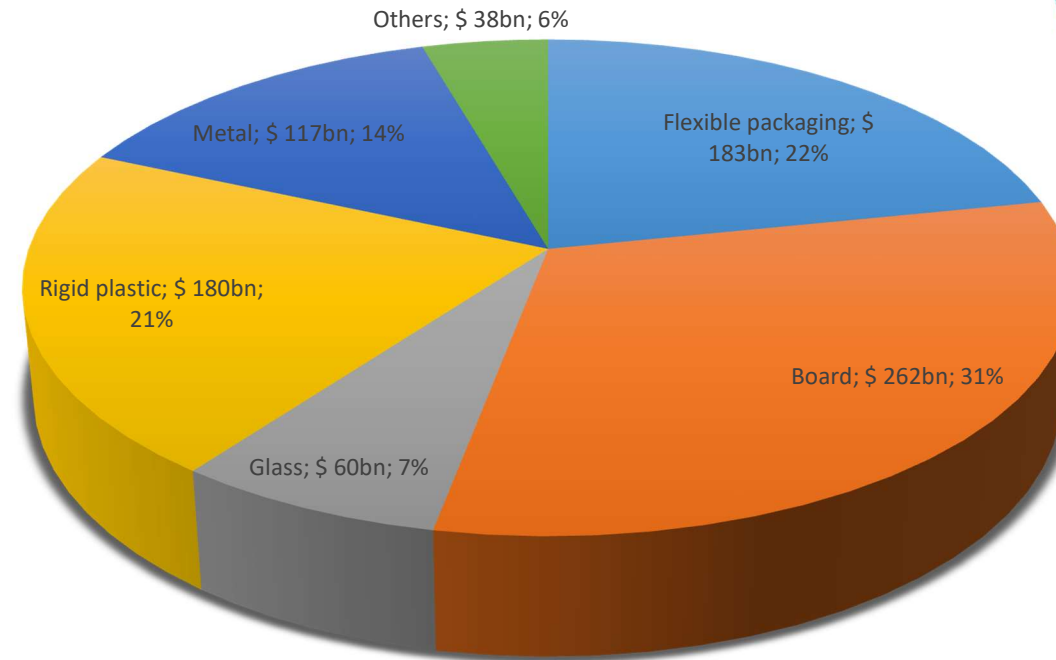

Global Packaging Market 2015: \$ 839 billion

Source: Smithers Pira

Global Paper Production 2013

by Region

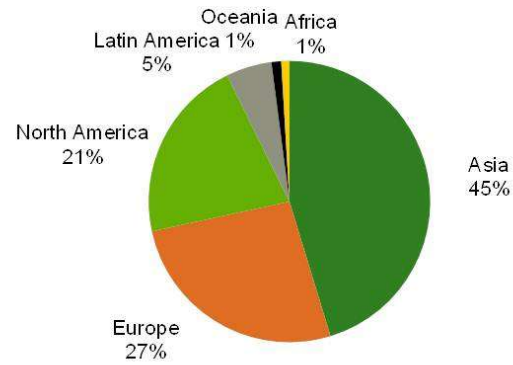

Total Production: 403 Million Tonnes (2012: 399 Million Tonnes)

Source: PPI



Global Paper Production 2013

by Grade

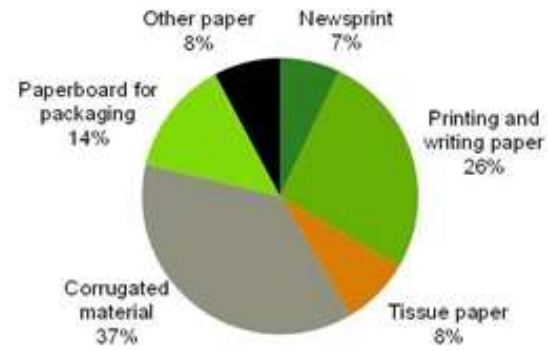

Total Production: 403 Million Tonnes (2012: 399 Million Tonnes)

Source: PPI



Forests of the World: 4 Billion Hectares 2010

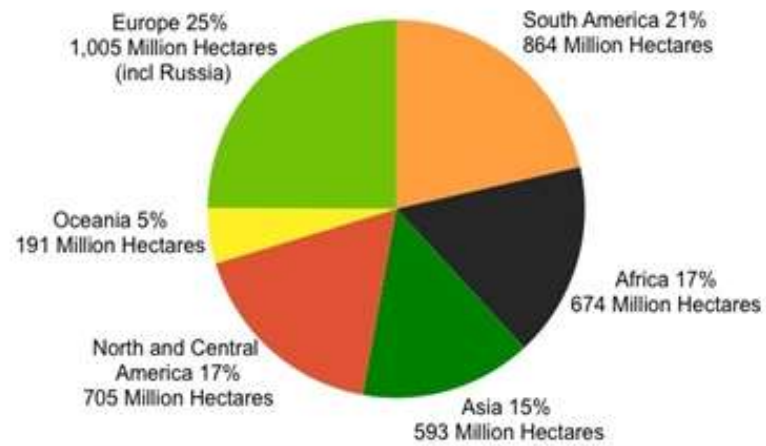

Source: FAO



Market Data

- ▶ External (Third Party) Market Data -> Market Index
- ▶ EUWID - <https://www.euwid.de/en/>
- ▶ S&P Global Platts - <https://www.platts.com/>
- ▶ Bloomberg - <https://www.bloomberg.com/markets>



EUWID Price Watch Packaging Paper Germany Mar 2017

| Prices in €/tonne | Mar 2017 | Feb 2017 | Mar 2016 |
|---|-----------|-----------|-----------|
| Primary fibre corrugated case material | | | |
| Unbleached kraftliner from Scandinavia 175 g | 630 - 690 | 590 - 630 | 590 - 620 |
| Semi-chemical fluting 1) | 570 - 750 | 570 - 750 | 590 - 760 |
| White-top kraftliner 140 g | 845 - 920 | 845 - 920 | 835 - 900 |
| Recycled corrugated case material | | | |
| Schrenz | 480 - 500 | 460 - 485 | 475 - 495 |
| Wellenstoff | 510 - 530 | 490 - 515 | 505 - 525 |
| Testliner II | 540 - 560 | 520 - 545 | 535 - 555 |
| Testliner III | 520 - 540 | 500 - 525 | 515 - 535 |
| White-top testliner, coated | 720 - 760 | 700 - 740 | 700 - 740 |
| White-top testliner, 140 g, ISO 70-75 | 580 - 610 | 560 - 580 | 580 - 600 |

EUWID assumes no liability for the accuracy of pricing information.

1) Prices at the upper end of the range represent Scandinavian primary fibre grades, lower-end prices are quoted for other European grades.

Prices in € per tonne free delivered unless otherwise stated.

Prices and market trends in Europe

EUWID Packaging Markets provides regular research on market developments for the relevant packaging materials and applications. The main focus is on Europe's largest packaging market, Germany. In addition, regular market research is conducted for the neighbouring countries France, Great Britain and Poland.

EUWID Price Watch Commodity Plastics Germany



Grade: Search from: to:



EUWID assumes no liability for the accuracy of pricing information.

Categories of Packaging

- ▶ Paper based boxes (corrugated and solid board)
- ▶ Plastic foils, bags, sacks, films
- ▶ Pallets and wooden packaging
- ▶ Bottles, glass packaging
- ▶ Thermoformed trays
- ▶ Foams
- ▶ EPS & EPP
- ▶ Beeboard (hexacomb)
- ▶ Moulded pulp & Thermoformed Fiber
- ▶ Drums, barrels, cans
- ▶ Special packaging
- ▶ Labels & Printings
- ▶ Other packaging

Solid board (Paperboard)

- ▶ Solid board (carton) is produced in weights from 200 - 650 g/m²; it is multi-plyr paper board typically used for folding cartons
- ▶ One or more coating layers are applied to improve whiteness, smoothness and gloss of paperboard usually by:
 - pigment, which could be china clay, calcium carbonate or titanium dioxide
 - an adhesive or binder as styrene-butadiene emulsions or starches and water
- ▶ Grades of paper according DIN 19303 "Paperboard - Terms and grades,,

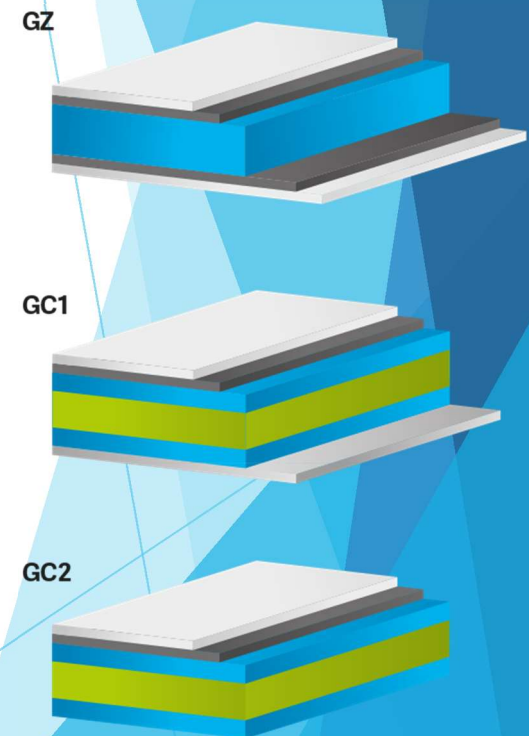

| First letter (surface treatment) | Second letter (main furnish) | Number |
|--|---|--|
| <ul style="list-style-type: none"> •A = cast-coated •G = pigment coated •U = uncoated | <ul style="list-style-type: none"> •Z = bleached virgin chemical pulp •C = virgin mechanical pulp •N = unbleached virgin chemical pulp •T = recycled/secondary fibre with white, cream or brown reverse •D = recycled/secondary fibre with grey back | All except D grades: 1.white reverse side 2.cream reverse side 3.brown reverse side D grades only: 1.bulk ≥ 1.45 cm ² /g 2.1.3 cm ² /g < bulk < 1.45 cm ² /g 3.bulk ≤ 1.3 cm ² /g |

Example: GC1 would be a "pigment coated", "virgin mechanical pulp" board with a "white reverse side". Often the used paperboard type would be folding boxboard (FBB), which was coated on both sides.

Corrugated Board (Cardboard)

- ▶ Corrugated cardboard (fiberboard) is material made of one or more layers of liners with fluted sheet in-between
- ▶ Cardboard is typically used for making corrugated boxes
- ▶ Based on size of fluting we recognize A - G flutes
- ▶ Liners are made of Kraftliner (Kraft Paperboard) with minimum 80% of virgin fibres or Testliner (Recycled Paperboard)
- ▶ The European Federation of Corrugated Board Manufacturers (FEFCO) - www.fefco.org - provide catalogue of designs
- ▶ Corrugated board produced from responsible sources according Forest Stewardship Councils (FSC)

www.fsc.org

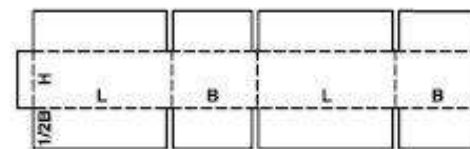
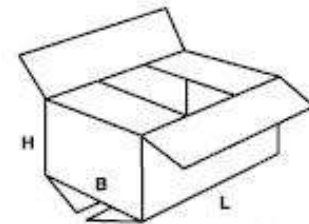

FEFCO 0201

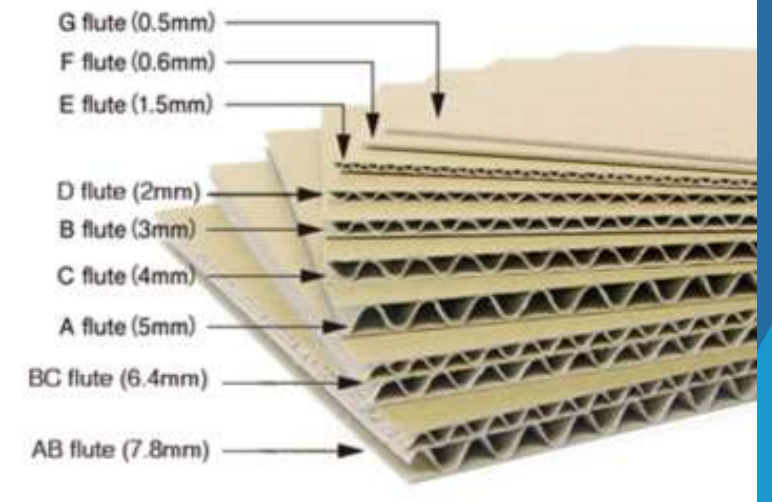

Corrugated Board Cont.

- ▶ Basic cardboard performance is measured by:
 - ECT - Edge Crush Test (kNm) DIN EN ISO 3037
 - BST - Bursting Test or Mullen Test (kPa) DIN 53141 - 1
 - BCT - Box Compression Test or Stacking Crush Test (N) DIN 55440-1
 - Drop test ASTM D5276 - 98(2009)
- ▶ Corrugated board can be used for heavy duty products, pallets
- ▶ Printing - Offset / Flexography
- ▶ Colour systems - CMYK / Pantone

Mullen Burst Test

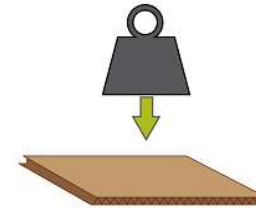

Edge Crush Test

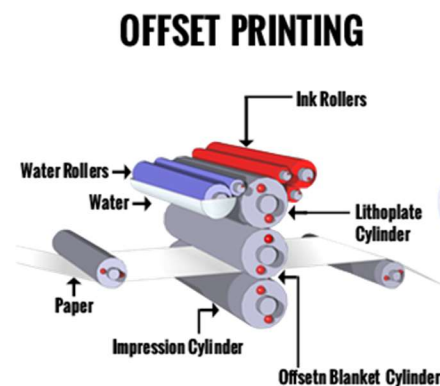
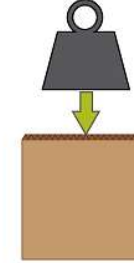

VS

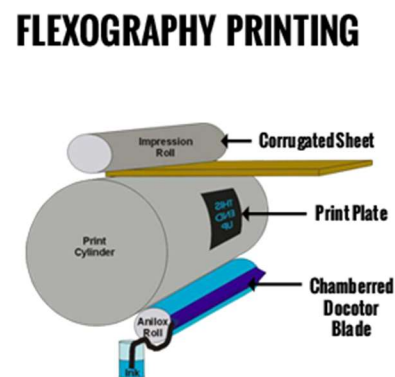

Plastic foils

- ▶ Most common materials for plastic films:
 - Polyethylene PE (LDPE, HDPE, Linear LDPE)
 - Polypropylene PP (BOPP - Biaxially Oriented PP)
 - Polyester PET (BOPET - Biaxially Oriented PET)
 - Nylon
 - Polyvinyl Chloride PVC
- ▶ Production process by casting or blowing (2 - 500 μm)
- ▶ Transparent, coloured, printed, antistatic
- ▶ Stretch films, heat-shrinking films
- ▶ Processed to bags, sacks, bubble foil etc.

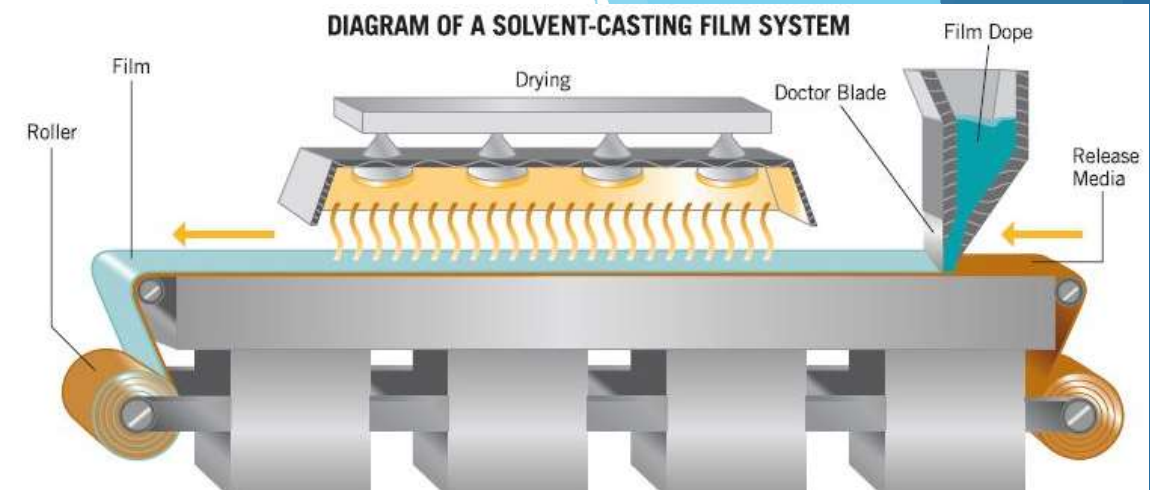

Typical Polyethylene Blown Film Extrusion Line

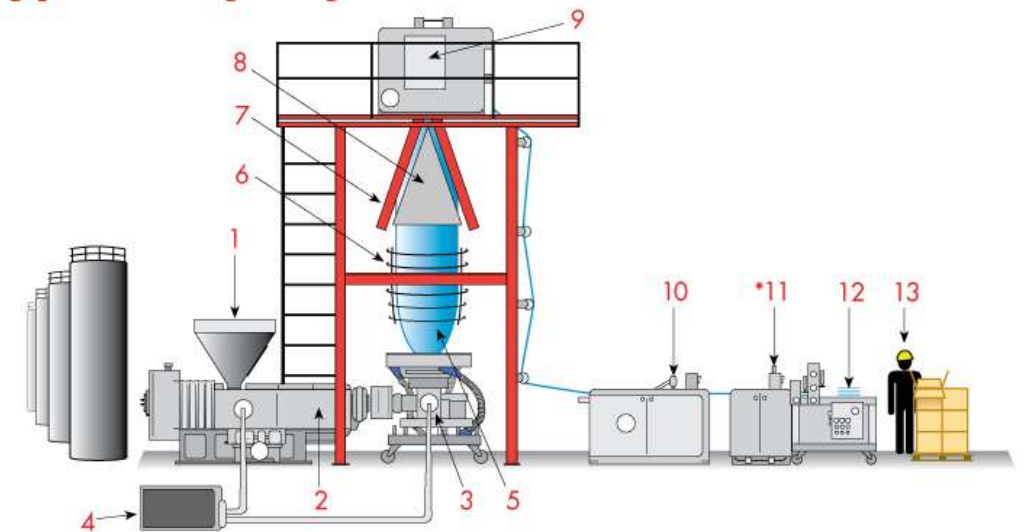

1. **RESIN** is conveyed from railcars, silo or boxes into hoppers which feed the extruder.
2. **EXTRUDER** melts and compresses the polymer and any additives.
3. **DIE** forms the polymer into a ring. Adjustments of the die determine width and gauge of the film bubble.
4. **CHILLER** provides cold water/air to cool polymer as it leaves the die.
5. **BUBBLE OF FILM** is created as the ring of polymer is drawn and cool air is blown into it.
6. **CAGE** stabilizes and holds bubble in place.
7. **FILM BUBBLE** is collapsed by frame into a flat or gusseted tube.
8. **GUSSET BOARDS** push folds into the film if needed.
9. **NIP ROLLS** (behind side plate) continuously pull film from the die.
10. **BAG-MAKER** seals bottom of tube and perforates web.
- *11. **SEPARATOR** separates bags at perforation. SEPARATOR is replaced with a roll **WINDER** during film or bag on roll production.
12. **INDEXER** stacks individual bags and conveys them forward for insertion into cartons.
13. **PACKER** inspects product, places into carton, and palletizes.

Pallets and Wooden Packaging

- ▶ EUR pallet - specified by the European Pallet Association (EPAL), it is a four-way pallet made of wood that is nailed with 78 special nails in a prescribed pattern, size of 1200 x 800 mm
- ▶ Various materials are used for pallets next to wood such as plastics, plywood, chipboard, paper
- ▶ International Standards For Phytosanitary Measures No. 15 (ISPM 15) - describes need to treat wood materials used to ship products between countries
- ▶ Other types of wooden packaging such as crates, special pallets, plywood boxes etc.

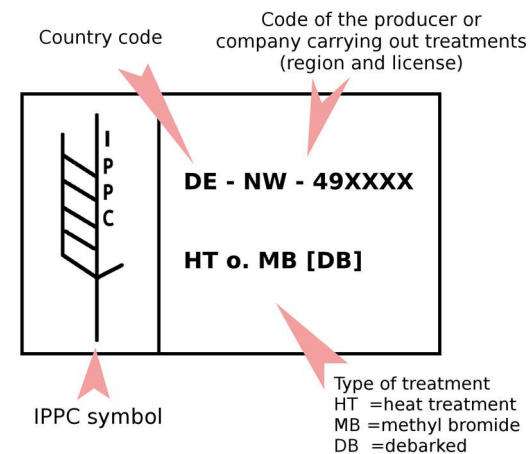

Bottles & Glass Packaging

- ▶ Bottles and jars made from glass in various shapes and sizes used for preserving and packaging drinks, food and perfumes
- ▶ Over 50 billion pcs of bottles is produced in EU per year
- ▶ Glass is formed from a specific type called soda-lime glass, composed of approximately 75% silicon dioxide (SiO_2), sodium oxide (Na_2O) from sodium carbonate (Na_2CO_3), calcium oxide, also called lime (CaO), and several minor additives



Thermofomed trays

- ▶ Thermoforming is a manufacturing process where a plastic sheet is heated to a pliable forming temperature, formed to a specific shape in a mold, and trimmed to create a usable product
- ▶ Various materials could be thermoformed such as:ABS, ACRYLIC, HDPE, HIPS, PC, PET, PP, PVC etc.
- ▶ Materials are used in rolls up to 1,5mm or sheets above 1,5mm
- ▶ Trays in various colours are produced from heated film by vacuum technology on an aluminium tool

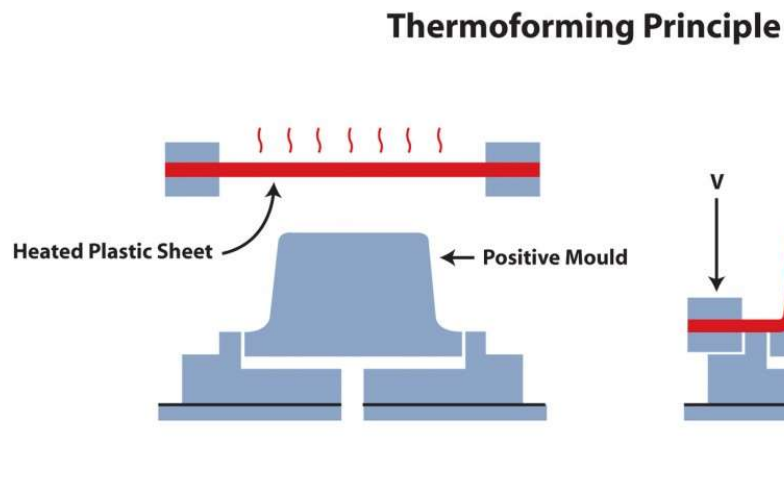

Foams

- ▶ For packaging extremely resistant to vibration, drop and damage we can use foams typically with closed cell structure:
 - PE foam (polyethylene foam)
 - PU foam (polyurethane foam)
 - XPE foam (extruded polyethylene)
- ▶ Foam can be used in rolls, cutted shapes, boards, bags or even as two component chemical; could be laminated

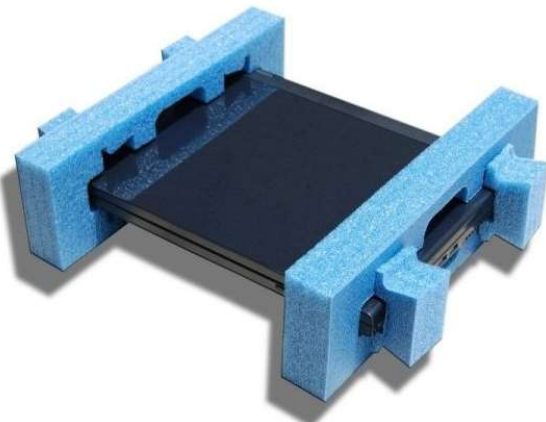

EPS & EPP

- ▶ Expanded Polystyrene and Polypropylen are used for shock resistant packaging which is very light and not absorbing a water
- ▶ Could be supplied as cutted boards and further cutted by wire or moulded in an aluminium tool
- ▶ EPP have memory properties and is used for active protection
- ▶ EPS & EPP have great insulation properties
- ▶ More complex recycling

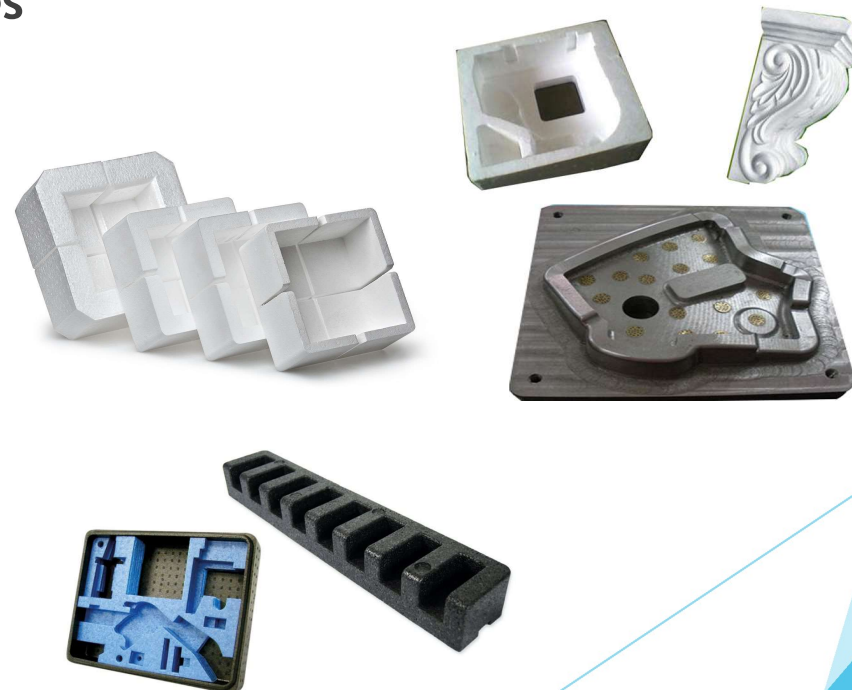
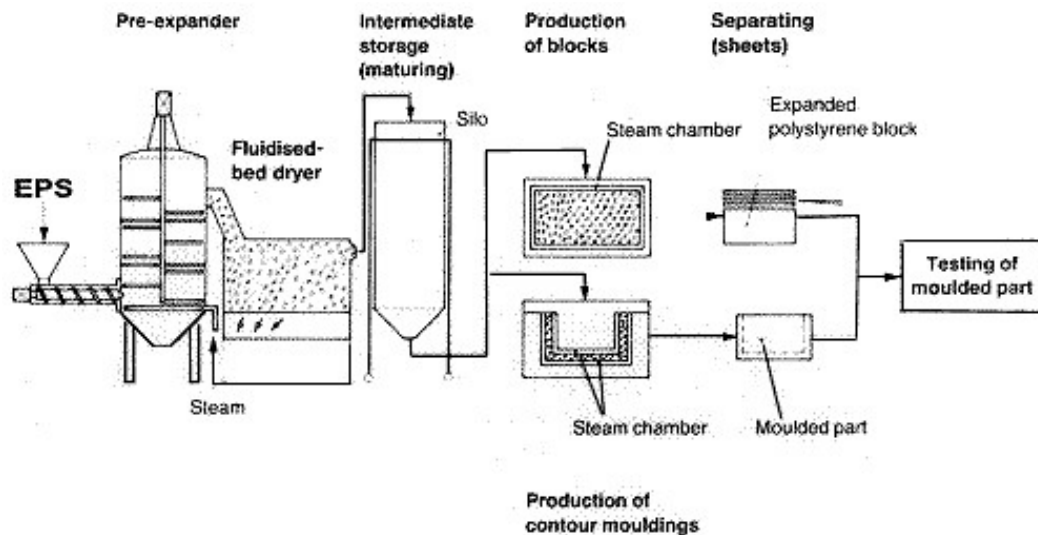

Beeboard (hexacomb)

- ▶ Hexacomb packaging is a paper-based material that offers a unique combination of superior strength whilst being light-weight
- ▶ Features:
 - Lightweight and strong, providing superior compression strength
 - Good shock resistance and cushioning performance
 - Available in a wide range of formats like simple panels, die cut boards, edge and corner protectors, cradles and wedges
 - Easily die cut, assembled, or otherwise fabricated to the shape of the object
 - Highly durable and reusable
 - 100% recyclable and made from a renewable resource

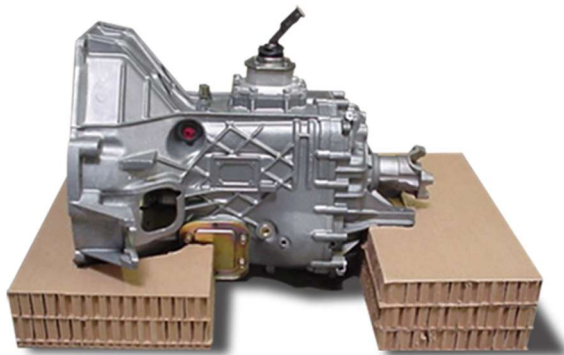

Moulded Pulp & Thermoformed Fibre

- ▶ Made from recycled paperboard and/or newsprint
- ▶ Used for protective packaging or for food service trays and beverage carriers. Other typical uses are end caps, trays, plates, bowls and clamshell containers
- ▶ Typically moulded pulp is less expensive than expanded polystyrene (EPS), vacuumed formed PET and PVC, corrugation, and foams
- ▶ Thermoformed fibre is the highest quality of thin walled products available today made in heated forming molds which presses and densifies the molded products (e.g. www.paperfoam.com)

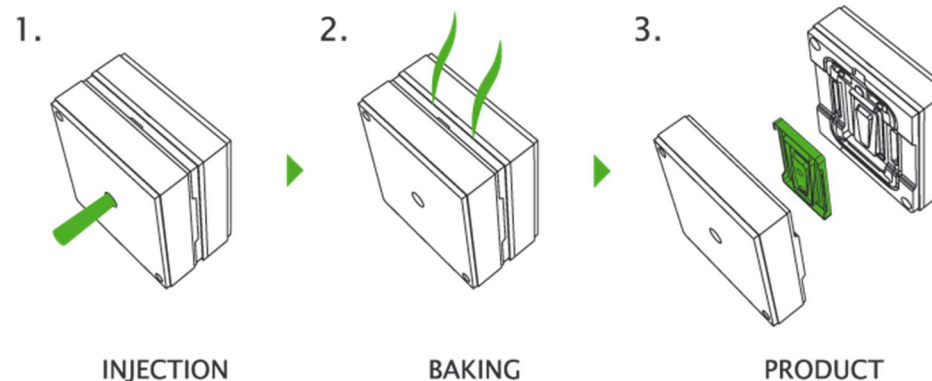

Drums, barrels, cans

- ▶ Drums, barrels and cans are made typically of steel, plastic or aluminium widely used for foods and beverages but also for products such as oil, chemicals, and other liquids
- ▶ Aluminium can (tin can) is produced over 180 billion pcs /year (2015) and is recycled globally with rate around 70%
- ▶ Steel drums are cylindrical containers with a nominal capacity of 200 litres (55 US or 44 imp gal)
- ▶ Some traditional types are replaced by Bag-in-Box (BiB) consists of a strong bladder (plastic bag), usually made of several layers of metallised film or other plastics, seated inside a corrugated box



Special Packaging

- ▶ Hazardous materials
- ▶ Medical packaging
- ▶ Li-on batteries
- ▶ Magnets
- ▶ ESD (electrostatic discharge) packaging
 - Anti-Static (typically pink color)
 - Dissipative
 - Conductive (typically black color)

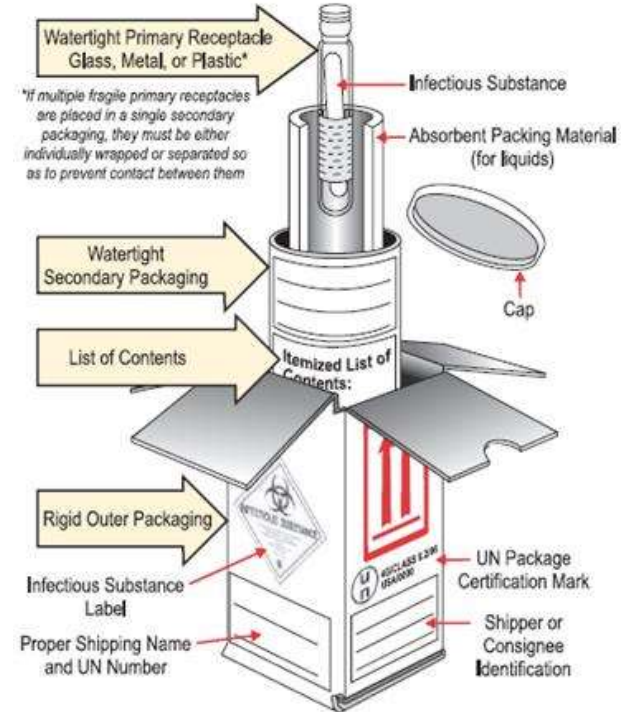

Labels & Printings

- ▶ Label is a piece of paper, polymer, cloth, metal, or other material affixed to a container or product, on which is written or printed information or symbols about the product or item. Information printed directly on a container or article can also be considered labeling
- ▶ Labels with QR codes
- ▶ RFID labels
- ▶ Industrial label printers (ZEBRA, Toshiba, CAB, VIP-Color)
- ▶ Printings e.g. manuals, installation instructions, leaflets



Other Packaging

- ▶ Standard Packaging (Catalogue products)
- ▶ Steel strapping band, PP/PET strapping band
- ▶ Adhesive tapes (pressure-sensitive tape, water activated tape, heat sensitive tape)
- ▶ Void fill (foam, paper, air)
- ▶ Adhesives (natural or synthetic)
- ▶ Pouches (paper, plastic, with bubble foil)
- ▶ Etc.



Food Packaging

- ▶ Food safety is a scientific discipline describing handling, preparation, and storage of food in ways that prevent foodborne illness. This includes a number of routines that should be followed to avoid potentially severe health hazards - (HACCP) Hazard analysis and critical control points
- ▶ Special requirements
 - Barrier protection
 - Shelf life (unfit for use)
 - Temperature and humidity
 - Micro-organism interaction
 - Interaction between food and packaging itself
- ▶ Legislation related to food packaging:
 - Act 258/2000 Coll. (<https://www.zakonyprolidi.cz/cs/2000-258>)
 - Act 37/2001 Coll. (<https://www.zakonyprolidi.cz/cs/2001-37>)
 - Act 186/2003 Coll. (<https://www.zakonyprolidi.cz/cs/2003-186>)

Packaging Logistics

- ▶ Packaging Logistics - An approach which aims at developing packages and packaging systems in order to support the logistical process and to meet customer/user demands - Dominic et al. (2000)

Packaging Cost Trade-Offs with Other Logistics Activities (Lambert et al., 1998)

| Logistics activity | Trade-offs |
|-------------------------------|---|
| <i>Transportation</i> | |
| Increased package information | Decreases shipment delays; increased package information decreases tracking of lost shipments |
| Increased package protection | Decreases damage and theft in transit, but increases package weight and transport costs. |
| Increased standardisation | Decreases handling costs, vehicle waiting time for loading and unloading; increased standardisation; increases modal choices for shipper and decreases need for specialised transport equipment |
| <i>Inventory</i> | |
| Increased product protection | Decreased theft, damage, insurance; increases product availability (sales); increases product value and carrying costs. |
| <i>Warehousing</i> | |
| Increased package information | Decreases order filling time, labour cost. |
| Increased product protection | Increases cube utilisation (stacking), but decreases cube utilisation by increasing the size of the product dimensions. |
| Increased standardisation | Decreases material handling equipment costs. |
| <i>Communications</i> | |
| Increased package information | Decreases other communications about the product such as telephone calls to track down lost shipments. |

Packaging Logistics Cont.

- ▶ Container utilization software - optimization depending on type of packaging and its possibility to stack
- ▶ Proper packaging prevents damage
- ▶ Overseas shipments - special requirements resist humidity (Silicagel, VpCi - Vapor Phase Corrosion Inhibitor, MCI - Migrating Corrosion Inhibitor)
- ▶ Inflatable Cargo Bags - Prevent packages against unwanted movement in containers during transit
- ▶ Air transportation requires special packaging resisting temperature and pressure losses during transit

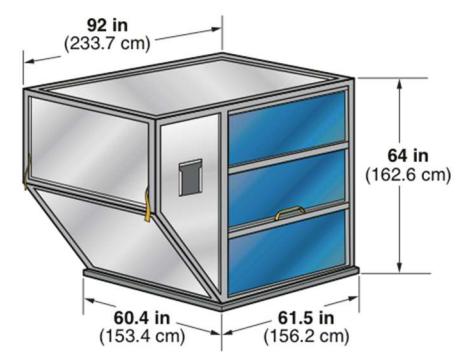
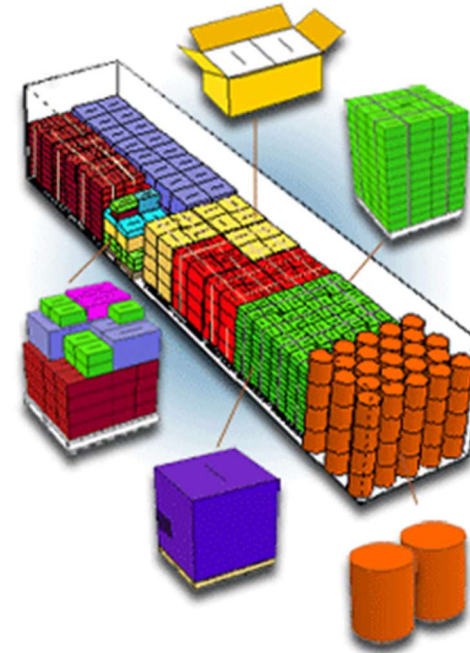

Truck Load Safety

- ▶ ČSN EN 12195 - Load restraining on road vehicles - Safety: design of securing methods (blocking, lashing, and combinations) for securing of loads for surface transport by road vehicles or parts of them (lorries, trailers, containers and swap bodies), including their transport on vessels or by rail and/or combinations thereof
- ▶ VDI 2700 - Securing of loads on road vehicles (German norm)
- ▶ Use antislip pads, sheets, paper to increase friction to prevent package from movement on truck

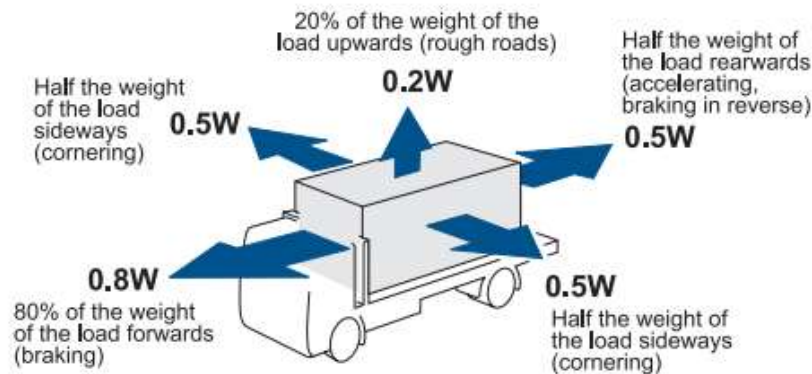

(W = Weight of the load)

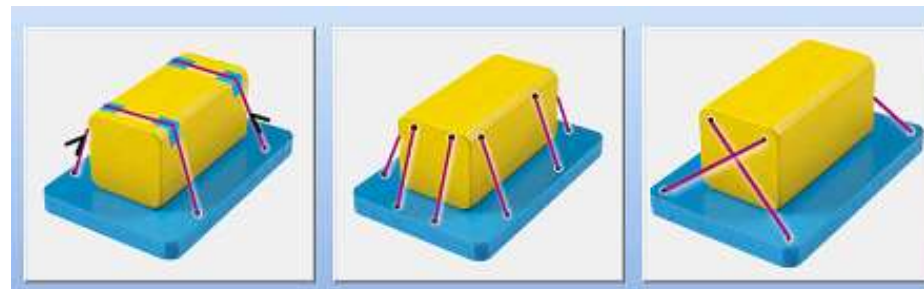

Fig. A.8

LOAD RESTRAINT FORCES

Stretch Film (Stretch Wrap)

- ▶ Stretch wrap material is linear low-density polyethylene or LLDPE, which is produced by copolymerization of ethylene with alpha-olefins, giving rise to enhanced stretch film characteristics, particularly in respect of elongation at break and puncture resistance
- ▶ Many films have about 500% stretch at break but are only stretched to about 100 - 300% in use. Once stretched, the elastic recovery is used to keep the load tight
- ▶ Films from 10 - 23 microns are used providing security of load on pallet
- ▶ Proper combination of stretch and thickness can be optimized
- ▶ Testing according EUMOS 40509-2012: Test method for load unit rigidity



Sustainable Packaging

- ▶ Sustainable Packaging is the development and use of packaging which results in improved sustainability. This involves increased use of life cycle inventory (LCI) and life cycle assessment (LCA) to help guide the use of packaging which reduces the environmental impact and ecological footprint. It includes a look at the whole of the supply chain: from basic function, to marketing, and then through to end of life (LCA) and rebirth.
- ▶ Sustainable packaging:
 - A. Is beneficial, safe & healthy for individuals and communities throughout its life cycle
 - B. Meets market criteria for performance and cost
 - C. Is sourced, manufactured, transported, and recycled using renewable energy
 - D. Optimizes the use of renewable or recycled source materials
 - E. Is manufactured using clean production technologies and best practices
 - F. Is made from materials healthy throughout the life cycle
 - G. Is physically designed to optimize materials and energy
 - H. Is effectively recovered and utilized in biological and/or industrial closed loop cycles

Sustainable Packaging Cont.





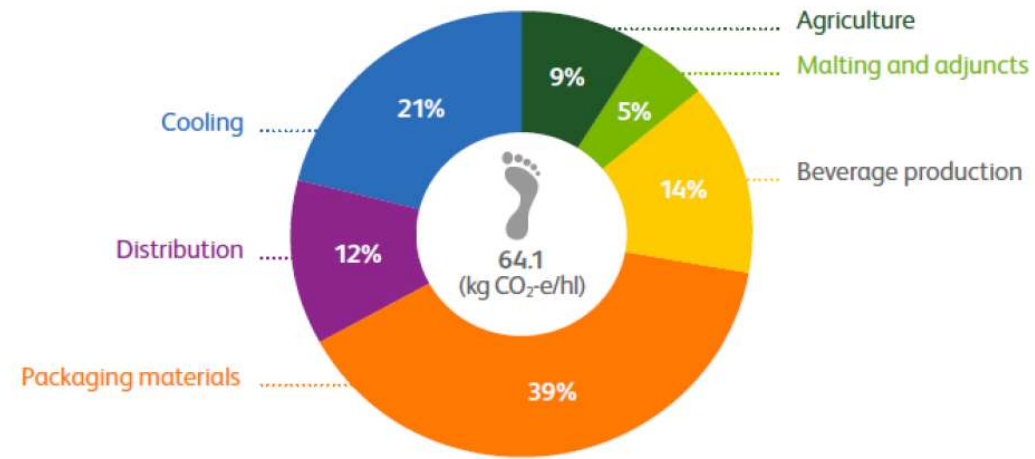









Our impact in 2015, looking at Carbon Footprint

| Area | 2012 Baseline (kg CO ₂ -e/hl) | 2015 (kg CO ₂ -e/hl) | Change (kg CO ₂ -e/hl) |
|--|---|------------------------------------|--------------------------------------|
|  Agriculture | 5.6 | 5.8 | +0.2 |
|  Malting & adjuncts | 4.1 | 3.3 | -0.8 |
|  Beverage production | 11.3 | 8.7 | -2.6 |
|  Packaging material production | 20.9 | 24.7 | +3.8 |
|  Distribution | 7.1 | 7.9 | +0.8 |
|  Cooling | 19.4 | 13.6 | -5.8 |
| Total | 68.4 | 64.1 | -4.3 |



- Calculated on agreed BIER sector guidance (publicly available)
- Results independently verified
- Very similar results can be obtained from our competitors

Recycling of Packaging

| | | | |
|---|---|---|--|
|  1 PETE Polyethylene Terephthalate |  2 HDPE High Density Polyethylene |  3 V Polyvinyl chloride |  4 LDPE Low density polyethylene |
|  5 PP Polypropylene |  6 PS Polystyrene |  7 OTHER Other plastics |  alu Recyclable aluminium |
|  Glass – Please place in bottle bank. Can also be recycled through most doorstep recycling services. |  Recyclable steel |  Capable of being recycled | |
|  Percentage figure in the centre indicates the amount of recycled material |  'Tidyman' symbol. Please dispose of litter responsibly. | | |
|  The 'Green Dot' symbol, appearing on packaging. This symbol does not indicate that the packaging is recyclable, but means that the producer has paid a fee towards recycling of their packaging in certain European countries. |  Forest Stewardship Council approved. This logo indicates that the material or product has been made from FSC certified forests, recycled or other controlled materials. | | |

Global Solid Waste Composition

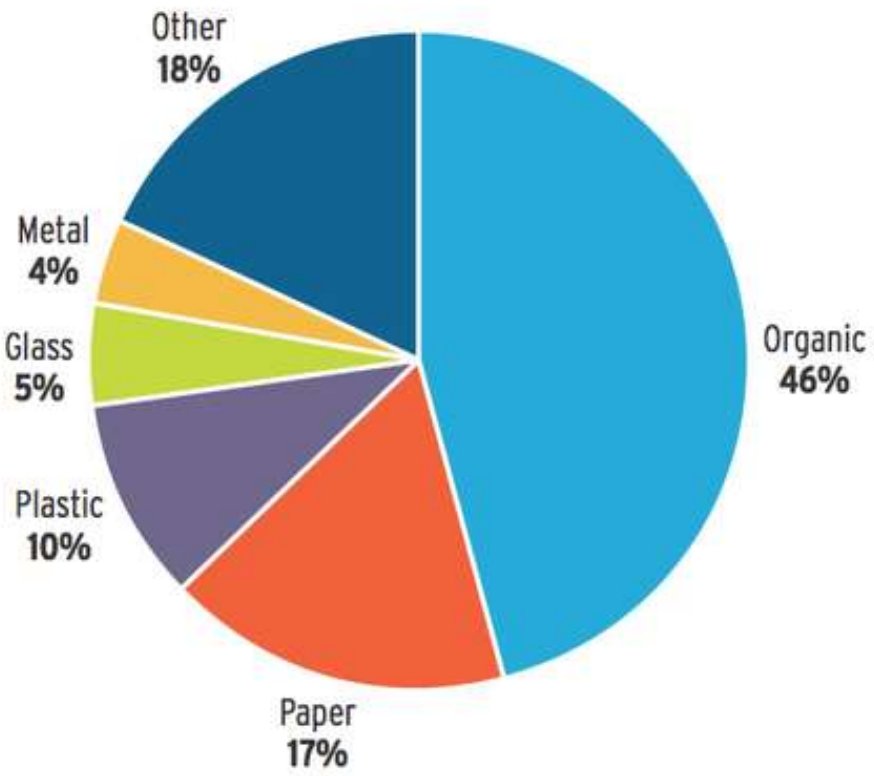

Source: The World Bank - What a Waste: A Global Review of Solid Waste Management (2012)

Recycling of Packaging Cont.

U.S. Packaging Recovery Rates for Selected Materials

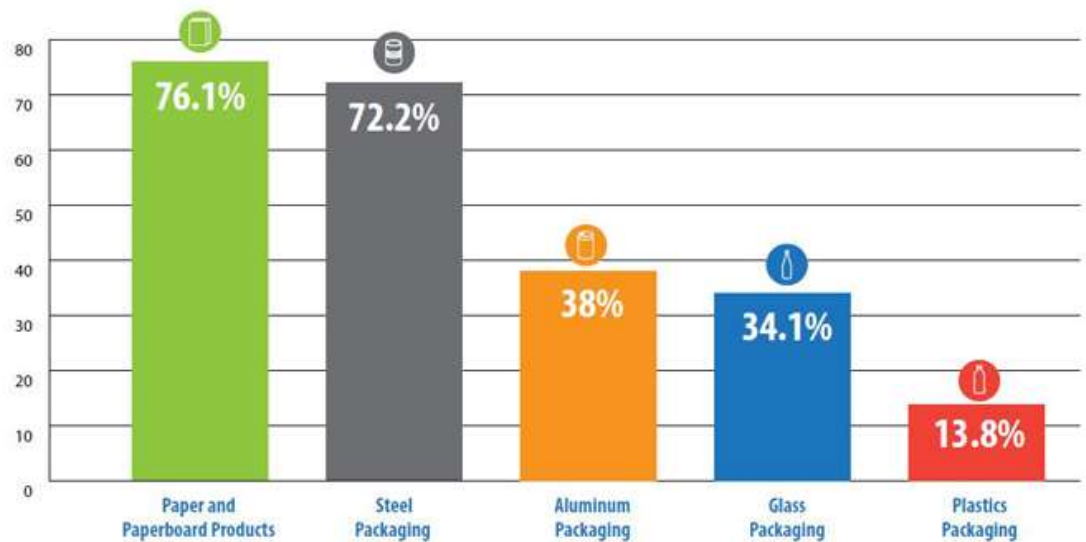

Note that while paper and paperboard packaging rates are high, this is primarily due to high recycling rates for corrugated cardboard; only 25 percent of all other types of paper packaging is recycled.

Source: US Environmental Protection Agency, Municipal Solid Waste Generation, Recycling, and Disposal in the United States: Facts and Figures for 2012

2011 Packaging Recycling Rates in the EU

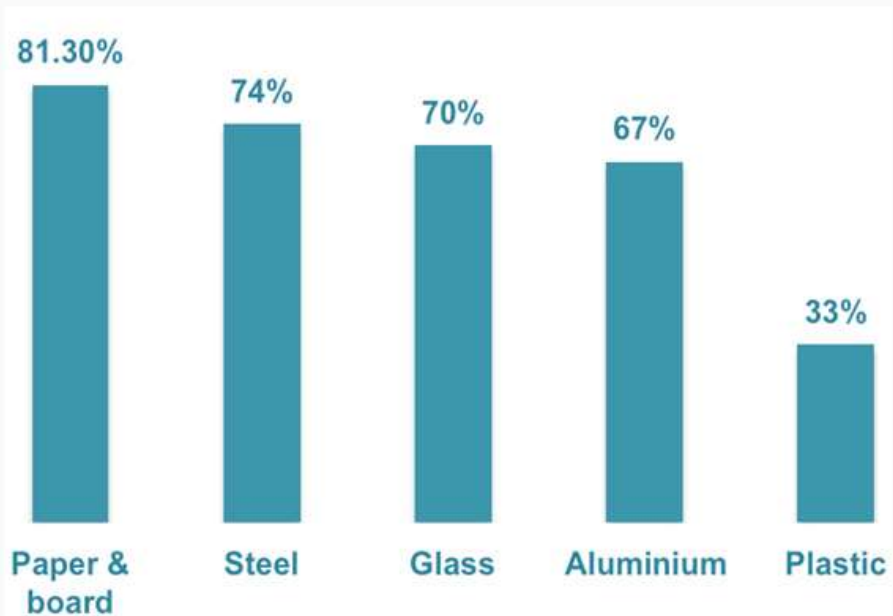

Source: European steel, glass and aluminium packaging associations, CEPI 2012, European Association of Plastics Recycling and Recovery Organisations

European and Czech Packaging Norms

- ▶ Directive 94/62/EC on Packaging and Packaging Waste
- ▶ Packaging Act 477/2001 Coll.
- ▶ Decree No. 116/2002 Coll. on marking returnable packaging
- ▶ Decree No. 641/2004 Coll. on the scope and manner of keeping records of packaging and reporting the data from these records
- ▶ Government order No. 111/2002 Coll. specifying the amount of the deposit on selected types of returnable packaging
- ▶ EKO-KOM (www.ekokom.cz)  EKO-KOM
- ▶ Ministry of the Environment of the Czech Republic:
<http://www.mzp.cz/cz/obaly>
- ▶ Food marking requirements:
 - Act 110/1997 Coll. on food and tobacco products
 - Decree No. 324/1997 Coll. on marking of food and tobacco products, on allowed deviation from amount data of products marked with “e” symbol

Future of Packaging

- ▶ Consumers and corporations are more focused on sustainable packaging
- ▶ Governments increase pressure for higher level of recycling
- ▶ Biodegradable & Compostable packaging is developed based on various natural materials, e.g. Starch (from Corn, Potatoes, etc.), Cellulose films, Casein films
- ▶ Biodegradability - capacity of a substance to be broken down by micro-organisms (not set time scale)
- ▶ Compostability - a managed biodegradation process, through production of a useful compost in a maximum period of 180 days. Conformity to agreed norm required.
- ▶ Compostability norms - EU 13432, US ASTM D 6400



Compostable
Kompostierbar
7P0085

Dincertco, Germany
Also UK, Netherlands & Poland



BPI logo, USA



OK Compost, Belgium

Literature

- Coles, R., Kirwan, M.J.: Food and Beverage Packaging Technology, Wiley, 2011. ISBN 978- 1-4051-8910-1
- Fellows, P.: Food processing technology: principles and practice. Woodhead, Cambridge, 2nd. Ed., 2000. ISBN 0-8493-0887-9
- Han, J.H.: Innovation in food packaging, Elsevier Academic Press, London, 2005. ISBN 0- 12-311632-5
- Moskowitz, H.R., Reisner M., Lawlor, J.B., Deliza, R.: Packaging Research in Food Product Design and Development, Wiley, 2009. ISBN 978-0-8138-1222-9
- Robertson, G.L.: Food packaging: principles and practice. 3rd Ed., Taylor & Francis, 2009. ISBN 978-1-4398-6241-4
- Robertson, G.L.: Food Packaging and Shelf Life; A Practical Guide. Taylor & Francis, 2009. ISBN 978-1-4200-7844-2
- Rooney, M.L.: Active food packaging. Blackie Academic & Professional, London, London, 1995. ISBN 0-7514-0191-9
- Risch, S.J.: Food packaging: testing methods and applications, American Chemical Society, 2000. ISBN 0-8412-36-17-8
- Štencl, J.: Balení potravin. Potravinářský zpravodaj 2/2004 - 4/2005, ročník V. a VI., AGRAL Praha
- DOBIÁŠ, J. - SMEJKALOVÁ, A.: Obaly a obalová technika, Praha, ES ČSU, 2004. ISBN 80-7157-161-X
- KAČEŇÁK, I.: Základy balenia potravin, Bratislava, ARM 333, 2001. ISBN 80-967945-6-6

- How it's made Plastic Bags: <https://www.youtube.com/watch?v=8CfL5xl2N1Q>
- How it's made Glass Bottles : https://www.youtube.com/watch?v=LUF_5zrFG9c